

MAX17019 Evaluation Kit

Evaluates: MAX17019

General Description

The MAX17019 evaluation kit (EV kit) presents the MAX17019 high input-voltage quad-output controller in a typical application setup. The EV kit operates from a 5.5V to 38V input range.

High-voltage controller A is used to generate a 5V rail that serves as supply for the other three rails. These rails are generated by two switching converters (rails B and C), and one push-pull linear regulator (rail D). The supplies for converters B and C and regulator D are accessible but must be less than 6V.

The MAX17019 also has an internal fixed 5V linear regulator capable of supplying 50mA. The EV kit operates at 0.5MHz (VOUTA and VOUTC) and at 1MHz switching frequency (VOUTB). The EV kit has superior line- and load-transient response.

Ordering Information

PART	TYPE
MAX17019EVKIT+	EV Kit

+Denotes lead(Pb)-free and RoHS compliant.

Features

- ◆ **5.5V to 38V Input Range with 42V Transient Capability**
- ◆ **Internal 5V Linear Regulator with 50mA Load Capability**
- ◆ **Output Voltages**
 - VOUTA: 5V Up to 4A Peak Current, Adjustable from 1V to 5.5V**
 - VOUTB: 3.3V Up to 2.5A Peak Current, Adjustable from 0.75V to 4V**
 - VOUTC: 1.2V Up to 4A Peak Current, Adjustable from 0.75V to 4V**
 - VOUTD: 2.5V Up to 2A Current, Adjustable from 0.5V to V_{IND}**
- ◆ **Four Power-Good LEDs Help Monitor the Output Voltages**
- ◆ **0.5MHz Switching Frequency (5V and 1.2V Outputs)**
- ◆ **1MHz Switching Frequency (3.3V Output)**
- ◆ **Independent Enable Inputs and Power-Good Outputs**
- ◆ **Overvoltage and Undervoltage Fault Protection**
- ◆ **Thermal-Fault Protection**
- ◆ **48-Pin (6mm x 6mm) Thin QFN Package**
- ◆ **Fully Assembled and Tested**

Component List

DESIGNATION	QTY	DESCRIPTION
C1, C2	2	4.7µF ±10%, 50V X7R ceramic capacitors (1210) Murata GRM32ER71H475K AVX 12105C475KAT2A
C3	1	22µF, 50V aluminum electrolytic capacitor (6.3mm x 6mm) SANYO 50CE22KX
C4, C11, C20, C24	4	4.7µF ±10%, 6.3V X5R ceramic capacitors (0603) TDK C1608X5R0J475K Murata GRM188R60J475K

DESIGNATION	QTY	DESCRIPTION
C5, C25, C33	3	1µF ±10%, 6.3V X5R ceramic capacitors (0402) TDK C1005X5R0J105K Taiyo Yuden JMK105BJ105MV Murata GRM155R60J105K
C6	1	1µF ±10%, 50V X7R ceramic capacitor (0805) Murata GRM21BR71H105K

For pricing, delivery, and ordering information, please contact Maxim Direct at 1-888-629-4642, or visit Maxim's website at www.maximintegrated.com.

MAX17019 Evaluation Kit

Evaluates: MAX17019

Component List (continued)

DESIGNATION	QTY	DESCRIPTION
C7, C17, C21, C29	4	0.1 μ F \pm 10%, 10V X5R ceramic capacitors (0402) TDK C1005X5R1A104K Taiyo Yuden LMK105BJ104KV Murata GRM155R60J104K
C8, C12, C13	0	Not installed, ceramic capacitors (0402)
C9	1	150 μ F, 6.3V low-ESR capacitor (B case) SANYO 6TPE150MAZB NEC TOKIN PSLB0J157M(35)
C10, C32, C35	0	Not installed, ceramic capacitors (B case)
C14	1	680pF \pm 10%, 50V X7R ceramic capacitor (0402) TDK C1005X7R1H681K Taiyo Yuden UMK105BJ681KW Murata GRM155R71H681K
C15, C28, C36, C37	0	Not installed, ceramic capacitors (0805)
C16, C26, C34	3	10 μ F \pm 20%, 6.3V X5R ceramic capacitors (0805) TDK C2012X5R0J106M or Taiyo Yuden AMK212BJ106MG Murata GRM21BR60J106M
C18, C30	2	1000pF \pm 10%, 50V X7R ceramic capacitors (0402) TDK C1005X7R1H102K Taiyo Yuden UMK105BJ102KW Murata GRM155R71H102K
C19, C22	2	330 μ F, 4V low-ESR capacitors (D case) SANYO 4TPF330ML (12m Ω) NEC TOKIN PSLD0G337M(15)
C23	1	2200pF \pm 10%, 50V X7R ceramic capacitor (0402) TDK C1005X7R1H222K Taiyo Yuden UMK105BJ222KW Murata GRM155R71H222K
C27	1	10 μ F \pm 10%, 6.3V X5R ceramic capacitor (0805) TDK C2012X5R0J106K Murata GRM21BR60J106K

DESIGNATION	QTY	DESCRIPTION
C31	1	0.22 μ F \pm 10%, 10V X5R ceramic capacitor (0402) TDK C1005X5R0J224K Taiyo Yuden JMK105BJ224KV Murata GRM155R60J224K
C38	1	100nF \pm 10%, 50V X7R ceramic capacitor (0603) TDK C1608X7R1H104K Murata GRM188R71H104K
D1	1	250mA, 50V Schottky diode (SOT323) Central Semi CMSSH-3E
D2–D5	4	Green surface-mount LEDs (0805)
JU1	1	4-pin header
L1	1	4.7 μ H, 7A, 20m Ω inductor (7mm x 7mm x 4mm) Würth 744311470
L2	1	2.2 μ H, 13A, 11.5m Ω inductor (7mm x 7mm x 4mm) Würth 744311220
L3	1	1 μ H, 6.8A, 14.2m Ω inductor (5.8mm x 6.2mm x 3mm) TOKO FDV0530-1R0M NEC TOKIN MPLC0525L1R0
N1-A, N1-B	2	Dual 60V n-channel MOSFETs (8 SO) Fairchild HUFA76413DK8T
POKA–POKD, REFIND, SYNC, VTTR	7	Test points
R1	1	10 Ω \pm 5% resistor (0402)
R2, R21, R30, R31	4	0 Ω resistors (0402)
R3, R20, R24, R29	0	Not installed, resistors (0402)
R4	0	Not installed, resistor (0603)
R5	1	40.2k Ω \pm 1% resistor (0603)
R6, R8, R10, R22, R23	5	10k Ω \pm 1% resistors (0603)
R7	1	34k Ω \pm 1% resistor (0603)
R9	1	6.04k Ω \pm 1% resistor (0603)
R11–R14	4	100k Ω \pm 5% resistors (0402)
R15	1	16.5k Ω \pm 5% resistor (0402)
R16–R19	4	4.02k Ω \pm 5% resistors (0603)

MAX17019 Evaluation Kit

Evaluates: MAX17019

Component Suppliers (continued)

DESIGNATION	QTY	DESCRIPTION
R25	1	51Ω ±5% resistor (0402)
R26	1	0.004Ω ±1% 1/4W resistor (1206) Vishay (Dale) WSL12064L000FEA
R27, R28	0	Not installed, resistors—short (PC trace) (0612)
R32	1	82.5kΩ ±5% resistor (0402)
R33	1	1kΩ ±5% resistor (0603)

DESIGNATION	QTY	DESCRIPTION
SW1	1	5-position, low-profile DIP switch
U1	1	Quad output controller (48 TQFN-EP*) Maxim MAX17019ATM+
—	1	PCB: MAX17019 EVALUATION KIT+

*EP = Exposed pad.

Component Suppliers

SUPPLIER	PHONE	WEBSITE
Central Semiconductor Corp.	631-435-1110	www.centalsemi.com
Fairchild Semiconductor	888-522-5372	www.fairchildsemi.com
Murata Americas	770-436-1300	www.murataamericas.com
NEC TOKIN America, Inc.	408-324-1790	www.nec-tokinamerica.com
SANYO NA Corp.	619-661-6835	www.sanyodevice.com
Taiyo Yuden	800-348-2496	www.t-yuden.com
TDK Corp.	847-803-6100	www.component.tdk.com
TOKO America, Inc.	847-297-0070	www.tokoam.com
Vishay	402-563-6866	www.vishay.com
Würth Elektronik GmbH & Co. KG	201-785-8800	www.we-online.com

Note: Indicate that you are using the MAX17019 when contacting these component suppliers.

Quick Start

Recommended Equipment

- MAX17019 EV kit
- 5.5V to 38V DC power supply
- Four digital multimeters (DMMs)
- 100MHz dual-trace oscilloscope

Procedure

The MAX17019 EV kit is a fully assembled and tested surface-mount board. Follow the steps below to verify board operation. **Caution: Do not turn on the power supply until all connections are completed.**

- 1) Ensure that the circuit is connected correctly to the power supply and dummy loads prior to applying any power.
- 2) Set SW1 (1, 10) to the off position ($\overline{\text{SHDN}} = \text{VBATT}$, MAX17019 disabled).
Set SW1 (2, 9) to the on position (ONA = VDD, VOUTA enabled).
Set SW1 (3, 8) to the on position (ONB = VDD, VOUTB enabled).

Set SW1 (4, 7) to the on position (ONC = VDD, VOUTC enabled).

Set SW1 (5, 6) to the on position (OND = VDD, VOUTD enabled).

- 3) Connect the first DMM across the VOUTA and GND pads.
- 4) Connect the second DMM across the VOUTB and GND pads.
- 5) Connect the third DMM across the VOUTC and GND pads.
- 6) Connect the fourth DMM across the VOUTD and GND pads.
- 7) Turn on the power supply and adjust input voltage to 12V.
- 8) Set SW1 (1, 10) to the on position ($\overline{\text{SHDN}} = \text{VBATT}$, MAX17019 activated).
- 9) All LEDs should be lit; verify that the output voltages are VOUTA = 5V, VOUTB = 3.3V, VOUTC = 1.2V, and VOUTD = 2.5V.

MAX17019 Evaluation Kit

Evaluates: MAX17019

Troubleshooting

Output Rails Do Not Come Up

The MAX17019 output rails incorporate undervoltage shutoff and stay off until the corresponding ON_ switch is toggled. Make sure the supplies to the rails are high enough to allow it to regulate. Also check if the current limit on the power supply is set high enough for the initial startup current spike.

Current Capability Seems Too Low

The current capability listed in the data sheet is the peak ripple current. DC current may be 30% lower. If the supply rails are cascaded, allow for lower external load currents. Also check the current limit on the power supply.

Load Regulation Seems Low

The control algorithm in the MAX17019 utilizes a load-line architecture. This architecture improves stability and step response at the cost of a weaker load response. It may be necessary to set the output voltage higher to fulfill accuracy requirements.

Detailed Description of Hardware

5V Output-Voltage Setting (VOUTA)

The MAX17019 EV kit is shipped with FBA connected to resistors R5 and R6, which sets the VOUTA voltage to 5V.

To change the output voltage to a value between 1V and 5.5V, remove R5. Calculate R5 using the following equation:

$$R5 = R6 \times \left(\frac{V_{OUTA}}{V_{FBA}} - 1 \right)$$

where $V_{FBA} = 1V$ and $R6 = 10k\Omega \pm 1\%$. For an output voltage of 1V, place a short across R5 and leave R6 open.

3.3V Output-Voltage Setting (VOUTB)

The MAX17019 EV kit is shipped with FBB connected to resistors R7 and R8, which sets the VOUTB voltage to 3.3V.

To change the output voltage to a value between 0.75V and 4V, remove R7. Calculate R7 using the following equation:

$$R7 = R8 \times \left(\frac{V_{OUTB}}{V_{FBB}} - 1 \right)$$

where $V_{FBB} = 0.75V$ and $R8 = 10k\Omega \pm 1\%$. For an output voltage of 0.75V, place a short across R7 and leave R8 open.

1.2V Output-Voltage Setting (VOUTC)

The MAX17019 EV kit is shipped with FBC connected to resistors R9 and R10, which sets the VOUTC voltage to 1.2V.

To change the output voltage to a value between 0.75V and 4V, remove R9. Calculate R9 using the following equation:

$$R9 = R10 \times \left(\frac{V_{OUTC}}{V_{FBC}} - 1 \right)$$

where $V_{FBC} = 0.75V$ and $R10 = 10k\Omega \pm 1\%$. For an output voltage of 0.75V, place a short across R9 and leave R10 open.

2.5V Output-Voltage Setting (VOUTD)

The MAX17019 EV kit is shipped with FBD connected to resistors R22 and R23, which sets the VOUTD voltage to 2.5V. The voltage at FBD tracks the REFIND voltage, which is pulled up to the 1.25V reference output voltage VREF through resistor R33.

To change the VOUTD output voltage to a value between 0.5V and V_{IND} , remove R22. Calculate R22 using the following equation:

$$R22 = R23 \times \left(\frac{V_{OUTD}}{V_{FBD}} - 1 \right)$$

where $V_{FBD} = V_{REFIND} = 1.25V$ and $R23 = 10k\Omega \pm 1\%$.

Make sure the internal losses $P_{REGD} = (V_{IND} - V_{OUTD}) \times I_{OUTD}$ do not violate the thermal limits of the IC (refer to the MAX17019 IC data sheet).

Independent Enable Inputs and Power-Good Outputs

Separate enable inputs and independent open-drain power-good outputs allow flexible power sequencing. Switch SW1 is provided to control the ONA-OND enable inputs and the SHDN input. Table 1 summarizes SW1's function.

To display which of the outputs are in regulation, power-good LED indicators D2-D5 are also provided.

MAX17019 Evaluation Kit

Evaluates: MAX17019

Table 1. Switch SW1 Settings

SW1		PIN CONTROL	MAX17019 OUTPUT
SW1-A	Off	$\overline{\text{SHDN}}$ pin is connected to GND	Shutdown mode (all outputs disabled)
	On	$\overline{\text{SHDN}}$ pin is connected to VBATT	MAX17019 enabled (all outputs depend on SW1 position settings)
SW1-B	Off	ONA pin is connected to GND	Disables VOUTA, VOUTA = 0V
	On	ONA pin is connected to VDD	Enables VOUTA, VOUTA = 5V
SW1-C	Off	ONB pin is connected to GND	Disables VOUTB, VOUTB = 0V
	On	ONB pin is connected to VDD	Enables VOUTB, VOUTB = 3.3V
SW1-D	Off	ONC pin is connected to GND	Disables VOUTC, VOUTC = 0V
	On	ONC pin is connected to VDD	Enables VOUTC, VOUTC = 1.2V
SW1-E	Off	OND pin is connected to GND	Disables VOUTD, VOUTD = 0V
	On	OND pin is connected to VDD	Enables VOUTD, VOUTD = 2.5V

Note: As configured, the MAX17019 EV kit is shipped with all SW1 settings in the off position.

Frequency Selection (FREQ)

The switching frequency of the MAX17019 kit can be adjusted by removing resistor R24 and installing a short across resistors R20 or R21. As configured, the MAX17019 EV kit operates at 0.5MHz (VOUTA and VOUTC) and at 1MHz switching frequency (VOUTB). When changing the switching frequency, refer to the MAX17019 IC data sheet for the proper component selections and calculations for the inductors and output capacitors.

Table 2. Switching-Frequency Selection

FREQ PIN	SWITCHING FREQUENCY		
	VOUTA	VOUTB	VOUTC
Connected to VDD through open resistor R24	250kHz	500kHz	250kHz
Connected to REF through open resistor R20	375kHz	750kHz	375kHz
Connected to GND through 0 Ω resistor R21*	500kHz	1MHz	500kHz

*Default position.

Table 3. Jumper JU1 Functions

SHUNT POSITION	IND CONNECTS TO REGULATOR
1-2*	VOUTA
1-3	VOUTB
1-4	VOUTC (only for custom setups with VOUTC > VOUTD)

*Default position.

Source/Sink Linear-Regulator Input (IND)

The MAX17019 EV kit includes a jumper (JU3) to select which of the step-down switching regulators (VOUTA–VOUTC) powers the push-pull linear regulator (VOUTD).

By default, the 2.5V VOUTD output stage is powered from the IND input when a shunt is installed across jumper JU1 pins 1-2 or pins 1-3, but not pins 1-4.

A user may want to set up VOUTC to 2.5V and VOUTD to 1.25V for DDR RAM use. VOUTC can be set for 2.5V using the equation from the *1.2V Output-Voltage Setting (VOUTC)* section. For DDR RAM applications, VOUTD can also track the REFIND voltage to provide a 1.25V output. Remove R23 and replace R22 with a 0 Ω resistor. Under these two cases, JU1 may be configured to all three settings.

MAX17019 Evaluation Kit

Evaluates: MAX17019

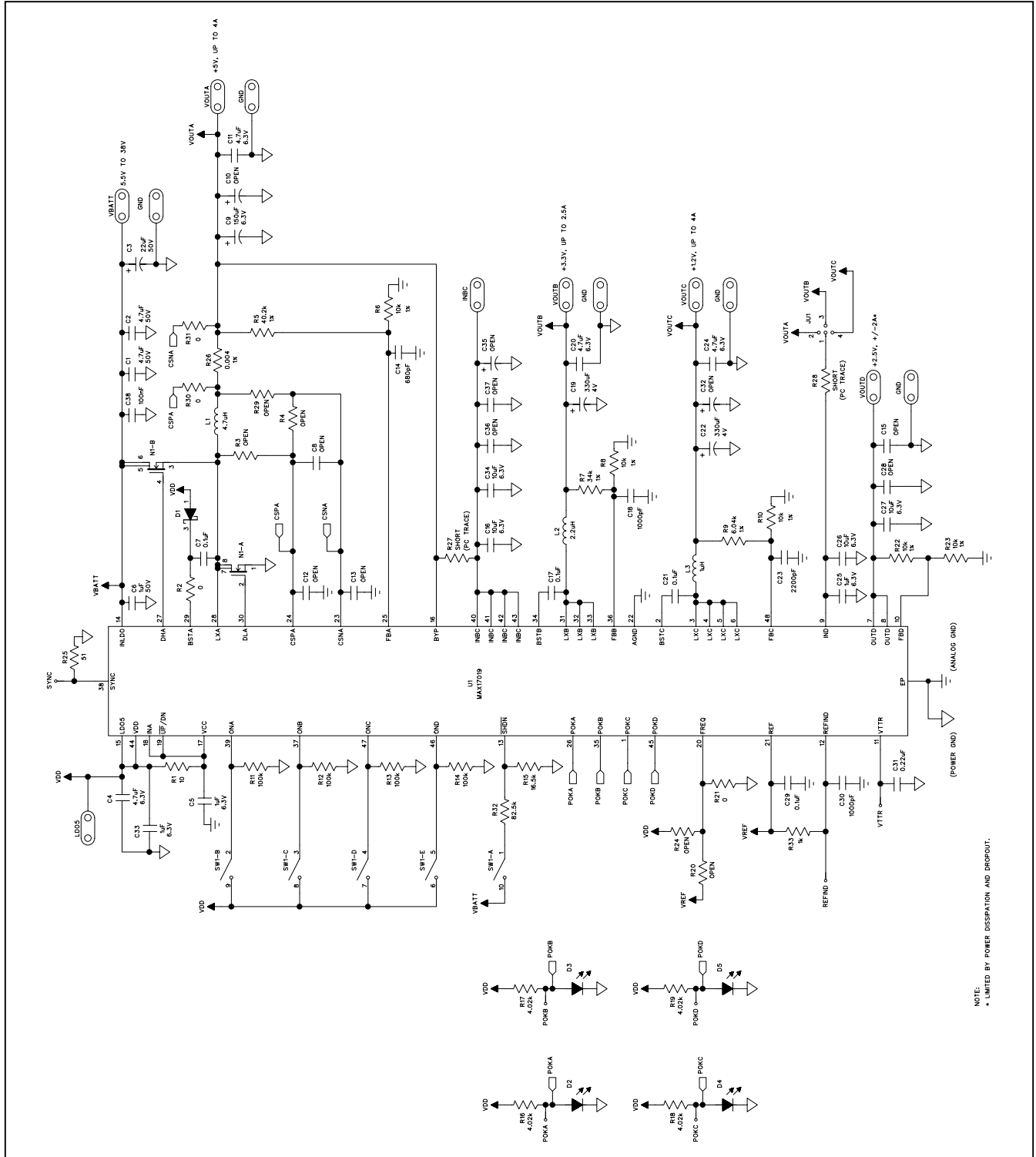

Figure 1. MAX17019 EV Kit Schematic

MAX17019 Evaluation Kit

Evaluates: MAX17019

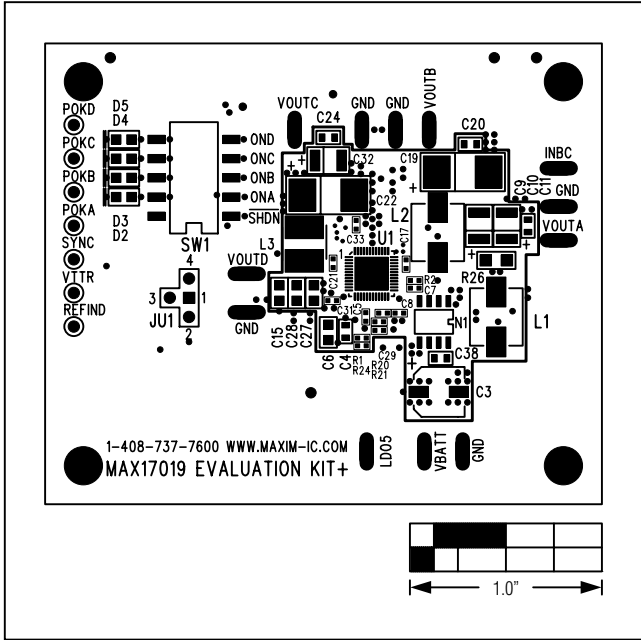

Figure 2. MAX17019 EV Kit Component Placement Guide—Component Side

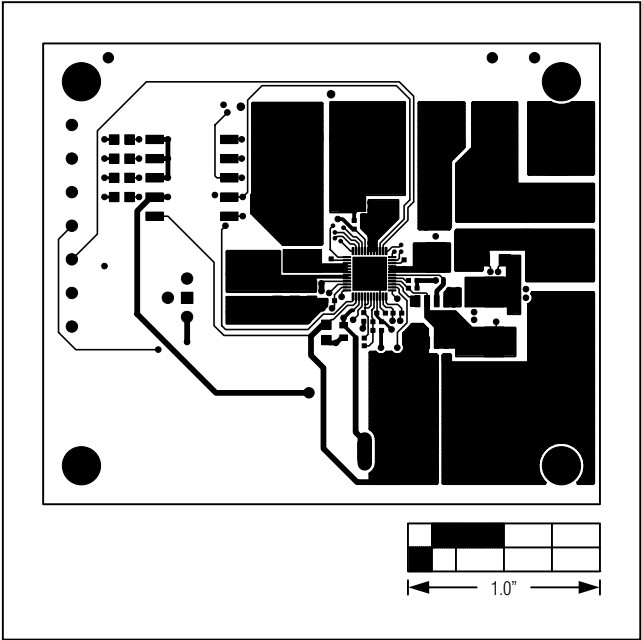

Figure 3. MAX17019 EV Kit PCB Layout—Component Side

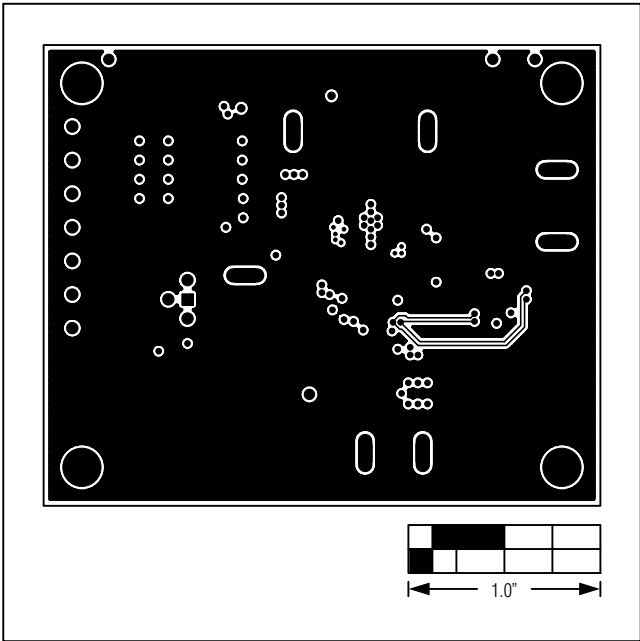

Figure 4. MAX17019 EV Kit PCB Layout—Layer 2

MAX17019 Evaluation Kit

Evaluates: MAX17019

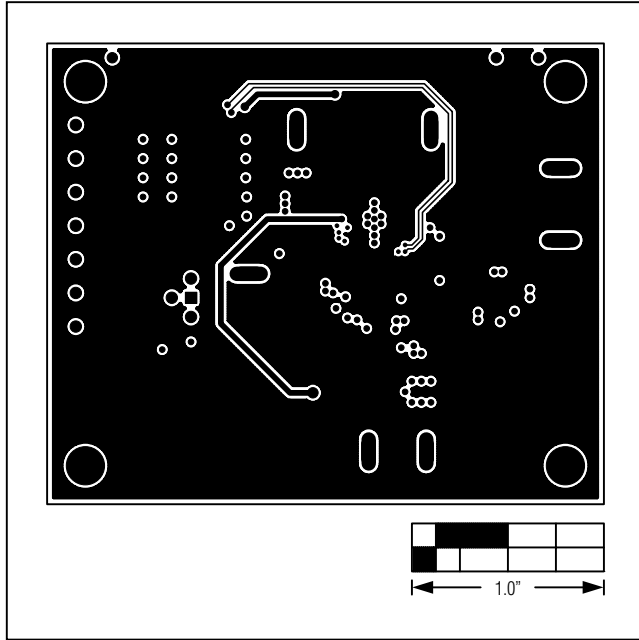

Figure 5. MAX17019 EV Kit PCB Layout—Layer 3

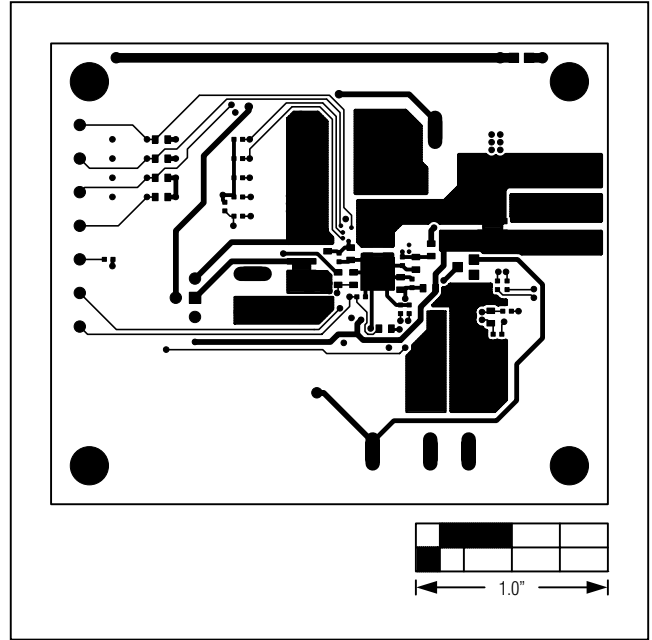

Figure 6. MAX17019 EV Kit PCB Layout—Solder Side

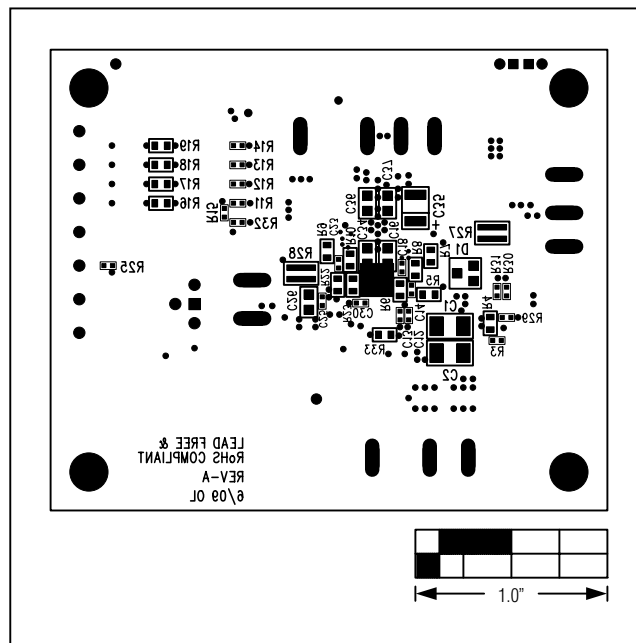

Figure 7. MAX17019 EV Kit Component Placement Guide—Solder Side

MAX17019 Evaluation Kit

Evaluates: MAX17019

Features

REVISION NUMBER	REVISION DATE	DESCRIPTION	PAGES CHANGED
0	9/09	Initial release	—
1	4/15	Deleted automotive reference from the <i>General Description</i> section	1



Maxim Integrated cannot assume responsibility for use of any circuitry other than circuitry entirely embodied in a Maxim Integrated product. No circuit patent licenses are implied. Maxim Integrated reserves the right to change the circuitry and specifications without notice at any time. The parametric values (min and max limits) shown in the Electrical Characteristics table are guaranteed. Other parametric values quoted in this data sheet are provided for guidance.

Maxim Integrated 160 Rio Robles, San Jose, CA 95134 USA 1-408-601-1000

9