

# CGA2B2C0G1H820J050BD

TDK Item Description : CGA2B2C0G1H820JT\*\*\*B



Equivalent C1005C0G1H820J for Automotive

## Application & Main Feature

Automotive Grade ( Conductive Epoxy Application )

## Series

CGA2(1005) [EIA CC0402]

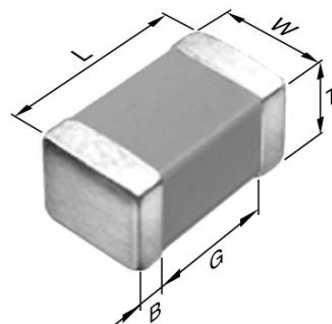

## Dimensions

L 1.00mm +/-0.15mm  
 W 0.50mm +/-0.1mm  
 T 0.50mm +/-0.1mm  
 B 0.10mm Min.  
 G 0.30mm Min.

## Temperature Characteristic

C0G (-55 to 125 degC 0+/-30ppm/degC)

## Rated Voltage

1H (50Vdc)

## Capacitance

82pF

## Capacitance Tolerance

J (+/-5%)

## Q Factor

1000 Min.

## Insulation Resistance

10Gohm Min.

## AEC-Q200

Yes

**|Z|, ESR vs. Freq. Characteristics**

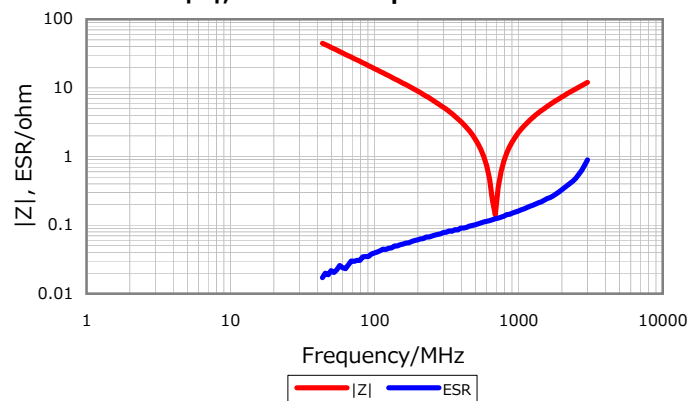

**DC Bias Characteristic**



**Cap. vs. Freq. Characteristic**

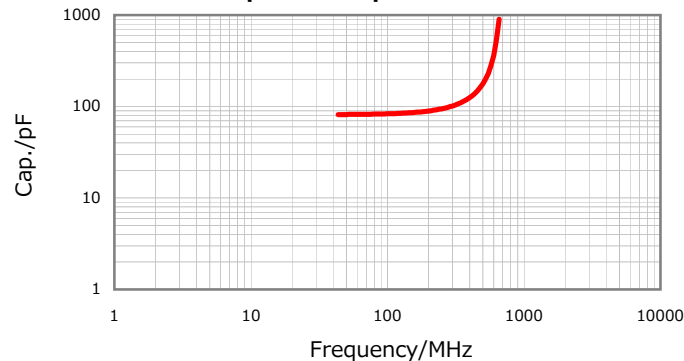

**Temperature Characteristics**



Characterization Sheet ( Multilayer Ceramic Chip Capacitors )



All specifications are subject to change without notice.

January 4, 2016