

# PBSS4160K

60 V, 1 A NPN low  $V_{CEsat}$  (BISS) transistor

Rev. 02 — 18 July 2005

Product data sheet

## 1. Product profile

### 1.1 General description

NPN low  $V_{CEsat}$  Breakthrough in Small Signal (BISS) transistor in a SOT346 (SC-59A) Surface Mounted Device (SMD) plastic package.

PNP complement: PBSS5160K.

### 1.2 Features

- Low collector-emitter saturation voltage  $V_{CEsat}$
- High collector current capability:  $I_C$  and  $I_{CM}$
- High collector current gain ( $h_{FE}$ ) at high  $I_C$
- High efficiency due to less heat generation
- Smaller required Printed-Circuit Board (PCB) area than for conventional transistors

### 1.3 Applications

- High voltage DC-to-DC conversion
- High voltage MOSFET gate driving
- High voltage motor control
- High voltage power switches (e.g. motors, fans)
- Automotive applications

### 1.4 Quick reference data

Table 1: Quick reference data

| Symbol      | Parameter                               | Conditions                    | Min | Typ | Max | Unit       |
|-------------|---|-------------------------------|-----|-----|-----|------------|
| $V_{CEO}$   | collector-emitter voltage               | open base                     | -   | -   | 60  | V          |
| $I_C$       | collector current (DC)                  |                               | [1] | -   | 1   | A          |
| $I_{CM}$    | peak collector current                  | single pulse; $t_p \leq 1$ ms | -   | -   | 2   | A          |
| $R_{CEsat}$ | collector-emitter saturation resistance | $I_C = 1$ A; $I_B = 100$ mA   | [2] | 230 | 280 | m $\Omega$ |

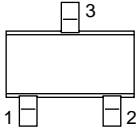
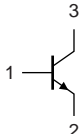
[1] Device mounted on a ceramic PCB,  $Al_2O_3$ , standard footprint.

[2] Pulse test:  $t_p \leq 300$   $\mu$ s;  $\delta \leq 0.02$ .

**PHILIPS**

## 2. Pinning information

Table 2: Pinning

| Pin | Description | Simplified outline  | Symbol  |
|-----|-------------|---|---|
| 1   | base        |  |  |
| 2   | emitter     |   |   |
| 3   | collector   |   |   |

*sym021*

## 3. Ordering information

Table 3: Ordering information

| Type number | Package |  |         |
|-------------|---------|--|---------|
|             | Name    | Description                              | Version |
| PBSS4160K   | SC-59A  | plastic surface mounted package; 3 leads | SOT346  |

## 4. Marking

Table 4: Marking codes

| Type number | Marking code |
|-------------|--------------|
| PBSS4160K   | XB           |

## 5. Limiting values

**Table 5: Limiting values**

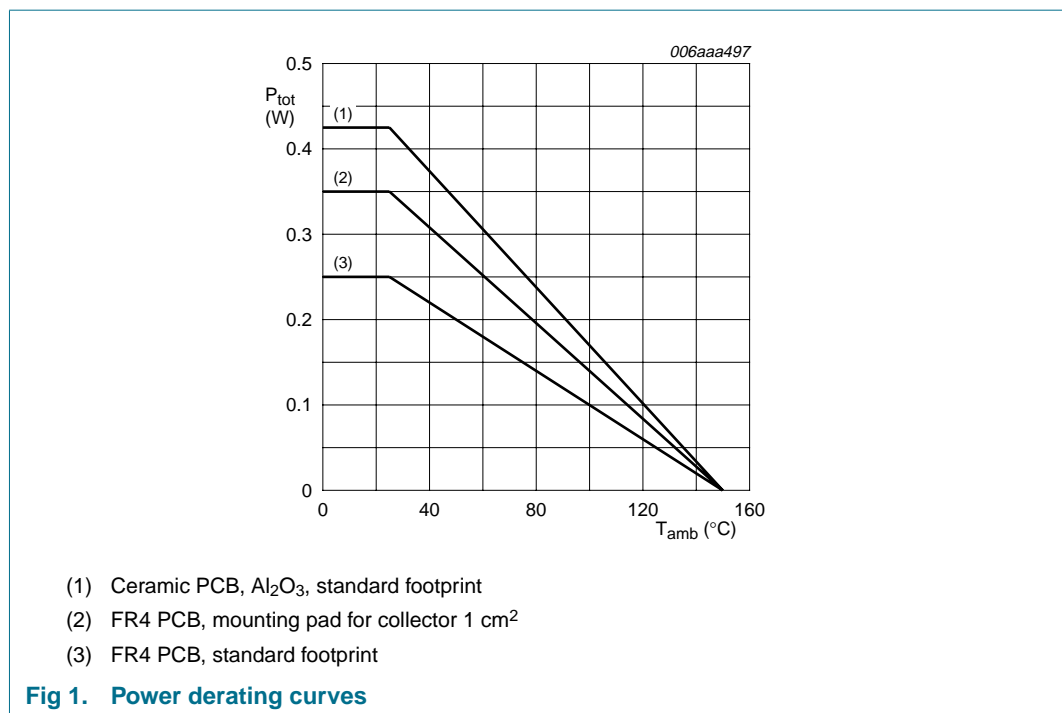
In accordance with the Absolute Maximum Rating System (IEC 60134).

| Symbol    | Parameter                 | Conditions                    | Min   | Max  | Unit |
|-----------|---------------------------|-------------------------------|-------|------|------|
| $V_{CBO}$ | collector-base voltage    | open emitter                  | -     | 80   | V    |
| $V_{CEO}$ | collector-emitter voltage | open base                     | -     | 60   | V    |
| $V_{EBO}$ | emitter-base voltage      | open collector                | -     | 5    | V    |
| $I_C$     | collector current (DC)    |                               | [1] - | 750  | mA   |
|           |                           |                               | [2] - | 930  | mA   |
|           |                           |                               | [3] - | 1    | A    |
| $I_{CM}$  | peak collector current    | single pulse; $t_p \leq 1$ ms | -     | 2    | A    |
| $I_B$     | base current (DC)         |                               | -     | 300  | mA   |
| $I_{BM}$  | peak base current         | single pulse; $t_p \leq 1$ ms | -     | 1    | A    |
| $P_{tot}$ | total power dissipation   | $T_{amb} \leq 25$ °C          | [1] - | 250  | mW   |
|           |                           |                               | [2] - | 350  | mW   |
|           |                           |                               | [3] - | 425  | mW   |
| $T_j$     | junction temperature      |                               | -     | 150  | °C   |
| $T_{amb}$ | ambient temperature       |                               | -65   | +150 | °C   |
| $T_{stg}$ | storage temperature       |                               | -65   | +150 | °C   |

[1] Device mounted on an FR4 PCB, single-sided copper, tin-plated and standard footprint.

[2] Device mounted on an FR4 PCB, single-sided copper, tin-plated, mounting pad for collector 1 cm<sup>2</sup>.

[3] Device mounted on a ceramic PCB, Al<sub>2</sub>O<sub>3</sub>, standard footprint.

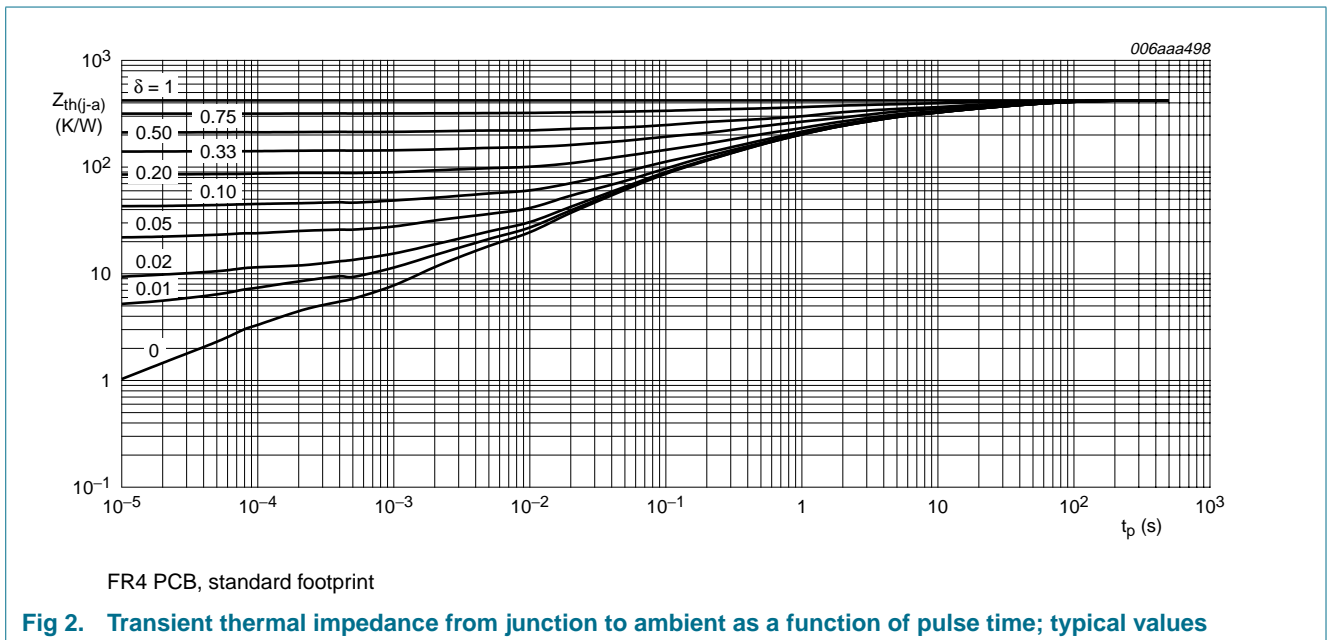


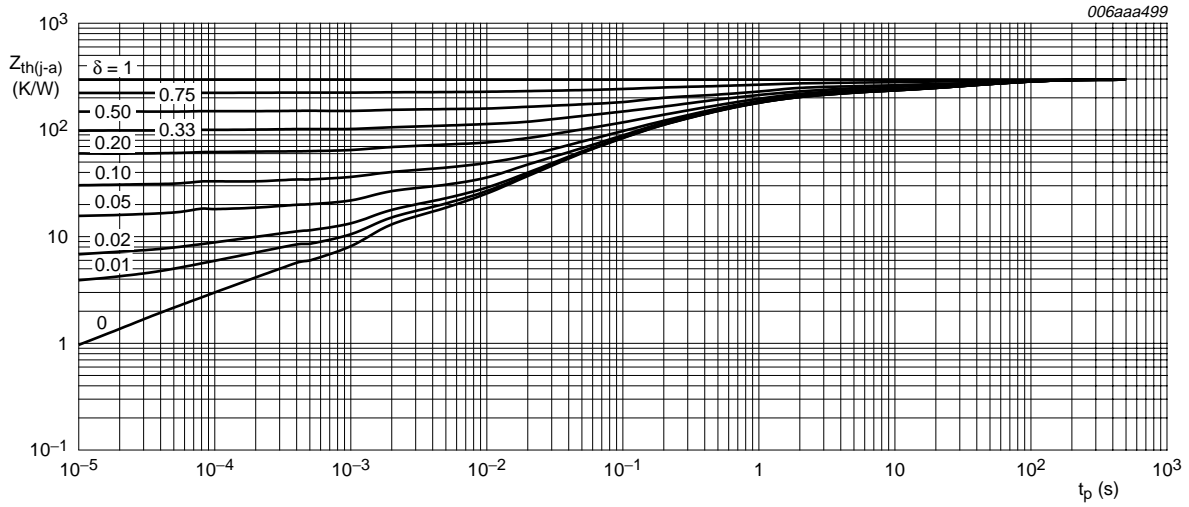
## 6. Thermal characteristics

**Table 6: Thermal characteristics**

| Symbol         | Parameter  | Conditions  | Min | Typ | Max | Unit |     |
|----------------|--|-------------|-----|-----|-----|------|-----|
| $R_{th(j-a)}$  | thermal resistance from junction to ambient      | in free air | [1] | -   | -   | 500  | K/W |
|                |  |             | [2] | -   | -   | 357  | K/W |
|                |  |             | [3] | -   | -   | 294  | K/W |
| $R_{th(j-sp)}$ | thermal resistance from junction to solder point |             | -   | -   | 150 | K/W  |     |

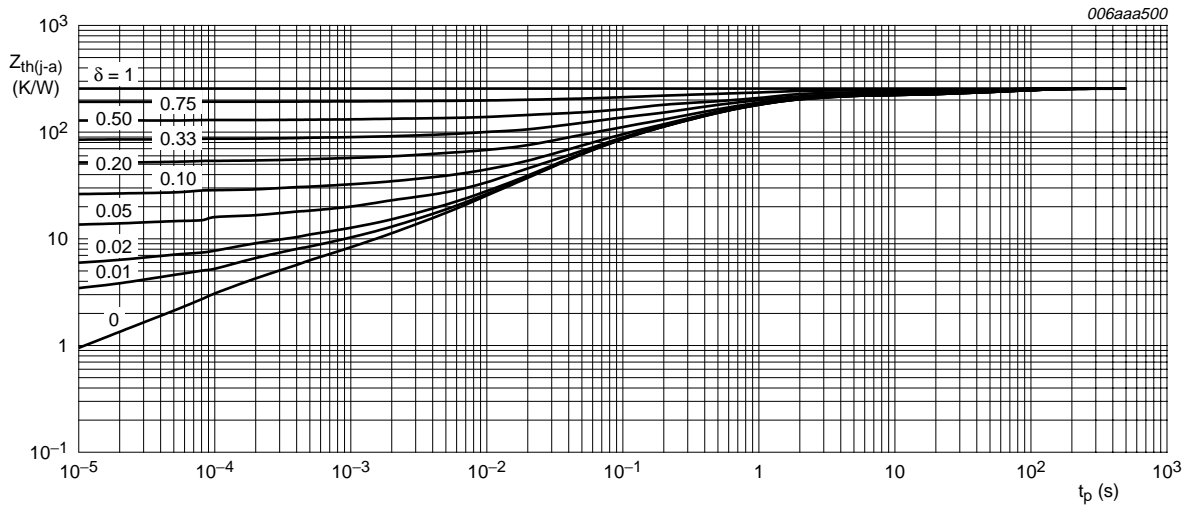
- [1] Device mounted on an FR4 PCB, single-sided copper, tin-plated and standard footprint.
- [2] Device mounted on an FR4 PCB, single-sided copper, tin-plated, mounting pad for collector 1 cm<sup>2</sup>.
- [3] Device mounted on a ceramic PCB, Al<sub>2</sub>O<sub>3</sub>, standard footprint.





FR4 PCB, mounting pad for collector 1 cm<sup>2</sup>

**Fig 3. Transient thermal impedance from junction to ambient as a function of pulse time; typical values**



Ceramic PCB, Al<sub>2</sub>O<sub>3</sub>, standard footprint

**Fig 4. Transient thermal impedance from junction to ambient as a function of pulse time; typical values**

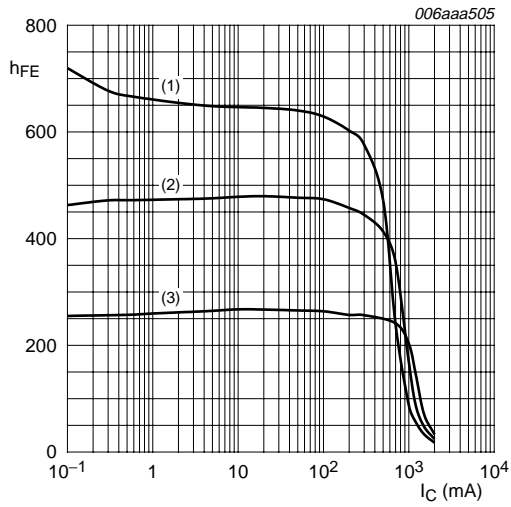
## 7. Characteristics

**Table 7: Characteristics**

$T_{amb} = 25^\circ\text{C}$  unless otherwise specified.

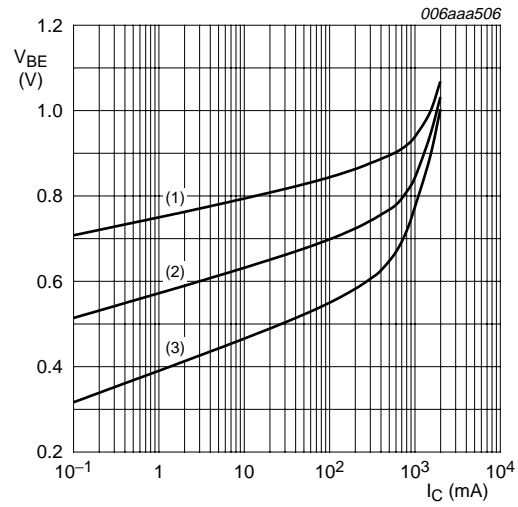
| Symbol      | Parameter                               | Conditions   | Min | Typ  | Max | Unit          |
|-------------|---|--|-----|------|-----|---------------|
| $I_{CBO}$   | collector-base cut-off current          | $V_{CB} = 60\text{ V}; I_E = 0\text{ A}$                               | -   | -    | 100 | nA            |
|             |   | $V_{CB} = 60\text{ V}; I_E = 0\text{ A}; T_j = 150^\circ\text{C}$      | -   | -    | 50  | $\mu\text{A}$ |
| $I_{CES}$   | collector-emitter cut-off current       | $V_{CE} = 60\text{ V}; V_{BE} = 0\text{ V}$                            | -   | -    | 100 | nA            |
| $I_{EBO}$   | emitter-base cut-off current            | $V_{EB} = 5\text{ V}; I_C = 0\text{ A}$                                | -   | -    | 100 | nA            |
| $h_{FE}$    | DC current gain                         | $V_{CE} = 5\text{ V}; I_C = 1\text{ mA}$                               | 250 | 500  | -   |               |
|             |   | $V_{CE} = 5\text{ V}; I_C = 500\text{ mA}$ [1]                         | 200 | 420  | -   |               |
|             |   | $V_{CE} = 5\text{ V}; I_C = 1\text{ A}$ [1]                            | 100 | 180  | -   |               |
| $V_{CEsat}$ | collector-emitter saturation voltage    | $I_C = 100\text{ mA}; I_B = 1\text{ mA}$                               | -   | 90   | 115 | mV            |
|             |   | $I_C = 500\text{ mA}; I_B = 50\text{ mA}$                              | -   | 120  | 150 | mV            |
|             |   | $I_C = 1\text{ A}; I_B = 100\text{ mA}$ [1]                            | -   | 230  | 280 | mV            |
| $R_{CEsat}$ | collector-emitter saturation resistance | $I_C = 1\text{ A}; I_B = 100\text{ mA}$ [1]                            | -   | 230  | 280 | m $\Omega$    |
| $V_{BEsat}$ | base-emitter saturation voltage         | $I_C = 1\text{ A}; I_B = 50\text{ mA}$ [1]                             | -   | 0.95 | 1.1 | V             |
| $V_{BEon}$  | base-emitter turn-on voltage            | $V_{CE} = 5\text{ V}; I_C = 1\text{ A}$ [1]                            | -   | 0.85 | 0.9 | V             |
| $t_d$       | delay time                              | $I_C = 0.5\text{ A}; I_{Bon} = 25\text{ mA}; I_{Boff} = -25\text{ mA}$ | -   | 11   | -   | ns            |
| $t_r$       | rise time                               |  | -   | 78   | -   | ns            |
| $t_{on}$    | turn-on time                            |  | -   | 90   | -   | ns            |
| $t_s$       | storage time                            |  | -   | 340  | -   | ns            |
| $t_f$       | fall time                               |  | -   | 160  | -   | ns            |
| $t_{off}$   | turn-off time                           |  | -   | 500  | -   | ns            |
| $f_T$       | transition frequency                    | $V_{CE} = 10\text{ V}; I_C = 50\text{ mA}; f = 100\text{ MHz}$         | 150 | 220  | -   | MHz           |
| $C_c$       | collector capacitance                   | $V_{CB} = 10\text{ V}; I_E = I_e = 0\text{ A}; f = 1\text{ MHz}$       | -   | 5.5  | 10  | pF            |

[1] Pulse test:  $t_p \leq 300\text{ }\mu\text{s}; \delta \leq 0.02$ .



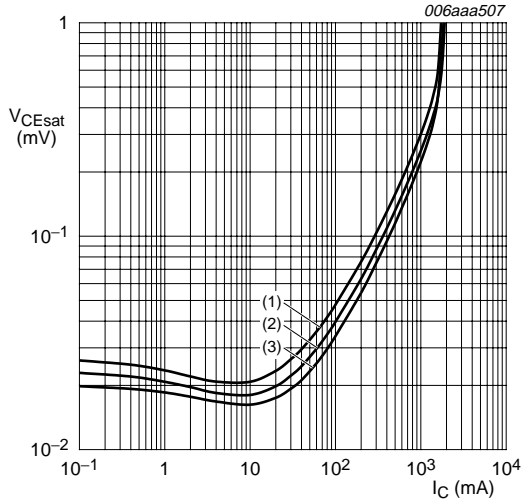
$V_{CE} = 5 V$   
 (1)  $T_{amb} = 100^\circ C$   
 (2)  $T_{amb} = 25^\circ C$   
 (3)  $T_{amb} = -55^\circ C$

**Fig 5. DC current gain as a function of collector current; typical values**



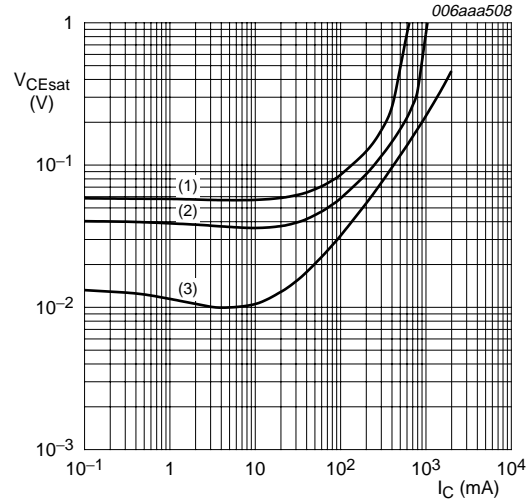
$V_{CE} = 5 V$   
 (1)  $T_{amb} = -55^\circ C$   
 (2)  $T_{amb} = 25^\circ C$   
 (3)  $T_{amb} = 100^\circ C$

**Fig 6. Base-emitter voltage as a function of collector current; typical values**



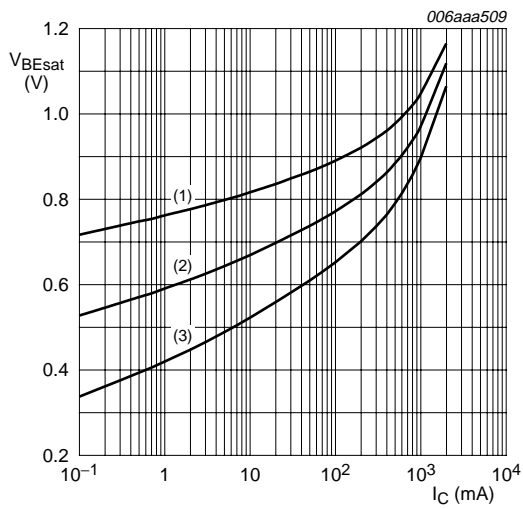
$I_C/I_B = 20$   
 (1)  $T_{amb} = 100^\circ C$   
 (2)  $T_{amb} = 25^\circ C$   
 (3)  $T_{amb} = -55^\circ C$

**Fig 7. Collector-emitter saturation voltage as a function of collector current; typical values**



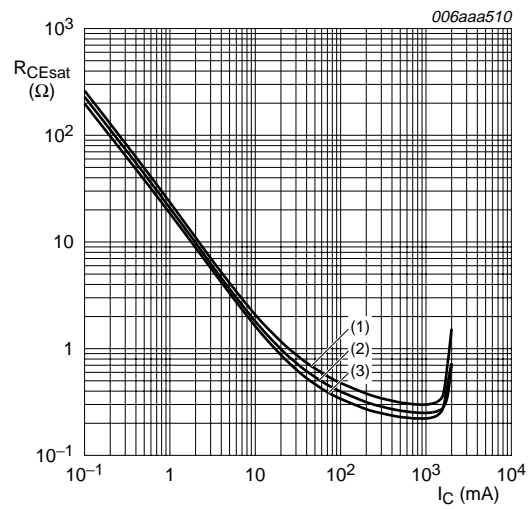
$T_{amb} = 25^\circ C$   
 (1)  $I_C/I_B = 100$   
 (2)  $I_C/I_B = 50$   
 (3)  $I_C/I_B = 10$

**Fig 8. Collector-emitter saturation voltage as a function of collector current; typical values**



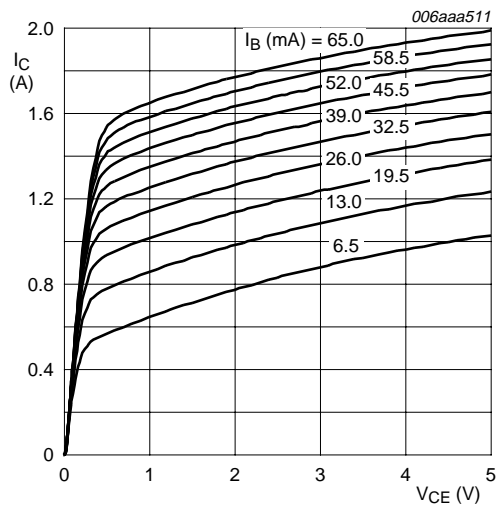
$I_C/I_B = 20$   
 (1)  $T_{amb} = -55\text{ °C}$   
 (2)  $T_{amb} = 25\text{ °C}$   
 (3)  $T_{amb} = 100\text{ °C}$

**Fig 9. Base-emitter saturation voltage as a function of collector current; typical values**



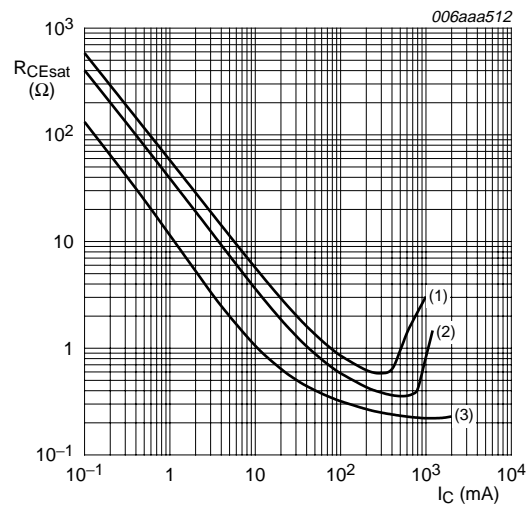
$I_C/I_B = 20$   
 (1)  $T_{amb} = 100\text{ °C}$   
 (2)  $T_{amb} = 25\text{ °C}$   
 (3)  $T_{amb} = -55\text{ °C}$

**Fig 10. Collector-emitter saturation resistance as a function of collector current; typical values**



$T_{amb} = 25\text{ °C}$

**Fig 11. Collector current as a function of collector-emitter voltage; typical values**

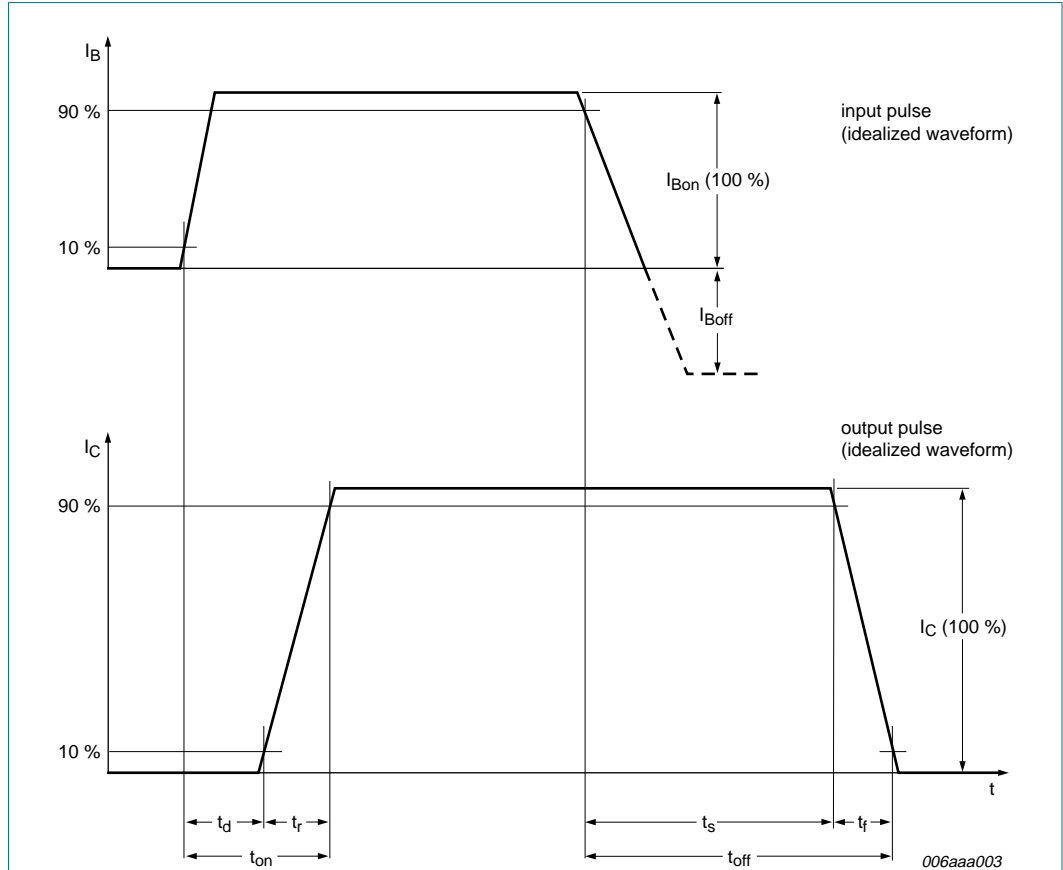


$T_{amb} = 25\text{ °C}$   
 (1)  $I_C/I_B = 100$   
 (2)  $I_C/I_B = 50$   
 (3)  $I_C/I_B = 10$

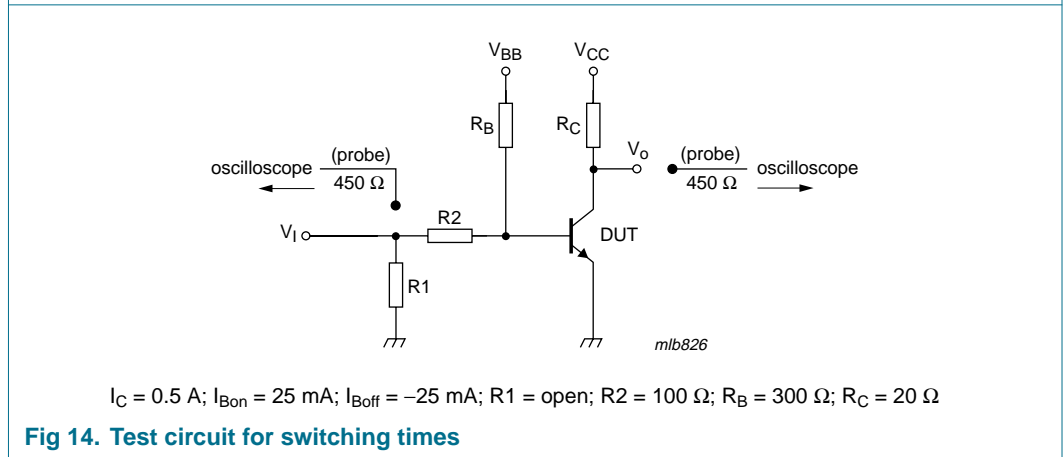
**Fig 12. Collector-emitter saturation resistance as a function of collector current; typical values**



**8. Test information**

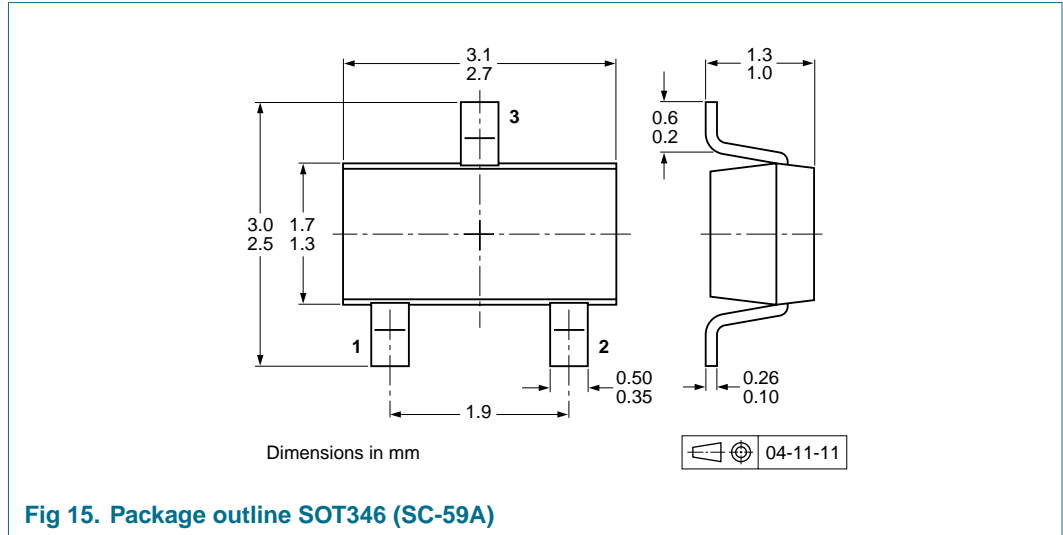


**Fig 13. BISS transistor switching time definition**



**Fig 14. Test circuit for switching times**

## 9. Package outline



## 10. Packing information

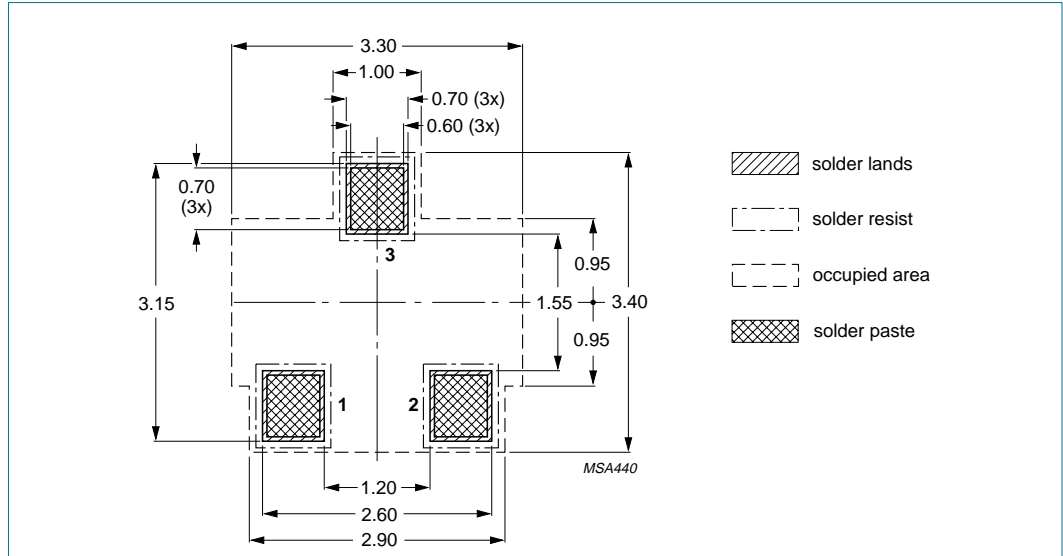
**Table 8: Packing methods**

The indicated -xxx are the last three digits of the 12NC ordering code. [\[1\]](#)

| Type number | Package | Description                    | Packing quantity |       |
|-------------|---------|--------------------------------|------------------|-------|
|             |         |                                | 3000             | 10000 |
| PBSS4160K   | SOT346  | 4 mm pitch, 8 mm tape and reel | -115             | -135  |

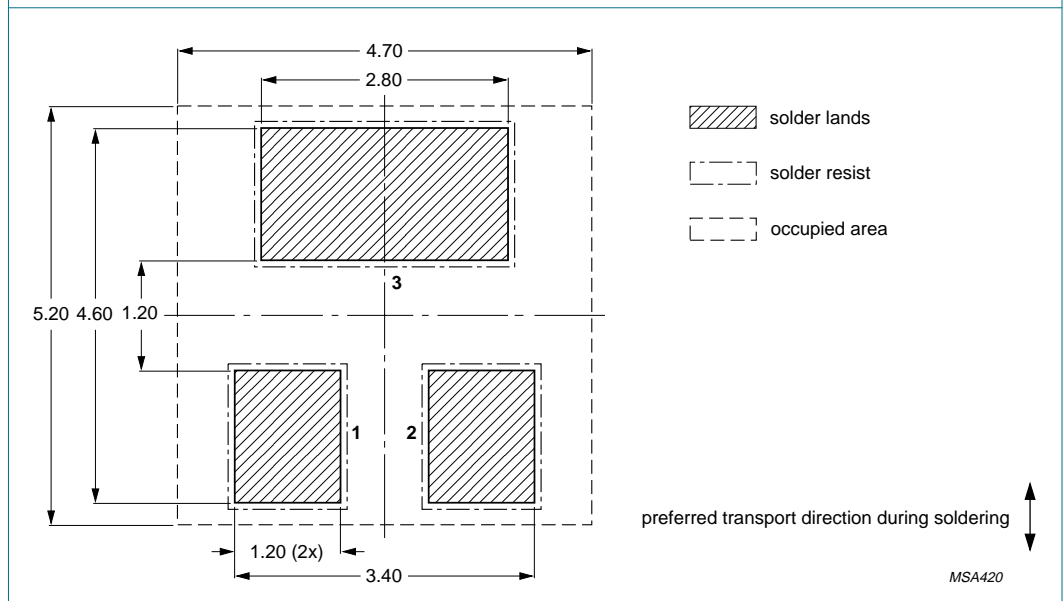
[1] For further information and the availability of packing methods, see [Section 17](#).

**11. Soldering**



Dimensions in mm

**Fig 16. Reflow soldering footprint**



Dimensions in mm

**Fig 17. Wave soldering footprint**

## 12. Revision history

**Table 9: Revision history**

| Document ID    | Release date  | Data sheet status    | Change notice | Doc. number    | Supersedes  |
|----------------|---|----------------------|---------------|----------------|-------------|
| PBSS4160K_2    | 20050718  | Product data sheet   | -             | -              | PBSS4160K_1 |
| Modifications: | <ul style="list-style-type: none"> <li>• Product status changed</li> <li>• <a href="#">Table 7 “Characteristics”</a>: &lt;td&gt; entries superseded by typical and maximum values</li> <li>• <a href="#">Table 7 “Characteristics”</a>: Switching times parameters <math>t_d</math>, <math>t_r</math>, <math>t_{on}</math>, <math>t_s</math>, <math>t_f</math> and <math>t_{off}</math> added</li> <li>• <a href="#">Figure 13 “BISS transistor switching time definition”</a>: added</li> <li>• <a href="#">Figure 14 “Test circuit for switching times”</a>: added</li> <li>• <a href="#">Section 10 “Packing information”</a>: added</li> <li>• <a href="#">Section 11 “Soldering”</a>: added</li> <li>• <a href="#">Section 16 “Trademarks”</a>: added</li> </ul> |                      |               |                |             |
| PBSS4160K_1    | 20040429  | Objective data sheet | -             | 9397 750 12702 | -           |

## 13. Data sheet status

| Level | Data sheet status <sup>[1]</sup> | Product status <sup>[2] [3]</sup> | Definition   |
|-------|----------------------------------|-----------------------------------|--|
| I     | Objective data                   | Development                       | This data sheet contains data from the objective specification for product development. Philips Semiconductors reserves the right to change the specification in any manner without notice.  |
| II    | Preliminary data                 | Qualification                     | This data sheet contains data from the preliminary specification. Supplementary data will be published at a later date. Philips Semiconductors reserves the right to change the specification without notice, in order to improve the design and supply the best possible product.             |
| III   | Product data                     | Production                        | This data sheet contains data from the product specification. Philips Semiconductors reserves the right to make changes at any time in order to improve the design, manufacturing and supply. Relevant changes will be communicated via a Customer Product/Process Change Notification (CPCN). |

[1] Please consult the most recently issued data sheet before initiating or completing a design.

[2] The product status of the device(s) described in this data sheet may have changed since this data sheet was published. The latest information is available on the Internet at URL <http://www.semiconductors.philips.com>.

[3] For data sheets describing multiple type numbers, the highest-level product status determines the data sheet status.

## 14. Definitions

**Short-form specification** — The data in a short-form specification is extracted from a full data sheet with the same type number and title. For detailed information see the relevant data sheet or data handbook.

**Limiting values definition** — Limiting values given are in accordance with the Absolute Maximum Rating System (IEC 60134). Stress above one or more of the limiting values may cause permanent damage to the device. These are stress ratings only and operation of the device at these or at any other conditions above those given in the Characteristics sections of the specification is not implied. Exposure to limiting values for extended periods may affect device reliability.

**Application information** — Applications that are described herein for any of these products are for illustrative purposes only. Philips Semiconductors make no representation or warranty that such applications will be suitable for the specified use without further testing or modification.

customers using or selling these products for use in such applications do so at their own risk and agree to fully indemnify Philips Semiconductors for any damages resulting from such application.

**Right to make changes** — Philips Semiconductors reserves the right to make changes in the products - including circuits, standard cells, and/or software - described or contained herein in order to improve design and/or performance. When the product is in full production (status 'Production'), relevant changes will be communicated via a Customer Product/Process Change Notification (CPCN). Philips Semiconductors assumes no responsibility or liability for the use of any of these products, conveys no license or title under any patent, copyright, or mask work right to these products, and makes no representations or warranties that these products are free from patent, copyright, or mask work right infringement, unless otherwise specified.

## 16. Trademarks

**Notice** — All referenced brands, product names, service names and trademarks are the property of their respective owners.

## 15. Disclaimers

**Life support** — These products are not designed for use in life support appliances, devices, or systems where malfunction of these products can reasonably be expected to result in personal injury. Philips Semiconductors

## 17. Contact information

For additional information, please visit: <http://www.semiconductors.philips.com>

For sales office addresses, send an email to: [sales.addresses@www.semiconductors.philips.com](mailto:sales.addresses@www.semiconductors.philips.com)

## 18. Contents

|           |  |           |
|-----------|--|-----------|
| <b>1</b>  | <b>Product profile</b> . . . . .         | <b>1</b>  |
| 1.1       | General description . . . . .            | 1         |
| 1.2       | Features . . . . .                       | 1         |
| 1.3       | Applications . . . . .                   | 1         |
| 1.4       | Quick reference data . . . . .           | 1         |
| <b>2</b>  | <b>Pinning information</b> . . . . .     | <b>2</b>  |
| <b>3</b>  | <b>Ordering information</b> . . . . .    | <b>2</b>  |
| <b>4</b>  | <b>Marking</b> . . . . .                 | <b>2</b>  |
| <b>5</b>  | <b>Limiting values</b> . . . . .         | <b>3</b>  |
| <b>6</b>  | <b>Thermal characteristics</b> . . . . . | <b>4</b>  |
| <b>7</b>  | <b>Characteristics</b> . . . . .         | <b>6</b>  |
| <b>8</b>  | <b>Test information</b> . . . . .        | <b>9</b>  |
| <b>9</b>  | <b>Package outline</b> . . . . .         | <b>10</b> |
| <b>10</b> | <b>Packing information</b> . . . . .     | <b>10</b> |
| <b>11</b> | <b>Soldering</b> . . . . .               | <b>11</b> |
| <b>12</b> | <b>Revision history</b> . . . . .        | <b>12</b> |
| <b>13</b> | <b>Data sheet status</b> . . . . .       | <b>13</b> |
| <b>14</b> | <b>Definitions</b> . . . . .             | <b>13</b> |
| <b>15</b> | <b>Disclaimers</b> . . . . .             | <b>13</b> |
| <b>16</b> | <b>Trademarks</b> . . . . .              | <b>13</b> |
| <b>17</b> | <b>Contact information</b> . . . . .     | <b>13</b> |



© Koninklijke Philips Electronics N.V. 2005

All rights are reserved. Reproduction in whole or in part is prohibited without the prior written consent of the copyright owner. The information presented in this document does not form part of any quotation or contract, is believed to be accurate and reliable and may be changed without notice. No liability will be accepted by the publisher for any consequence of its use. Publication thereof does not convey nor imply any license under patent- or other industrial or intellectual property rights.

Date of release: 18 July 2005  
Document number: PBSS4160K\_2

Published in The Netherlands