

GlobTek, Inc.
www.globtek.com
186 Veterans Drive,
Northvale, NJ 07647
Tel. (201) 784-1000
Fax (201) 784-0111

Drawing Title: GT-46400-4019-1.0-T2, ITE Power Supply, Efficiency Level: VI, Case Color/Style: GlobTek Black, Desktop/External, Regulated Switchmode AC-DC Power Supply AC Adaptor, Input Rating: 100-240V~, 50-60 Hz, IEC 60320/C8 , Output Rating: 40W, 18V@2.22A, Output Configuration: 1230 mm, 18/1C + Shield Cond, UL 1185, Female Barrel 5.5*2.1*11mm WITH internal Spring Clip and Locking Notch or Equal, Ferrite: Core Size: 14.2*28.5*8.2, GlobTek Black, GT Cord # C4213, Pin Out: Center Positive (+V), Blades/Input Cord: Not Applicable, Approvals: EAC CE SGS (Brazil) 230V CoC Tier 2 NOM CAN ICES-3 China RoHS Double Insulation IP40 Level VI LPS PSE RoHS Ukraine VCCI WEEE cUL CB PSE FCC

Model No. GT-46400-4019-1.0-T2

Part No./Ordering No. TR9KH2222CCP-N(R6B)

Rev B

REVISION HISTORY

REV	DESCRIPTION	SUB	DATE	APPROVED
B	Update packaging Update approval	rchiu	10/30/2017	QA
A	Initial Release	jwarr	05/02/2017	QA

In Addition to GlobTek Inc.'s renewed ISO9001:2008 - Quality Management System Certification, GlobTek Inc. is now certified to:

ISO13485:2003 - Medical Devices Quality Management System Certification

ISO14001:2004 - Environmental Management System Certification

ISO Certificates are available online at <http://www.globtek.com/iso-certificates/>

Customer Approval of Specification:

Please approve, sign and send back to GlobTek so we can complete order processing.

A delay in receipt of this form will delay delivery schedule.

Company Name:

Customer P/N:

Quote Number:

Date:

Authorized Representative Name:

Authorized Representative Signature:

The acceptance of this specification and use of the product described in this document indicates the acceptance and binding of the customer to Globtek terms and conditions, which supersede all other agreements, terms, and conditions (<http://en.globtek.com/terms-and-conditions/>).

Footnote:

GlobTek Inc. will not be liable for the safety and performance of these power supplies if unauthorized access and repair occurs. End user should consult applicable UL, CSA or EN standards for proper installation instruction.

Limitation of Use:

GlobTek product are not authorized for use as mission critical components in life support hazardous environment, nuclear or aircraft applications without prior written approval from the CEO of GlobTek Inc.

Contents of this document are subject to change without prior notice.

GT-46400-4019-1.0-T2, 40W, 18V@2.22A, Desktop/External, Regulated Switchmode AC-DC Power Supply AC Adaptor

PROPRIETARY INFORMATION

PROPRIETARY OF GLOBTEK, INC. ANY REPRODUCTION, DISCLOSURE OR USE OF THIS DRAWING, IN WHOLE OR IN PART, IS HEREBY PROHIBITED EXCEPT AS SPECIFIED IN WRITING BY GLOBTEK, INC.

quest /08/20/2018 7:42:13 AM

GlobTek, Inc.
www.globtek.com
186 Veterans Drive,
Northvale, NJ 07647
Tel. (201) 784-1000
Fax (201) 784-0111

Drawing Title: GT-46400-4019-1.0-T2, ITE Power Supply, Efficiency Level: VI, Case Color/Style: GlobTek Black, Desktop/External, Regulated Switchmode AC-DC Power Supply AC Adaptor, Input Rating: 100-240V~, 50-60 Hz, IEC 60320/C8 , Output Rating: 40W, 18V@2.22A, Output Configuration: 1230 mm, 18/1C + Shield Cond, UL 1185, Female Barrel 5.5*2.1*11mm WITH internal Spring Clip and Locking Notch or Equal, Ferrite: Core Size: 14.2*28.5*8.2, GlobTek Black, GT Cord # C4213, Pin Out: Center Positive (+V), Blades/Input Cord: Not Applicable, Approvals: EAC CE SGS (Brazil) 230V CoC Tier 2 NOM CAN ICES-3 China RoHS Double Insulation IP40 Level VI LPS PSE RoHS Ukraine VCCI WEEE cUL CB PSE FCC

Model No. GT-46400-4019-1.0-T2

Part No./Ordering No. TR9KH222CCP-N(R6B)

Rev B

POWER SUPPLY INFORMATION

TYPE: Desktop/External
TECHNOLOGY: Regulated Switchmode AC-DC Power Supply AC Adaptor
CASE COLOR: GlobTek Black
NAMEPLATE RATED INPUT: 100-240V~, 50-60 Hz, 1.0A
INPUT CONFIG: IEC 60320/C8
WATTS: 40.0
VOLTS OUT: 18
CURRENT OUT (Amps): 2.22
BLADE/CORD INCLUDED: N/A:
BLADE/CORD INSTALLED: N/A:
GROUNDING CONFIGURATION (F1) Class II / Double Insulated
EFFICIENCY LEVEL: VI
OUTPUT CONFIGURATION 1230 mm, 18/1C + Shield Cond, UL 1185, Female Barrel 5.5*2.1*11mm WITH internal Spring Clip and Locking Notch or Equal, Ferrite: Core Size: 14.2*28.5*8.2, GlobTek Black, GT Cord # C4213
CONNECTOR PIN OUT: Center Positive (+V)
LABEL SPECS: Standard GT,L-1186
PACK SPEC: Standard DT, Individually Box

Notes/Modifications/Customizations (notes in this section supersede the values shown in the standard spec):

DIMENSIONS ARE IN MM UNLESS SPECIFIED OTHERWISE.

GlobTek, Inc. www.globtek.com 186 Veterans Drive, Northvale, NJ 07647 Tel. (201) 784-1000 Fax (201) 784-0111	Drawing Title: GT-46400-4019-1.0-T2, ITE Power Supply, Efficiency Level: VI, Case Color/Style: GlobTek Black, Desktop/External, Regulated Switchmode AC-DC Power Supply AC Adaptor, Input Rating: 100-240V~, 50-60 Hz, IEC 60320/C8 , Output Rating: 40W, 18V@2.22A, Output Configuration: 1230 mm, 18/1C + Shield Cond, UL 1185, Female Barrel 5.5*2.1*11mm WITH internal Spring Clip and Locking Notch or Equal, Ferrite: Core Size: 14.2*28.5*8.2, GlobTek Black, GT Cord # C4213, Pin Out: Center Positive (+V), Blades/Input Cord: Not Applicable, Approvals: EAC CE SGS (Brazil) 230V CoC Tier 2 NOM CAN ICES-3 China RoHS Double Insulation IP40 Level VI LPS PSE RoHS Ukraine VCCI WEEE cUL CB PSE FCC	
	Model No. GT-46400-4019-1.0-T2	
	Part No./Ordering No. TR9KH2222CCP-N(R6B)	Rev B

ELECTRICAL SPECIFICATIONS

A) ELECTRICAL SPECIFICATIONS:

01. Input Voltage: Specified 90-264 Vac, Nameplate rated: 100-240Vac
 02. Input Frequency: Specified 47-63 Hz, Nameplate rated 50-60Hz
 03. Inrush Current: NO Damage
 04. Efficiency: Compliant with Efficiency Level VI and CoC Tier 2 standards
 05. No Load Standby Power: <0.075W @ 230Vac
 06. Load regulation: ±5%
 07. Output Voltage: Tolerance ± 5%
 08. Ripple Voltage: 120mV (p-p): Input :(100V-240VAC), Output:full load
- Ripple&Noise test: Use 20MHz band width frequency oscilloscope.Add 0.1uF/47uF Capacitor output connector terminal

B) PROTECTION

01. Over voltage protection: 16V
02. Short circuit protection: Output shut down and auto- recover
03. Over Load Protection: 5A output load

C) SAFETY

01. HI-POT : Input to output : 3000VAC 10mA 1 minute (for Class II), 1500VAC 10mA 1 minute(for Class I)
02. Insulation resistance: Input to output: 500vdc to test the input to output resistance not be less 100M ohm
03. Touch Current: <0.25mA @ 240Vac input voltage

D) OTHER:

01. MTBF: 200,000 Hours @ 25°C ambient temperature
 02. Operating Temperature: 0°C to 40°C ambient temperature
 03. Humidity Operating : 20% to 80%. 0% to 90% relative humidity
 04. Storage Temperature: -10°C to 70°C
- Humidity Storage: 10% to 90%
05. RoHS 2: Complies with EU 2011/65/EU andChina SJ/T 11364-2014

E) ENCLOSURE

01. Housing: High impact plastic, 94V0 polycarbonate, non-vented
02. Size: 111.0 x 52.0 x 32.3 +/-1.0 mm
03. Markings: Label and/or Pad Printed and/or Molded in the case

GlobTek, Inc.
 www.globtek.com
 186 Veterans Drive,
 Northvale, NJ 07647
 Tel. (201) 784-1000
 Fax (201) 784-0111

Drawing Title: GT-46400-4019-1.0-T2, ITE Power Supply, Efficiency Level: VI, Case Color/Style: GlobTek Black, Desktop/External, Regulated Switchmode AC-DC Power Supply AC Adaptor, Input Rating: 100-240V~, 50-60 Hz, IEC 60320/C8 , Output Rating: 40W, 18V@2.22A, Output Configuration: 1230 mm, 18/1C + Shield Cond, UL 1185, Female Barrel 5.5*2.1*11mm WITH internal Spring Clip and Locking Notch or Equal, Ferrite: Core Size: 14.2*28.5*8.2, GlobTek Black, GT Cord # C4213, Pin Out: Center Positive (+V), Blades/Input Cord: Not Applicable, Approvals: EAC CE SGS (Brazil) 230V CoC Tier 2 NOM CAN ICES-3 China RoHS Double Insulation IP40 Level VI LPS PSE RoHS Ukraine VCCI WEEE cUL CB PSE FCC

Model No. GT-46400-4019-1.0-T2

Part No./Ordering No. TR9KH222CCP-N(R6B)

Rev B

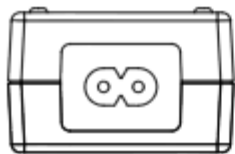
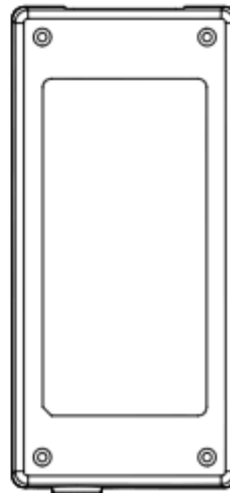
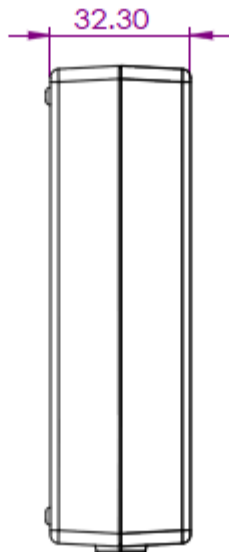
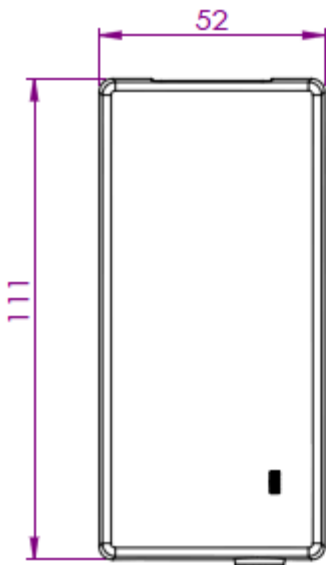
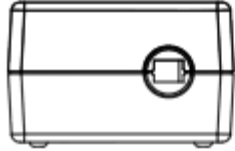

DERATING CURVE

GlobTek, Inc.
 www.globtek.com
 186 Veterans Drive,
 Northvale, NJ 07647
 Tel. (201) 784-1000
 Fax (201) 784-0111

Drawing Title: GT-46400-4019-1.0-T2, ITE Power Supply, Efficiency Level: VI, Case Color/Style: GlobTek Black, Desktop/External, Regulated Switchmode AC-DC Power Supply AC Adaptor, Input Rating: 100-240V~, 50-60 Hz, IEC 60320/C8 , Output Rating: 40W, 18V@2.22A, Output Configuration: 1230 mm, 18/1C + Shield Cond, UL 1185, Female Barrel 5.5*2.1*11mm WITH internal Spring Clip and Locking Notch or Equal, Ferrite: Core Size: 14.2*28.5*8.2, GlobTek Black, GT Cord # C4213, Pin Out: Center Positive (+V), Blades/Input Cord: Not Applicable, Approvals: EAC CE SGS (Brazil) 230V CoC Tier 2 NOM CAN ICES-3 China RoHS Double Insulation IP40 Level VI LPS PSE RoHS Ukraine VCCI WEEE cUL CB PSE FCC

Model No. GT-46400-4019-1.0-T2

Part No./Ordering No. TR9KH2222CCP-N(R6B)

Rev B

Typical External Power Supply Derating Curve

(For Efficiency Level V and Efficiency Level VI Products)

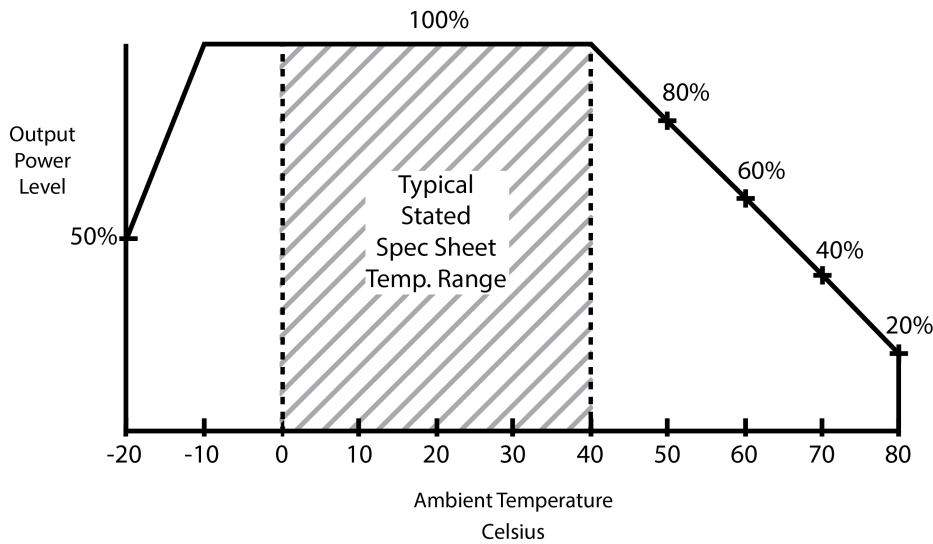

GlobTek, Inc.
 www.globtek.com
 186 Veterans Drive,
 Northvale, NJ 07647
 Tel. (201) 784-1000
 Fax (201) 784-0111

Drawing Title: GT-46400-4019-1.0-T2, ITE Power Supply, Efficiency Level: VI, Case Color/Style: GlobTek Black, Desktop/External, Regulated Switchmode AC-DC Power Supply AC Adaptor, Input Rating: 100-240V~, 50-60 Hz, IEC 60320/C8 , Output Rating: 40W, 18V@2.22A, Output Configuration: 1230 mm, 18/1C + Shield Cond, UL 1185, Female Barrel 5.5*2.1*11mm WITH internal Spring Clip and Locking Notch or Equal, Ferrite: Core Size: 14.2*28.5*8.2, GlobTek Black, GT Cord # C4213, Pin Out: Center Positive (+V), Blades/Input Cord: Not Applicable, Approvals: EAC CE SGS (Brazil) 230V CoC Tier 2 NOM CAN ICES-3 China RoHS Double Insulation IP40 Level VI LPS PSE RoHS Ukraine VCCI WEEE cUL CB PSE FCC

Model No. GT-46400-4019-1.0-T2

Part No./Ordering No. TR9KH2222CCP-N(R6B)

Rev B

INPUT CONFIGURATION

Grounding Configuration:

Blades/Cord Included: N/A:

Blades/Cord Installed: N/A:

IEC 60320/C8 AC Inlet connector, Class II, Non-Earth Ground (aka "Figure-8")

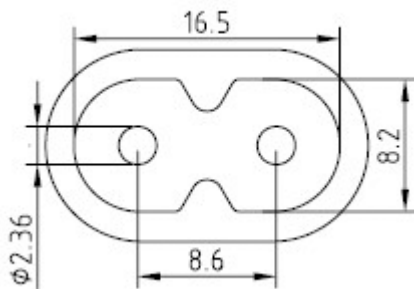

Mates with IEC 60320/C7 Plug

[Standard International IEC 320/C7 Cordsets](#)

Below are standard cordsets which are "not included" (unless stated above); these may be purchased separately or packaged with the power supply. Please contact your Sales Engineer if the style required is not shown below. Many more available in different lengths, colors or cable material.

Conductors (No Ground) IEC 320/C7 (Figure "8")

Part No	Country	End A	End B	Length
4511116F703A(R)	N. American	NEMA 1-15P	IEC 320/C7	1830
5014112M703A(R)	Australian	AS 3112	IEC 320/C7	2000
4533501M8703(R)	China	GB 2099.1	IEC 320/C7	1830
204B4222M703(R)	Brazil	Brazil NBR 6147	IEC 320/C7	2000
2074112M703A(R)	European	CEE 7/16	IEC 320/C7	2000
451J3401M8703(R)	Japan	JIS 8303	IEC 320/C7	1830
2044112M703A(R)	Korea	KS C 8305	IEC 320/C7	2000
4033401M8703A(R)	Taiwan	CNS 10917	IEC 320/C7	1800
6104112M703A(R)	UK	BS1363	IEC 320/C7	2000

GlobTek, Inc.
 www.globtek.com
 186 Veterans Drive,
 Northvale, NJ 07647
 Tel. (201) 784-1000
 Fax (201) 784-0111

Drawing Title: GT-46400-4019-1.0-T2, ITE Power Supply, Efficiency Level: VI, Case Color/Style: GlobTek Black, Desktop/External, Regulated Switchmode AC-DC Power Supply AC Adaptor, Input Rating: 100-240V~, 50-60 Hz, IEC 60320/C8 , Output Rating: 40W, 18V@2.22A, Output Configuration: 1230 mm, 18/1C + Shield Cond, UL 1185, Female Barrel 5.5*2.1*11mm WITH internal Spring Clip and Locking Notch or Equal, Ferrite: Core Size: 14.2*28.5*8.2, GlobTek Black, GT Cord # C4213, Pin Out: Center Positive (+V), Blades/Input Cord: Not Applicable, Approvals: EAC CE SGS (Brazil) 230V CoC Tier 2 NOM CAN ICES-3 China RoHS Double Insulation IP40 Level VI LPS PSE RoHS Ukraine VCCI WEEE cUL CB PSE FCC

Model No. GT-46400-4019-1.0-T2

Part No./Ordering No. TR9KH222CCP-N(R6B)

Rev B

OUTPUT CORD AND CONNECTOR: C1S/C4213

ACTUAL CONNECTORS, OVERMOLDS, FERRITES MAY VARY SLIGHTLY FROM THE PICTURE BELOW

CABLE TYPE	UL 1185
CABLE LENGTH (mm)	1230
CABLE TOLERANCE (mm)	±100
WIRE GAUGE (AWG)	18
CONDUCTORS	1C + Shield
HANK DIMENSION (mm)	95+10, -10
CABLE / CONNECTOR OVERMOLD COLOR	GlobTek Black
FERRITE TYPE / DIMENSION	Core Size: 14.2*28.5*8.2
FERRITE # OF TURNS (Definition)	2 Pass thru core (1 turns)
FERRITE DIMENSION FROM STRAIN RELIEF	50+/-10
FERRITE DIMENSION FROM PLUG	N/A
PLUG TYPE	Female Barrel 5.5*2.1*11mm WITH internal Spring Clip and Locking Notch or Equal
OVER MOLD ORIENTATION	Straight
CONNECTOR PIN OUT:	Center Positive (+V)
ADDITIONAL REQUIREMENTS	

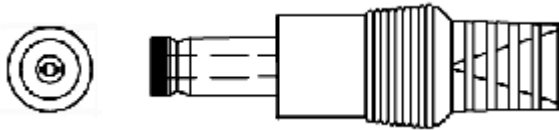

ADDITIONAL OUTPUT PLUG OPTIONS ARE AVAILABLE AT <http://www.globtek.com/connectors/>
 STANDARD PLUGS AND CONNECTORS CAN BE SEEN ONLINE AT <http://www.globtek.com/connectors/>

GlobTek, Inc.
 www.globtek.com
 186 Veterans Drive,
 Northvale, NJ 07647
 Tel. (201) 784-1000
 Fax (201) 784-0111

Drawing Title: GT-46400-4019-1.0-T2, ITE Power Supply, Efficiency Level: VI, Case Color/Style: GlobTek Black, Desktop/External, Regulated Switchmode AC-DC Power Supply AC Adaptor, Input Rating: 100-240V~, 50-60 Hz, IEC 60320/C8, Output Rating: 40W, 18V@2.22A, Output Configuration: 1230 mm, 18/1C + Shield Cond, UL 1185, Female Barrel 5.5*2.1*11mm WITH internal Spring Clip and Locking Notch or Equal, Ferrite: Core Size: 14.2*28.5*8.2, GlobTek Black, GT Cord # C4213, Pin Out: Center Positive (+V), Blades/Input Cord: Not Applicable, Approvals: EAC CE SGS (Brazil) 230V CoC Tier 2 NOM CAN ICES-3 China RoHS Double Insulation IP40 Level VI LPS PSE RoHS Ukraine VCCI WEEE cUL CB PSE FCC

Model No. GT-46400-4019-1.0-T2

Part No./Ordering No. TR9KH2222CCP-N(R6B)

Rev B

LABEL:L-1186

LABEL P/N: Standard GT
 MATERIAL: Flat Thermal Transfer, Imprintable, Polyester Label and/or Pad Printed and/or Molded, and/or Laser Engraved in the case
 BACKGROUND COLOR: Black if housing is Black, White or Silver if housing is White or Gray.
 TEXT COLOR: White or Silver if label is Black Background for Black housing. Black if label is White or Silver background and Housing is White or Gray
 LABEL WIDTH (mm): 37.5
 LABEL HEIGHT (mm): 77.5

Below is the minimum information which will appear on the label. NOTE: in the logo area additional/actual positioning of symbols and text is subjected to change as per agency updates/requirements or additional model approvals become available. Regulatory certifications/label markings may be in logo area on the label or molded into the case housing outside the label area. Information will be shown via label and/or pad printed and/or molded and/or laser engraved in the case. * Date code markings at GlobTek option.



↑
 XXX = USA or CHINA

DATE CODE A *:

DATE CODE LABEL



Series NO. Week Year
 ↑ ↑ ↑
 Class NO. for production

or

DATE CODE B *:

WWYY
 WW = WEEK
 YY = YEAR

A=ITE Power Supply
 B=P/N: (料号) TR9KH2222CCP-N(R6B)
 C=Model (型号) GT-46400-4019-1.0-T2
 D=Input (输入) 100-240V~, 50-60 Hz, 1.0A
 E=Output (输出) 18 V $\overline{\text{---}}$ 2.22 A ,40.0W

- AGENCY ONLINE DOCUMENTS <http://www.globtek.info/certs/GT-46400-WVVV-X.X-TZ/>
- CE EC-Declaration for Medical [Contact GlobTek for more information](#)
- CE EC-Declaration for Industrial/Commercial/ITE http://www.globtek.com/pdf/ec_declaration/a0Oa000000Mih2SEAR
- RoHS/RoHS2 Declaration http://www.globtek.com/pdf/rohs_cert/01ta0000007dRH8AAM
- REACH Declaration http://www.globtek.com/pdf/iso_certificates/REACH.pdf

GlobTek, Inc.
www.globtek.com
186 Veterans Drive,
Northvale, NJ 07647
Tel. (201) 784-1000
Fax (201) 784-0111

Drawing Title: GT-46400-4019-1.0-T2, ITE Power Supply, Efficiency Level: VI, Case Color/Style: GlobTek Black, Desktop/External, Regulated Switchmode AC-DC Power Supply AC Adaptor, Input Rating: 100-240V~, 50-60 Hz, IEC 60320/C8, Output Rating: 40W, 18V@2.22A, Output Configuration: 1230 mm, 18/1C + Shield Cond, UL 1185, Female Barrel 5.5*2.1*11mm WITH internal Spring Clip and Locking Notch or Equal, Ferrite: Core Size: 14.2*28.5*8.2, GlobTek Black, GT Cord # C4213, Pin Out: Center Positive (+V), Blades/Input Cord: Not Applicable, Approvals: EAC CE SGS (Brazil) 230V CoC Tier 2 NOM CAN ICES-3 China RoHS Double Insulation IP40 Level VI LPS PSE RoHS Ukraine VCCI WEEE cUL CB PSE FCC

Model No. GT-46400-4019-1.0-T2

Part No./Ordering No. TR9KH222CCP-N(R6B)

Rev B

Conflict Minerals Declaration

<http://www.globtek.com/pdf/conflict-minerals.pdf>

IPXY rating is based on 3rd party testing and customers should check suitability and test system level IPXY rating before ordering.

Regulatory Certifications/Label Markings

LATEST PRODUCT/MODEL CERTIFICATIONS: <http://en.globtek.com/datasheet/id/a00a000000Mih2S>

AGENCY ONLINE DOCUMENTS: <http://www.globtek.info/certs/GT-46400-WVVV-X.X-TZ/>

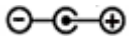

Center Positive (+V)

GlobTek, Inc.
www.globtek.com
186 Veterans Drive,
Northvale, NJ 07647
Tel. (201) 784-1000
Fax (201) 784-0111

Drawing Title: GT-46400-4019-1.0-T2, ITE Power Supply, Efficiency Level: VI, Case Color/Style: GlobTek Black, Desktop/External, Regulated Switchmode AC-DC Power Supply AC Adaptor, Input Rating: 100-240V~, 50-60 Hz, IEC 60320/C8 , Output Rating: 40W, 18V@2.22A, Output Configuration: 1230 mm, 18/1C + Shield Cond, UL 1185, Female Barrel 5.5*2.1*11mm WITH internal Spring Clip and Locking Notch or Equal, Ferrite: Core Size: 14.2*28.5*8.2, GlobTek Black, GT Cord # C4213, Pin Out: Center Positive (+V), Blades/Input Cord: Not Applicable, Approvals: EAC CE SGS (Brazil) 230V CoC Tier 2 NOM CAN ICES-3 China RoHS Double Insulation IP40 Level VI LPS PSE RoHS Ukraine VCCI WEEE cUL CB PSE FCC

Model No. GT-46400-4019-1.0-T2

Part No./Ordering No. TR9KH222CCP-N(R6B)

Rev B

PACKAGING

Packing Spec P/N: Standard DT, Individually
Box

Box Qty: 54

Gift Box Size (mm): 167*58*60

Gift Box Color: White

Master Carton Size (mm): 546*413*217

Master GW (Kg): 9.6 kg

BLADES INCLUDED: N/A:

BLADE/CORD INSTALLED: N/A:

If specific packaging is required, this section must specify all requirements and note "no exceptions". If this section does not specify packaging, it is subject to change without notice at GlobTek's discretion

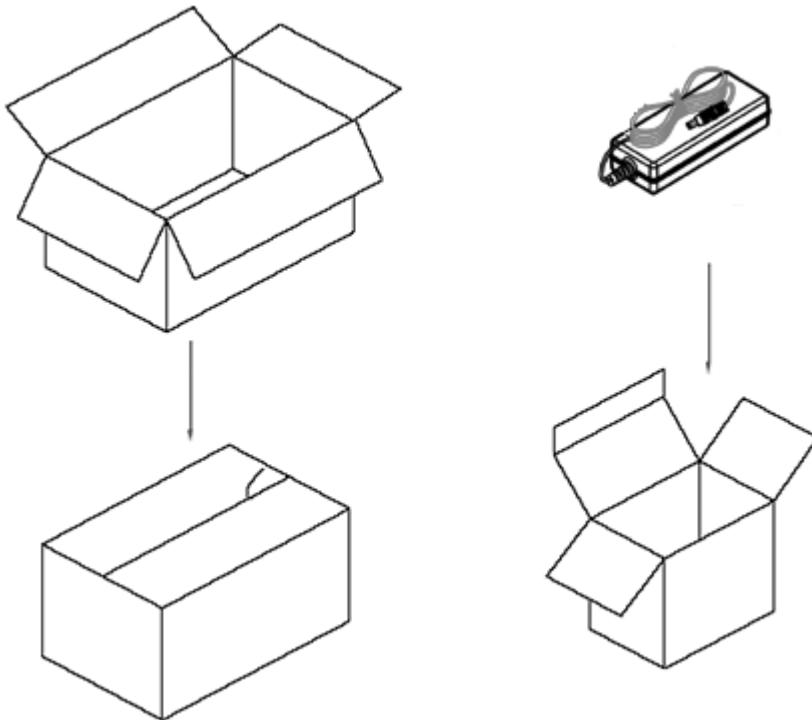

GlobTek, Inc.
www.globtek.com
186 Veterans Drive,
Northvale, NJ 07647
Tel. (201) 784-1000
Fax (201) 784-0111

Drawing Title: GT-46400-4019-1.0-T2, ITE Power Supply, Efficiency Level: VI, Case Color/Style: GlobTek Black, Desktop/External, Regulated Switchmode AC-DC Power Supply AC Adaptor, Input Rating: 100-240V~, 50-60 Hz, IEC 60320/C8, Output Rating: 40W, 18V@2.22A, Output Configuration: 1230 mm, 18/1C + Shield Cond, UL 1185, Female Barrel 5.5*2.1*11mm WITH internal Spring Clip and Locking Notch or Equal, Ferrite: Core Size: 14.2*28.5*8.2, GlobTek Black, GT Cord # C4213, Pin Out: Center Positive (+V), Blades/Input Cord: Not Applicable, Approvals: EAC CE SGS (Brazil) 230V CoC Tier 2 NOM CAN ICES-3 China RoHS Double Insulation IP40 Level VI LPS PSE RoHS Ukraine VCCI WEEE cUL CB PSE FCC

Model No. GT-46400-4019-1.0-T2

Part No./Ordering No. TR9KH222CCP-N(R6B)

Rev B

INSTRUCTION SHEET

N/A