



User Manual

ASMB-923I

**Dual LGA 2011-R3 Intel Xeon®
E5-2600v3 EATX Server Board**

ADVANTECH

Enabling an Intelligent Planet

Copyright

The documentation and the software included with this product are copyrighted 2014 by Advantech Co., Ltd. All rights are reserved. Advantech Co., Ltd. reserves the right to make improvements in the products described in this manual at any time without notice. No part of this manual may be reproduced, copied, translated or transmitted in any form or by any means without the prior written permission of Advantech Co., Ltd. Information provided in this manual is intended to be accurate and reliable. However, Advantech Co., Ltd. assumes no responsibility for its use, nor for any infringements of the rights of third parties, which may result from its use.

Acknowledgements

Intel and Pentium are trademarks of Intel® Corporation.

Microsoft Windows and MS-DOS are registered trademarks of Microsoft® Corp.

All other product names or trademarks are properties of their respective owners.

Product Warranty (2 years)

Advantech warrants to you, the original purchaser, that each of its products will be free from defects in materials and workmanship for two years from the date of purchase.

This warranty does not apply to any products which have been repaired or altered by persons other than repair personnel authorized by Advantech, or which have been subject to misuse, abuse, accident or improper installation. Advantech assumes no liability under the terms of this warranty as a consequence of such events.

Because of Advantech's high quality-control standards and rigorous testing, most of our customers never need to use our repair service. If an Advantech product is defective, it will be repaired or replaced at no charge during the warranty period. For out-of-warranty repairs, you will be billed according to the cost of replacement materials, service time and freight. Please consult your dealer for more details.

If you think you have a defective product, follow these steps:

1. Collect all the information about the problem encountered. (For example, CPU speed, Advantech products used, other hardware and software used, etc.) Note anything abnormal and list any onscreen messages you get when the problem occurs.
2. Call your dealer and describe the problem. Please have your manual, product, and any helpful information readily available.
3. If your product is diagnosed as defective, obtain an RMA (return merchandise authorization) number from your dealer. This allows us to process your return more quickly.
4. Carefully pack the defective product, a fully-completed Repair and Replacement Order Card and a photocopy proof of purchase date (such as your sales receipt) in a shippable container. A product returned without proof of the purchase date is not eligible for warranty service.
5. Write the RMA number visibly on the outside of the package and ship it prepaid to your dealer.

Part No. 2006923101

Printed in Taiwan

Edition 2

October 2015

A Message to the Customer

Advantech Customer Services

Each and every Advantech product is built to the most exacting specifications to ensure reliable performance in the harsh and demanding conditions typical of industrial environments. Whether your new Advantech equipment is destined for the laboratory or the factory floor, you can be assured that your product will provide the reliability and ease of operation for which the name Advantech has come to be known. Your satisfaction is our primary concern. Here is a guide to Advantech's customer services. To ensure you get the full benefit of our services, please follow the instructions below carefully.

Technical Support

We want you to get the maximum performance from your products. So if you run into technical difficulties, we are here to help. For the most frequently asked questions, you can easily find answers in your product documentation. These answers are normally a lot more detailed than the ones we can give over the phone.

So please consult this manual first. If you still cannot find the answer, gather all the information or questions that apply to your problem, and with the product close at hand, call your dealer. Our dealers are well trained and ready to give you the support you need to get the most from your Advantech products. In fact, most problems reported are minor and are easily solved over the phone.

In addition, free technical support is available from Advantech engineers every business day. We are always ready to give advice on application requirements or specific information on the installation and operation of any of our products.

Declaration of Conformity

FCC

This device complies with the requirements in part 15 of the FCC rules:

Operation is subject to the following two conditions:

- This device may not cause harmful interference
- This device must accept any interference received, including interference that may cause undesired operation.

Note: This equipment has been tested and found to comply with the limits for a Class A digital device, pursuant to part 15 of the FCC Rules. These limits are designed to provide reasonable protection against harmful interference when the equipment is operated in a commercial environment. This equipment generates, uses, and can radiate radio frequency energy and, if not installed and used in accordance with the instruction manual, may cause harmful interference to radio communications. Operation of this equipment in a residential area is likely to cause harmful interference in which case the user will be required to correct the interference at his own expense.

Caution! *There is a danger of a new battery exploding if it is incorrectly installed. Do not attempt to recharge, force open, or heat the battery. Replace the battery only with the same or equivalent type recommended by the manufacturer. Discard used batteries according to the manufacturer's instructions.*



Peripheral Compatibility

Category	Advantech PN	Vendor	Part Description	Remarks
MB	ASMB-923I-00A1E	Advantech	Support BMC module	
	ASMB-923-00A1E	Advantech	Basic sku	
CPU		Intel	E5-2600 v3 product family	
SATA HDD			2.5" & 3.5" SATA2 & SATA3 HDD device	
Memory			DDR4 ECC-REG 2133/1866/1600 MHz DIMM	
Cooler/ Heatsink	1960055362N001	AVC	LGA-2011 square CPU cooler for 2U/4U chassis (145 W)	
	1960065684N001	Coolermaster	LGA-2011 square CPU cooler for 4U chassis (160 W)	
Option Card	PCA-AUDIO-HDA1E	Advantech	Audio card	
Riser Card	ASMB-RF348-21A1E	Advantech	ASMB-RF348 (2U riser card)	Only 2*PCIe x8 (x4 link) available
	ASMB-RF3X8-21A1E	Advantech	ASMB-RF3X8 (2U riser card)	Only PCIe x8 slot available

Initial Inspection

Before installing motherboard, please make sure that the following materials have been shipped:

- 1 x ASMB-923I EATX motherboard
- 1 x ASMB-923I Startup Manual
- 1 x Driver CD (user manual is included)
- 2 x Serial ATA HDD data cables
- 1 x I/O port bracket
- 2 x CPU power cable (8P)
- 2 x SATA power cable
- 1 x Warranty card

If any of these items are missing or damaged, contact distributor or sales representative immediately. We have carefully inspected the ASMB-923I mechanically and electrically before shipment. It should be free of marks and scratches and in perfect working order upon receipt. When unpacking the ASMB-923I, check it for signs of shipping damage. (For example, damaged box, scratches, dents, etc.) If it is damaged or it fails to meet the specifications, notify our service department or local sales representative immediately. Also notify the carrier. Retain the shipping carton and packing material for inspection by the carrier. After inspection, we will make arrangements to repair or replace the unit.

Order Information

Part Number	HDD	Expansion Slot	IPMI
ASMB-923I-00A1E	10*SATA3	4 PCIe x16 + 2 PCIe x8 (Gen 3.0) + PCIe x4 (Gen 2.0)	Yes
ASMB-923-00A1E	10*SATA3	4 PCIe x16 + 2 PCIe x8 (Gen 3.0) + PCIe x4 (Gen 2.0)	-

Contents

Chapter 1 Overview 1

1.1	Introduction	2
1.2	Features	2
1.3	Specifications	3
	Table 1.1: Specifications	3
1.4	Board Layout, Jumpers and Connectors.....	5
	Figure 1.1 Board Layout	5
	Figure 1.2 Rear I/O	6
	Table 1.2: Onboard LAN LED Color Definition	6
	Table 1.3: Jumpers	6
	Table 1.4: Connectors	7
	Table 1.5: Onboard LED	8
1.5	Block Diagram	8
	Figure 1.3 Block Diagram	8
1.6	System Memory	9
1.7	Memory Installation Procedures.....	9
1.8	Processor Installation	11

Chapter 2 Connections 15

2.1	Introduction	16
2.2	USB Ports and LAN Ports (USB0~USB10/LAN1/LAN2/IPMI_LAN1)	16
2.3	VGA Connector	17
2.4	Serial Ports (COM1/COM2)	17
2.5	PS2 Keyboard and Mouse Connectors (KBMS1/KBMS2)	18
2.6	CPU Fan Connector (CPU FAN0/FAN1)	18
	Table 2.1: CPU FAN Pin Definition.....	19
2.7	System Fan Connector (SYS FAN0/FAN1/FAN2)	19
	Table 2.2: SYS FAN Pin Definition	19
2.8	Front Panel Connector (JFP1)	20
2.8.1	Power LED (JFP3).....	20
	Table 2.3: ATX Power Supply LED Status	20
2.8.2	External Speaker (JFP2 pins 1, 4, 7, 10).....	20
2.8.3	HDD LED Connector (JFP1 Pins 2 & 5)	21
2.8.4	Reset Connector (JFP1 Pins 9 & 12).....	21
2.8.5	SNMP Connector (JFP1 Pins 8 & 11).....	21
2.8.6	Case Open (JCASE1).....	21
2.9	SATA SGPIO (SATA_SGPIO_1)	22
2.10	Front Panel LAN Indicator Connector (LANLED1).....	23
2.11	Serial ATA Interface (SATA0-SATA5, sSATA0-sSATA3)	24
2.12	PCIe & PCI Expansion Slots	25
2.13	Auxiliary Power Connector (ATXPWR1/ATX12V1/ATX12V2)	26
2.14	HD Audio Interface Connector (AUDIO1)	27
2.15	LPC Connector (LPC1) for Optional TPM Module	28
2.16	Clear CMOS Connector (JCMOS1)	29
2.17	PMBUS Connector (PMBUS1).....	29
2.18	Front Panel SMBUS Connector (SMBUS1).....	30
2.19	IPMI Module Connector (BMC1)	31
2.20	VOLT1 Connector	32
2.21	GPIO Connector.....	33

Chapter 3 AMI BIOS 35

3.1	Introduction	36
3.2	BIOS Setup	37
3.2.1	Main Menu	37
3.2.2	Advanced BIOS Features Setup	38
3.2.3	IntelRCSetup	50
3.2.4	Server Management	64
3.2.5	Security	65
3.2.6	Boot	66
3.2.7	Save & Exit	67
Chapter 4	Chipset Software Installation Utility	69
4.1	Before Beginning	70
4.2	Introduction	70
4.2.1	Main Menu	70
4.3	Windows 7 & 8/ Windows server 2008 & 2012	71
Chapter 5	VGA Setup	73
5.1	Introduction	74
5.2	Windows Series Driver Setup	74
Chapter 6	LAN Configuration & USB 3.0	77
6.1	LAN Configuration	78
6.1.1	Introduction	78
6.1.2	Features	78
6.1.3	Installation	78
6.1.4	Windows Series Driver Setup (LAN)	78
6.2	USB 3.0	79
6.2.1	Introduction	79
6.2.2	Windows Series Driver Setup	79
6.3	AHCI & SATA RAID	80
Appendix A	Programming the Watchdog Timer .	81
A.1	Watchdog Timer Overview	82
A.2	Programming the Watchdog Timer	82
	Table A.1: Watchdog Timer Registers	84
A.2.1	Example Programs	84
Appendix B	I/O Pin Assignments	89
B.1	USB Header (USB67/89)	90
	Table B.1: USB Header (USB67,USB89)	90
B.2	USB3.0 Header(USB2_3)	90
	Table B.2: USB Header (USB23,USB45,USB67,USB89)	90
B.3	VGA Connector (VGA1)	91
	Table B.3: VGA Connector (VGA1)	91
B.4	RS-232 Interface (COM2)	91
	Table B.4: RS-232 Interface (COM2)	91
B.5	PS/2 Keyboard and Mouse Connector (KBMS1)	92
	Table B.5: Keyboard and Mouse Connector (KBMS1)	92
B.6	External Keyboard Connector (KBMS2)	92
	Table B.6: External Keyboard Connector (KBMS2)	92
B.7	System Fan Power Connector (SYSFAN0~2)	93

	Table B.7: Fan Power Connector (SYSFAN0/SYSFAN1/ SYSFAN2).....	93
B.8	Power LED (JFP3).....	93
	Table B.8: Power LED (JFP1).....	93
B.9	External Speaker Connector (JFP2).....	93
	Table B.9: External Speaker Connector (JFP2).....	93
B.10	Reset Connector (JFP1).....	94
	Table B.10:Reset Connector (JFP1).....	94
B.11	HDD LED Connector (JFP1).....	94
	Table B.11:HDD LED Connector (JFP1).....	94
B.12	ATX Soft Power Switch (JFP1).....	94
	Table B.12:ATX Soft Power Switch (JFP1).....	94
B.13	Front panel SMBus Connector (SMBUS1).....	95
B.14	USB/LAN Ports (LAN1_USB01 and LAN2_USB23).....	95
	Table B.13:USB Port.....	95
	Table B.14:Giga LAN 10/100/1000 Base-T RJ-45 Port.....	95
B.15	Audio Connector (AUDIO1).....	96
	Table B.15:Front Panel Audio Connector (FPAUD1).....	96
B.16	8-pin Alarm Board Connector (VOLT1).....	96
	Table B.16:8-pin Alarm Board Connector (VOLT1).....	96
B.17	Case Open Connector (JCASE1).....	96
	Table B.17:Case Open Connector (JFP1).....	96
B.18	Front Panel LAN LED Connector (LANLED1).....	97
	Table B.18:LAN LED Connector (LANLED1).....	97

Chapter 1

Overview

1.1 Introduction

The ASMB-923I serverboard is the most advanced Intel Xeon E5-2600 (V3) series board for server-grade IPC applications that require high-performance computing power & multi-expansion slots. This serverboard supports Intel Xeon E5-2600 (V3) series processor and DDR4 2133/1866/1600 MHz memory up to 256 GB.

ASMB-923I provides four PCIe x16 slots (Gen3) + two PCIe x8 slots (Gen3.0) and one PCIe x4 (Gen2.0).

In addition, the ASMB-923I has dual Gigabit Ethernet LAN ports via a dedicated PCIe x1 bus, which offer bandwidth up to 500 MB/s, eliminating network bottlenecks.

The ASMB-923I has a third RJ-45 LAN connector which is dedicated for IPMI function allowing remote control

High reliability and outstanding performance makes ASMB-923I the ideal platform for industrial server/networking applications.

By using the Intel C612 chipset, the ASMB-923I offers a variety of features such as 10 onboard SATA III interfaces; it supports IRST (Intel Rapid Storage Technology) and provides RAID 0, 1, 10 and 5 (Windows only*); and it has 7 USB 2.0 & 4 USB 3.0 connectors.

These powerful I/O capabilities ensure even more reliable data storage capabilities and high-speed I/O peripheral connectivity.

Note!



1. *IPMI module will be included in ASMB-923I sku.*
2. *Seven USB 2.0 ports (1*Type- A) and four USB 3.0 ports (2 ports from on-board 20-pin header)*
3. *Please refer to the release note of each Linux OS for Intel's C612 chipset SATA RAID function support.*

1.2 Features

General

- **Intel E5-2600 (v3) processor support:** ASMB-923I supports two Intel E5-2600 (v3) series Quad/Six/Eight/Ten core processors.
- **High performance I/O capability:** Dual Gigabit LAN, 4 x PCIe x16 slot (x16 link) + 2 x PCIe x16 slot (x8 link) + 1x PCIe x8 slot (x4 link), 19 x SATA connectors and 7 x 2.0 ports, 4 x USB 3.0.
- **Standard EATX form factor with industrial features:** ASMB-923I provides industrial features like long product lifecycle, reliable operation under wide temperature range, watchdog timer, etc.
- **IPMI 2.0 support:** ASMB-923I equipped with ASPEED 2400 BMC chip supports IPMI 2.0 (Intelligent Platform Management Interface 2.0) via dedicated LAN port.
- **KVM over IP:** ASMB-923I KVM over IP function allows remote control of system through your own computer.

1.3 Specifications

Table 1.1: Specifications

Processor	
CPU	<ul style="list-style-type: none"> ■ Dual Intel LGA2011 Xeon processor sockets ■ Supports Intel Xeon E5-2600 (v3) series processor with Quad/Six/Eight/Ten cores ■ Supports the TDP of processor up to 160 W
System Memory	
Memory Capacity	<ul style="list-style-type: none"> ■ Xeon processor supports DDR4 memory bus ■ Total 8 memory slots provided ■ Supports up to 256 GB memory ■ 4 channels per processor, 1 memory slot per channel
Memory Type	Supports DDR4 2133/1866/1600/1333 MHz ECC-REG Modules
DIMM Sizes	Each memory slot supports 1GB, 2GB, 4GB, 8GB, 16GB and 32GB memory modules
Memory Voltage	1.2 V
Error Detection	<ul style="list-style-type: none"> ■ Corrects single-bit errors ■ Detects double-bit errors (using ECC memory)
On-Board Devices	
Chipsets	Intel C612 PCH provide 8xPCIe Gen2 lanes
Network Controllers	<ul style="list-style-type: none"> ■ 2 x Intel I210 Gigabit Ethernet Controller connected to C612 through PCIe Gen2 Lane. ■ Above network Supports 10BASE-T, 100BASE-TX, and 1000BASE-T, with RJ-45 output.
VGA	ASPEED AST2400/1400 controller with 64 MB VGA memory provides basic 2D VGA function.
Super I/O	Nuvoton NCT6776D chip provide motherboard keyboard mouse, RS-232, parallel port and hardware monitor functions.
BMC (923I SKU Only)	1 x 10/100BASE RealTek 8201EL-VB PHY connected to AST2400 for dedicated IPMI/IKVM.
Input / Output	
Serial ATA	<ul style="list-style-type: none"> ■ Total 10 x SATA ports and provide 6 Gb/s bandwidth. ■ RAID 0, 1, 5, 10 support (Windows only. For Linux support please refer to the note item 4 of chapter 1.1).
LAN	<ul style="list-style-type: none"> ■ 2 x RJ-45 LAN ports (10/100/1000 Base-T LAN). ■ 1 x RJ-45 Dedicated IPMI LAN port(10/100 Base-T) for IPMI only, there is no regular LAN function (ASMB-923I SKU Only).
USB	<ul style="list-style-type: none"> ■ 2 x USB3.0 + 2 x USB 2.0 ports at rear window. ■ 2 x USB 2.0 internal headers (4 ports). ■ 1 x USB 3.0 internal header (2 ports). ■ 1 x internal Type-A USB port.
VGA	<ul style="list-style-type: none"> ■ 1 x VGA port.
Keyboard / Mouse	<ul style="list-style-type: none"> ■ PS/2 keyboard and mouse connector at rear window.
Serial Port / Header	<ul style="list-style-type: none"> ■ 1 x internal header (2 x 5 2.5 mm pitch) for UART port. ■ 1 x external DB9 UART at rear window.

Table 1.1: Specifications**Power Connector**

System Power	1 x 24-pin SSI EPS 12 V power connector (Input 12 V, 5 V, 3.3 V, 5 V standby)
CPU Power	2 x 8 pin SSI EPS 12 V power connector for CPU & Memory power (12V)
PCIe slot power	1 x 8pin 12 V power connector for PCIe slot 12 V input

Expansion Slots

PCI-express	<ul style="list-style-type: none"> ■ 4 x PCI-E x16 slot (Gen3 x16 link) <ul style="list-style-type: none"> – PCIEX16_SLOT1 (from CPU 1) – PCIEX16_SLOT3 (from CPU 1) – PCIEX16_SLOT5 (from CPU 0) – PCIEX16_SLOT7 (from CPU 0) ■ 1 x PCI-E x16 slot (Gen3 x8 link) <ul style="list-style-type: none"> – PCIEX16_SLOT2 (from CPU 1) – PCIEX16_SLOT6 (from CPU 0) ■ 1 x PCI-E x8 slot (Gen2 x4 link) <ul style="list-style-type: none"> – PCIEX8_SLOT4 (from PCH)
-------------	--

System BIOS

BIOS Type	128 Mb SPI Flash EEPROM with AMI BIOS
-----------	---------------------------------------

PC Health Monitoring

Voltage	Monitors for CPU Cores, +3.3 V, +5 V, +12 V, +5 V Standby, VBAT
Fan	<ul style="list-style-type: none"> ■ Two 4-pin heads for CPU cooler and three 4-pin headers for system fan. ■ All fans with tachometer status monitoring ■ Thermal control for all fan connectors
Temperature	<ul style="list-style-type: none"> ■ Monitoring for CPU (PECI) ■ Monitoring for System (SIO)
Other Features (Case Open)	<ul style="list-style-type: none"> ■ Chassis intrusion detection ■ Chassis Intrusion header

Operating Environment / Compliance

RoHS	RoHS Compliant 6/6 Pb Free
Environmental Spec.	<ul style="list-style-type: none"> ■ Operating Temperature: 0 to 40° C ■ Non-operating Temperature: -40 to 85° C ■ Operating Relative Humidity: 10% to 90% (non-condensing) ■ Non-operating Relative Humidity: 10% to 95% (non-condensing)

1.4 Board Layout, Jumpers and Connectors

Connectors on the ASMB-923I are linked to external devices such as hard disk drives. In addition, ASMB-923I has a number of jumpers that are used to configure the system for specific applications.

The tables below list the functions of each jumper and connector. Later sections in this chapter give instructions for setting jumpers. Chapter 2 gives instructions for connecting external devices to ASMB-923I.

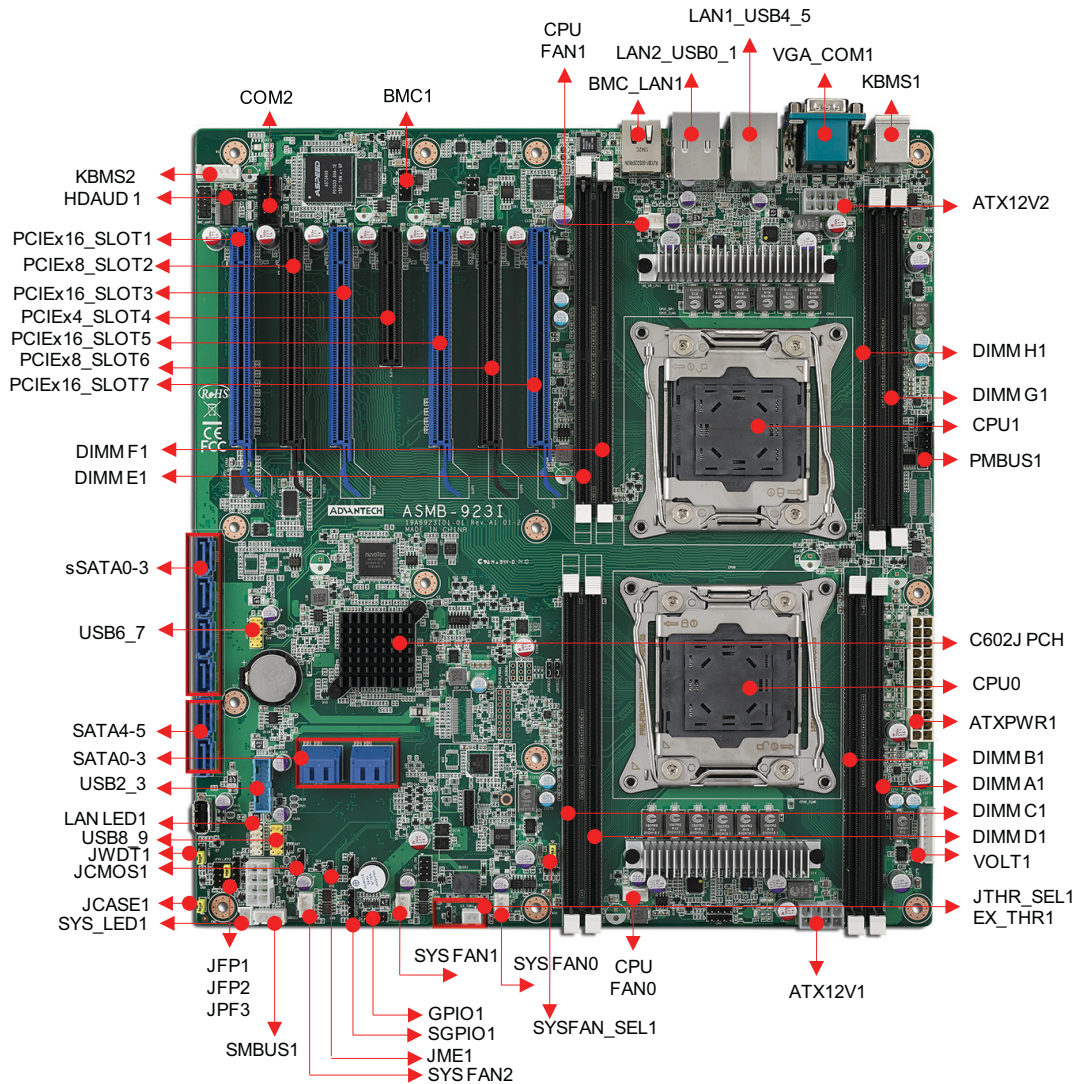

Figure 1.1 Board Layout

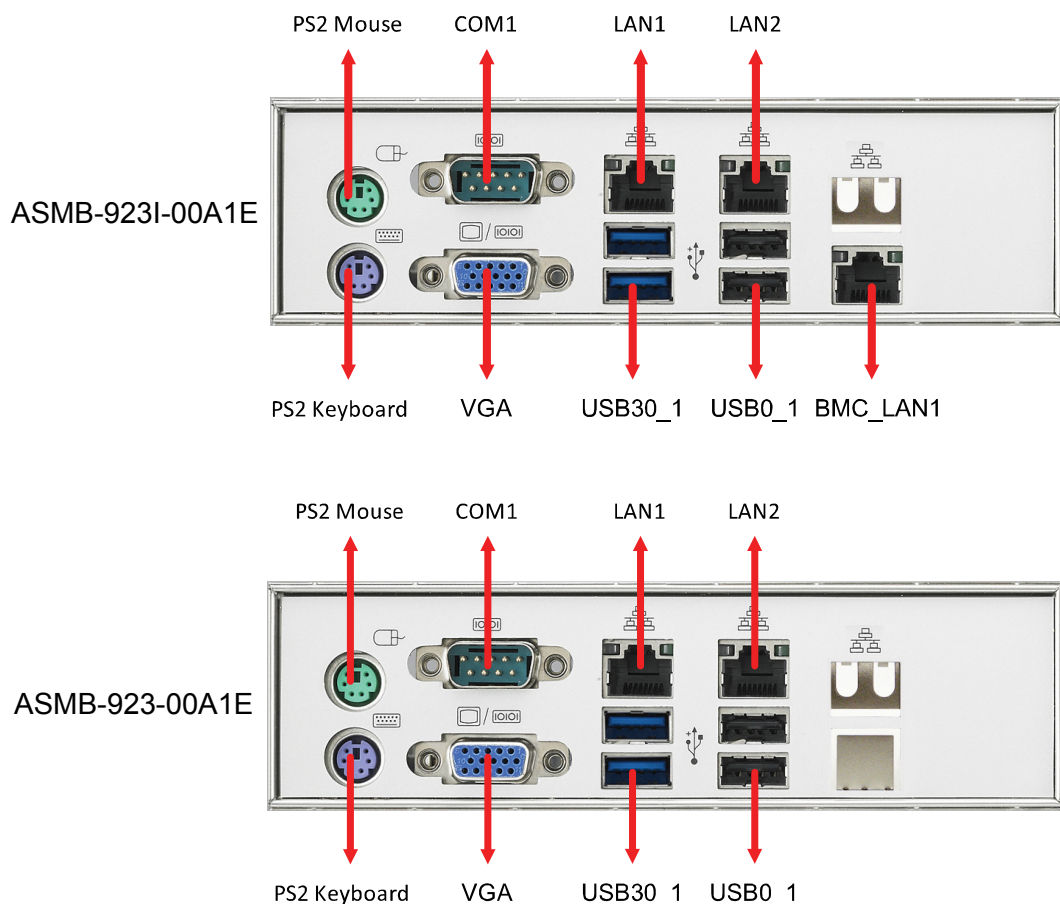

Figure 1.2 Rear I/O

Table 1.2: Onboard LAN LED Color Definition

10/100/1000 Mbps LAN Link/Activity LED Scheme

		LAN1 & LAN2		BMC LAN1	
		Left LED	Right LED	Left LED	Right LED
10 Mbps	Link	Off	Green	Amber	-
	Active	Off	Blinking green	Amber	Blinking green
100 Mbps	Link	Amber	Green	Amber	-
	Active	Amber	Blinking green	Amber	Blinking green
1000 Mbps	Link	Green	Green	-	-
	Active	Green	Blinking green	-	-
No Link		Off	Off	Off	Off

Table 1.3: Jumpers

Label	Function	Default
JCMOS1	CMOS Clear	1-2
JME1	ME update	1-2

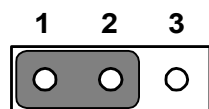

Keep CMOS data/
Disable ME update/

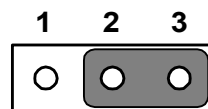

Clear CMOS data/
Enable ME update/

Table 1.4: Connectors

Label	Function
ATX12V1	SSI EPS 12 V auxiliary power connector (for CPU0) and memory
ATX12V2	SSI EPS 12 V auxiliary power connector (for CPU1) and memory
ATXPWR1	SSI EPS 24-pin main power connector (for system)
SLOT12V1	For PCIe slot 12 V input only
COM2	Serial port: RS-232
CPU0	Intel LGA2011 CPU0 socket
CPU1	Intel LGA2011 CPU1 socket
CPUFAN0	CPU0 fan connector (4-pin)
CPUFAN1	CPU1 fan connector (4-pin)
DIMMA1	Channel A DIMM1 of CPU0
DIMMB1	Channel B DIMM1 of CPU0
DIMMC1	Channel C DIMM1 of CPU0
DIMMD1	Channel D DIMM1 of CPU0
DIMME1	Channel E DIMM1 of CPU1
DIMMF1	Channel F DIMM1 of CPU1
DIMMG1	Channel G DIMM1 of CPU1
DIMMH1	Channel H DIMM1 of CPU1
JFP1/JFP2/JFP3	Front panel pin header connector
AUDIO1	HD audio Interface connector
BMC1	IPMI connector
LANLED1	LAN1 & LAN2 LED extension connector
LPC1	LPC port for debug & TPM module
SLOT1	PCIE x16 slot
SLOT2	PCIE x16 slot (x8 link)
SLOT3	PCIE x16 slot
SLOT4	PCIE x16 slot (x4 link)
SLOT5	PCIE x16 slot
SLOT6	PCIE x16 slot (x8 link)
SLOT7	PCIE x16 slot
SYS FAN0	System fan connector (4-pin)
SYS FAN1	System fan connector (4-pin)
SYS FAN2	System fan connector (4-pin)
USB0_1, USB2_3	USB 3.0 port 0, 1; USB 3.0 port 2, 3 (20pin header)
USB45	USB port 4, 5
USB67	USB port 6, 7
USB89	USB port 8, 9
USB10	USB port 10 (Type-A)
VOLT1	For Advantech alarm board usage

Table 1.4: Connectors

PMBUS1	Power supply SMBus I2C Header
SATA_SGPIO_1	Supports Serial_Link interface for onboard SATA connections
GPIO1	GPIO function for customize usage
SMBUS1	For Advantech chassis usage
KBMS2	For additional keyboard/mouse
JWDT1	Enable (Default pin 1-2)/disable watch dog function
SYSFAN_SEL1	FAN PWM (Default pin 1-2)/DC mode
JTHER_SEL1	Thermistor choose for internal (Default pin 1-2)/external
EX_THR1	For external thermistor cable use
SYS_LED1	For optional system LED indicator

Table 1.5: Onboard LED

LED	Description	LED Definition
5V_LED1	Power on LED	Off: Power off On (Green): System is On
5VSB_LED1	Standby LED	Off: No input AC Power On (Green): System is ON, in sleep mode, or in soft-off mode
LED3	BMC heartbeat LED (ASMB-923I SKU Only)	Blinking (Green): Controller is working normally

1.5 Block Diagram

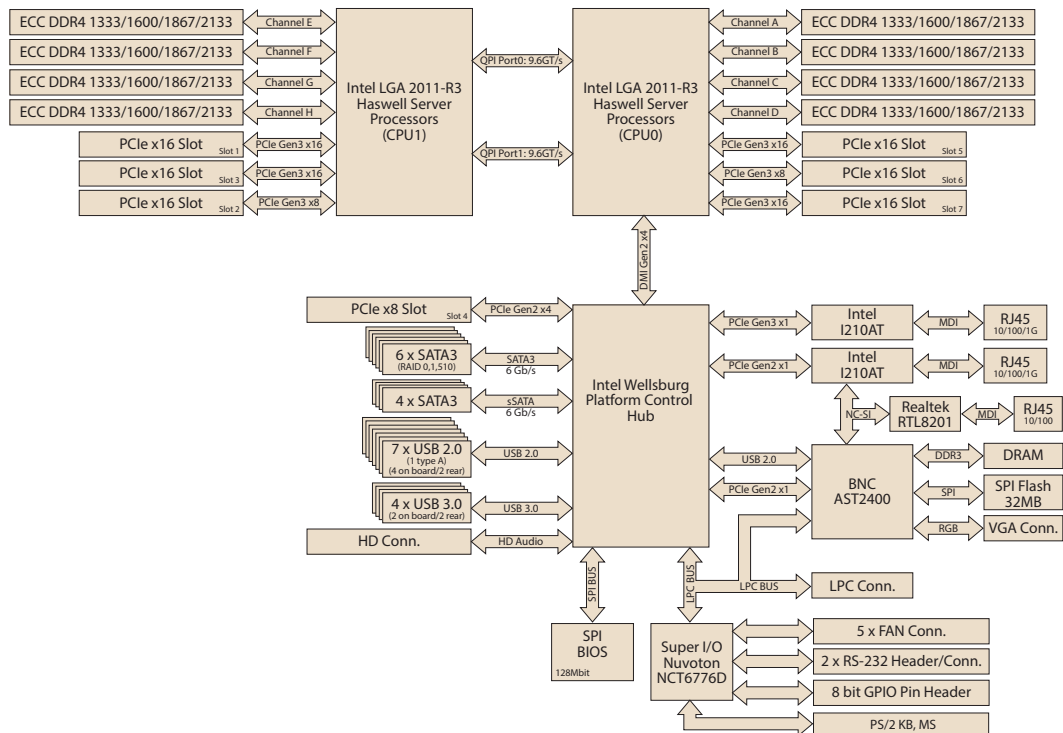

Figure 1.3 Block Diagram

1.6 System Memory

ASMB-923I has eight 288-pin memory slots for DDR4 1600/1866/2133 MHz memory modules with maximum capacity of 256 GB (Maximum 32 GB for each DIMM). ASMB-923I supports registered DIMMs memory module.

1.7 Memory Installation Procedures

	Single CPU Installed (CPU0)				Dual CPU Installed (CPU0 & CPU1)								Quantity of memory installed
	1	2	3	4	2	3	4	5	6	7	8		
DIMM A1	✓	✓	✓	✓	✓	✓	✓	✓	✓	✓	✓	✓	
AIMM B1		✓	✓	✓		✓	✓	✓	✓	✓	✓	✓	
DIMM C1			✓	✓				✓	✓	✓	✓	✓	
DIMM D1				✓						✓	✓	✓	
DIMM E1					✓	✓	✓	✓	✓	✓	✓	✓	
DIMM F1							✓	✓	✓	✓	✓	✓	
DIMM G1									✓	✓	✓	✓	
DIMM H1											✓	✓	

Step 1

To install DIMMs, first make sure the two handles of the DIMM socket are in the “open” position. i.e. The handles lean outward.

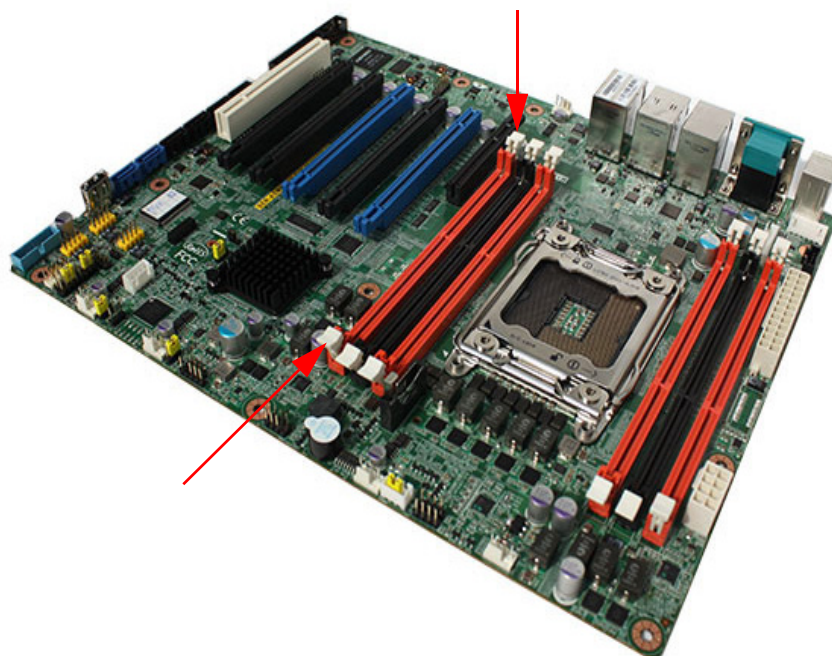

Step 2

Slowly slide the DIMM module along the plastic guides on both ends of the socket,

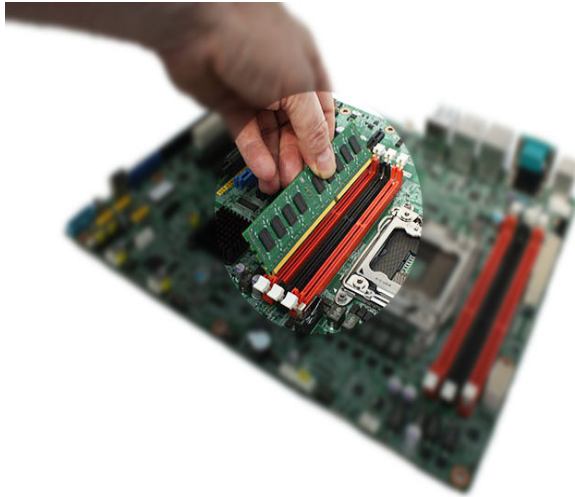
**Step 3**

Press the DIMM module right down into the socket, until you hear a click. This is when the two handles have automatically locked the memory module into the correct position of the DIMM socket.

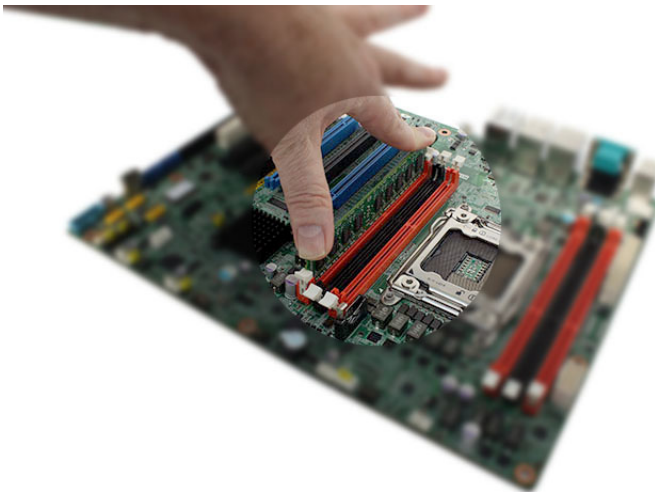
**Step 4**

Finished.

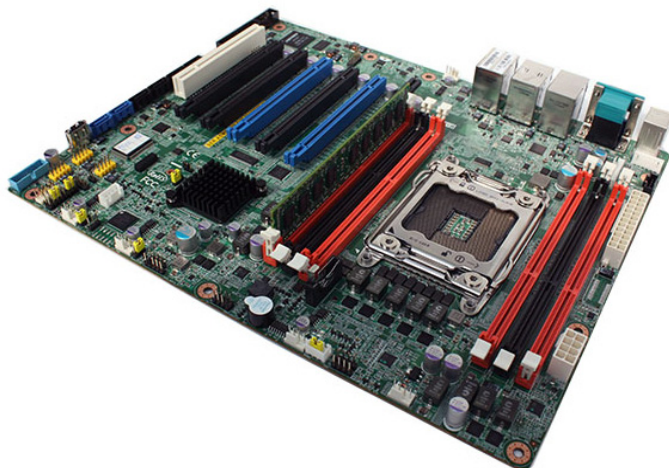

1.8 Processor Installation

The ASMB-923I is designed for Intel E5-2600 v3 series Xeon processor.

Step 1

Press the first lever and move it sideways slightly until it is released from the retention tab.

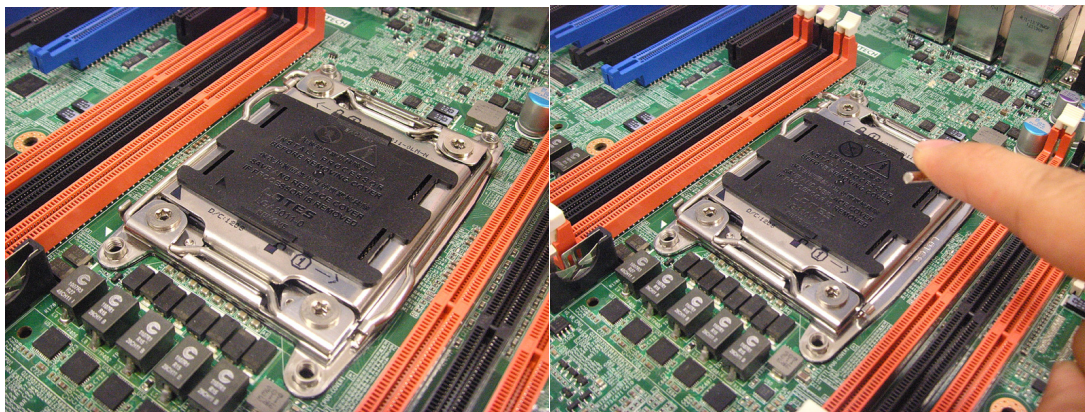

Step 2

Press the other lever and move it sideways slightly until it is also released from the retention tab.

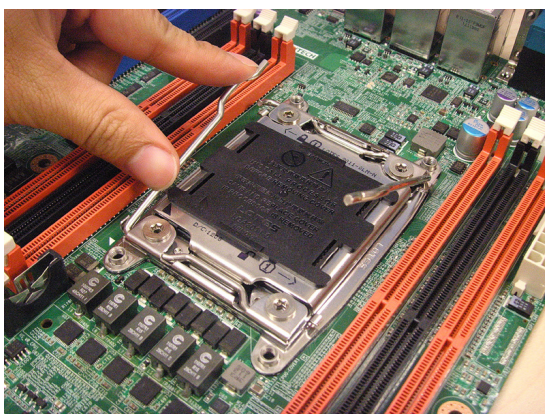

Step 3

Lift the load plate.

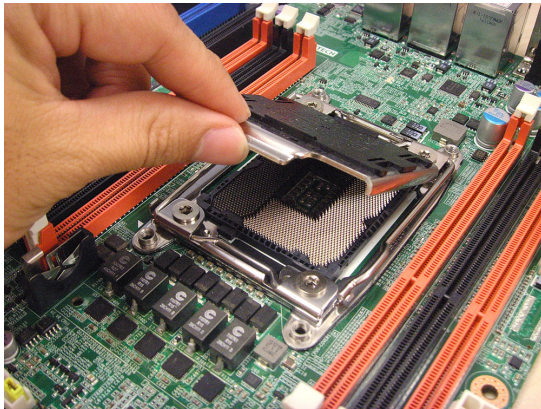

Step 4

Position the CPU over the socket ensuring that the triangle mark on the CPU lines up with the triangle mark on the motherboard.

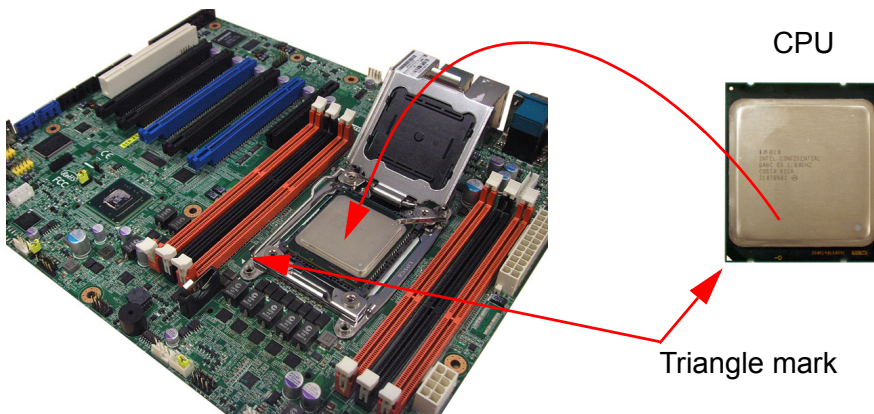

Step 5

Remove protective plastic cover.

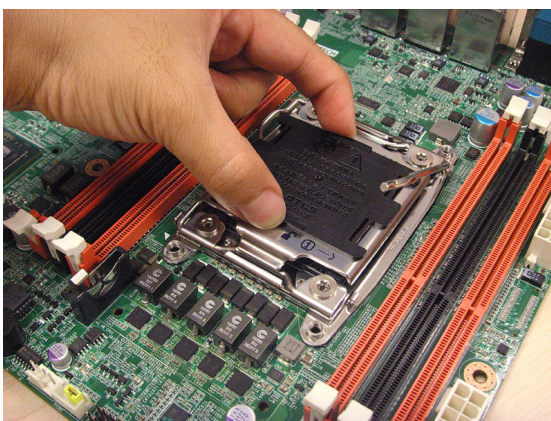

Step 6

Close the load plate over the CPU.

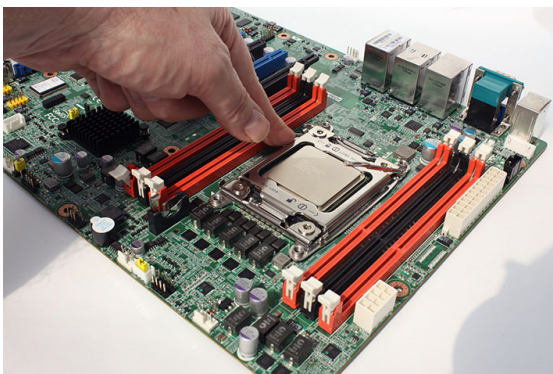
**Step 7**

Push down both levers and insert them under the retention tabs ensuring the edge of the load plate is fixed securely by both levers.

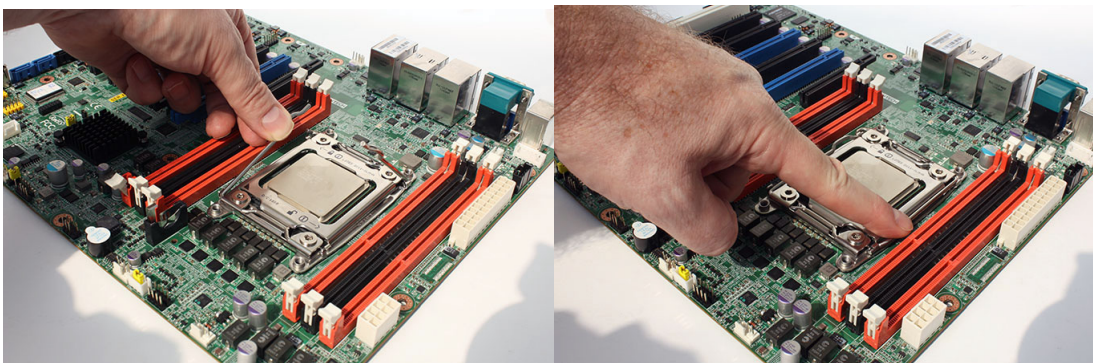
**Step 8**

Finished.



Chapter 2

Connections

2.1 Introduction

You can access most of the connectors from the top of the board as it is being installed in the chassis. If you have a number of cards installed, you may need to partially remove a card to make all the connections.

2.2 USB Ports and LAN Ports (USB0~USB10/LAN1/LAN2/IPMI_LAN1)

The USB ports comply with USB 2.0 & 3.0. Transmission rates could be up to 480 Mbps (USB 2.0) / 5Gbps (USB 3.0) and fuse protection are supported. The USB interface can be disabled in the system BIOS setup.

The ASMB-923I is equipped with two high-performance 1000 Mbps Ethernet LANs. They are supported by all major network operating systems. The RJ-45 jacks on the rear plate provide convenient 1000Base-T operation.

ASMB-923I is also equipped with the additional 100 Mbps Ethernet LAN (BMC_LAN1 Port) which is shared with IPMI for system management.

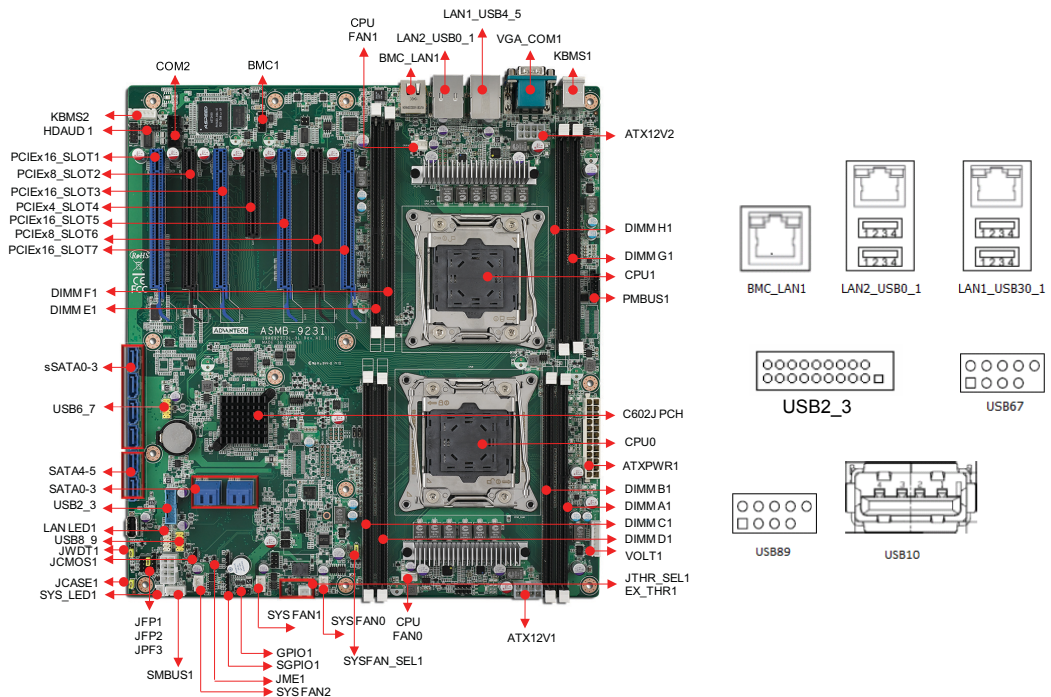

Example: USB45 (pin definitions are the same as USB67 & USB89)

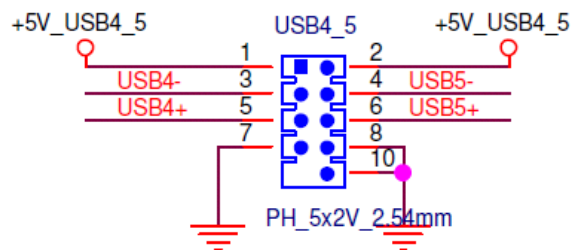

2.3 VGA Connector

The ASMB-923I includes a VGA interface that can drive conventional CRT and LCD displays.

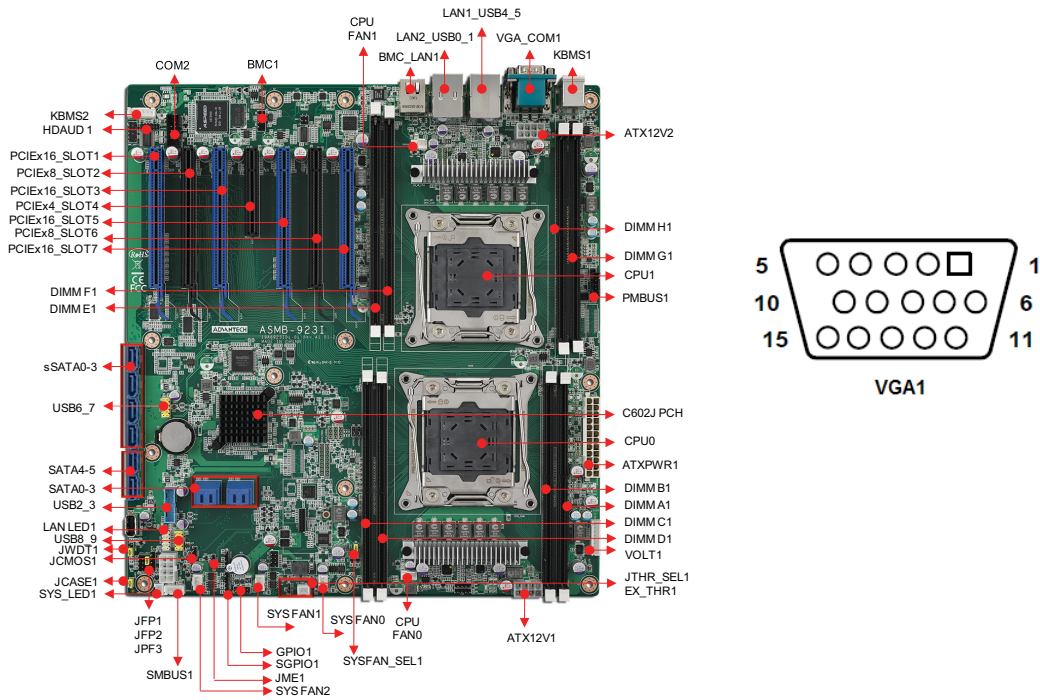

2.4 Serial Ports (COM1/COM2)

The ASMB-923I offers 2 serial ports (One on the rear panel and one onboard).

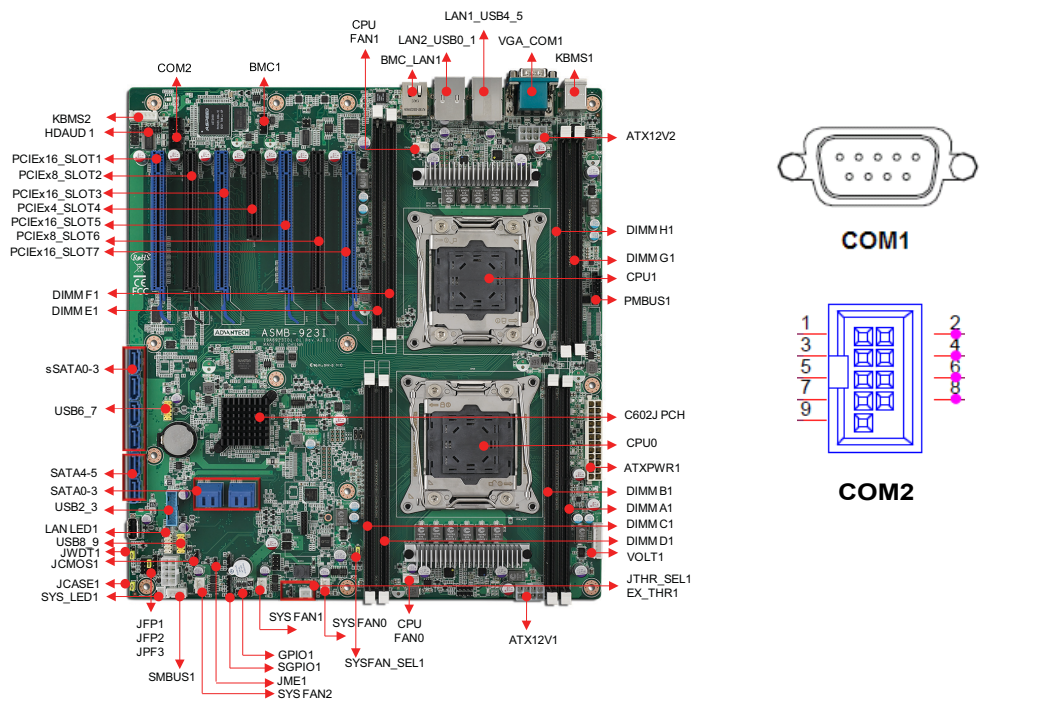

2.5 PS2 Keyboard and Mouse Connectors (KBMS1/KBMS2)

Two 6-pin mini-DIN connectors (KBMS1) on the rear panel of the motherboard provide PS/2 keyboard and mouse connections. KBMS2 connector is for additional keyboard & mouse device usage.

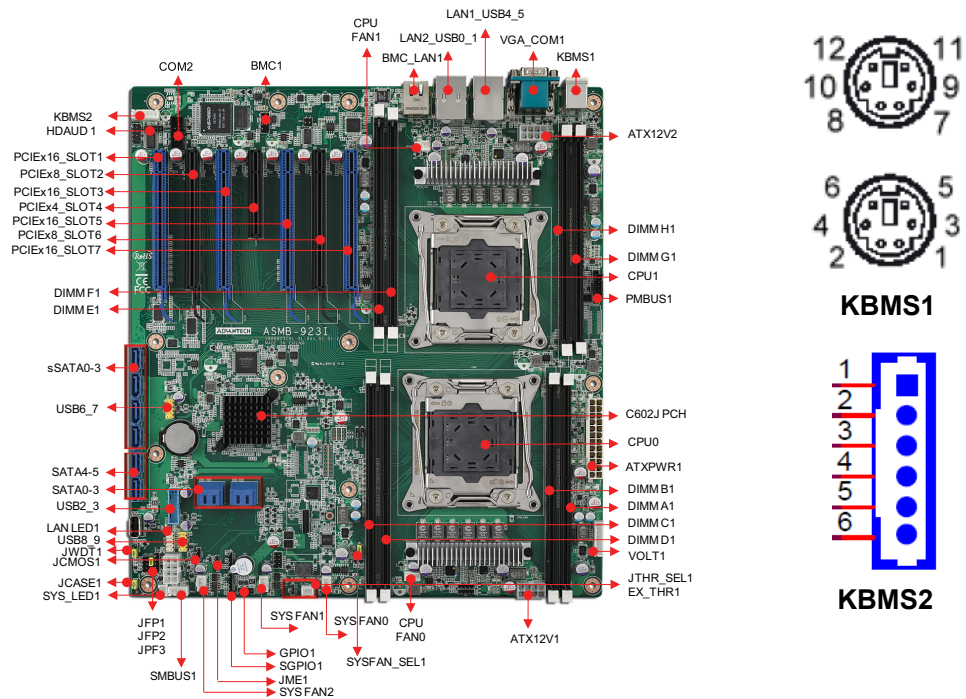

2.6 CPU Fan Connector (CPU FAN0/FAN1)

If a fan is used, this connector supports cooling fans that draw up to 500 mA (6 W).

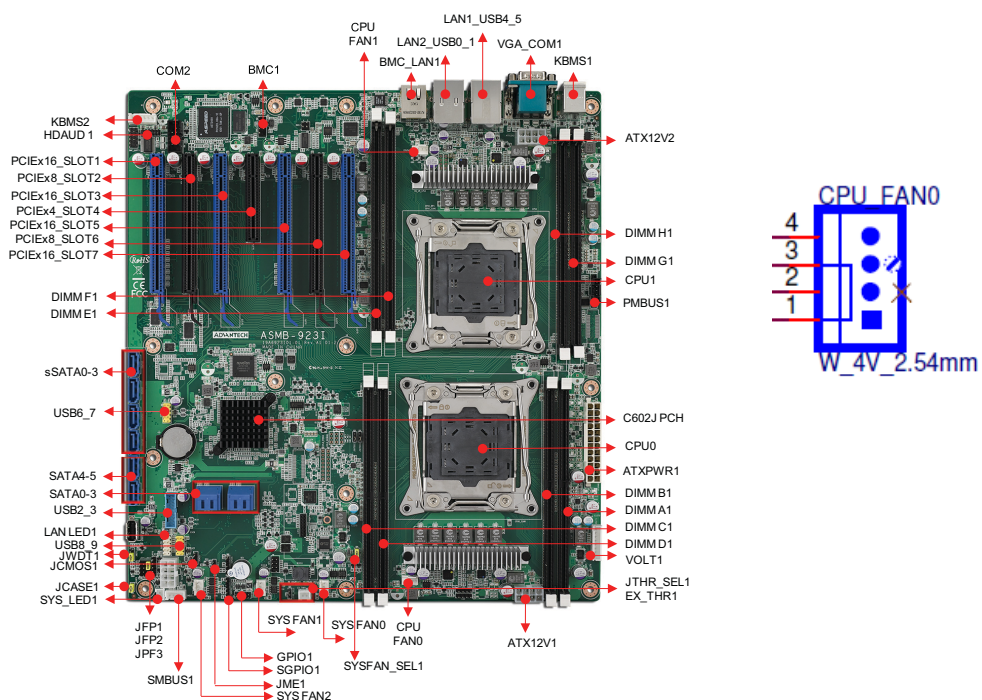

Table 2.1: CPU FAN Pin Definition

	CPU FAN0	CPU FAN1
1	GND	GND
2	+12V	+12V
3	CPU0_TACH	CPU1_TACH
4	CPU0_PWM	CPU1_PWM

2.7 System Fan Connector (SYS FAN0/FAN1/FAN2)

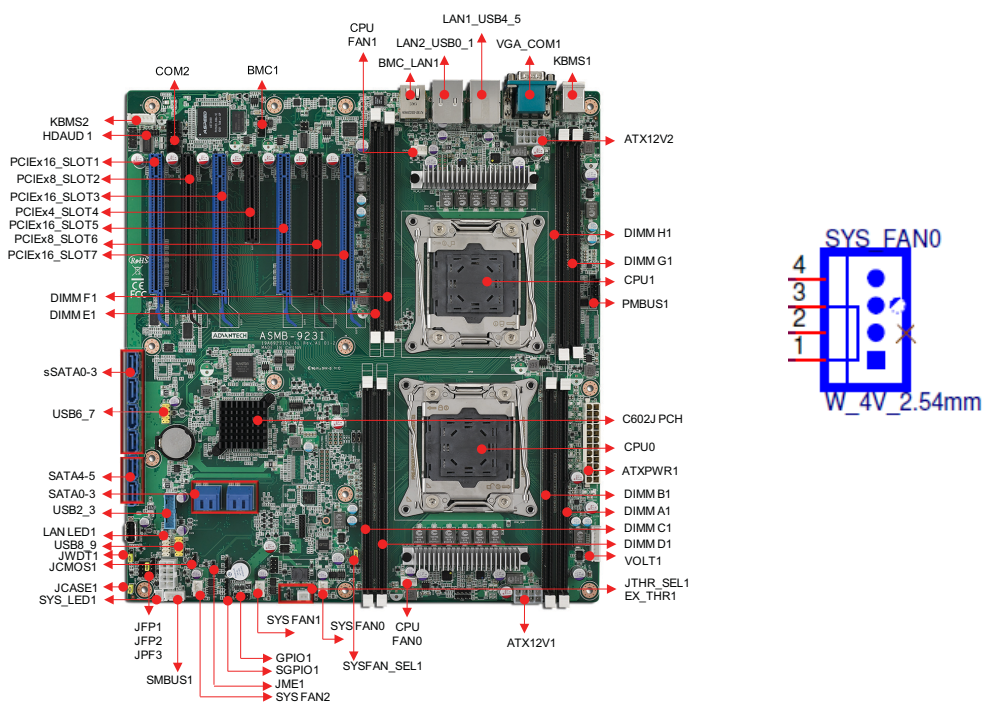
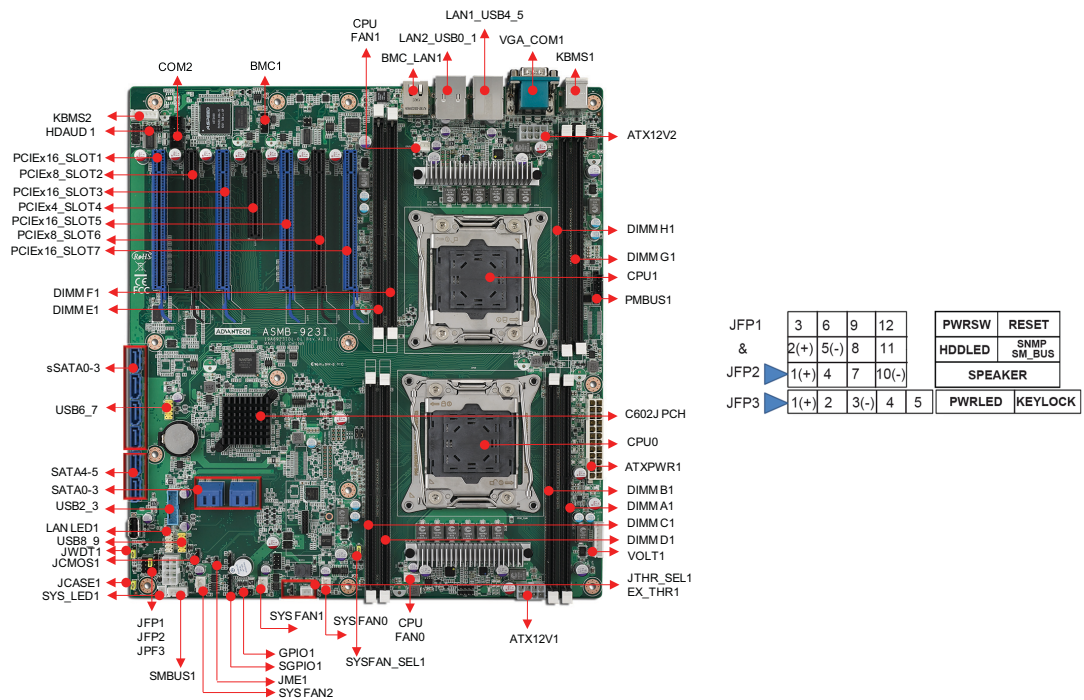

Table 2.2: SYS FAN Pin Definition

	SYS FAN0	SYS FAN1	SYS FAN2
1	GND	GND	GND
2	+12V	+12V	+12V
3	FAN0_TACH	FAN1_TACH	FAN2_TACH
4	FAN0_PWM	FAN1_PWM	FAN2_PWM

2.8 Front Panel Connector (JFP1)

There are several external switches and LEDs to monitor and control the ASMB-923I.



2.8.1 Power LED (JFP3)

JFP3 pin 1 and pin 3 are for the power LED. Refer to Appendix B for detailed information on the pin assignments. If an ATX power supply is used, the system's power LED status will be as indicated as follows.

Table 2.3: ATX Power Supply LED Status

ACPI Power Mode	LED (ATX power)
System On (S0)	On
System Standby (S1)	Fast flashes
System Hibernation(S4)	Slow flashes
System Off (S5)	Off

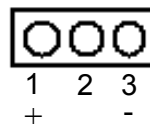

2.8.2 External Speaker (JFP2 pins 1, 4, 7, 10)

JFP2 pins 1, 4, 7, 10 connect to an external speaker. The ASMB-923I provides an onboard buzzer as an alternative. To enable the buzzer, set pins 7-10 closed.

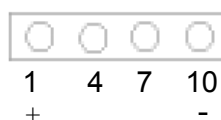

2.8.3 HDD LED Connector (JFP1 Pins 2 & 5)

You can connect an LED to connector JFP1 to indicate when the HDD is active.

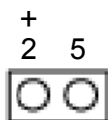

2.8.4 Reset Connector (JFP1 Pins 9 & 12)

Many computer cases offer the convenience of a reset button.

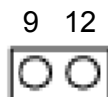

2.8.5 SNMP Connector (JFP1 Pins 8 & 11)

SNMP connector could connect with “SAB-2000” remote control board to monitor ASMB-9231 through the super IO chip.

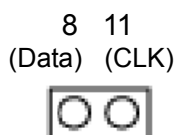

2.8.6 Case Open (JCASE1)

A Chassis Intrusion header is located at JCASE1 on the motherboard. Attach the appropriate cable from the chassis to be informed of a chassis intrusion when the chassis is opened. The default function is disabled and Pin 1-2 is bridged by a jumper cap.

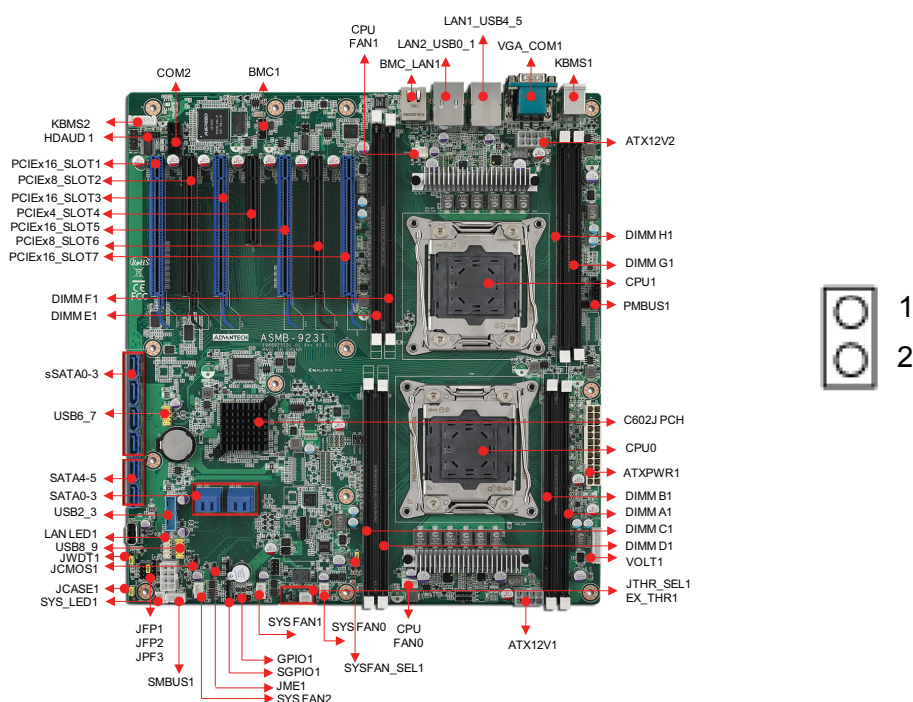

2.9 SATA SGPIO (SATA_SGPIO_1)

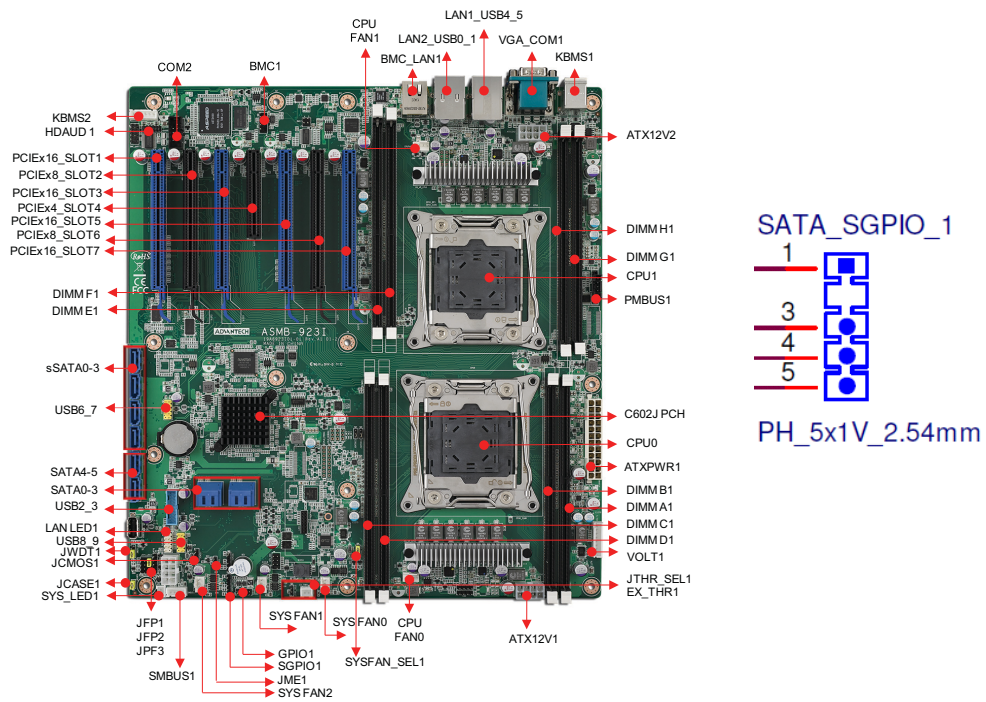

1	SCLOCK_PCH
2	NC
3	SLOAD_PCH
4	SDATAOUT0_PCH
5	SDATAOUT1_PCH

2.10 Front Panel LAN Indicator Connector (LANLED1)

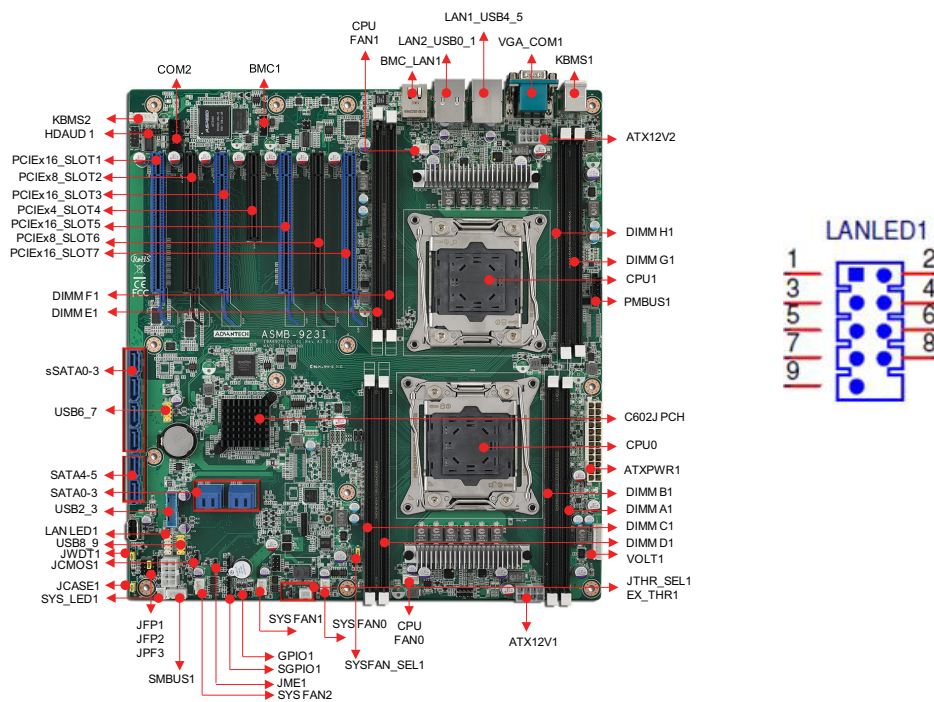

1	LAN1_LED0_ACT	2	LAN2_LED1_ACT
3	VCC3_LAN1LED	4	VCC3_LAN2LED
5	LAN1_LED1_1000M	6	LAN2_LED2_1000
7	LAN1_LED2_100M	8	LAN2_LED0_100
9	VCC3	10	NC

2.11 Serial ATA Interface (SATA0-SATA5, sSATA0-sSATA3)

ASMB-923I features ten serial ATA III interfaces (up to 600 MB/s) which eases cabling to hard drives with thin and long cables.

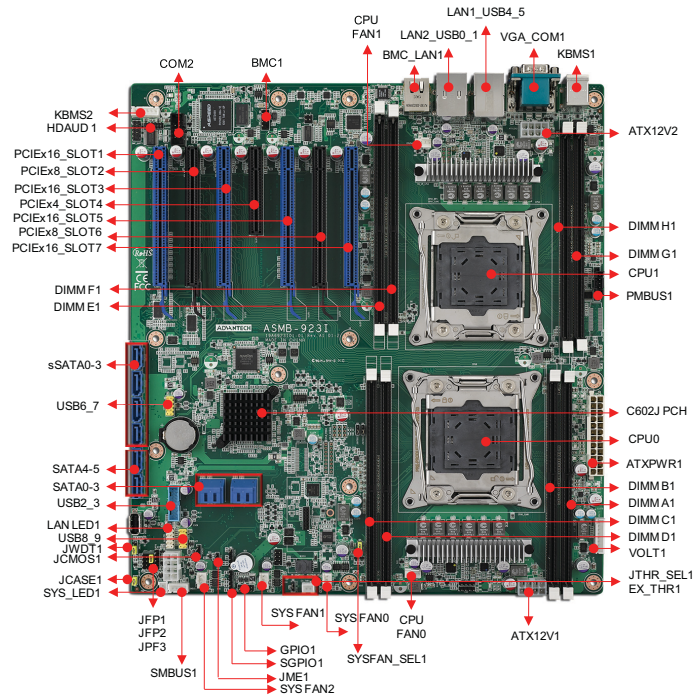

2.12 PCIe & PCI Expansion Slots

The ASMB-923I provides several expansion slots.

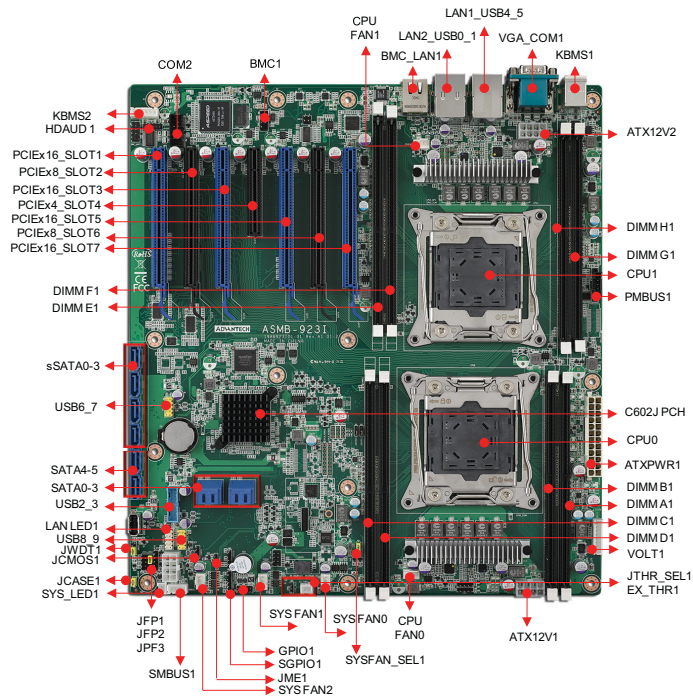

Slot	Slot Length	Link	PCI-E Generation	PCIe link provide from
SLOT1	PCI-E x16	PCI-E x16	3	CPU1
SLOT2	PCI-E x16	PCI-E x8	3	CPU1
SLOT3	PCI-E x16	PCI-E x16	3	CPU1
SLOT4	PCI-E x8	PCI-E x4	2	PCH
SLOT5	PCI-E x16	PCI-E x16	3	CPU0
SLOT6	PCI-E x16	PCI-E x8	3	CPU0
SLOT7	PCI-E x16	PCI-E x16	3	CPU0

2.13 Auxiliary Power Connector (ATXPWR1/ ATX12V1/ATX12V2)

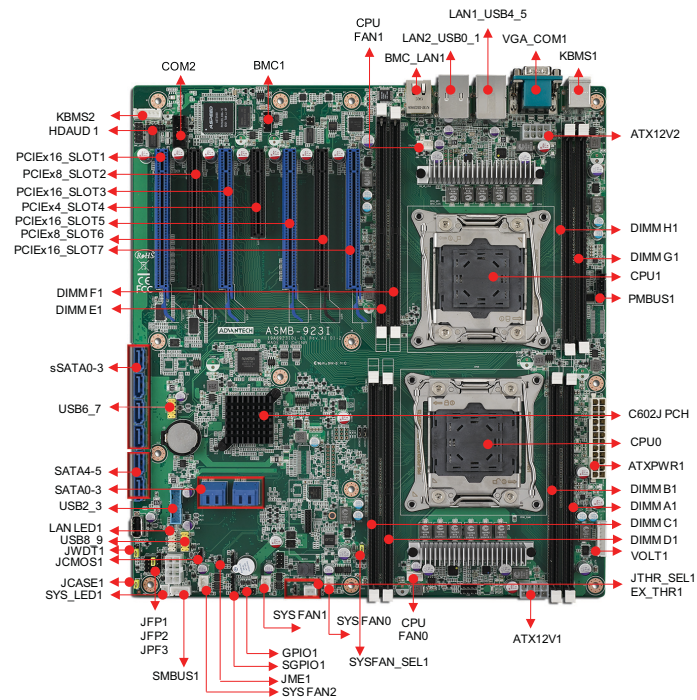

- Note!**
1. Please use a power supply which is of SSI type; minimum output should be at least 500 W.
 2. ATXPWR1 & ATX12V1 & ATX12V2 sockets should be all connected with power supply, otherwise ASMB-923I will not boot up normally.



2.14 HD Audio Interface Connector (AUDIO1)

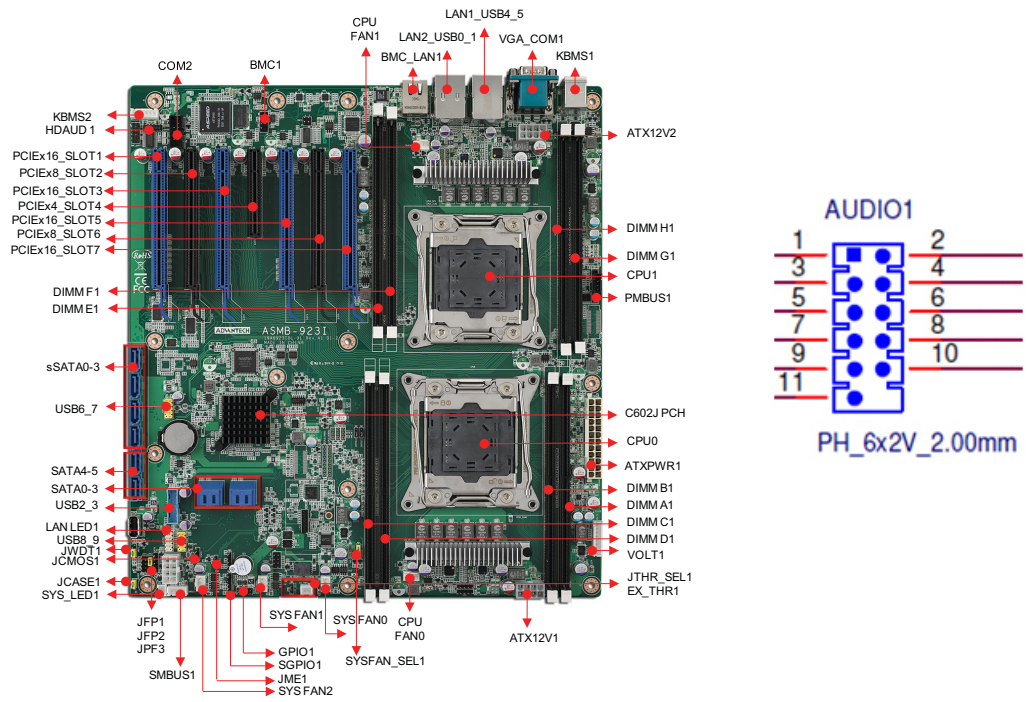

1	+5 V_AUD	2	GND
3	ACZ_SYNC	4	ACZ_BITCLK
5	ACZ_SDOUT	6	ACZ_SDIN0
7	ACZ_SDIN1	8	ACZ_RST#
9	+AC_12V	10	GND
11	GND	12	NC

2.15 LPC Connector (LPC1) for Optional TPM Module

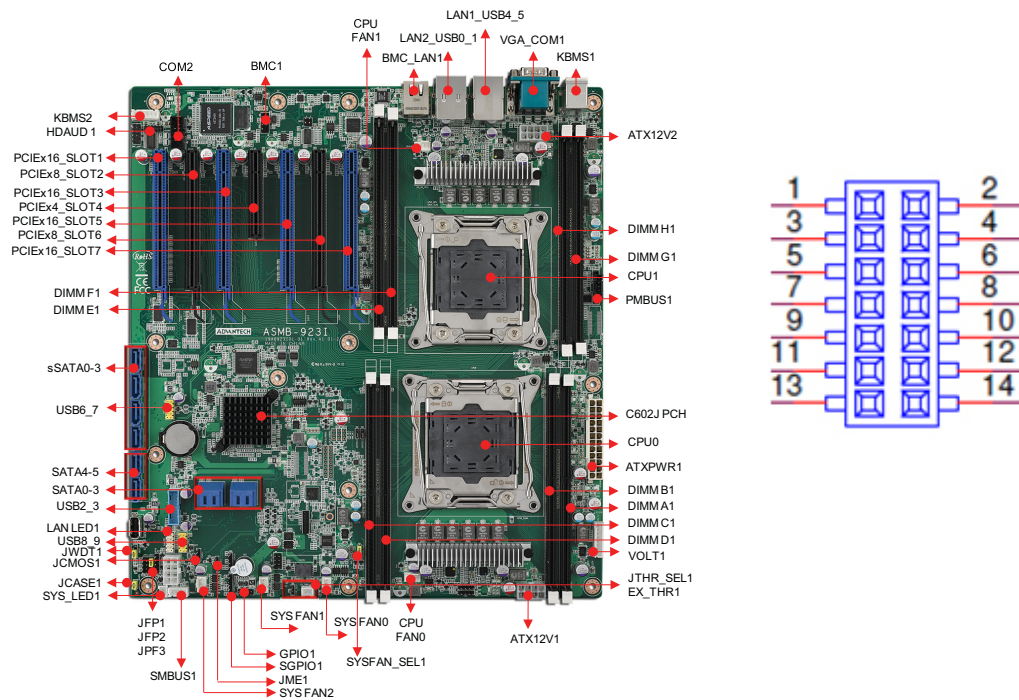

1	CLK_33M_TPM	2	LPC_AD1
3	PLTRST_LPC	4	LPC_AD0
5	LPC_FRAME	6	+3.3 V
7	LPC_AD3	8	GND
9	LPC_AD2	10	SMB_SCL_LPC
11	SERIRQ_PCH	12	SMB_SDA_LPC
13	+5V_AUX	14	+5V

2.16 Clear CMOS Connector (JCMOS1)

Setting jumper from pin 1-2 to pin 2-3, then back to pin 1-2 to reset CMOS data.

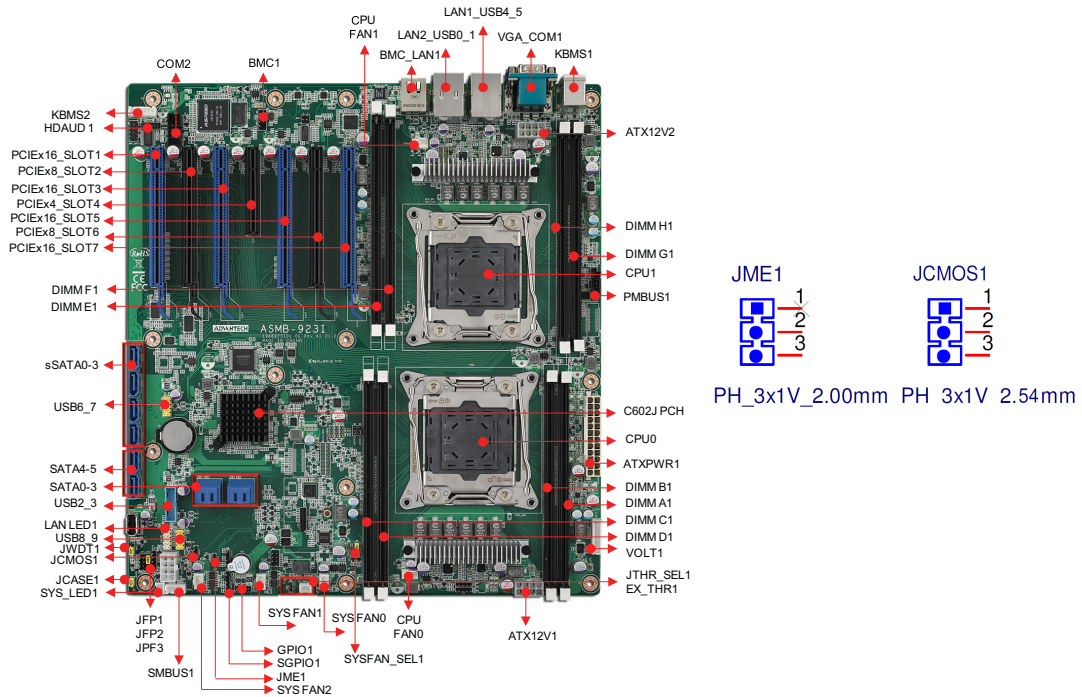

	JCMOS1	JME1
1	SRTC_RST_PCH	NC
2	RTC_RST_PCH	HDA_SDOUT_PCH
3	GND	3.3V

2.17 PMBUS Connector (PMBUS1)

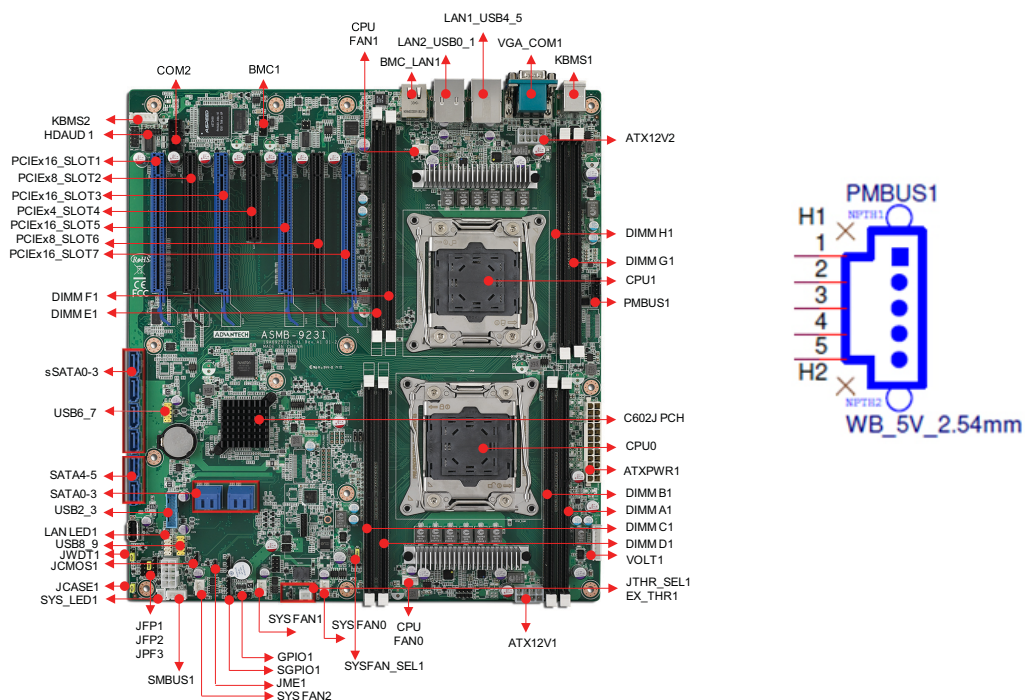

1	SMB_SCL_PM
2	SMB_SDA_PM
3	SMB_ALT_PM
4	GND
5	+3.3V

2.18 Front Panel SMBUS Connector (SMBUS1)

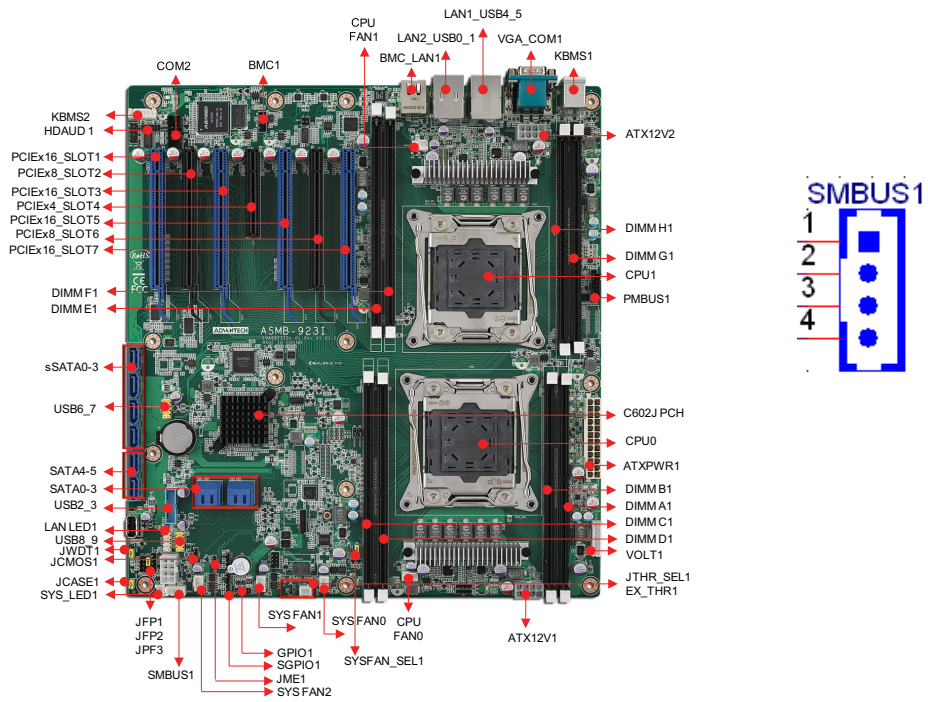

1	+3.3V_AUX
2	SMB_SCL_FRU
3	SMB_SDA_FRU
4	GND

2.19 IPMI Module Connector (BMC1)

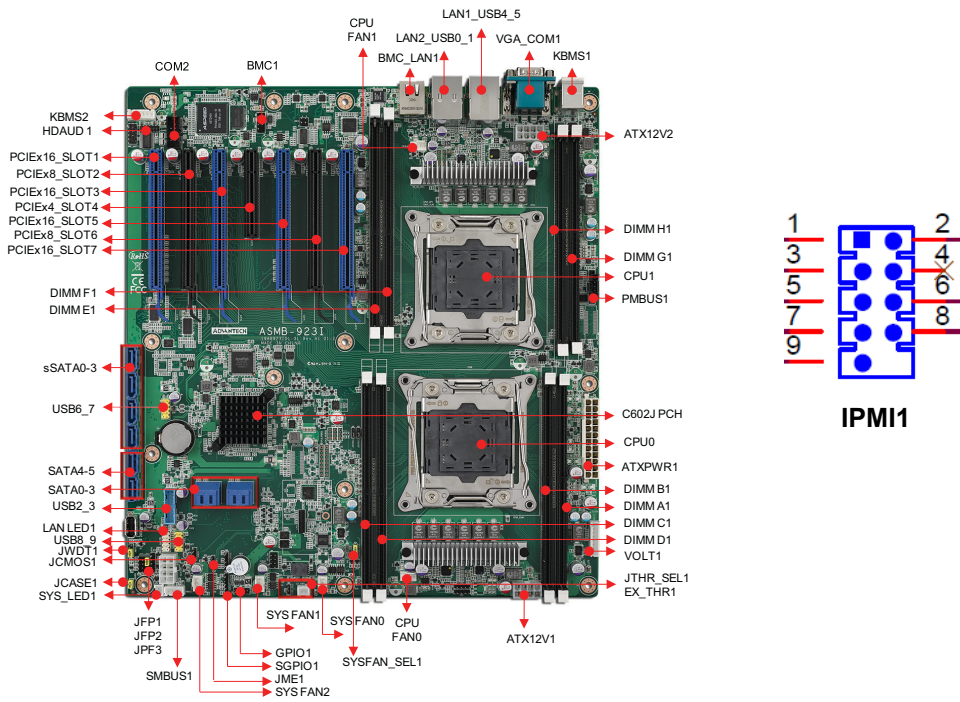

This connector will only fit to ASMB-BMC-00A1E and only exists in ASMB-9231I sku.

2.20 VOLT1 Connector

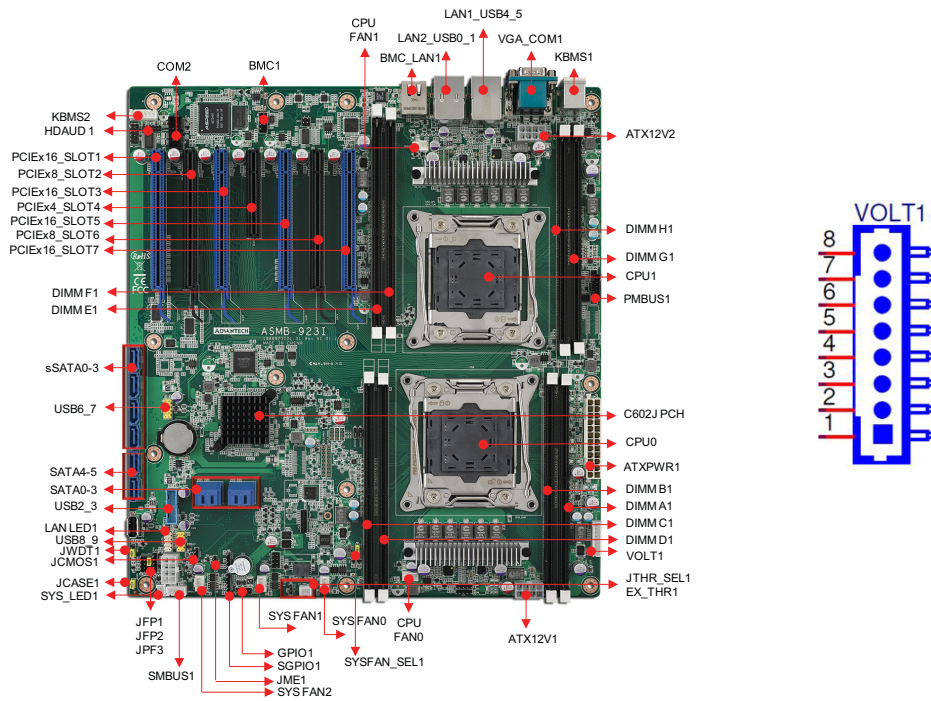

VOLT1 connects to the alarm board on the Advantech chassis. These alarm boards give warnings if a power supply or fan fails, if the chassis overheats, or if the back-plane malfunctions.

1	5VSB	5	+5V
2	GND	6	+3.3V
3	GND	7	-12V
4	-5V	8	+12V

2.21 GPIO Connector

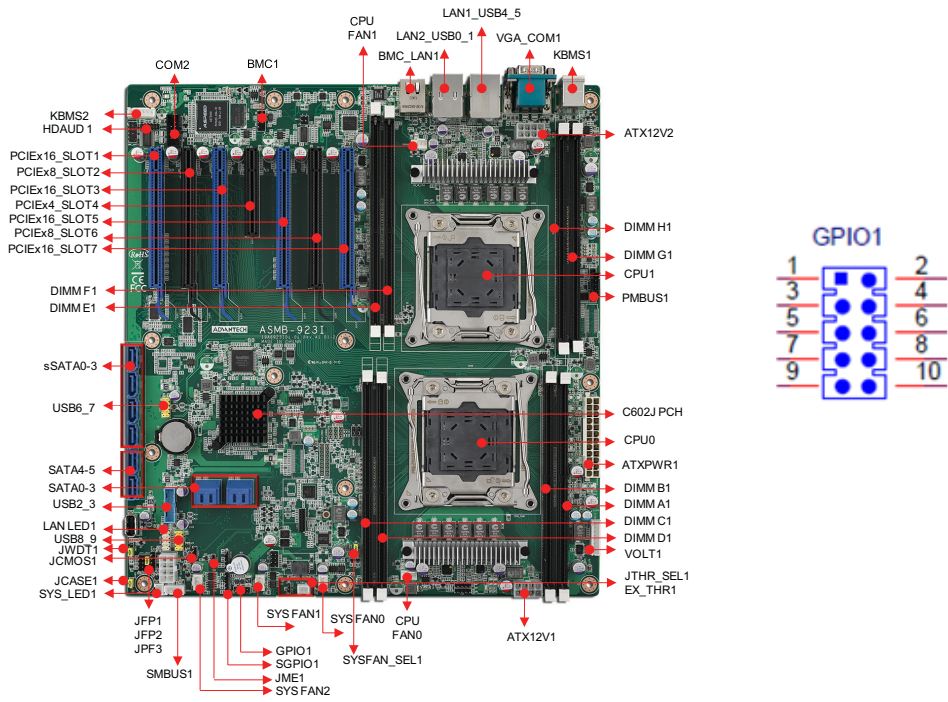

1	SIO_GPIO0	2	SIO_GPIO4
3	SIO_GPIO1	4	SIO_GPIO5
5	SIO_GPIO2	6	SIO_GPIO6
7	SIO_GPIO3	8	SIO_GPIO7
9	VCC_GPIO0	10	GND

Chapter 3

AMI BIOS

3.1 Introduction

With the AMI BIOS Setup program, you can modify BIOS settings and control the special features of your computer. The Setup program uses a number of menus for making changes and turning the special features on or off. This chapter describes the basic navigation of the ASMB-923I setup screens.

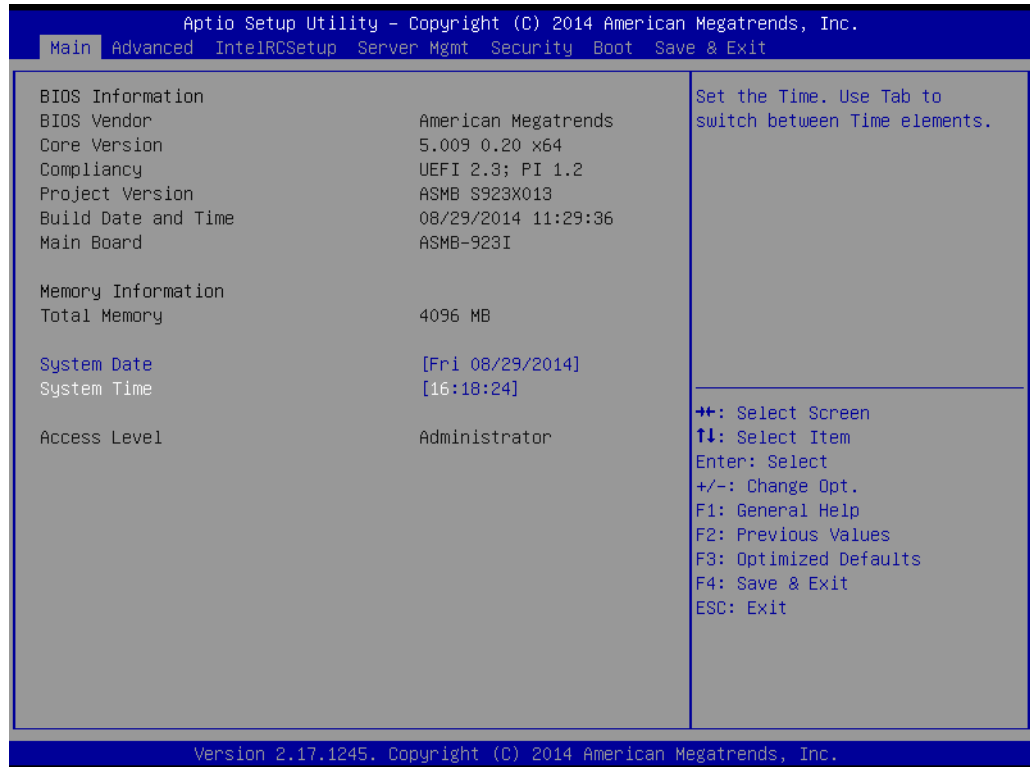

AMI's BIOS ROM has a built-in Setup program that allows users to modify the basic system configuration. This type of information is stored in battery-backed up CMOS so it retains the Setup information when the power is turned off.

Note! *The BIOS setup screens shown in this chapter are for reference only, they may not exactly match what you see on your display devices.*



3.2 BIOS Setup

3.2.1 Main Menu

Press during bootup to enter AMI BIOS CMOS Setup Utility; the Main Menu will appear on the screen. Use arrow keys to select among the items and press <Enter> to accept or enter the sub-menu.



The Main BIOS setup screen has two main frames. The left frame displays all the options that can be configured. Grayed-out options cannot be configured; options in blue can be. The right frame displays the key legend. Above the key legend is an area reserved for a text message. When an option is selected in the left frame, it is highlighted in white. Often a text message will accompany it.

■ System Time / System Date

Use this option to change the system time and date. Highlight System Time or System Date using the <Arrow> keys. Enter new values through the keyboard. Press the <Tab> key or the <Arrow> keys to move between fields. The date must be entered in MM/DD/YY format. The time must be entered in HH:MM:SS format.

3.2.2 Advanced BIOS Features Setup

Select the Advanced tab from the ASMB-923I setup screen to enter the Advanced BIOS setup screen. You can select any of the items in the left frame of the screen, such as CPU configuration, to go to the sub menu for that item. You can display an Advanced BIOS Setup option by highlighting it using the <Arrow> keys. All Advanced BIOS Setup options are described in this section. The Advanced BIOS Setup screens are shown below. The sub menus are described on the following pages.

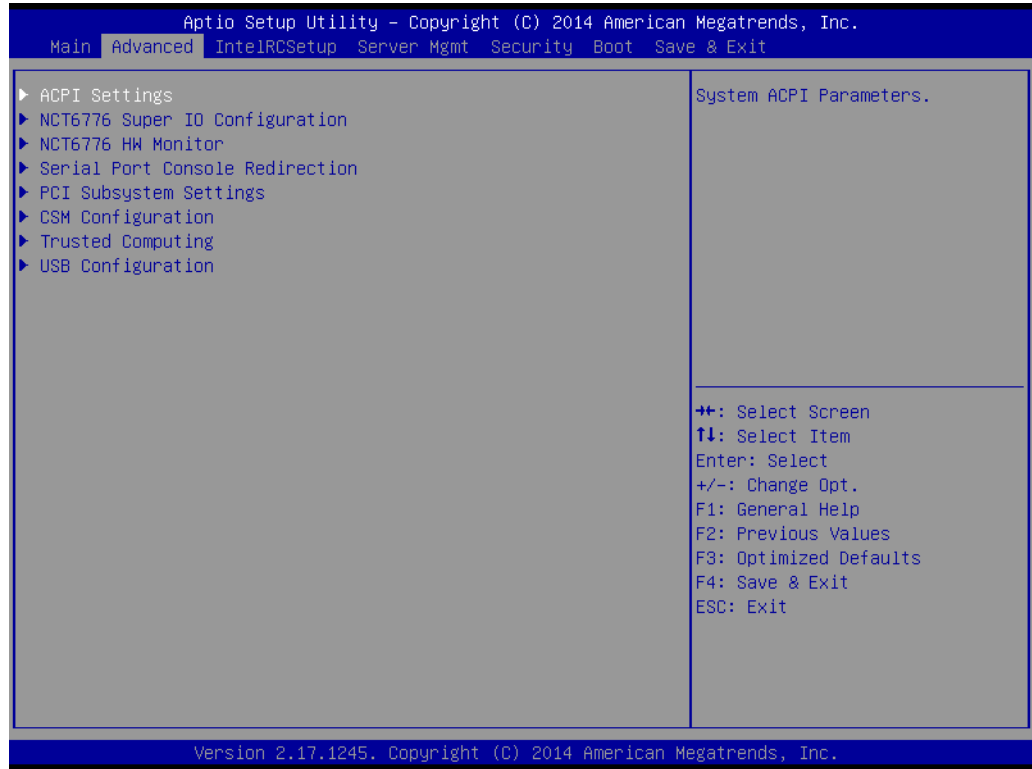

3.2.2.1 ACPI Settings



- **Enable Hibernation**
"Enable or disable" Hibernation.
- **Lock Legacy Resources**
"Enable" or "Disable" Lock Legacy Resources.

3.2.2.2 NCT6776 Super IO Configuration

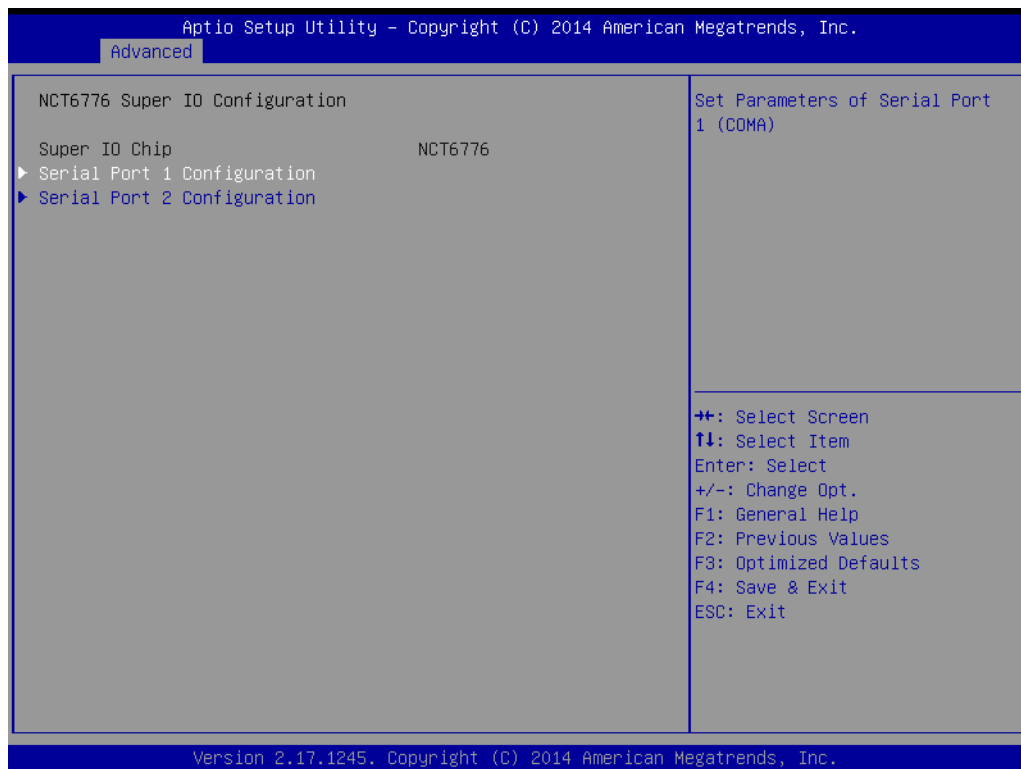

■ Serial Port 1 Configuration

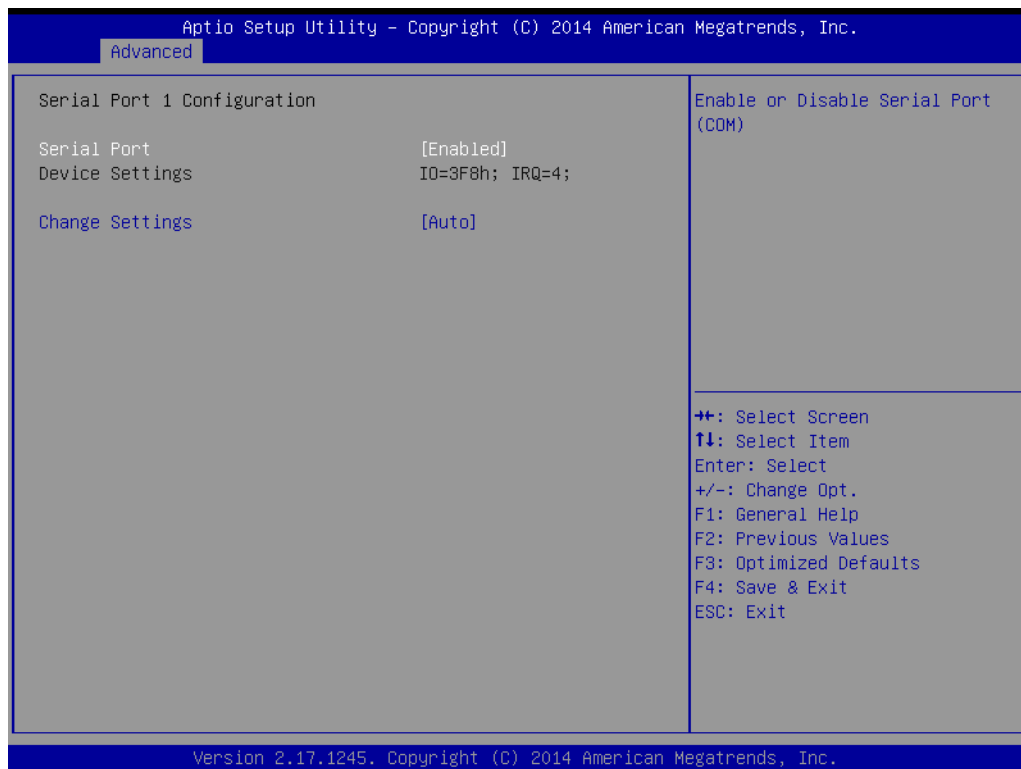

- **Serial Port**
"Enable" or "Disable" Serial Port 1.
- **Change Settings**
To select an optimal setting for serial port 1.

■ Serial Port 2 Configuration

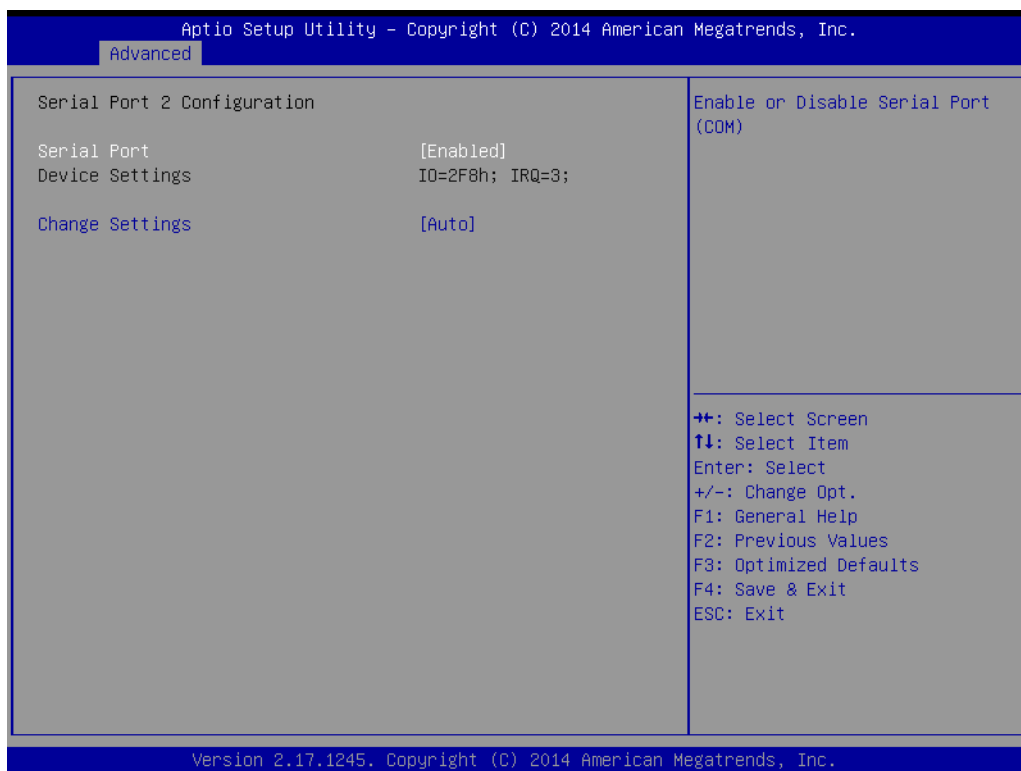

- **Serial Port**
"Enable" or "Disable" Serial Port 2.
- **Change Settings**
To select an optimal setting for serial port 2.

3.2.2.3 NCT6776 HW Monitor

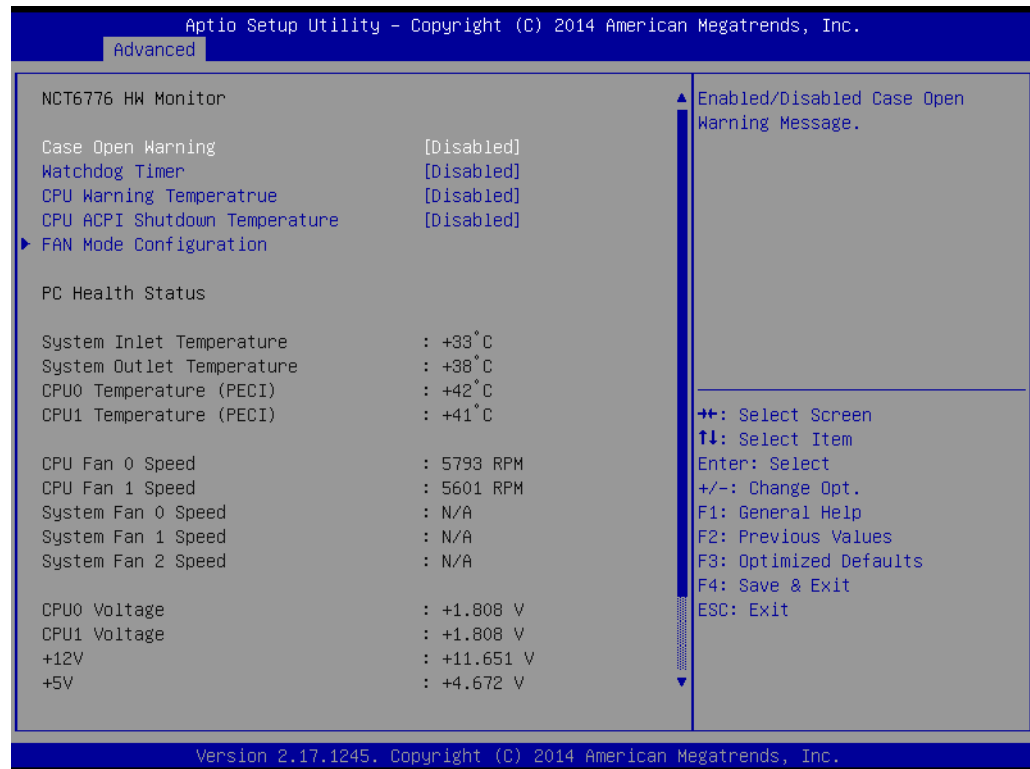

- **Case Open Warning**
Enable/Disable the Chassis Intrusion monitoring function. When enabled and the case is opened, the warning message will show in POST screen.
- **Watchdog Timer**
Enable and Disable the watchdog timer function.
- **CPU Warning Temperature**
Set the CPU warning temperature threshold. When the system reaches the warning temperature, the speaker will beep.
- **ACPI Shutdown Temperature**
Set the ACPI shutdown temperature threshold. When the system reaches the shutdown temperature, it will be automatically shut down by ACPI OS to protect the system from overheat damage.
- **Fan Mode Configuration**
When set to manual mode, fan duty setting can be changed; the range is from 30%~100%, default setting is 50%.

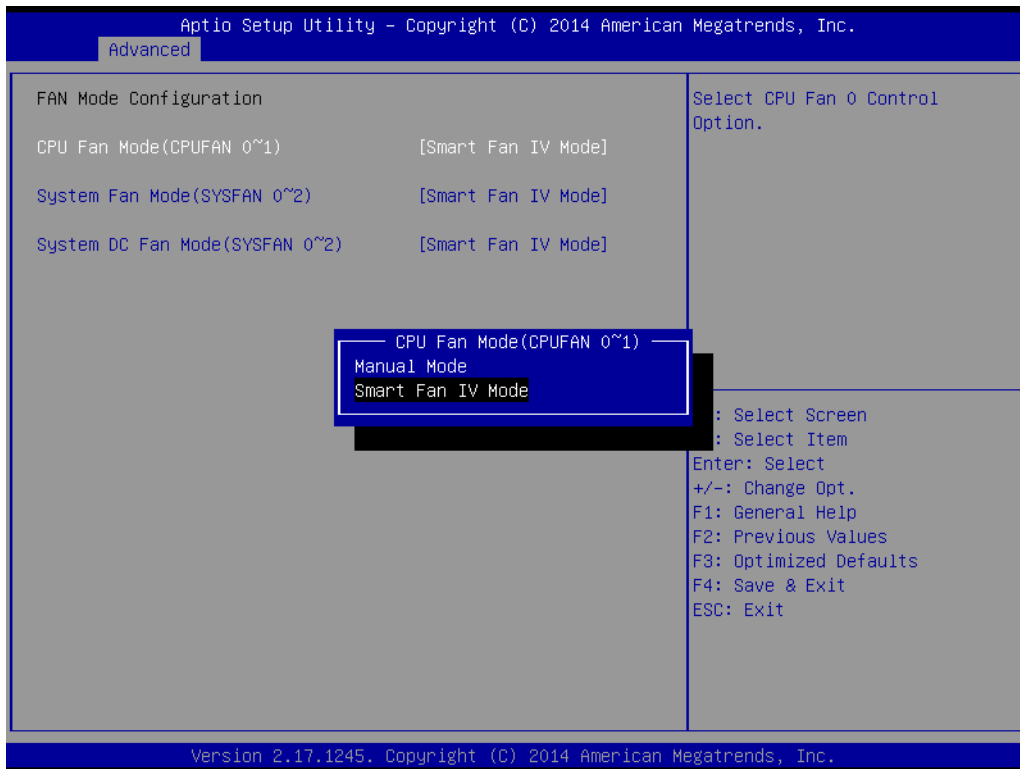

3.2.2.4 Serial Port Console Redirection

■ Console Redirection

To "Enable or disable" console redirection feature.

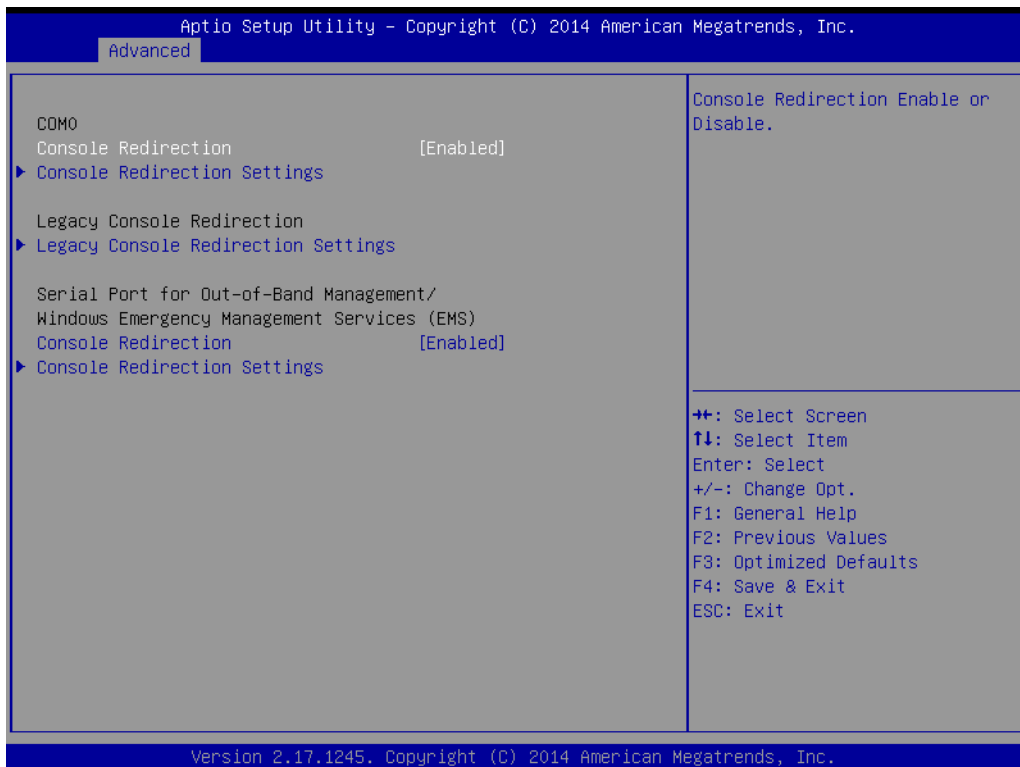

■ Console Redirection Settings

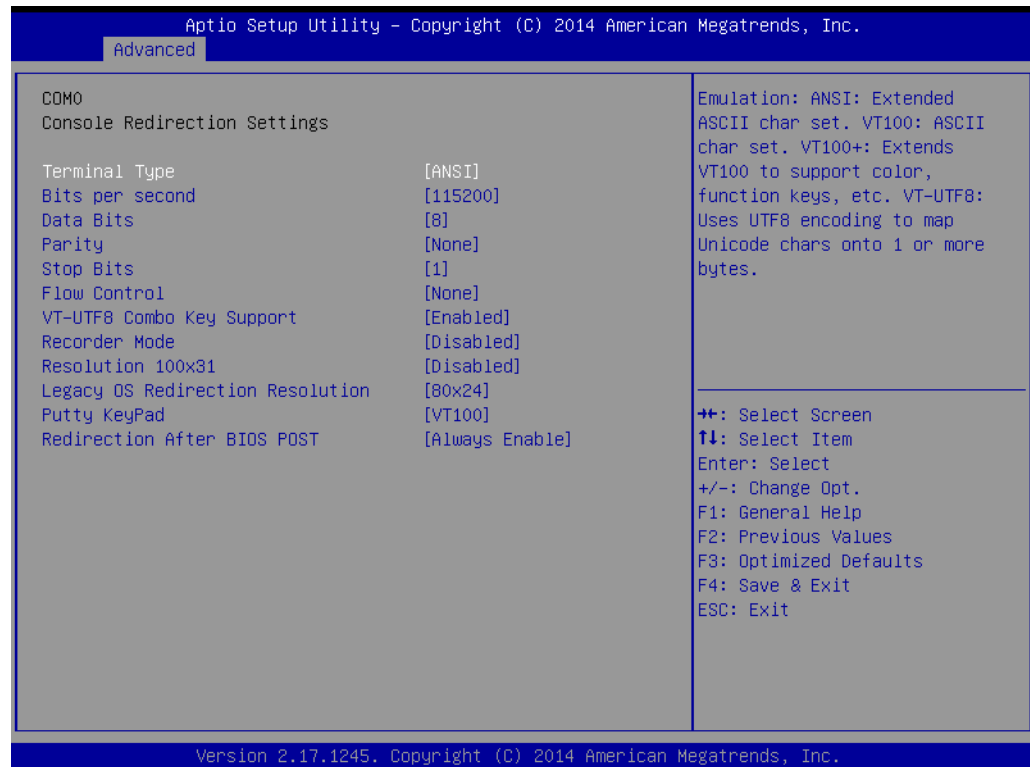

- **Terminal Type**
Select a terminal type to be used for console redirection.
Options available: VT100/VT100+/ANSI /VT-UTF8.
- **Bits Per Second**
Select the baud rate for console redirection.
Options available: 9600/19200/57600/115200.
- **Parity**
A parity bit can be sent with the data bits to detect some transmission errors.
Even: parity bit is 0 if the number of 1's in the data bits is even.
Odd: parity bit is 0 if number of 1's the data bits is odd.
Mark: parity bit is always 1. Space: Parity bit is always 0.
Mark and Space Parity do not allow for error detection.
Options available: None/Even/Odd/Mark/Space.
- **Stop Bits**
Stop bits indicate the end of a serial data packet. (A start bit indicates the beginning). The standard setting is 1 stop bit. Communication with slow devices may require more than 1 stop bit.
Options available: 1/2.
- **Flow Control**
Flow control can prevent data loss from buffer overflow. When sending data, if the receiving buffers are full, a 'stop' signal can be sent to stop the data flow. Once the buffers are empty, a 'start' signal can be sent to re-start the flow. Hardware flow control uses two wires to send start/stop signals.
Options available: None/Hardware RTS/CTS.
- **Recorder Mode**

When this mode enabled, only text will be send. This is to capture Terminal data.

Options available: Enabled/Disabled.

- **Legacy OS Redirection Resolution**

On Legacy OS, the number of rows and columns supported redirection.

Options available: 80x24/80X25.

- **Putty Keypad**

Select function key and keypad on putty.

- **Console Redirection Setting**

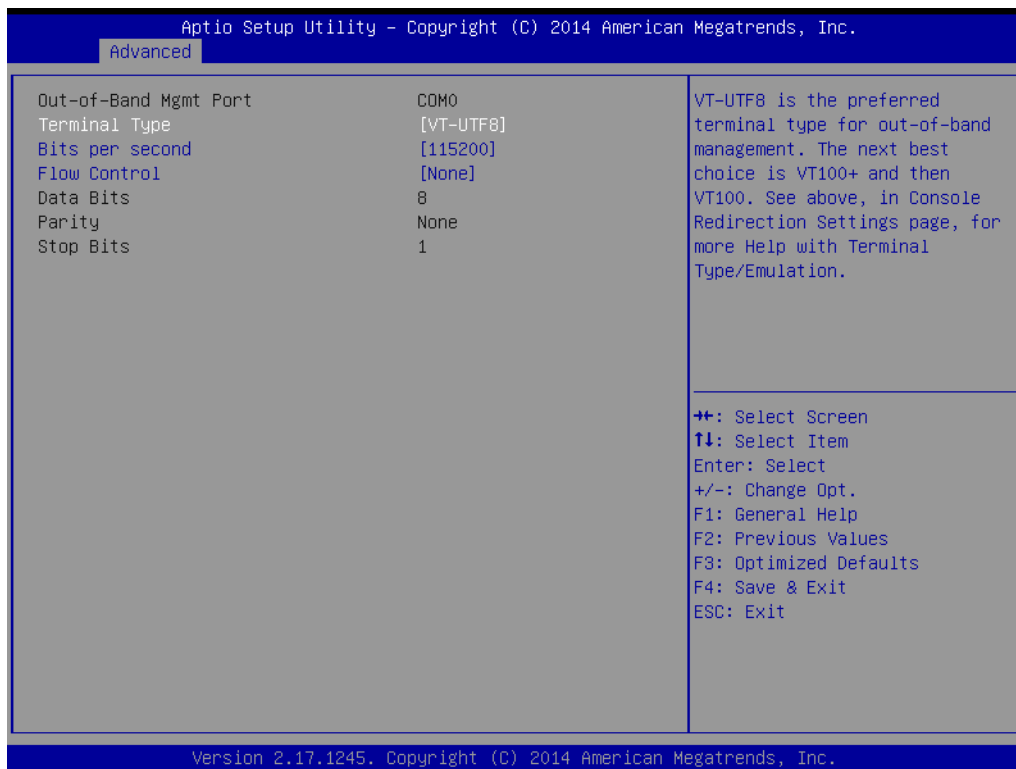

- **Out-of-Band Mgmt Port**

To select the com port user would like to set for having console redirection feature.

- **Terminal Type**

Set as "VT100", "VT100+", "VT-UTF8", or "ANSI". "VT-UTF8" is the default setting.

- **Bits Per Second**

To select serial port transmission. Speed must be matched on the other side. It can be set as "9600", "19200", "57600", or "115200". "115200" is the default setting.

- **Flow Control**

Flow control can prevent data loss from buffer overflow. It can be set as "None",

"Hardware RTS/CTS", or "Software Xon/Xoff". "None" is the default setting.

3.2.2.5 PCI Subsystem Settings

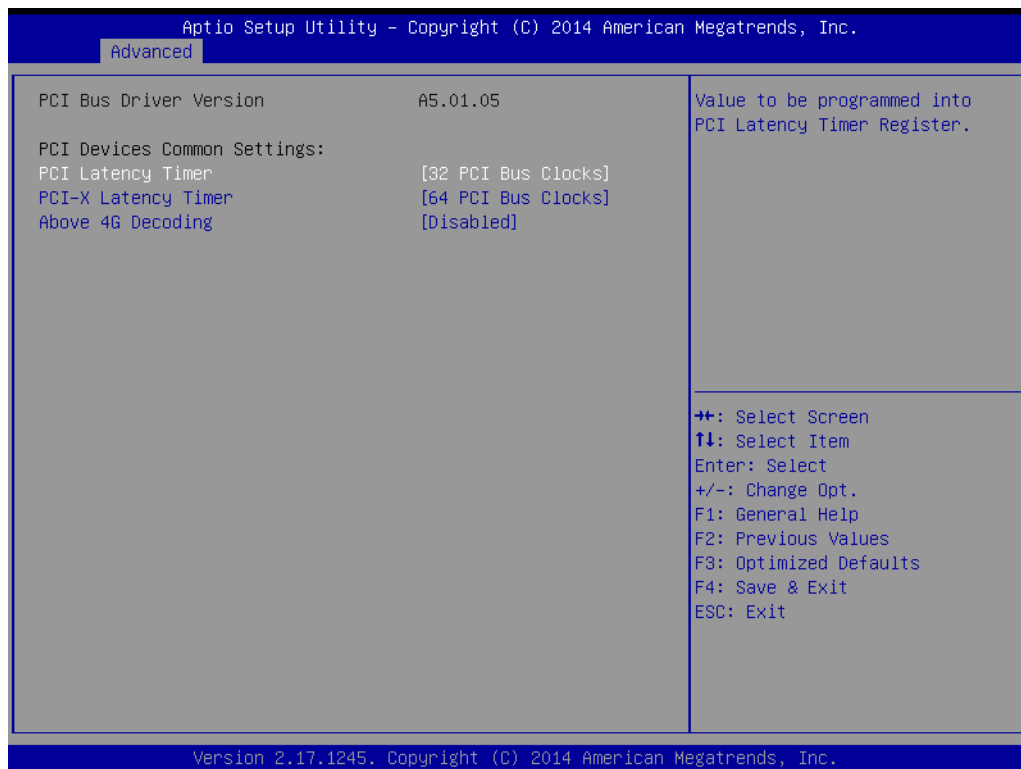

- **PCI / PCI-X Latency Timer**
Value in units of PCI clocks for PCI device latency timer register.
- **Above 4G Decoding**
Enables or disables 64-bit capability. Devices to be decoded in above 4G address space (Only if system supports 64-bit PCI decoding).

Note! *Some graphic or GPU cards need to enable 4G Decoding.*



3.2.2.6 CSM Configuration

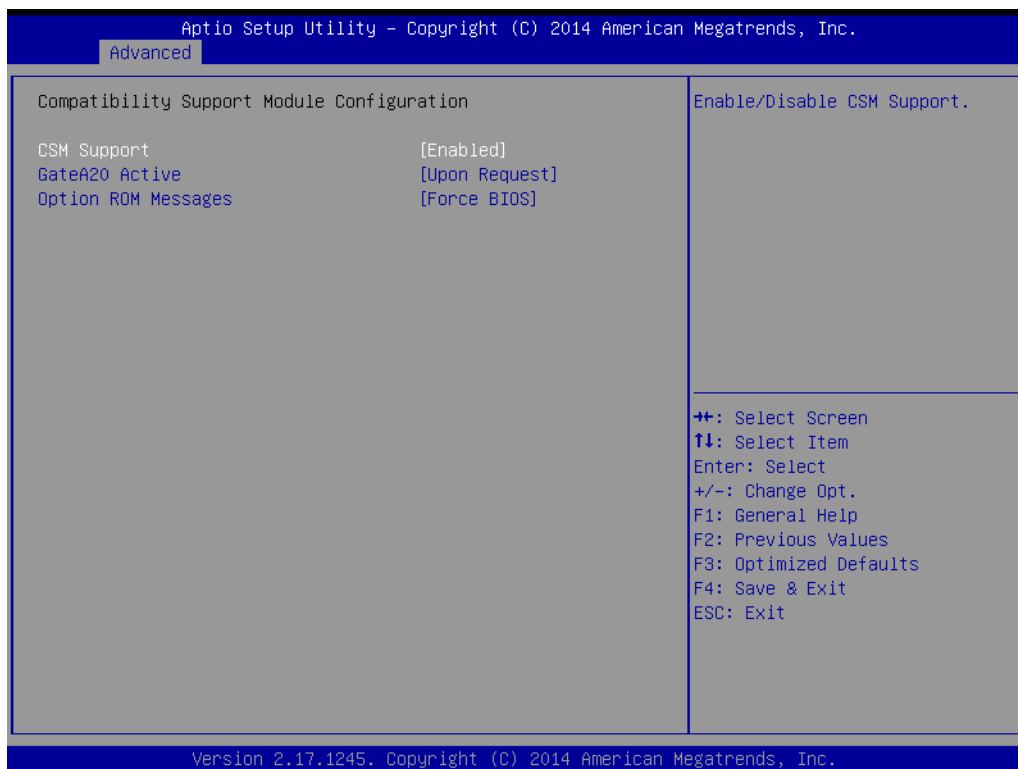

- **CSM Support**
Enables or disables UEFI CSM (Compatibility Support Module) to support a legacy PC boot process.
- **GateA20 Active**
This item is useful when RT code is executed above 1MB. When this is set as "UPON REQUEST", GA20 can be disabled using BIOS services. When it is set as "Always", it does not allow disabling GA20.
- **Option ROM Messages**
"Force BIOS or Keep Current" to set the display mode for Option ROM

3.2.2.7 Trusted Computing



- **Security Device Support**

Enables or disables BIOS support for security device.

Purchase Advantech LPC TPM module to enable TPM function. P/N: PCATPM-00A1E.

3.2.2.8 USB Configuration

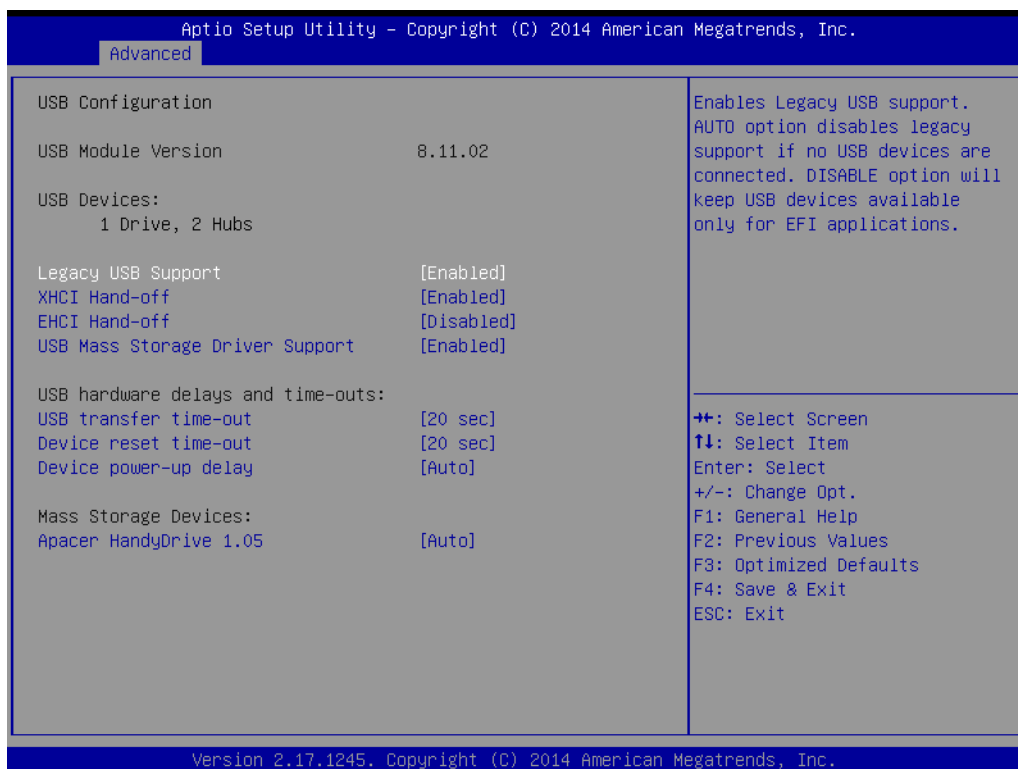

- **Legacy USB Support**
This is for supporting USB device under a legacy OS such as DOS. When choosing "AUTO", the system will automatically detect if any USB device is plugged into the computer and enable USB legacy mode when a USB device is plugged and disable USB legacy mode when no USB device is attached.
- **XHCI Hand-off**
This is a workaround for OS without XHCI hand-off support.
The XHCI ownership change should be claimed by XHCI driver.
- **EHCI Hand-off**
This is a workaround for OS without EHCI hand-off support.
The EHCI ownership change should be claimed by EHCI driver.
- **USB Mass Storage Driver Support**
Enable/Disable USB mass storage driver support.
- **USB Transfer Time-out**
Selects the USB transfer time-out value. [1,5,10,20sec]
- **Device Reset Time-out**
Selects the USB device reset time-out value. [10,20,30,40 sec]
- **Device Power-up Delay**
This item appears only when Device power-up delay item is set to [manual].

3.2.3 IntelRCSetup

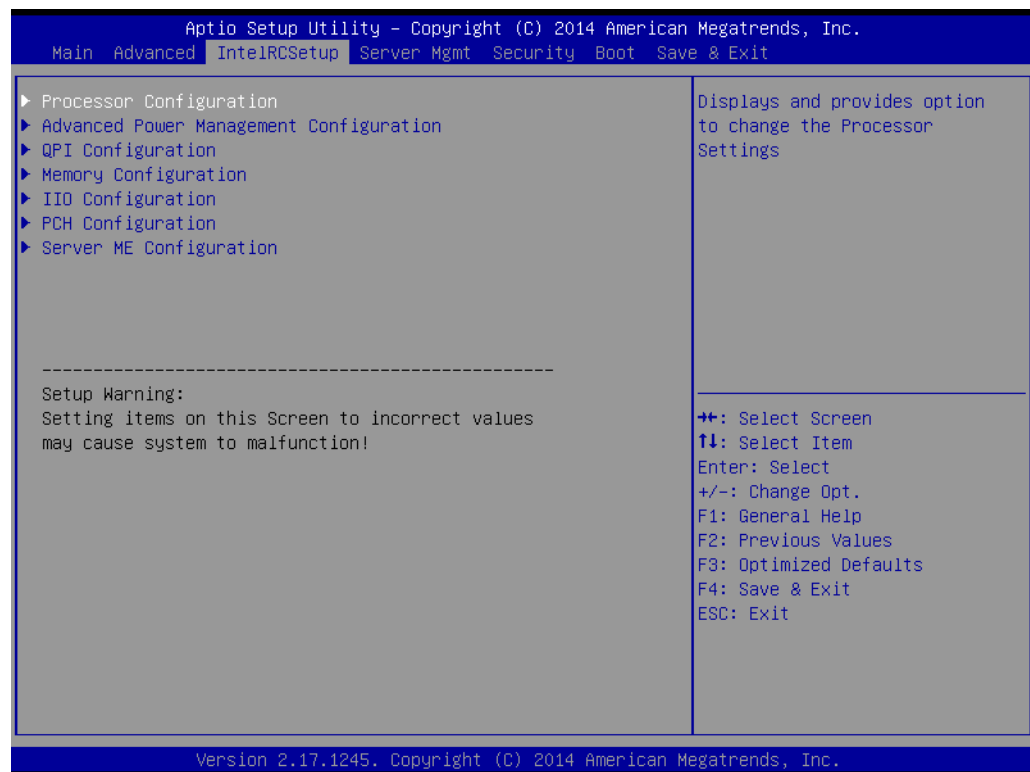

3.2.3.1 Processor Configuration

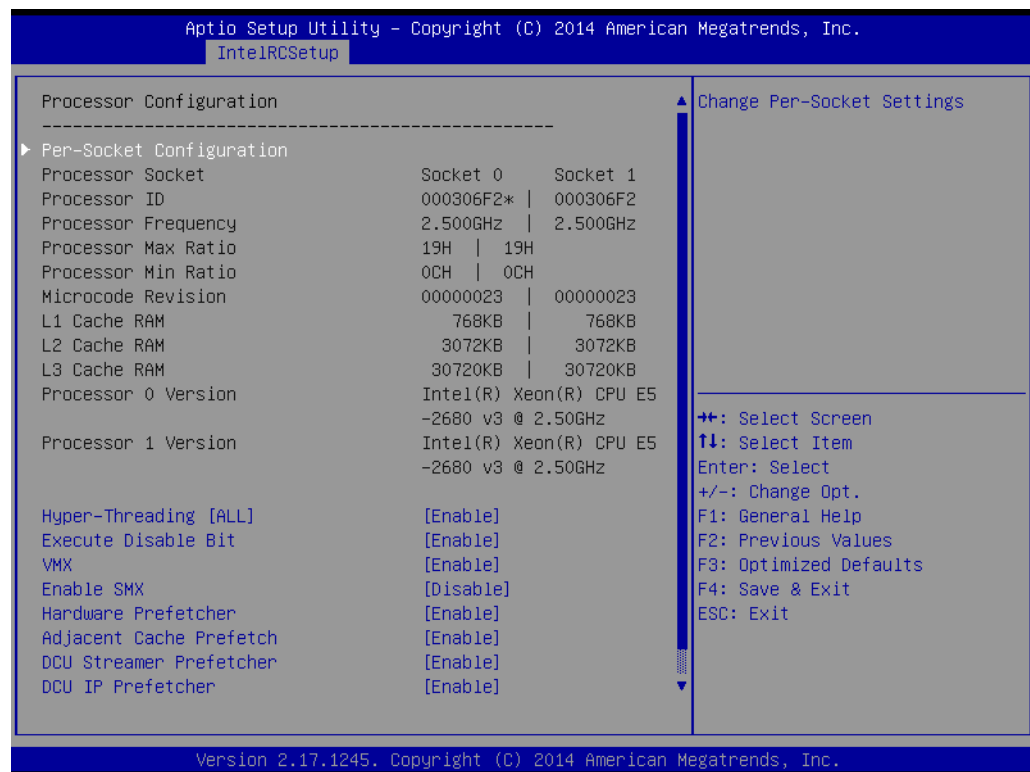

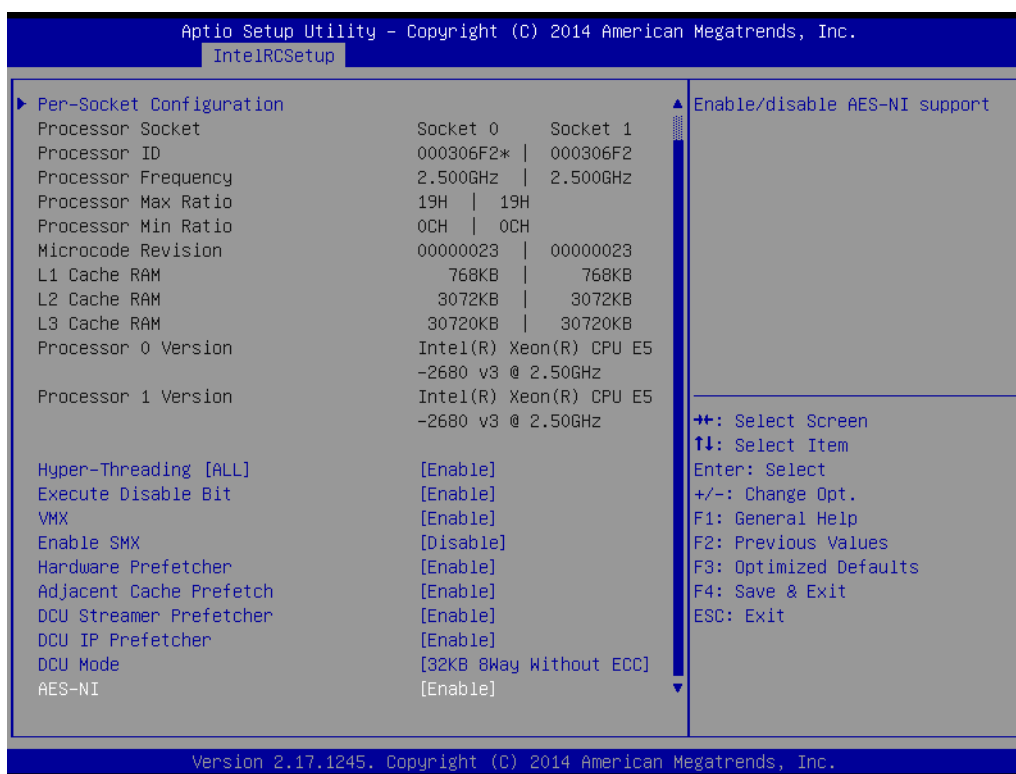

- **Per-Socket Configuration**
Use this to select how many processor cores you want to activate when you are using a dual or quad core processor.
- **Hyper-threading**
Enable or disable Intel Hyper Threading technology.
- **Execute Disable Bit**
This item specifies the Execute Disable Bit Feature. The settings are Enabled and Disabled. The Optimal and Fail-Safe default setting is Enabled. If Disabled is selected, the BIOS forces the XD feature flag to always return to 0.
- **VMX**
Enable or disable Intel Virtual Machine Extensions (VMX) for IA-32 processors that support Intel® Vanderpool Technology
- **SMX**
Enable or disable the Safer Mode Extensions. Safer Mode Extensions (SMX) provide a means for system software to launch an MLE and establish a measured environment within the platform to support trust decisions by end users.
- **Hardware Prefetcher**
Hardware Prefetcher is a technique that fetches instructions and/or data from memory into the CPU cache memory well before the CPU needs it, so that it can improve the load-to-use latency. You may choose to enable or disable it.
- **Adjacent Cache Line Prefetch**
The Adjacent Cache-Line Prefetch mechanism, like automatic hardware prefetch, operates without programmer intervention. When enabled through the BIOS, two 64-byte cache lines are fetched into a 128-byte sector, regardless of whether the additional cache line has been requested or not. You may choose to enable or disable it.

- **DCU Streamer Prefetcher**
Enable prefetch of next L1 data line based upon multiple loads in same cache line.
- **DCU IP Prefetcher**
Enable prefetch of next L1 line based upon sequential load history.
- **DCU Mode**
Change the data cache unit (DCU) mode.
- **AES-NI**
This item is to enable or disable CPU advanced encryption standard instructions.

3.2.3.2 Advanced Power Management

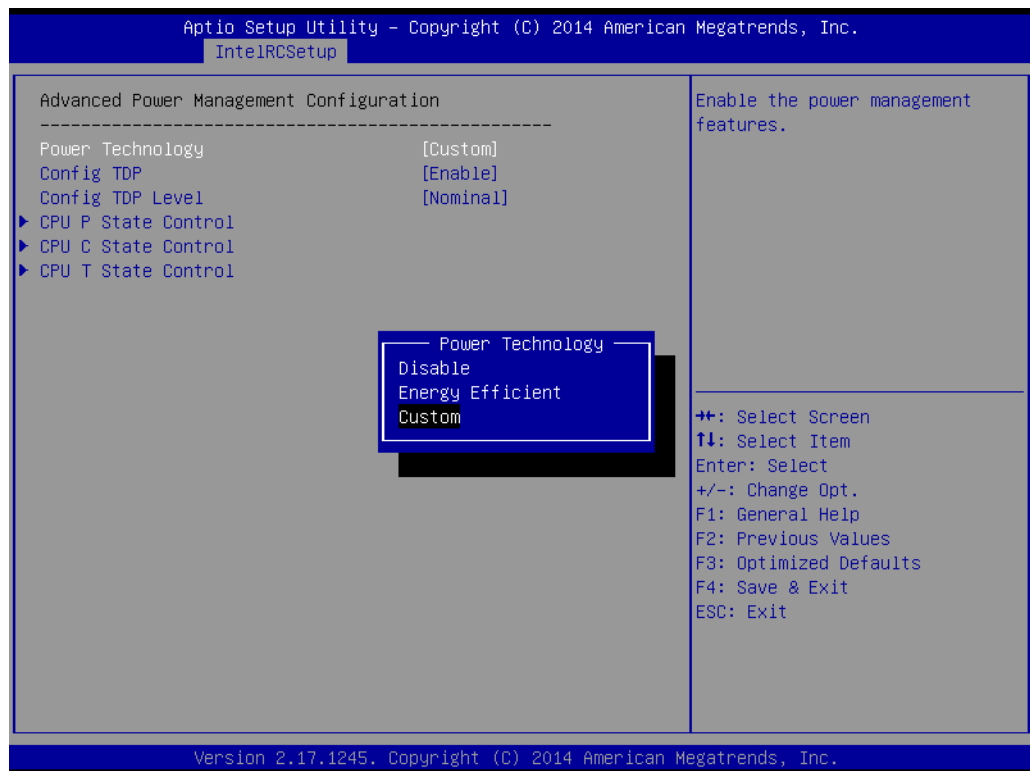

- **Power Technology**
Power technology default is "Energy Efficient". User can set "EIST", "P-STATE", "C3", "C6", "Package C State limit" under "Custom" Mode.

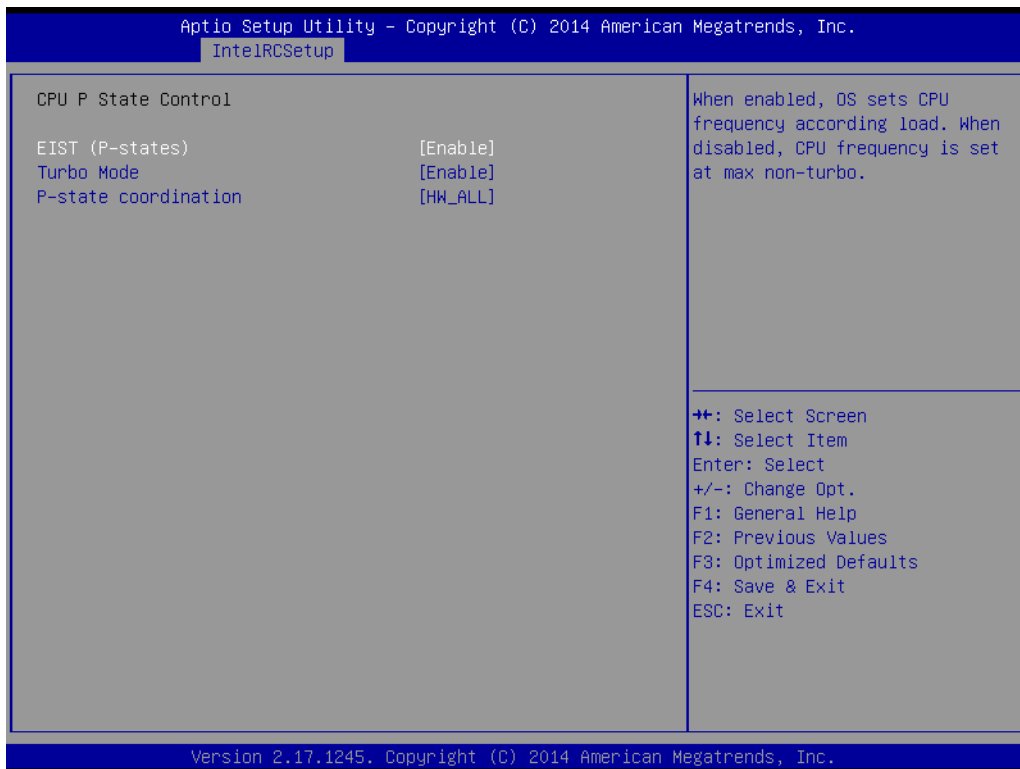

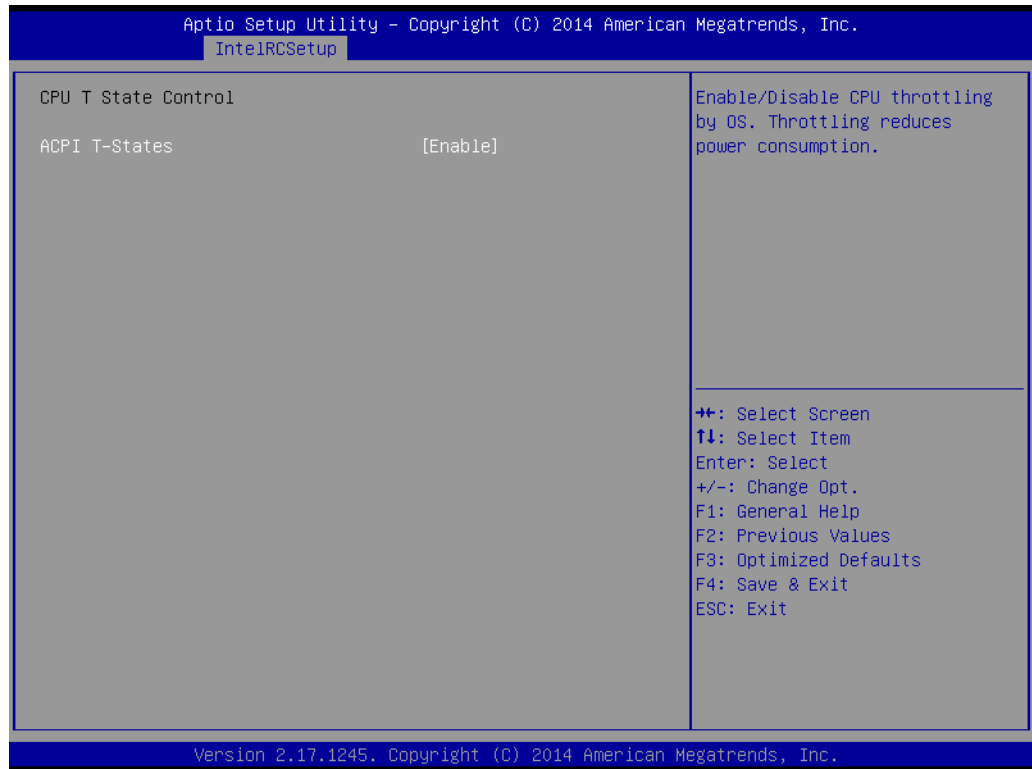

3.2.3.3 QPI Configuration



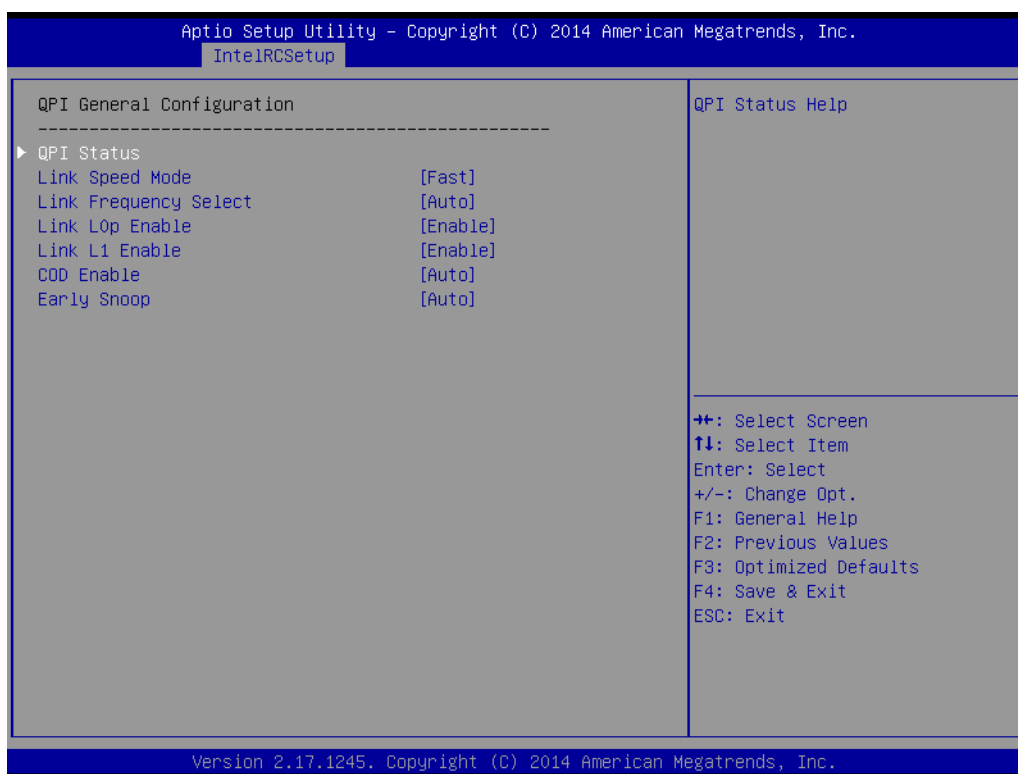

- **QPI Speed Mode**
Select the QPI link speed as either the Fast mode or Slow Mode.
- **QPI Frequency Select**
Allows for selecting the QPI Link frequency.
- **QPI Link0p**
Enable/Disable QPI Link0p.
- **QPI Link1**
Enable/Disable QPI Link1.
- **COD enable**
Enable/Disable Cluster on Die.
- **Early Snoop**
Enable/Disable Early Snoop.

Note!

1. *Intel® recommends exposing all 3 snoop modes as BIOS options to the user due to the varying memory latency & bandwidth trade-offs across SKUs for each snoop mode.*
 - a). *Intel® Xeon® Processor E5-2600 v3 Product Family supports up to 3 different snoop modes (Early Snoop, Home Snoop, Cluster on Die) to maintain memory coherency across the 2 sockets.*
 - b). *Choosing the optimal snoop mode setting is dependent on the workload characteristics and the SKU that is used.*
2. *It is expected behavior for LCC SKUs (4-8 cores) in NUMA & Early Snoop mode to have low remote bandwidth.*
 - a). *For workloads on LCC SKUs that need high local & remote memory bandwidth, use NUMA & Home Snoop mode at the expense of higher memory latency (up to 1.07x).*
 - b). *For workloads on LCC SKUs that have mostly remote memory accesses, use UMA & either Early Snoop or Home Snoop mode.*

Snoop Mode Configuration	Cluster on Die Enable	Early Snoop Mode
Early Snoop (ES)	Disable	Enable
	Auto	Auto
	Auto	Enable
	Disable	Auto
Home Snoop (HS)	Disable	Disable
	Auto	Disable
Cluster on Die (COD)	Enable	Disable
	Enable	Auto
Not Supported - Invalid Settings	Enable	Enable

3.2.3.4 Memory Configuration

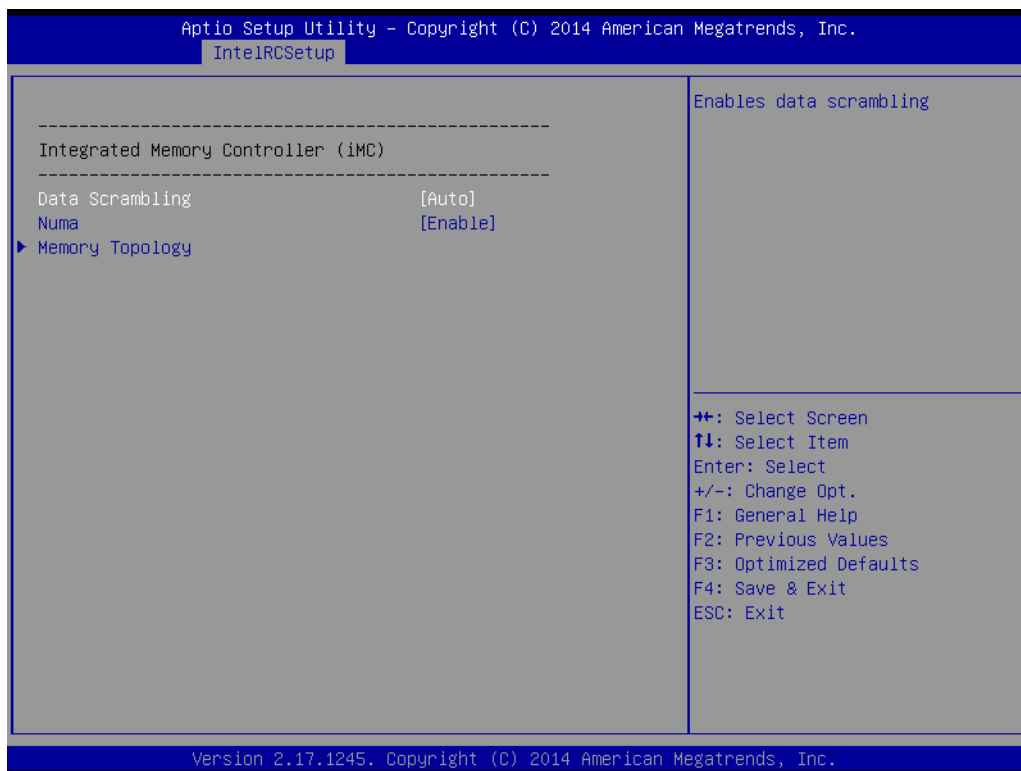

- **Data Scrambling**
Enable/Disable Data Scrambling.
- **Numa**
Enable/Disable non uniform memory access (NUMA).
- **Memory Technology**
Display memory topology with DIMM population information.

3.2.3.5 I/O Configuration



- **CPU0/CPU1 PCIe Configuration**
PCIe port bifurcation control and select target link speed as Gen1, Gen2, Gen3.
- **PCI-E ASPM Support**
This item is to set the ASPM level. [Auto]: BIOS auto configure; [Force L0s]: Force all links to L0s state; [Disable]: To disable ASPM. Extended Synch If this item is [Enable], it allows generation of extended synchronization patterns.
- **VGA Priority**
Determines priority between onboard and 1st off-board video device found.

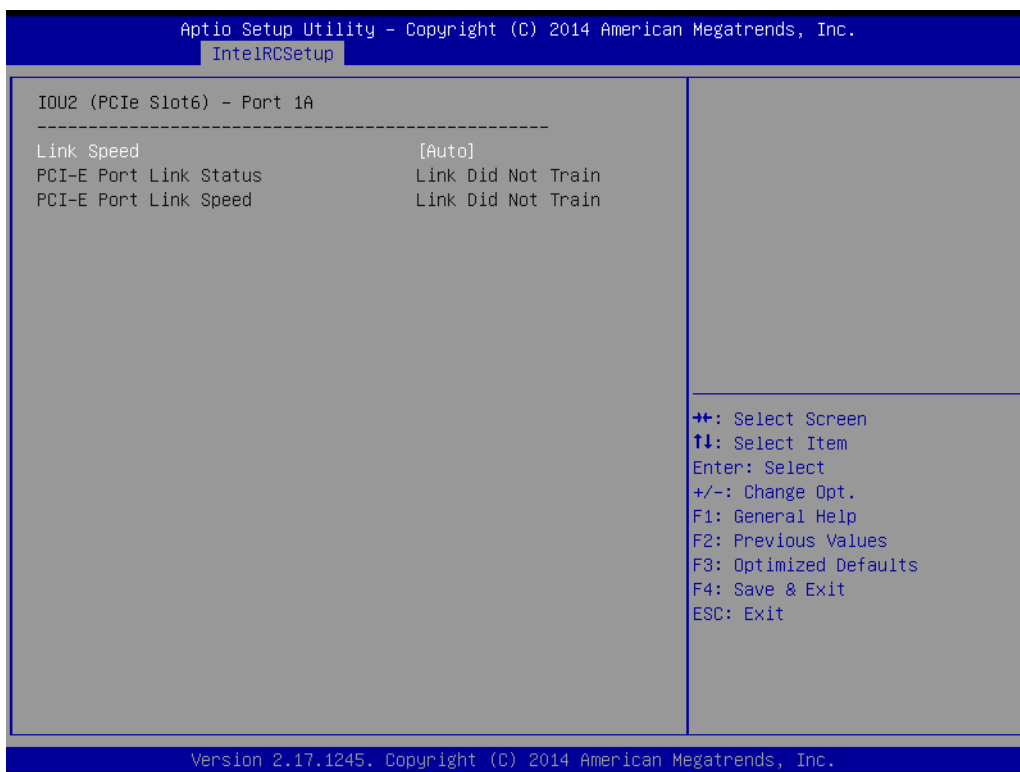
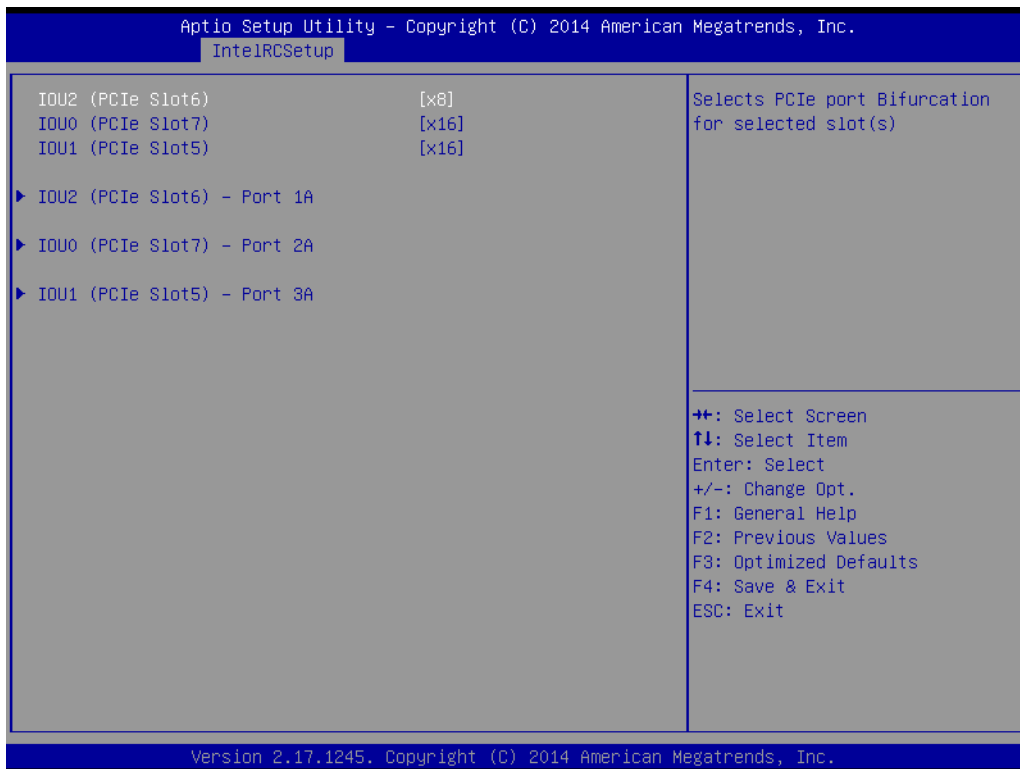

3.2.3.6 PCH Configuration

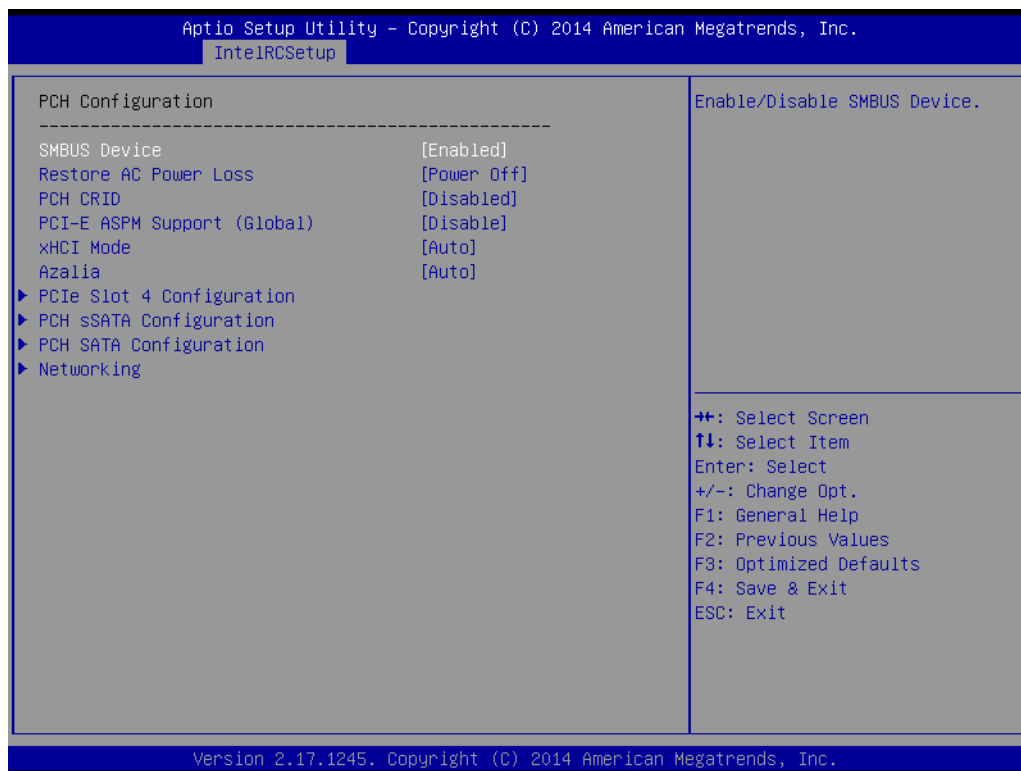

- **SMBus Controller**
Enable/Disable SMBus controller.
- **Restore AC Power Loss**
Specify what state to go to when power is re-applied after a power failure (G3 state).
- **PCH Compatibility RID**
Enable/Disable PCH Compatibility Revision ID (CRID) Functionality.
- **PCI-E ASPM Support**
To set ASPM level for PCI Express.
- **XHCI Mode**
Mode of operation of XHCI controller.
- **Azalia HD Audio**
Enable/Disable Azalia HD audio function.
- **PCIe Slot 4 Configuration**
To enable or disable PCI Express Slot 4 and select target link speed as Gen1, Gen2.

■ PCH SATA and sSATA Configuration

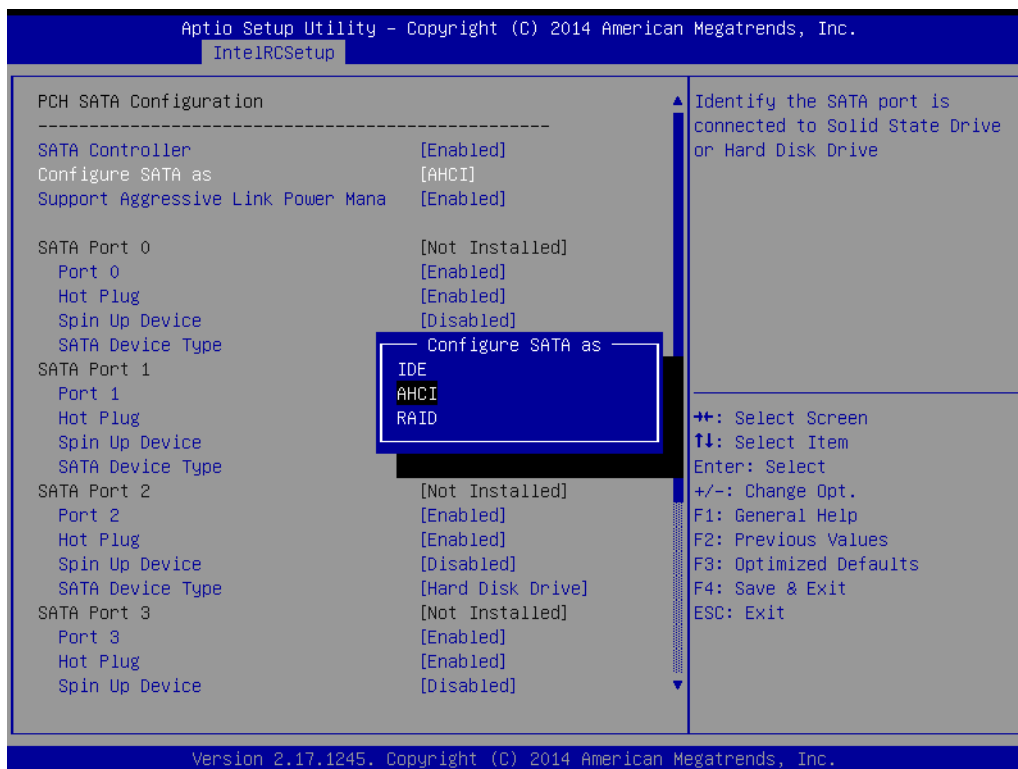
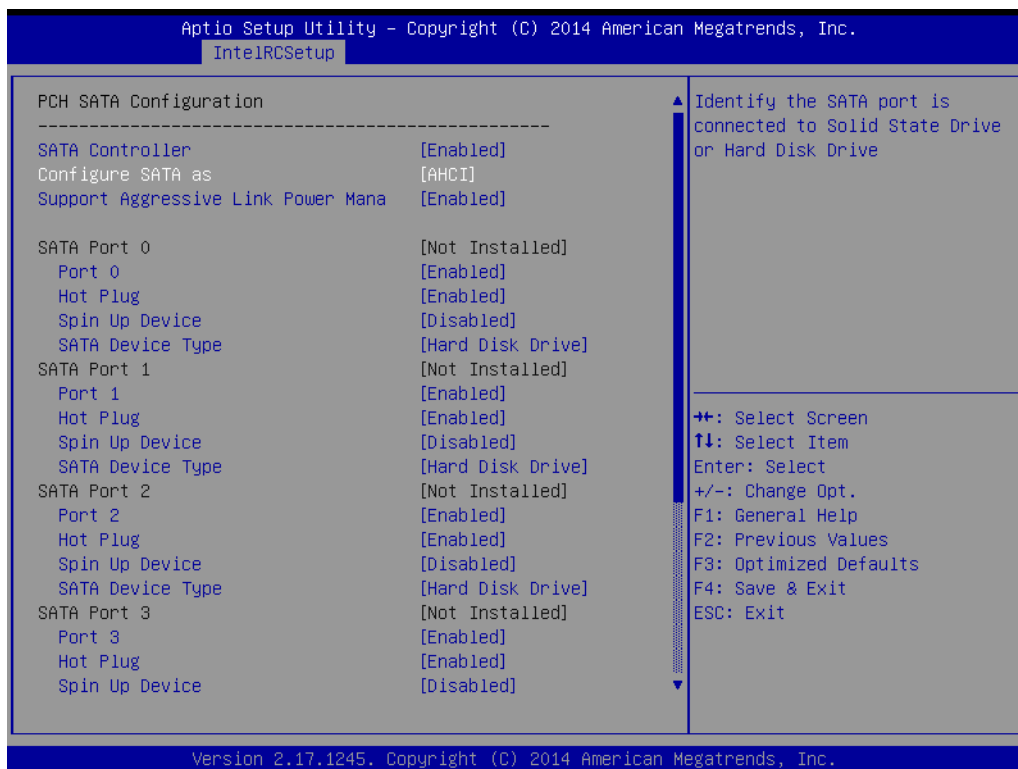

- **SATA Controller(s)**
This item is to enable or disable SATA devices.
- **Configure SATA Mode**
Set as IDE, AHCI, or RAID when SATA Controllers are enabled.

- **Support Aggressive Link Power Management**
Enable or disable Aggressive Link Power Management (ALPM) protocol for Advanced Host Controller Interface-compliant (AHCI) Serial ATA (SATA) devices.
- **SATA Port 0~5 and sSATA Port 0~3**
To enable or disable SATA port 0~5.
- **SATA Port 0~5 and sSATA Port 0~3 Spin Up Device**
On an edge detect from 0 to 1, the PCH starts a COMRESET initialization sequence to the device.
- **SATA Port 0~5 and sSATA Port 0~3 Device Type**
To identify the SATA is connected to Solid State Drive or Hard Disk Drive.

■ **Networking**

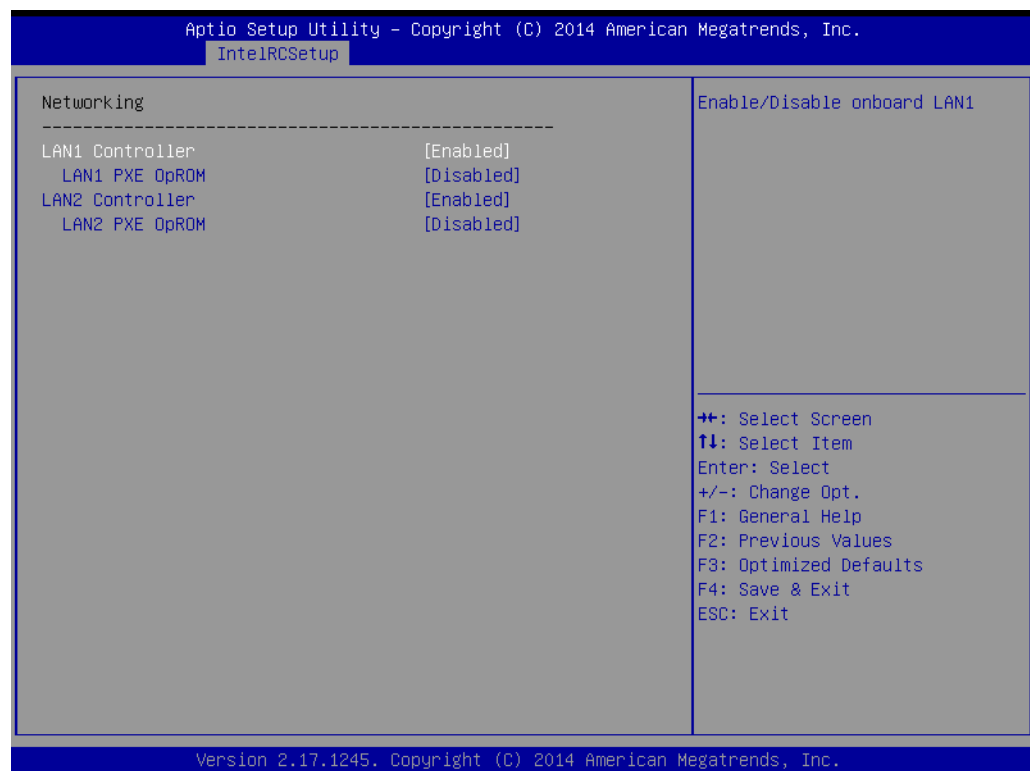

- **LAN1 Controller**
Enable/Disable Intel I210 Controller support.
- **LAN1 PXE OpROM**
Enable/Disable Boot option for Intel I210 controller.
- **LAN2 Controller**
Enable/Disable Intel I210 Controller support.
- **LAN2 PXE OpROM**
Enable/Disable Boot option for Intel I210 controller.

3.2.3.7 Server ME Configuration

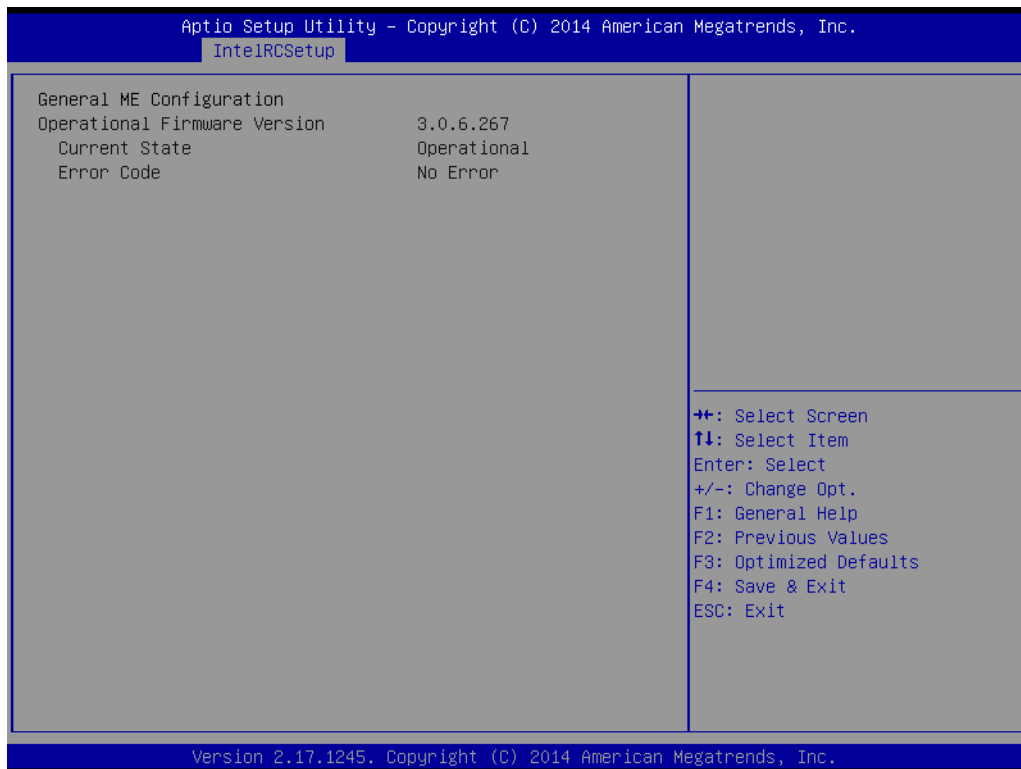

This page shows the Server ME configuration

3.2.4 Server Management

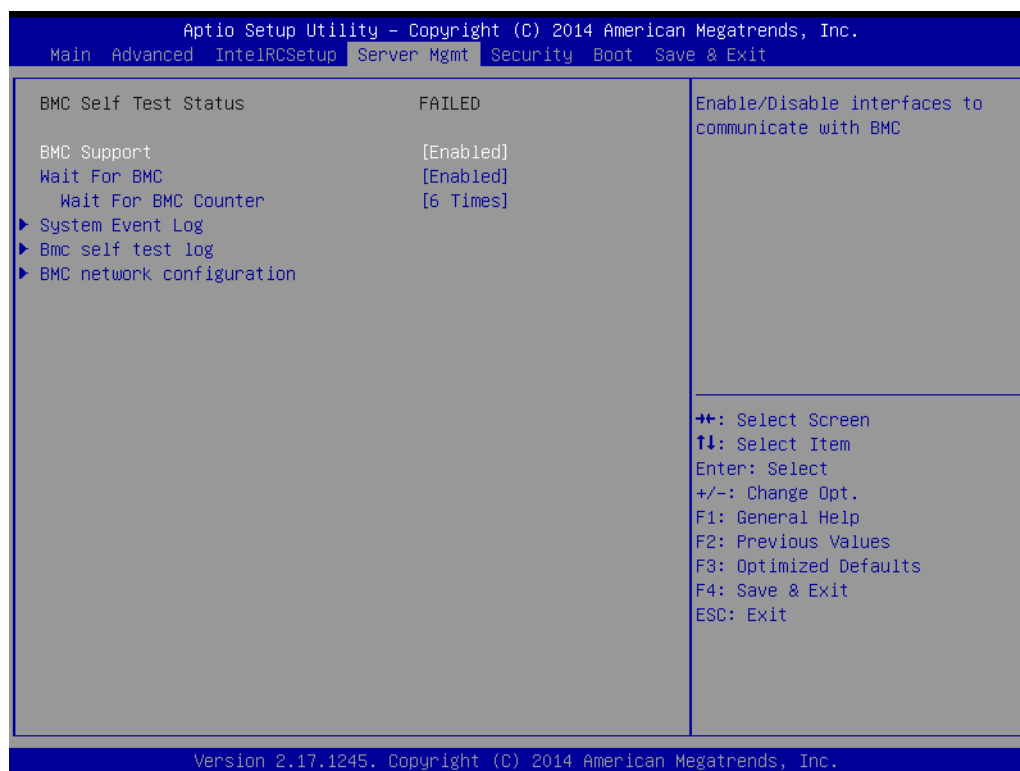

- **BMC Support**
Enable/Disable interfaces to communicate with BMC
- **Wait for BMC**
If enabled, motherboard will wait 30 ~ 60 seconds until BMC module boots up completely. After that, the normal BIOS post screen will be displayed.
If disabled, motherboard will not wait for BMC module's response.
- **Wait for BMC counter**
Wait for BMC counter for initialize host to BMC interfaces.
The MB beep per 5 seconds to check it.

3.2.4.1 System Event Log

- **SEL Components**
Enable/Disable all features of system event logging during boot.
- **Erase SEL**
Choose options for erasing SEL.
- **When SEL is Full**
Choose options for reactions to a full SEL.
- **Log EFI Status Codes**
Disable the logging of EFI status codes or log only error code or only progress code or both.

3.2.4.2 BMC Self Test Log

- **Erase Log**
Erase log options.
- **When Log is Full**
Select the action to be taken when log is full.

3.2.4.3 BMC Network Configuration

■ Configuration Address Source

Select to configure LAN channel parameters statically or dynamically (by BMC). Unspecified option will not modify any BMC network parameters during BIOS phase.

3.2.5 Security

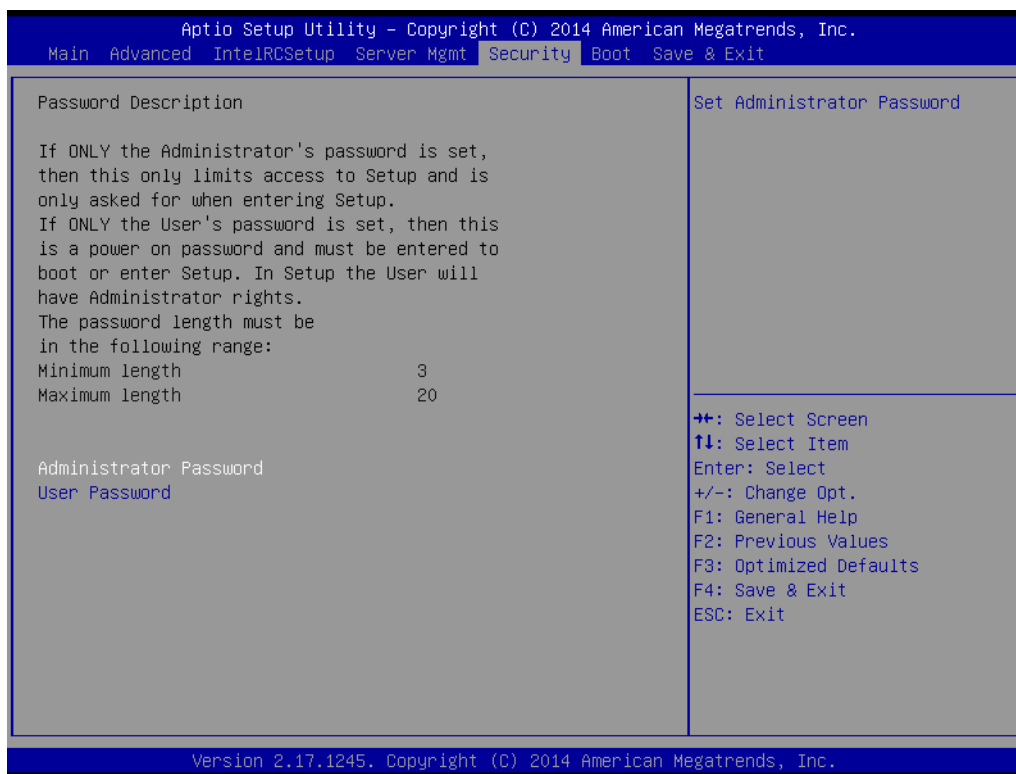

Note! *With AC power & Battery. Short CMOS1 Jumper:*



Date/Time & Password: Keep

Setting: reset to default

AC power and CMOS battery are removed. Short CMOS1 Jumper:

Date/Time: reset to default

Password: Keep

Setting: reset to default

3.2.6 Boot

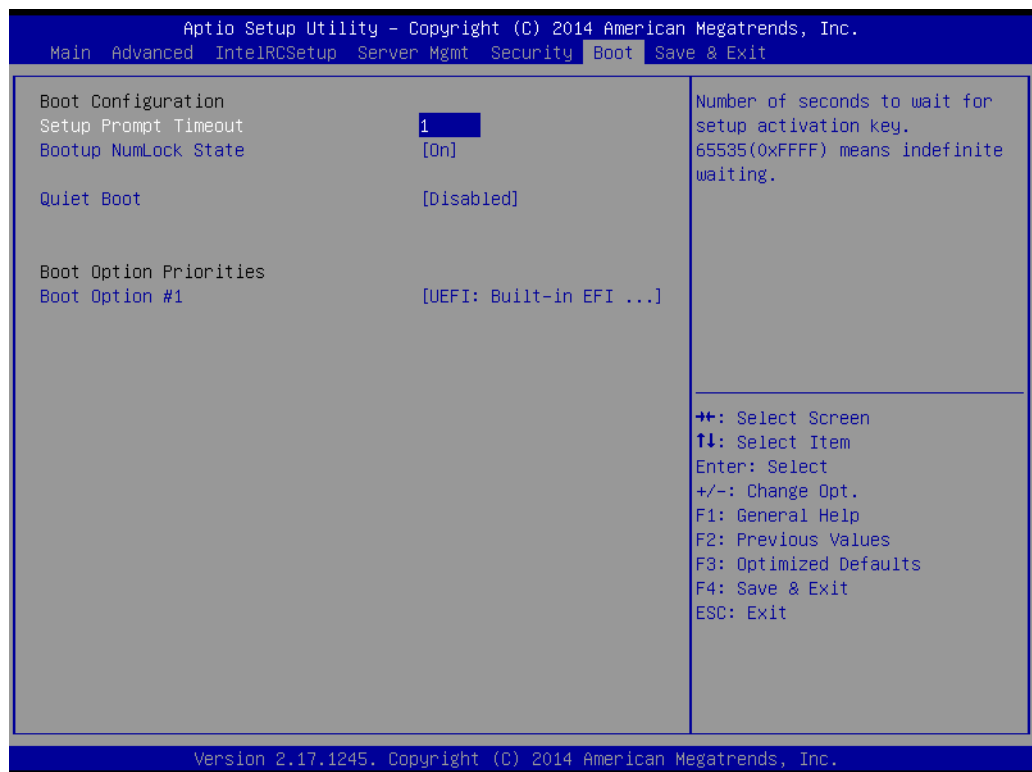

- **Setup Prompt Timeout**
Number of seconds to wait for setup activation key. 16 (0x10) means indefinite waiting.
- **Bootup NumLock State**
Select the keyboard NumLock state.
- **Quiet Boot**
Enable/Disable quiet boot option.
- **Boot Option Priorities**
Sets the system boot priorities.

3.2.7 Save & Exit



- **Save Changes and Exit**
Exit system setup after saving the changes.
- **Discard Changes and Exit**
Exit system setup without saving any changes.
- **Save Changes and Reset**
Reset the system after saving changes.
- **Discard Changes and Reset**
Reset system setup without saving any changes.
- **Save Changes**
Save changes done so far to any of the setup options.
- **Discard Changes**
Discard changes done so far to any of the setup options.
- **Restore Defaults**
Restore/Load default values for all the setup options.
- **Save as User Defaults**
Save the changes done so far as user defaults.
- **Restore User Defaults**
Restore the user defaults to all the setup options.

Chapter 4

Chipset Software
Installation Utility

4.1 Before Beginning

To facilitate the installation of the enhanced display drivers and utility software, read the instructions in this chapter carefully. The drivers for the ASMB-923I are located on the software installation CD.

Before beginning, it is important to note that most display drivers need to have the relevant software application already installed on the system prior to installing the enhanced display drivers. In addition, many of the installation procedures assume that you are familiar with both the relevant software applications and operating system commands. Review the relevant operating system commands and the pertinent sections of your application software's user manual before performing the installation.

4.2 Introduction

4.2.1 Main Menu

The Intel Chipset Software Installation (CSI) utility installs the Windows INF files that outline to the operating system how the chipset components will be configured. This is needed for the proper functioning of the following features:

- Core PCI PnP services
- Serial ATA interface support
- USB 1.1/2.0 support (USB 2.0 driver needs to be installed separately for Windows 98)
- Identification of Intel chipset components in the Device Manager

Note! *The files on the software installation CD are compressed. Do not attempt to install the drivers by copying the files manually. You must use the supplied SETUP program to install the drivers.*



Note! *The chipset driver is used for the following versions of Windows, and it has to be installed before installing all the other drivers:*



<i>Windows Server 2012 R2 Standard</i>	<i>x64</i>
<i>Windows Server 2008 Enterprise Edition R2(SP1)</i>	<i>x64</i>
<i>Windows 7(Ultimate SP1)</i>	<i>x86 & x64</i>
<i>Windows 8.1 Ultimate</i>	<i>x86 & x64</i>

Note! *It is necessary to update all the latest Microsoft hot fix files when using this OS.*



4.3 Windows 7 & 8/ Windows server 2008 & 2012

1. Insert the driver CD into your system's CD-ROM drive. When the folder is displayed, move the mouse cursor over the folder "01_Intel INF". Find the executable in this folder, click to install the driver.

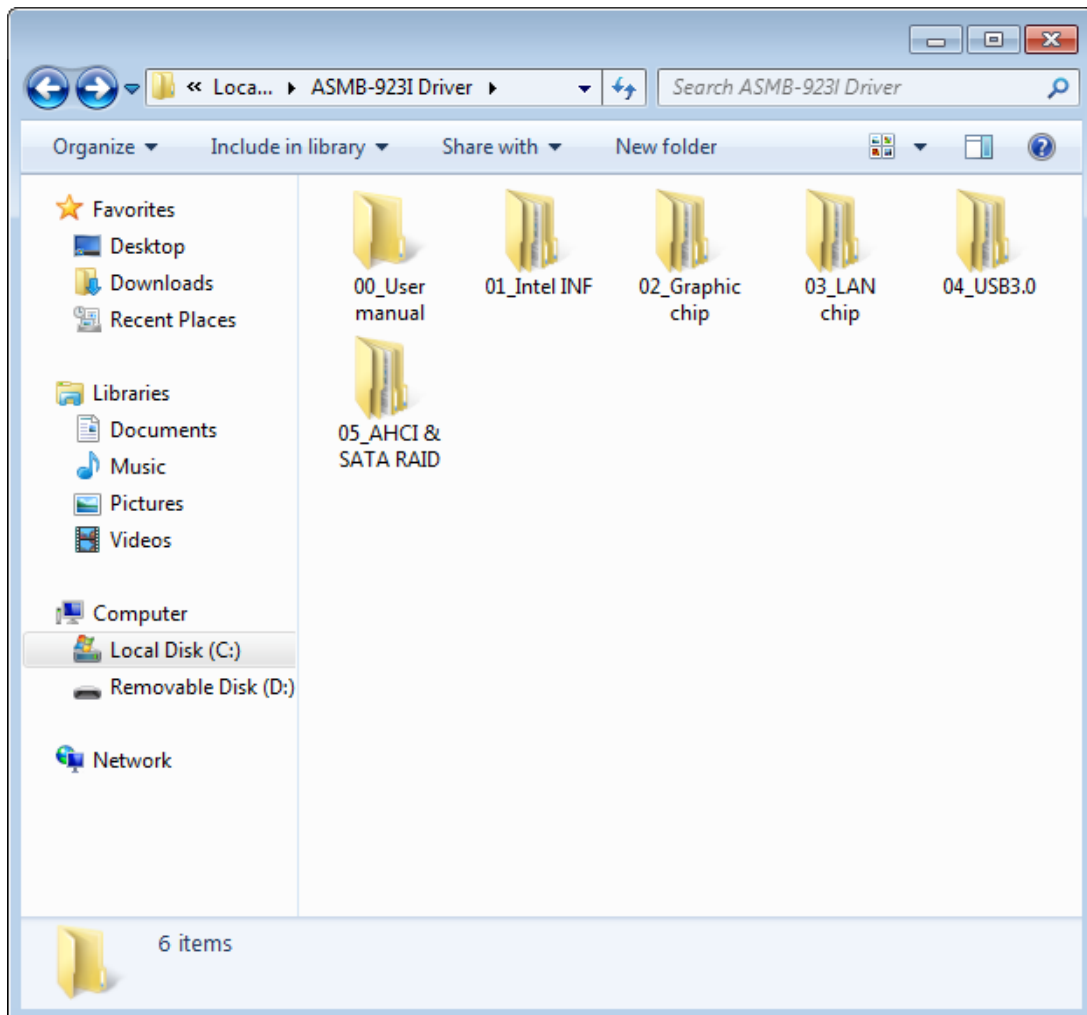

2. Click setup to execute program.

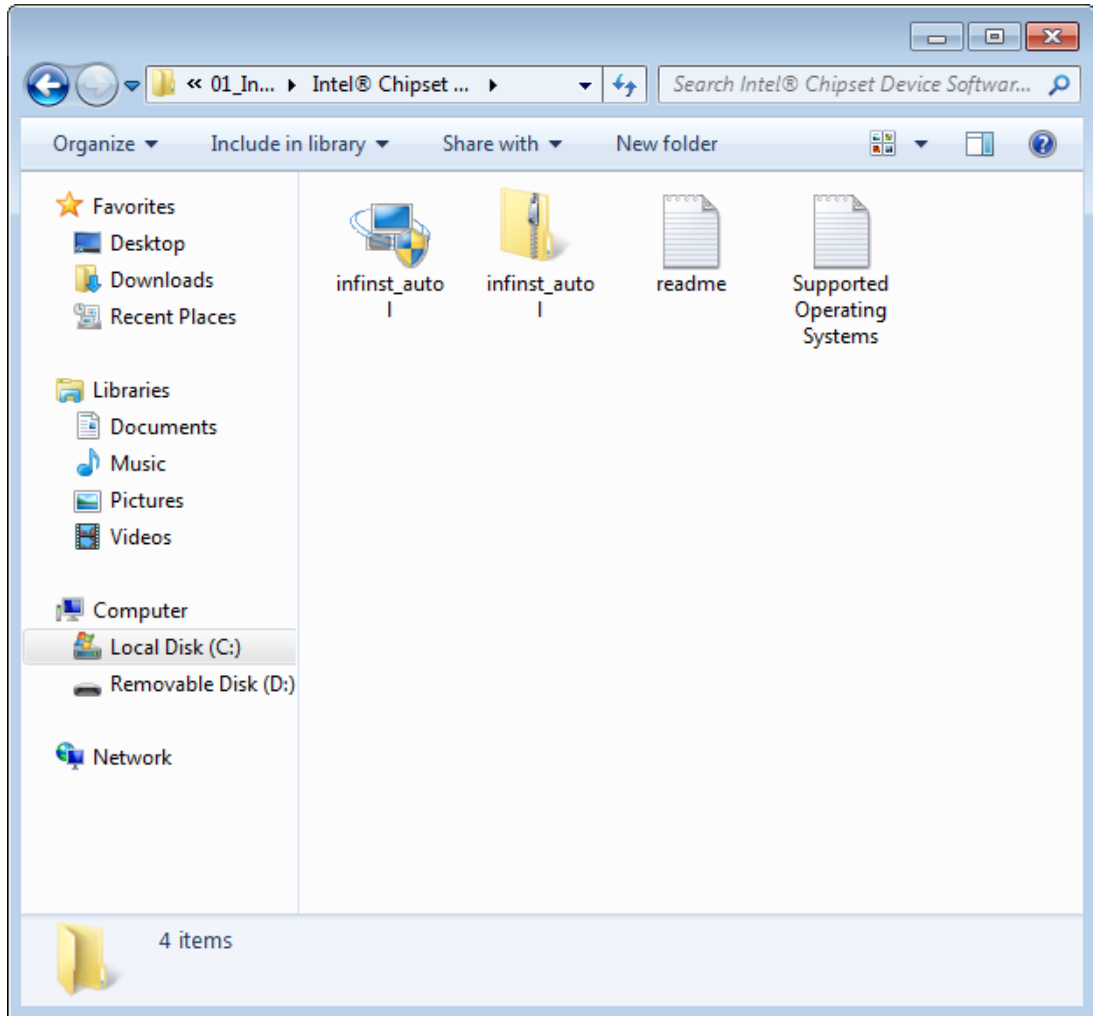

Chapter 5

VGA Setup

5.1 Introduction

Install the ASPEED VGA driver to enable this function, which includes the following features:

- 32-bit 2D graphics engine on board for normal use.
- 64 MB RAM for this chip, the highest resolution is 1920x1200.

5.2 Windows Series Driver Setup

Insert the driver CD into your system's CD-ROM drive. When the folder is displayed, navigate to the "02_Graphic chip" folder and click the executable file to complete the installation of the drivers for the OS that you need.

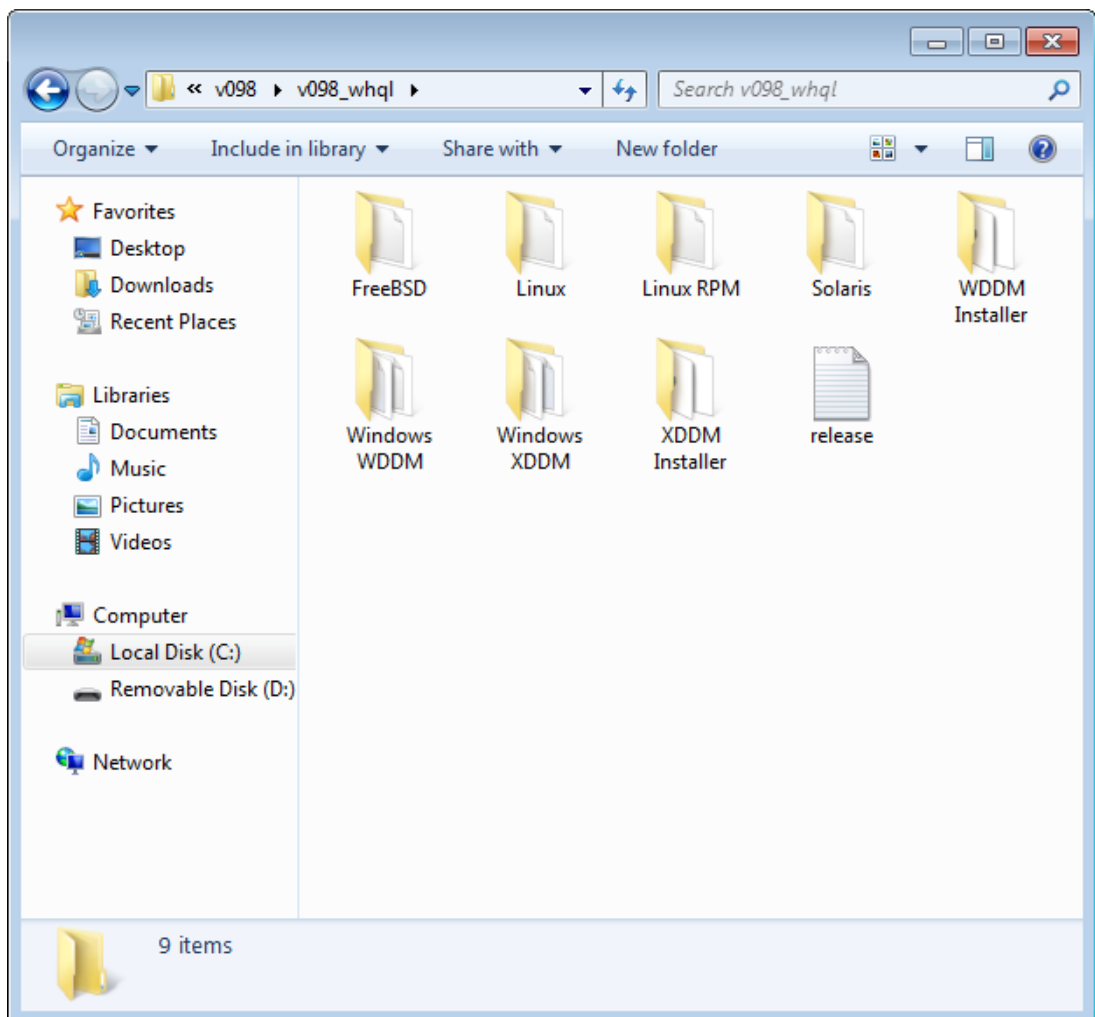

Note!

1. *If ASMB-923I carries an additional graphics card for VGA output, please set this additional graphic card as "major output" under the "Display properties" of OS.*
2. *Please use the driver file from "Windows WDDM" folder as first choice.*
3. XDDM and WDDM Driver Selection for Win7/Vista/2008/2008R2 OS.
 - In general, we strongly recommend our customers to use XDDM driver, not WDDM driver. ASPEED's WDDM driver is only for the motherboard which supports multi-adapters function. Multi-adapter function means the mother board has 2 different VGA chips (or add-on cards) on-board, one is the 3rd party VGA chip, another is ASPEED VGA chip, and the 3rd party VGA chip only provides WDDM driver.
4. ASPEED Graphics WDDM Driver Limitation on Vista/Windows7/Server2008/Server2008R2
 - It is non-WHQL certified driver because ASPEED VGA is a 2D VGA, it cannot meet the WHQL requirement of WDDM driver which requires 3D VGA function.
 - Because it is non-WHQL certified driver, it may meet some compatible issues with some specific applications
5. ASPEED Graphics WDDM Driver Limitation on Windows 8/2012:
 - Not support the modes with different display frequency

Chapter 6

LAN Configuration &
USB 3.0

6.1 LAN Configuration

6.1.1 Introduction

The ASMB-923I has two Gigabit Ethernet LAN connections via dedicated PCI Express x1 lanes: GbE LAN1 - Intel I210; GbE LAN2 - I210. They offer bandwidth of up to 500 MB/sec, eliminating the bottleneck of network data flow and incorporating Gigabit Ethernet at 1000 Mbps.

6.1.2 Features

- 10/100/1000Base-T Ethernet controller
- 10/100/1000Base-T triple-speed MAC
- Full duplex at 10, 100, or 1000 Mbps and half duplex at 10 or 100 Mbps
- Wake-on-LAN (WOL) support
- PCIe x1 host interface

6.1.3 Installation

The integrated Intel gigabit Ethernet controller supports all major network operating systems. However, the installation procedure varies with different operating systems. In the following sections, refer to the one that provides the driver setup procedure for the operating system you are using.

6.1.4 Windows Series Driver Setup (LAN)

1. Insert the driver CD into your system's CD-ROM drive. Select folder "03_Lan chip" then click the proper Lan driver for the OS.

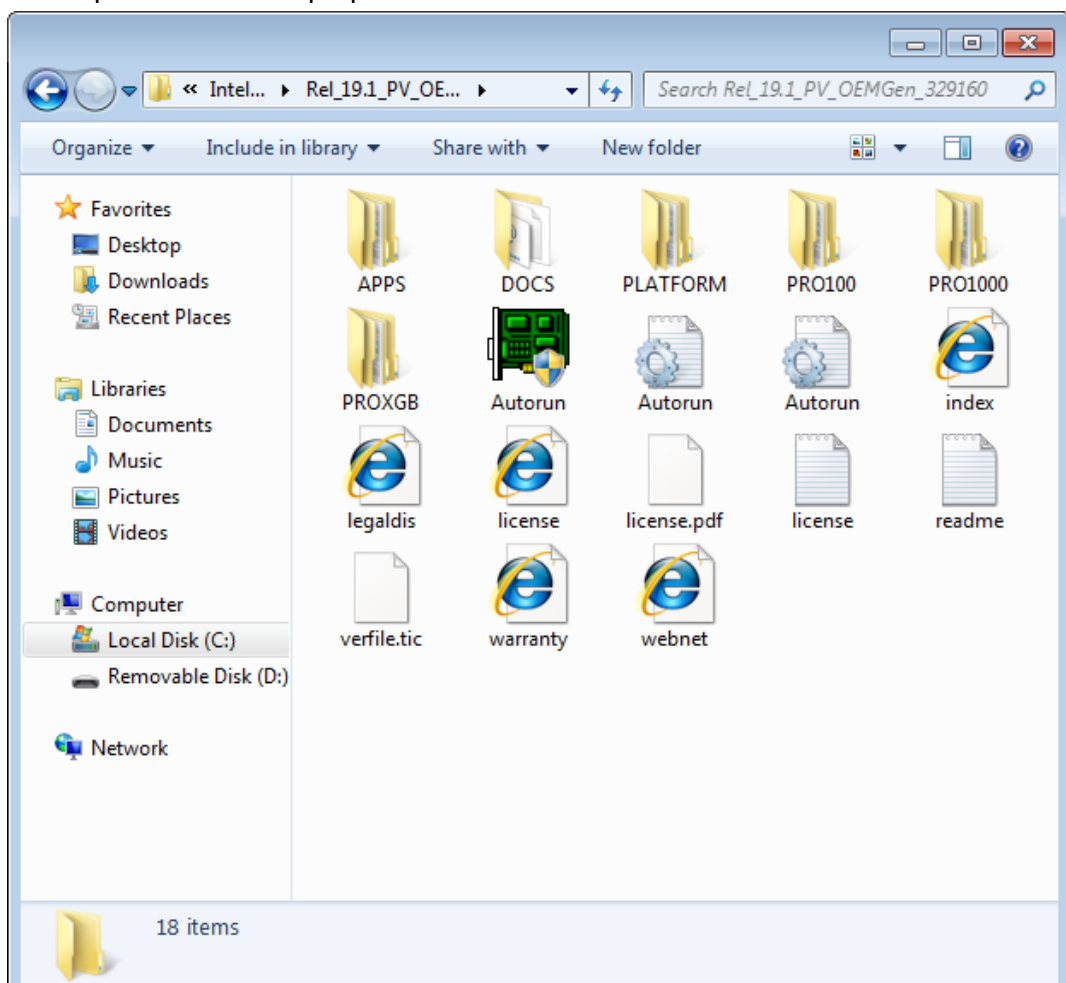

6.2 USB 3.0

6.2.1 Introduction

ASMB-923I offers two USB 3.0 ports in rear side. The USB 3.0 could provide the bandwidth up to 500MB/s to shorter the time for data transmission.

6.2.2 Windows Series Driver Setup

Insert the driver CD into your system's CD-ROM drive. Select folder "04_USB3.0 chip" then click the proper ".exe" driver file for the installation.

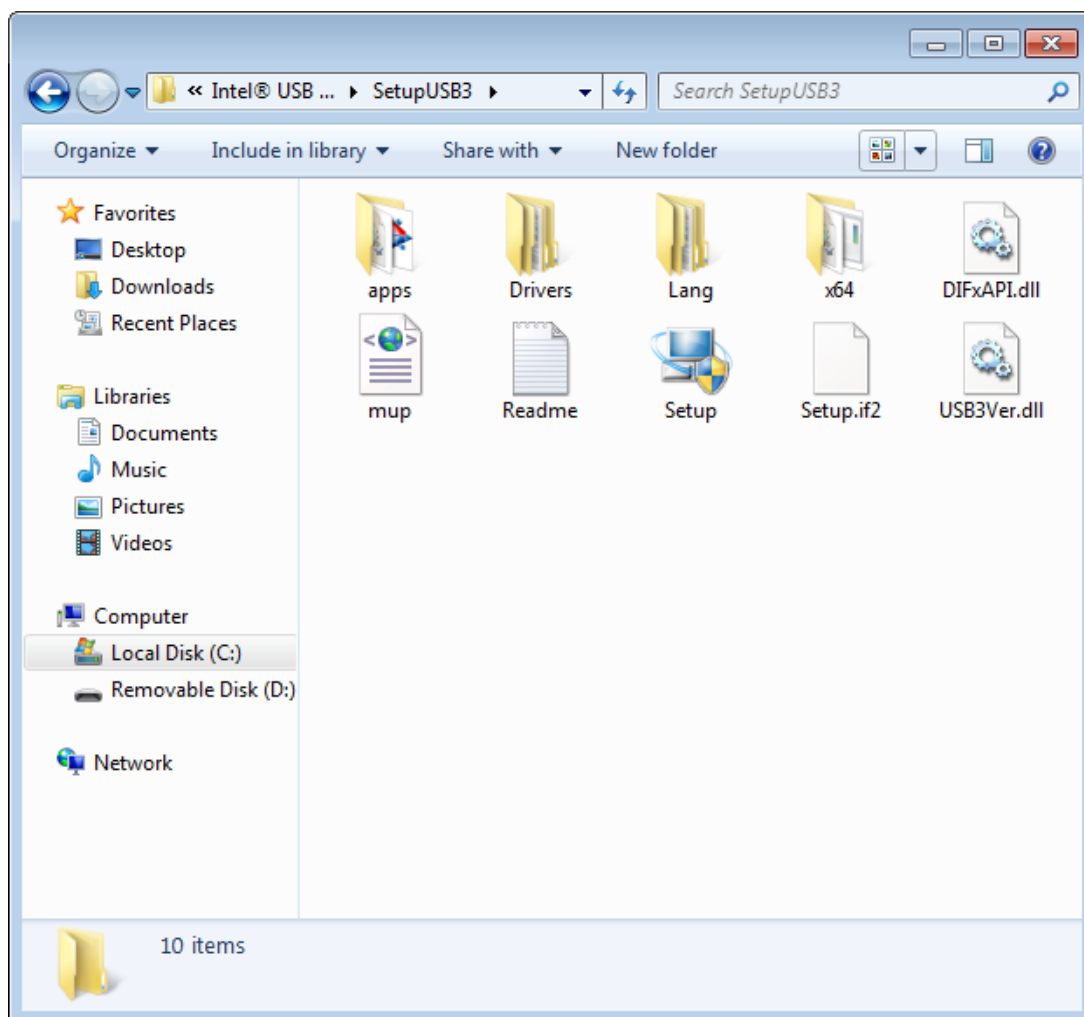

6.3 AHCI & SATA RAID

Intel C612 PCH chip offers SATA RAID with RAID 0, 1, 10, 5 under Windows operating system.

But there are some limitation & remarks shown as below:

OS	AHCI	RAID	Remark
Windows 7 32/64 bit	Support	Support	-
Windows server 2008 32/64bit	Support	Support	-
Windows 8 32/64 bit	Support	Support	-
Windows server 2012 32/64bit	Support	Support	-

Note!  1. Please visit the Intel download center for "Intel Rapid Storage Technology enterprise for Microsoft Windows Operating System Software User's Guide" file download,

The download address is:

http://download.intel.com/support/motherboards/server/sb/g40440_005_rste_swug_r1_5.pdf

2. For the hotfix file download, please visit:

<http://support.microsoft.com/kb/932755/en-us>

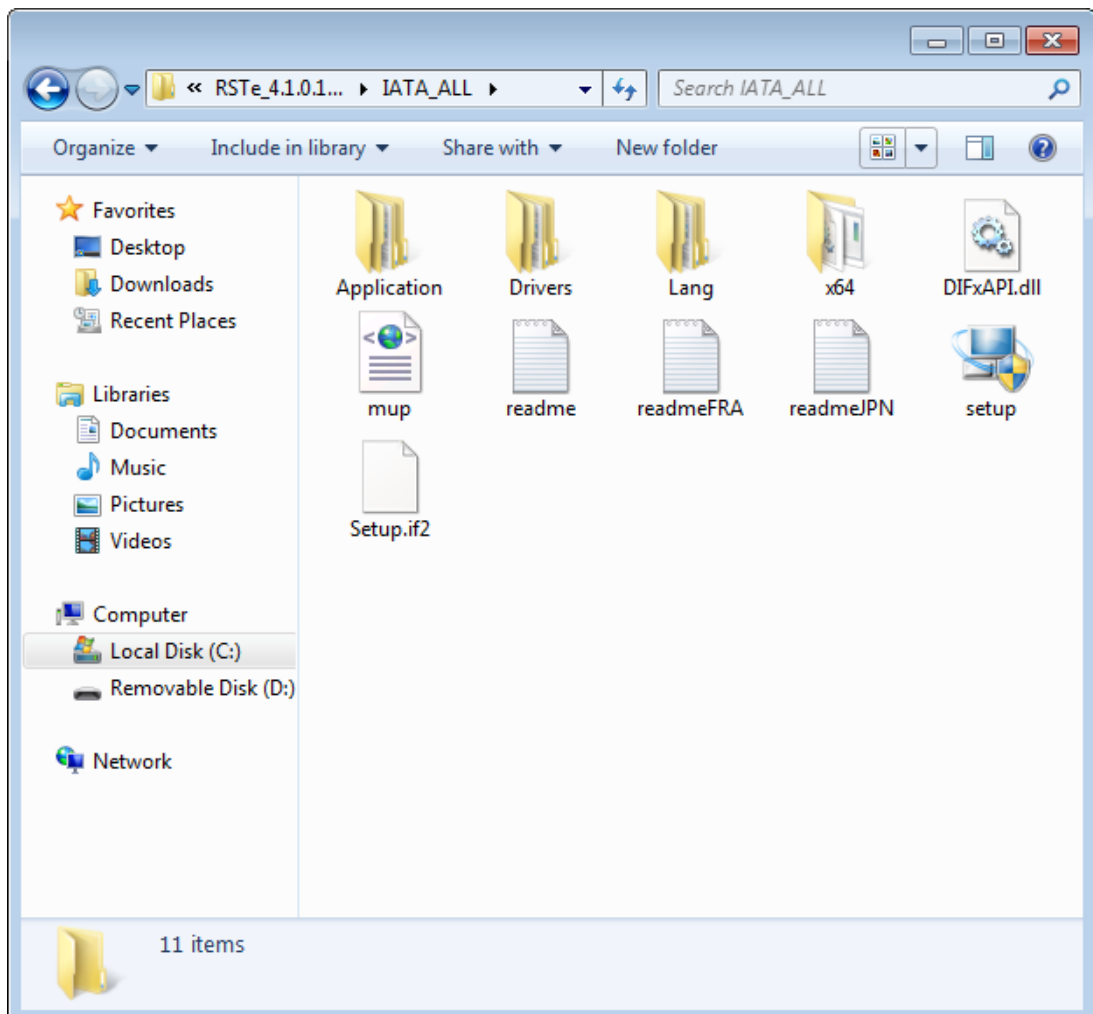

Appendix **A**

Programming the
Watchdog Timer

The ASMB-923I's watchdog timer can be used to monitor system software operation and take corrective action if the software fails to function within the programmed period. This section describes the operation of the watchdog timer and how to program it.

A.1 Watchdog Timer Overview

The watchdog timer is built in to the super I/O controller NCT6776D. It provides the following functions for user programming:

- Can be enabled and disabled by user program
- Timer can be set from 1 to 255 seconds or 1 to 255 minutes
- Generates an interrupt or resets signal if the software fails to reset the timer before time-out

A.2 Programming the Watchdog Timer

The I/O port address of the watchdog timer is 2E (hex) and 2F (hex). 2E (hex) is the address port. 2F (hex) is the data port. You must first write an address value into address port 2E (hex), and then write/read data to/from the assigned register through data port 2F (hex).

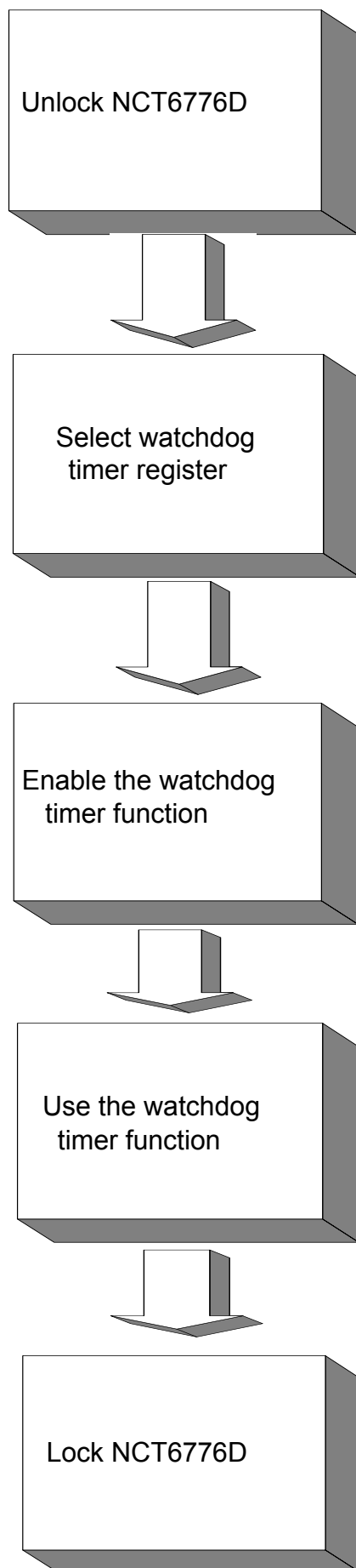

Table A.1: Watchdog Timer Registers

Address of register (2E)	Read/Write	Value (2F) & description
87 (hex)	-	Write this address to I/O address port 2E (hex) twice to unlock the NCT6776D
07 (hex)	write	Write 08 (hex) to select register of watchdog timer.
30 (hex)	write	Write 01 (hex) to enable the function of the watchdog timer. Disabled is set as default.
F5 (hex)	write	Set seconds or minutes as units for the timer. Write 0 to bit 3: set seconds as counting unit. [default]. Write 1 to bit 3: set minutes as counting unit. Write 1 to bit 4: Watchdog timer count mode is 1000 times faster. If bit 3 is 0, the count mode is 1/1000 seconds mode. If bit 3 is 1, the count mode is 1/1000 minutes mode.
F6 (hex)	write	0: stop timer [default] 01 ~ FF (hex): The amount of the count, in seconds or minutes, depends on the value set in register F5 (hex). This number decides how long the watchdog timer waits for strobe before generating an interrupt or reset signal. Writing a new value to this register can reset the timer to count with the new value.
F7 (hex)	read/write	Bit 6: Write 1 to enable keyboard to reset the timer, 0 to disable. [default] Bit 5: Write 1 to generate a timeout signal immediately and automatically return to 0. [default=0] Bit 4: Read status of watchdog timer, 1 means timer is "timeout".
AA (hex)	-	Write this address to I/O port 2E (hex) to lock NCT6776F.

A.2.1 Example Programs

Enable watchdog timer and set 10 seconds as the timeout interval

```

;-----
Mov dx,2eh ; Unlock NCT6776D
Mov al,87h
Out dx,al
Out dx,al
;-----
Mov al,07h ; Select registers of watchdog timer
Out dx,al
Inc dx
in al,dx
Or al,08h
Out dx,al
;-----
Dec dx; Enable the function of watchdog timer
Mov al,30h
Out dx,al
Inc dx
Mov al,01h
Out dx,al
;-----

```

```

Dec dx ; Set second as counting unit
Mov al,0f5h
Out dx,al
Inc dx
In al,dx
And al,not 08h
Out dx,al
;-----
Dec dx ; Set timeout interval as 10 seconds and start counting
Mov al,0f6h
Out dx,al
Inc dx
Mov al,10; 10 minutes
Out dx,al
;-----
Dec dx ; lock NCT6776D
Mov al,0aah
Out dx,al
Enable watchdog timer and set 5 minutes as the timeout interval
;-----
Mov dx,2eh ; unlock NCT6776D
Mov al,87h
Out dx,al
Out dx,al
;-----
Mov al,07h ; Select registers of watchdog timer
Out dx,al
Inc dx
In al,dx
Or al,08h
Out dx,al
;-----
Dec dx ; Enable the function of watchdog timer
Mov al,30h
Out dx,al
Inc dx
Mov al,01h
Out dx,al
;-----
Dec dx ; Set minute as counting unit
Mov al,0f5h
Out dx, al
Inc dx
In al,dx
Or al, 08h

```

```

Out dx,al
;-----
Dec dx ; Set timeout interval as 5 minutes and start counting
Mov al,0f6h
Out dx,al
Inc dx
Mov al,5; 5 minutes
Out dx,al
;-----
Dec dx ; lock NCT6776D
Mov al,0aah
Out dx,al
Enable watchdog timer to be reset by mouse
;-----
Mov dx,2eh ; unlock NCT6776D
Mov al,87h
Out dx,al
Out dx,al
;-----
Mov al,07h ; Select registers of watchdog timer
Out dx,al
Inc dx
Mov al,08h
Out dx,al
;-----
Dec dx ; Enable the function of watchdog timer
Mov al,30h
Out dx,al
Inc dx
In al,dx
Or al,01h
Out dx,al
;-----
Dec dx ; Enable watchdog timer to be reset by mouse
Mov al,0f7h
Out dx,al
Inc dx
In al,dx
Or al,80h
Out dx,al
;-----
Dec dx ; lock NCT6776D
Mov al,0aah
Out dx,al
Enable watchdog timer to be reset by keyboard

```

```

;-----
Mov dx,2eh ; unlock NCT6776D
Mov al,87h
Out dx,al
Out dx,al
;-----
Mov al,07h ; Select registers of watchdog timer
Out dx,al
Inc dx
Mov al,08h
Out dx,al
;-----
Dec dx ; Enable the function of watchdog timer
Mov al,30h
Out dx,al
Inc dx
Mov al,01h
Out dx,al
;-----
Dec dx ; Enable watchdog timer to be strobed reset by keyboard
Mov al,0f7h
Out dx,al
Inc dx
In al,dx
Or al,40h
Out dx,al
;-----
Dec dx ; lock NCT6776D
Mov al,0aah
Out dx,al
Generate a time-out signal without timer counting
;-----
Mov dx,2eh ; unlock NCT6776D
Mov al,87h
Out dx,al
Out dx,al
;-----
Mov al,07h ; Select registers of watchdog timer
Out dx,al
Inc dx
Mov al,08h
Out dx,al
;-----
Dec dx ; Enable the function of watchdog timer
Mov al,30h

```

```
Out dx,al
Inc dx
In al,dx
Or al,01h
Out dx,al
;-----
Dec dx ; Generate a time-out signal
Mov al,0f7h
Out dx,al ;Write 1 to bit 5 of F7 register
Inc dx
In al,dx
Or al,20h
Out dx,al
;-----
Dec dx ; lock NCT6776D
Mov al,0aah
Out dx,al
```

Appendix **B**

I/O Pin Assignments

B.1 USB Header (USB67/89)

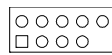

USB67

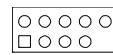

USB89

Table B.1: USB Header (USB67,USB89)

Pin	Signal	Pin	Signal
1	USB_VCC5	2	USB_VCC5
3	USB_D-	4	USB_D-
5	USB_D+	6	USB_D+
7	GND	8	GND
9	Key	10	N/C

B.2 USB3.0 Header(USB2_3)

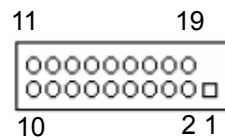

Table B.2: USB Header (USB23,USB45,USB67,USB89)

Pin	Signal	Pin	Signal
1	+5 V	2	STDA_SSRX-
3	STDA_SSRX+	4	GND
5	STDA_SSRX-	6	STDA_SSRX+
7	GND	8	D-
9	D+	10	OC#
11	D+	12	D-
13	GND	14	STDA_SSRX+
15	STDA_SSRX-	16	GND
17	STDA_SSRX+	18	STDA_SSRX-
19	+5 V	20	

B.3 VGA Connector (VGA1)

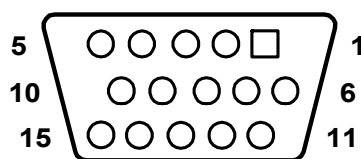

Table B.3: VGA Connector (VGA1)

Pin	Signal	Pin	Signal
1	RED	9	VCC
2	GREEN	10	GND
3	BLUE	11	N/C
4	N/C	12	SDT
5	GND	13	H-SYNC
6	GND	14	V-SYNC
7	GND	15	SCK
8	GND		

B.4 RS-232 Interface (COM2)

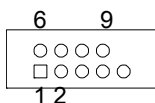

Table B.4: RS-232 Interface (COM2)

Pin	Signal
1	DCD
2	RXD
3	TXD
4	DTR
5	GND
6	DSR
7	RTS
8	CTS
9	RI

B.5 PS/2 Keyboard and Mouse Connector (KBMS1)

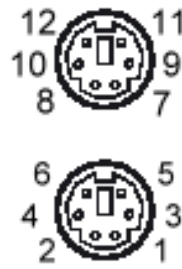

Table B.5: Keyboard and Mouse Connector (KBMS1)

Pin	Signal
1	KB DATA
2	N/C
3	GND
4	KB VCC
5	KB CLK
6	N/C
7	M_DATA
8	N/C
9	GND
10	M_VCC
11	M_CLK
12	N/C

B.6 External Keyboard Connector (KBMS2)

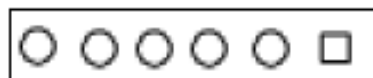

Table B.6: External Keyboard Connector (KBMS2)

Pin	Signal
1	KB CLK
2	KB DATA
3	MS DATA
4	GND
5	VCC
6	MS CLK

B.7 System Fan Power Connector (SYSFAN0~2)

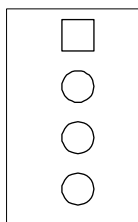

Table B.7: Fan Power Connector (SYSFAN0/SYSFAN1/SYSFAN2)

Pin	Signal
1	GND
2	+12 V
3	DETECT
4	PWM

B.8 Power LED (JFP3)

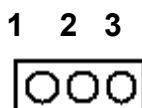

Table B.8: Power LED (JFP1)

Pin	Function
1	LED power (3.3 V)
2	NC
3	Ground

B.9 External Speaker Connector (JFP2)

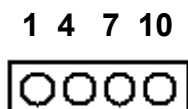

Table B.9: External Speaker Connector (JFP2)

Pin	Function
1	SPK+
4	NC
7	BZ-
10	SPK-

B.10 Reset Connector (JFP1)

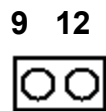

Table B.10: Reset Connector (JFP1)

Pin	Signal
9	RESET
12	GND

B.11 HDD LED Connector (JFP1)

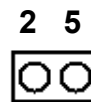

Table B.11: HDD LED Connector (JFP1)

Pin	Signal
2	HDD_LED+
5	HDD_LED-

B.12 ATX Soft Power Switch (JFP1)



Table B.12: ATX Soft Power Switch (JFP1)

Pin	Signal
3	PWR-BTN
6	GND

B.13 Front panel SMBus Connector (SMBUS1)

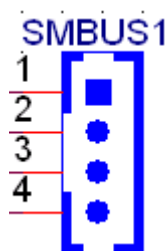

1	+3.3V_AUX
2	SMB_SCL_FRU
3	SMB_SDA_FRU
4	GND

B.14 USB/LAN Ports (LAN1_USB01 and LAN2_USB23)

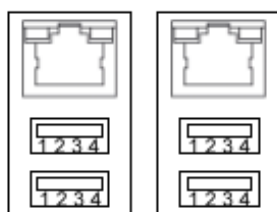

LAN1_USB01 LAN2_USB23

Table B.13: USB Port

Pin	Signal	Pin	Signal
1	VCC_DUAL	3	Data0+
2	Data0-	4	GND

Table B.14: Giga LAN 10/100/1000 Base-T RJ-45 Port

Pin	Signal	Pin	Signal
1	MID0+	5	MID2+
2	MID0-	6	MID2+
3	MID1+	7	MID3+
4	MID1-	8	MID3+

B.15 Audio Connector (AUDIO1)

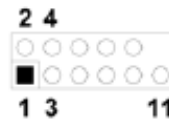

Table B.15: Front Panel Audio Connector (FPAUD1)

Pin	Signal	Pin	Signal
1	ACZ_VCC	2	GND
3	ACZ_SYNC	4	ACZ_BITCLK
5	ACZ_SDOOUT	6	ACZ_SDIN0
7	ACZ_SDIN1	8	ACZ_RST
9	ACZ_12V	10	GND
11	GND	12	N/C

B.16 8-pin Alarm Board Connector (VOLT1)

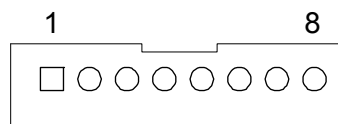

Table B.16: 8-pin Alarm Board Connector (VOLT1)

Pin	Signal	Pin	Signal
1	5VSB	5	+5V
2	GND	6	+3.3V
3	GND	7	-12V
4	-5V	8	+12V

B.17 Case Open Connector (JCASE1)

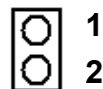

Table B.17: Case Open Connector (JFP1)

Pin	Signal
1	CASEOP
2	GND

B.18 Front Panel LAN LED Connector (LANLED1)

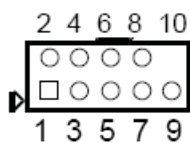

Table B.18: LAN LED Connector (LANLED1)

Pin	Signal	Pin	Signal
1	LAN1/3_LED0_ACT	2	LAN2/4_LED1_ACT
3	VCC3_LAN1LED	4	VCC3_LAN2LED
5	LAN1/3_LED1_1000M	6	LAN2/4_LED2_1000
7	LAN1/3_LED2_100M	8	LAN2/4_LED0_100
9	VCC3	10	N/C

ADVANTECH

Enabling an Intelligent Planet

www.advantech.com

Please verify specifications before quoting. This guide is intended for reference purposes only.

All product specifications are subject to change without notice.

No part of this publication may be reproduced in any form or by any means, electronic, photocopying, recording or otherwise, without prior written permission of the publisher.

All brand and product names are trademarks or registered trademarks of their respective companies.

© Advantech Co., Ltd. 2015