

DIN Rail Mount 22.5 mm ETM Part number 84874014



Version ETM :

- Controls temperature of machines using built-in PTC probes
- Line break or probe short-circuit detection

Version ETM2 / ETM22 :

- Fault latching function
- Pushbutton for local reset
- Remote reset via external contact
- Pushbutton test facility
- 2 LEDs to indicate relay and power supply status

Part numbers

	Type	Output	Supply voltage
84874014	ETM	1 N/O contact	230 V AC

Specifications

Supply voltage Un	230, 120 and 24 VAC 50 / 60 Hz Galvanic isolation by transformer 24 VDC no galvanic isolation
Operating range	0.85 to 1.10 Un
Nominal power	3 VA
Maximal power	5 VA
Immunity from micro power cuts	10 ms
Delay on pick-up	500 ms
Insulation coordination	Category III, degree of pollution 2 conforming to IEC/EN 60664-1 / VDE 0110 : 4 KV/2
Max. resistance of cold probes	1500 Ω
Trip threshold	3100 Ω ± 10 %
Reset threshold	1650 Ω ± 10 %
Short-circuit detection	0 - 10 Ω
Measurement voltage as per IEC/EN 60034-11	≤ 2,5 V
Repetition accuracy with constant parameters	± 0.5 %
Temperature drift	± 0.05 % / °C
Voltage-dependent drift	-2 %
Output	AgNi 90/10
Breaking capacity	2000 VA / 80 W
Max. breaking current	8 A AC
Max. breaking voltage	440 V AC
Min. breaking current	100 mA
Maximum rate	360 operations / hour at full load
Mechanical life (operations)	5 x 10 ⁶
Electrical life	AC12 : 2000 VA - 10 ⁵ operations AC15 : Cos φ = 0,3 - 6000 operations DC13 : L/R = 300 ms - 6000 operations
Reset time	≤ 500 ms
Response time	≤ 500 ms
Display on ETM2/ETM22 - power supply	green LED
Display on ETM2/ETM22 - Relay	yellow LED
Class of protection (IEC EN/60529) - Term. block	IP 20
Protection class (IEC EN/60529) - Casing	IP 50
Housing material	Self-extinguishing
Weight (g)	145
Terminal capacity	2 x 1.5 mm ² with ferrule 2 x 2.5 mm ² without ferrule
Temperature limit operation (IEC 68.1.14) (°C)	-20 → +60 °C
Temperature limits stored (IEC 68.1.1/2) (°C)	-30 → +70 °C
Relative humidity (no condensation)	95 % (+2 % ; -3 %)

Principles

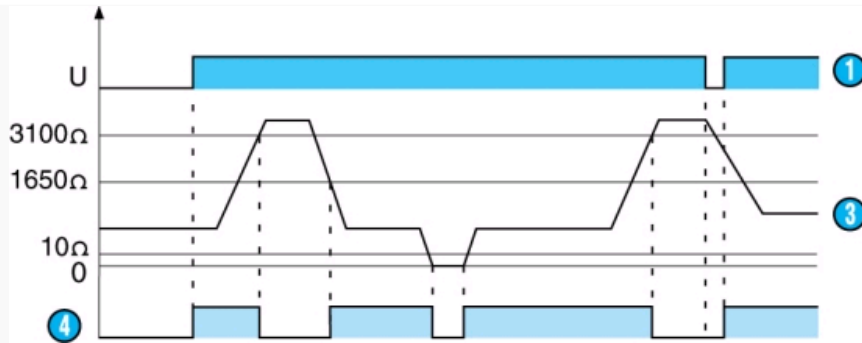

Operating principle

Control relay is used in combination with PTC thermistor probes (not supplied) for thermal protection of machines (motors, alternators, transformers, etc). The probes are placed at critical points on the equipment to be protected (normally inserted into the stator windings of motors). The resistance of the PTC probe has a positive temperature coefficient. As soon as the nominal trip temperature of the probe is exceeded, the resistance of the probe increases rapidly. Protection relay detects this and opens the power supply circuit of the protected equipment (eg motor) and the yellow fault indicator LED lights up (version ETM2/ETM22).

Test button

The ETM2/ETM22 has a TEST button which can be used to simulate a thermal overload in order to test the service condition of the relay.

Tripping

The relay drops out as soon as the protected equipment is subjected to a thermal overload, short-circuit or break in the probe measuring circuit.

Early warning of tripping

If the equipment being protected has another PTC probe with a lower nominal trip temperature, a second ETM/ETM2/ETM22 relay can be used to give early warning of tripping and thus prevent breaks in operation.

Control relay ETM/ETM2/ETM22 is automatically reset as soon as the temperature drops below the trip threshod (the yellow fault indicator LED goes out).

N°	Legend
1	Unit power-up
2	Resistance between terminals T1 and T2
3	Output relay

Principles

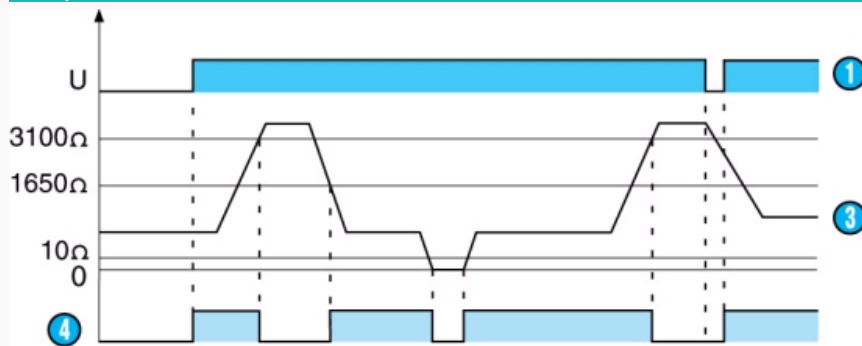

The relay is reset either using the RESET pushbutton on the front face or by opening the external contact S2 (remote reset), or by cutting the auxiliary power supply (terminals A1 - A2). If the auxiliary power is cut for a period of time greater than the reset time (500 ms), the relay is reactivated if the probe detects a normal temperature when the power supply voltage is restored.

N°	Legend
1	Unit power-up
2	Latching contact
3	Resistance between terminals T1 and T2
4	Output relay

Principles

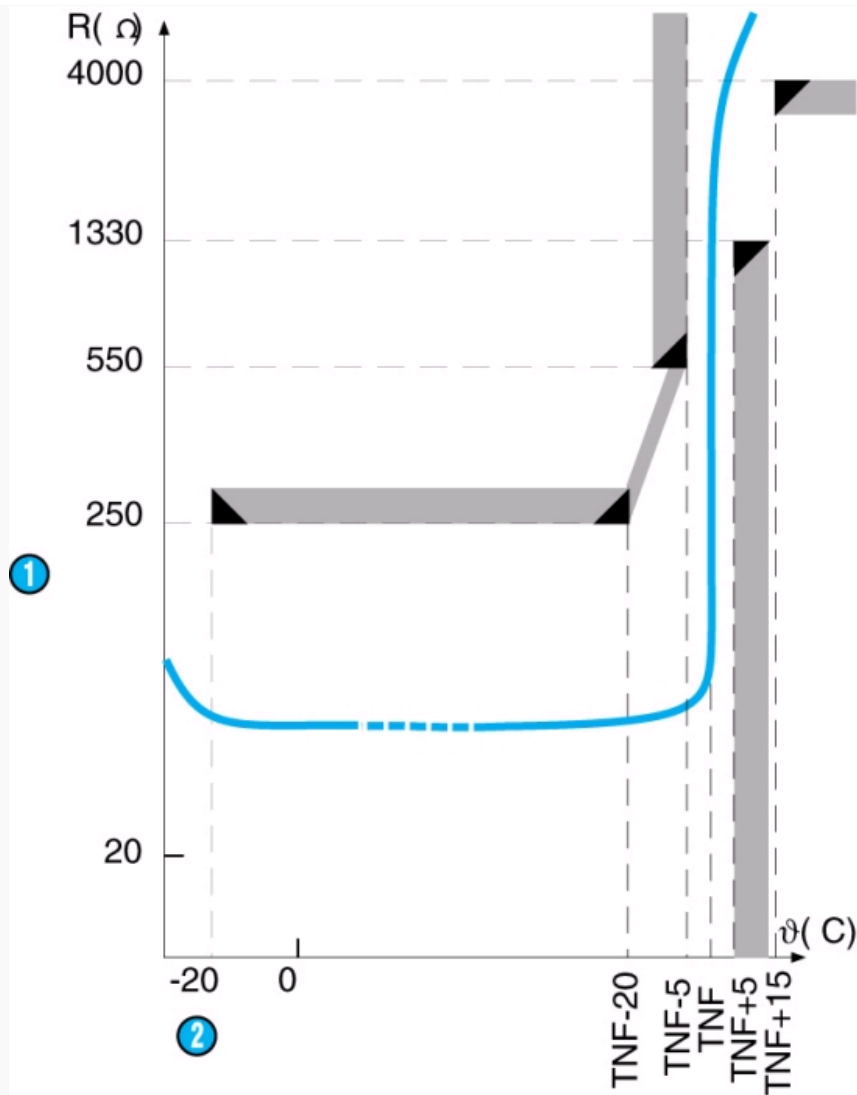

The relay is reset either using the RESET pushbutton on the front face or by opening the external contact S2 (remote reset), or by cutting the auxiliary power supply (terminals A1 - A2).
If the auxiliary power is cut for a period of time greater than the reset time (500 ms), the relay is reactivated if the probe detects a normal temperature when the power supply voltage is restored.

N°	Legend
①	Resistance R (Ω)
②	Nominal temperature Tripping ($^{\circ}\text{C}$)

Connections

ETM

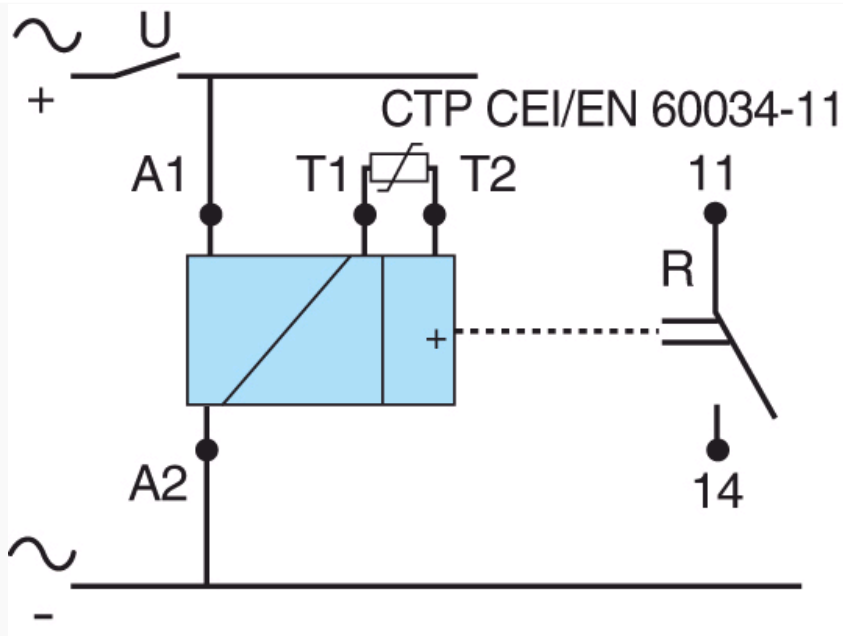

Legend
A1 - A2 : Supply voltage
11 - 14 : Output relay
T1 - T2 : External PTC probe

Connections

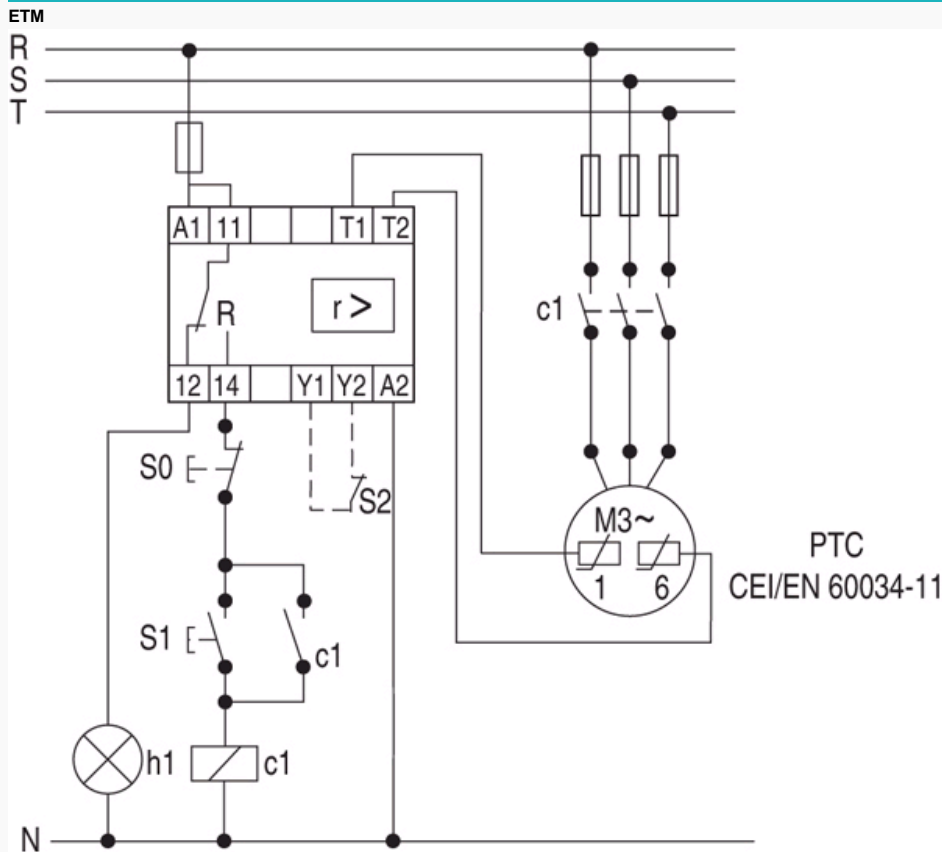

Legend
C1 : Contactor
S1 : ON button

S0 : OFF button

S2 : Remote reset contact

h1 : Fault indicator

Connections

CA 84874013

CA 84874013