

FEATURES

- 2.8MSPS Conversion Rate
- Low Power Dissipation: 14mW
- 3V Single Supply Operation
- -40°C to 125°C Guaranteed Operation
- 2.5V Internal Bandgap Reference can be Overdriven
- 3-Wire Serial Interface
- Sleep (10μW) Shutdown Mode
- Nap (3mW) Shutdown Mode
- 80dB Common Mode Rejection
- 0V to 2.5V Unipolar Input Range
- Tiny 10-Lead MS Package

APPLICATIONS

- Automotive
- Communications
- Data Acquisition Systems
- Uninterrupted Power Supplies
- Multiphase Motor Control
- Multiplexed Data Acquisition

DESCRIPTION

The **LTC[®]1403/LTC1403A** are 12-bit/14-bit, 2.8MSPS serial ADCs with differential inputs. The devices draw only 4.7mA from a single 3V supply and come in a tiny 10-lead MS package. A Sleep shutdown feature lowers power consumption to 10μW. The combination of speed, low power and tiny package makes the LTC1403/LTC1403A suitable for high speed, portable applications.

The 80dB common mode rejection allows users to eliminate ground loops and common mode noise by measuring signals differentially from the source.

The devices convert 0V to 2.5V unipolar inputs differentially. The absolute voltage swing for +A_{IN} and -A_{IN} extends from ground to the supply voltage.

The serial interface sends out the conversion results during the 16 clock cycles following CONV↑ for compatibility with standard serial interfaces. If two additional clock cycles for acquisition time are allowed after the data stream in between conversions, the full sampling rate of 2.8MSPS can be achieved with a 50.4MHz clock.

LT, LT, LTC, LTM, Linear Technology and the Linear Logo are registered trademarks and LinearView and SoftSpan are trademarks of Linear Technology Corporation. All other trademarks are the property of their respective owners.

BLOCK DIAGRAM

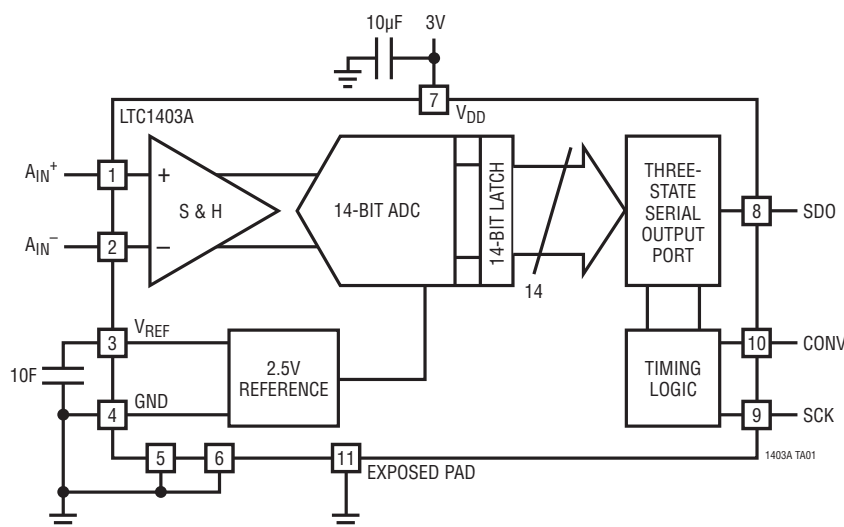

2nd, 3rd and SFDR vs Input Frequency

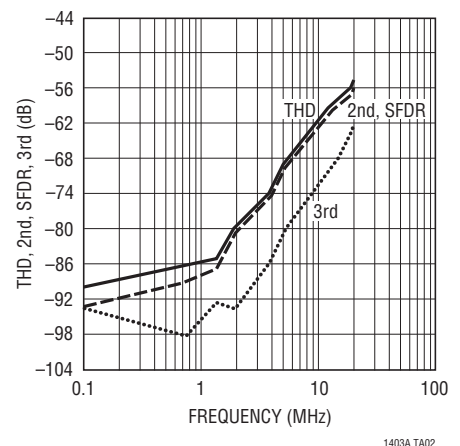

1403A TA02

1403fc

LTC1403/LTC1403A

ABSOLUTE MAXIMUM RATINGS

(Note 1, 2,)

Supply Voltage (V_{DD})	4V
Analog Input Voltage	
(Note 3)	-0.3V to ($V_{DD} + 0.3V$)
Digital Input Voltage.....	-0.3V to ($V_{DD} + 0.3V$)
Digital Output Voltage.....	-0.3V to ($V_{DD} + 0.3V$)
Power Dissipation	100mW
Operation Temperature Range	
LTC1403C/LTC1403AC.....	0°C to 70°C
LTC1403I/LTC1403AI.....	-40°C to 85°C
LTC1403H/LTC1403AH.....	-40°C to 125°C
Storage Temperature Range	-65°C to 150°C
Lead Temperature (Soldering, 10 sec).....	300°C

PIN CONFIGURATION

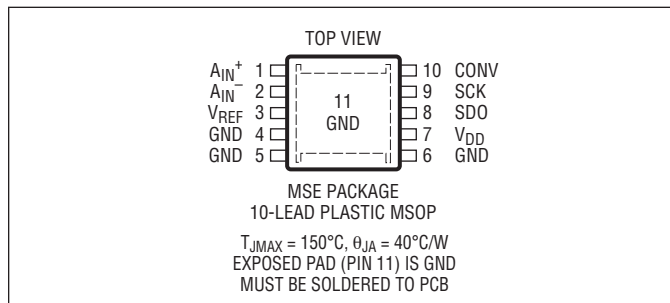

ORDER INFORMATION <http://www.linear.com/product/LTC1403#orderinfo>

LEAD FREE FINISH	TAPE AND REEL	PART MARKING*	PACKAGE DESCRIPTION	TEMPERATURE RANGE
LTC1403CMSE#PBF	LTC1403CMSE#TRPBF	LTBDN	10-Lead Plastic MSOP	0°C to 70°C
LTC1403IMSE#PBF	LTC1403IMSE#TRPBF	LTBDP	10-Lead Plastic MSOP	-40°C to 85°C
LTC1403HMSE#PBF	LTC1403HMSE#TRPBF	LTBDP	10-Lead Plastic MSOP	-40°C to 125°C
LTC1403ACMSE#PBF	LTC1403ACMSE#TRPBF	LTADF	10-Lead Plastic MSOP	0°C to 70°C
LTC1403AIMSE#PBF	LTC1403AIMSE#TRPBF	LTAFD	10-Lead Plastic MSOP	-40°C to 85°C
LTC1403AHMSE#PBF	LTC1403AHMSE#TRPBF	LTAFD	10-Lead Plastic MSOP	-40°C to 125°C

Consult LTC Marketing for parts specified with wider operating temperature ranges. *The temperature grade is identified by a label on the shipping container.

For more information on lead free part marking, go to: <http://www.linear.com/leadfree/>

For more information on tape and reel specifications, go to: <http://www.linear.com/tapeandree/>. Some packages are available in 500 unit reels through designated sales channels with #TRMPBF suffix.

CONVERTER CHARACTERISTICS

The ● denotes the specifications which apply over the full operating temperature range, otherwise specifications are at $T_A = 25^\circ\text{C}$. With internal reference. $V_{DD} = 3\text{V}$

PARAMETER	CONDITIONS	LTC1403			LTC1403H			LTC1403A			LTC1403AH			UNITS	
		MIN	TYP	MAX	MIN	TYP	MAX	MIN	TYP	MAX	MIN	TYP	MAX		
Resolution (No Missing Codes)		●	12		12		14		14		14		Bits		
Integral Linearity Error	(Notes 4, 5, 18)	●	-2	± 0.25	2	-2	± 0.25	2	-4	± 0.5	4	-4	± 0.5	4	LSB
Offset Error	(Notes 4, 18)	●	-10	± 1	10	-20	± 2	20	-20	± 2	20	-30	± 2	30	LSB
Gain Error	(Note 4, 18)	●	-30	± 5	30	-40	± 5	40	-60	± 10	60	-80	± 10	80	LSB
Gain Tempco	Internal Reference (Note 4) External Reference			± 15			± 15			± 15			± 15		ppm/ $^\circ\text{C}$ ppm/ $^\circ\text{C}$

ANALOG INPUT

The ● denotes the specifications which apply over the full operating temperature range, otherwise specifications are at $T_A = 25^\circ\text{C}$. $V_{DD} = 3\text{V}$

SYMBOL	PARAMETER	CONDITIONS	MIN	TYP	MAX	UNITS
V_{IN}	Analog Differential Input Range (Notes 3, 9)	$2.7\text{V} \leq V_{DD} \leq 3.3\text{V}$	●	0 to 2.5		V
V_{CM}	Analog Common Mode + Differential Input Range (Note 10)			0 to V_{DD}		V
I_{IN}	Analog Input Leakage Current		●		1	μA
C_{IN}	Analog Input Capacitance			13		pF
t_{ACQ}	Sample-and-Hold Acquisition Time	(Note 6)	●		39	ns
t_{AP}	Sample-and-Hold Aperture Delay Time			1		ns
t_{JITTER}	Sample-and-Hold Aperture Delay Time Jitter			0.3		ps
CMRR	Analog Input Common Mode Rejection Ratio	$f_{IN} = 1\text{MHz}$, $V_{IN} = 0\text{V}$ to 3V $f_{IN} = 100\text{MHz}$, $V_{IN} = 0\text{V}$ to 3V		-60		dB
				-15		dB

DYNAMIC ACCURACY

The ● denotes the specifications which apply over the full operating temperature range, otherwise specifications are at $T_A = 25^\circ\text{C}$. $V_{DD} = 3\text{V}$

SYMBOL	PARAMETER	CONDITIONS	LTC1403/LTC1403H			LTC1403A/LTC1403AH			UNITS
			MIN	TYP	MAX	MIN	TYP	MAX	
SINAD	Signal-to-Noise Plus Distortion Ratio	100kHz Input Signal		70.5		73.5		dB	
		1.4MHz Input Signal	●	68	70.5	70	73.5	dB	
		1.4MHz Input Signal (H Grade)	●	67	70.5	69	73.0	dB	
		100kHz Input Signal, External $V_{REF} = 3.3\text{V}$, $V_{DD} \geq 3.3\text{V}$			72		76.3	dB	
		750kHz Input Signal, External $V_{REF} = 3.3\text{V}$, $V_{DD} \geq 3.3\text{V}$			72		76.3	dB	
THD	Total Harmonic Distortion	100kHz First 5 Harmonics		-87		-90		dB	
		1.4MHz First 5 Harmonics	●	-83	-76	-86	-78	dB	
SFDR	Spurious Free Dynamic Range	100kHz Input Signal		-87		-90		dB	
		1.4MHz Input Signal		-83		-86		dB	
IMD	Intermodulation Distortion	1.25V to 2.5V 1.25MHz into A_{IN}^+ , 0V to 1.25V, 1.2MHz into A_{IN}^-		-82		-82		dB	
	Code-to-Code Transition Noise	$V_{REF} = 2.5\text{V}$ (Note 18)		0.25		1		LSB _{RMS}	
	Full Power Bandwidth	$V_{IN} = 2.5\text{V}_{p-p}$, SDO = 11585LSB _{p-p} (Note 15)		50		50		MHz	
	Full Linear Bandwidth	$S/(N + D) \geq 68\text{dB}$		5		5		MHz	

LTC1403/LTC1403A

INTERNAL REFERENCE CHARACTERISTICS

The ● denotes the specifications which apply over the full operating temperature range, otherwise specifications are at $T_A = 25^\circ\text{C}$. $V_{DD} = 3\text{V}$

PARAMETER	CONDITIONS	MIN	TYP	MAX	UNITS
V_{REF} Output Voltage	$I_{OUT} = 0$		2.5		V
V_{REF} Output Tempco			15		ppm/ $^\circ\text{C}$
V_{REF} Line Regulation	$V_{DD} = 2.7\text{V}$ to 3.6V , $V_{REF} = 2.5\text{V}$		600		$\mu\text{V}/\text{V}$
V_{REF} Output Resistance	Load Current = 0.5mA		0.2		Ω
V_{REF} Settling Time			2		ms

DIGITAL INPUTS AND DIGITAL OUTPUTS

The ● denotes the specifications which apply over the full operating temperature range, otherwise specifications are at $T_A = 25^\circ\text{C}$. $V_{DD} = 3\text{V}$

SYMBOL	PARAMETER	CONDITIONS	MIN	TYP	MAX	UNITS
V_{IH}	High Level Input Voltage	$V_{DD} = 3.3\text{V}$	●	2.4		V
V_{IL}	Low Level Input Voltage	$V_{DD} = 2.7\text{V}$	●		0.6	V
I_{IN}	Digital Input Current	$V_{IN} = 0\text{V}$ to V_{DD}	●		± 10	μA
C_{IN}	Digital Input Capacitance			5		pF
V_{OH}	High Level Output Voltage	$V_{DD} = 3\text{V}$, $I_{OUT} = -200\mu\text{A}$	●	2.5	2.9	V
V_{OL}	Low Level Output Voltage	$V_{DD} = 2.7\text{V}$, $I_{OUT} = 160\mu\text{A}$ $V_{DD} = 2.7\text{V}$, $I_{OUT} = 1.6\text{mA}$	●		0.05 0.10	V V
I_{OZ}	Hi-Z Output Leakage D_{OUT}	$V_{OUT} = 0\text{V}$ to V_{DD}	●		± 10	μA
C_{OZ}	Hi-Z Output Capacitance D_{OUT}			1		pF
I_{SOURCE}	Output Short-Circuit Source Current	$V_{OUT} = 0\text{V}$, $V_{DD} = 3\text{V}$		20		mA
I_{SINK}	Output Short-Circuit Sink Current	$V_{OUT} = V_{DD} = 3\text{V}$		15		mA

POWER REQUIREMENTS

The ● denotes the specifications which apply over the full operating temperature range, otherwise specifications are at $T_A = 25^\circ\text{C}$. (Note 17)

SYMBOL	PARAMETER	CONDITIONS	MIN	TYP	MAX	UNITS
V_{DD}	Supply Voltage			2.7	3.6	V
I_{DD}	Positive Supply Voltage	Active Mode	●	4.7	7	mA
		Active Mode (LTC1403H, LTC1403AH)	●	5.2	8	mA
		Nap Mode	●	1.1	1.5	mA
		Nap Mode (LTC1403H, LTC1403AH)	●	1.2	1.8	mA
		Sleep Mode (LTC1403, LTC1403H)		2	15	μA
		Sleep Mode (LTC1403A, LTC1403AH)		2	10	μA
P_D	Power Dissipation	Active Mode with SCK in Fixed State (Hi or Lo)		12		mW

TIMING CHARACTERISTICS

The ● denotes the specifications which apply over the full operating temperature range, otherwise specifications are at $T_A = 25^\circ\text{C}$. $V_{DD} = 3\text{V}$

SYMBOL	PARAMETER	CONDITIONS	MIN	TYP	MAX	UNITS
$f_{\text{SAMPLE(MAX)}}$	Maximum Sampling Frequency per Channel (Conversion Rate)		● 2.8			MHz
$t_{\text{THROUGHPUT}}$	Minimum Sampling Period (Conversion + Acquisition Period)		●		357	ns
t_{SCK}	Clock Period	(Notes 16)	● 19.8		10000	ns
t_{CONV}	Conversion Time	(Note 6)	17	18		SCLK cycles
t_1	Minimum Positive or Negative SCLK Pulse Width	(Note 6)	2			ns
t_2	CONV to SCK Setup Time	(Notes 6, 10)	3			ns
t_3	Nearest SCK Edge Before CONV	(Note 6)	0			ns
t_4	Minimum Positive or Negative CONV Pulse Width	(Note 6)	4			ns
t_5	SCK to Sample Mode	(Note 6)	4			ns
t_6	CONV to Hold Mode	(Notes 6, 11)	1.2			ns
t_7	16th SCK \uparrow to CONV \uparrow Interval (Affects Acquisition Period)	(Notes 6, 7, 13)	45			ns
t_8	Minimum Delay from SCK to Valid Bits 0 Through 13	(Notes 6, 12)			8	ns
t_9	SCK to Hi-Z at SDO	(Notes 6, 12)			6	ns
t_{10}	Previous SDO Bit Remains Valid After SCK	(Notes 6, 12)	2			ns
t_{12}	V_{REF} Settling Time After Sleep-to-Wake Transition	(Notes 6, 14)		2		ms

Note 1: Stresses beyond those listed under Absolute Maximum Ratings may cause permanent damage to the device. Exposure to any Absolute Maximum Rating condition for extended periods may affect device reliability and lifetime.

Note 2: All voltage values are with respect to GND.

Note 3: When these pins are taken below GND or above V_{DD} , they will be clamped by internal diodes. This product can handle input currents greater than 100mA below GND or greater than V_{DD} without latchup.

Note 4: Offset and full-scale specifications are measured for a single-ended A_{IN+} input with A_{IN-} grounded and using the internal 2.5V reference.

Note 5: Integral linearity is tested with an external 2.55V reference and is defined as the deviation of a code from the straight line passing through the actual endpoints of a transfer curve. The deviation is measured from the center of quantization band.

Note 6: Guaranteed by design, not subject to test.

Note 7: Recommended operating conditions.

Note 8: The analog input range is defined for the voltage difference between A_{IN+} and A_{IN-} .

Note 9: The absolute voltage at A_{IN+} and A_{IN-} must be within this range.

Note 10: If less than 3ns is allowed, the output data will appear one clock cycle later. It is best for CONV to rise half a clock before SCK, when running the clock at rated speed.

Note 11: Not the same as aperture delay. Aperture delay is smaller (1ns) because the 2.2ns delay through the sample-and-hold is subtracted from the CONV to Hold mode delay.

Note 12: The rising edge of SCK is guaranteed to catch the data coming out into a storage latch.

Note 13: The time period for acquiring the input signal is started by the 16th rising clock and it is ended by the rising edge of convert.

Note 14: The internal reference settles in 2ms after it wakes up from Sleep mode with one or more cycles at SCK and a 10 μF capacitive load.

Note 15: The full power bandwidth is the frequency where the output code swing drops to 3dB with a 2.5V_{P-P} input sine wave.

Note 16: Maximum clock period guarantees analog performance during conversion. Output data can be read without an arbitrarily long clock.

Note 17: $V_{DD} = 3\text{V}$, $f_{\text{SAMPLE}} = 2.8\text{MSPS}$.

Note 18: The LTC1403A is measured and specified with 14-bit Resolution (1LSB = 152 μV) and the LTC1403 is measured and specified with 12-bit Resolution (1LSB = 610 μV).

TYPICAL PERFORMANCE CHARACTERISTICS $T_A = 25^\circ\text{C}$, $V_{DD} = 3\text{V}$ (LTC1403A)

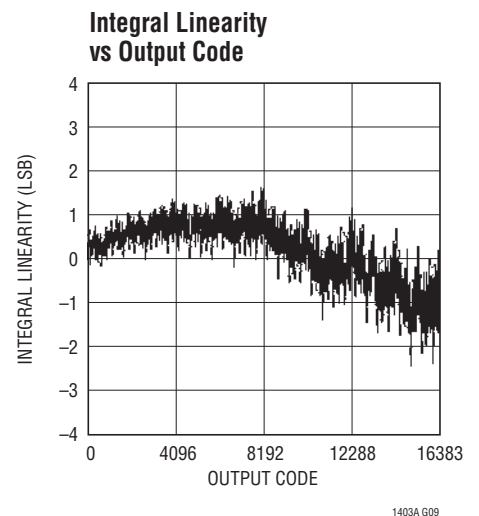
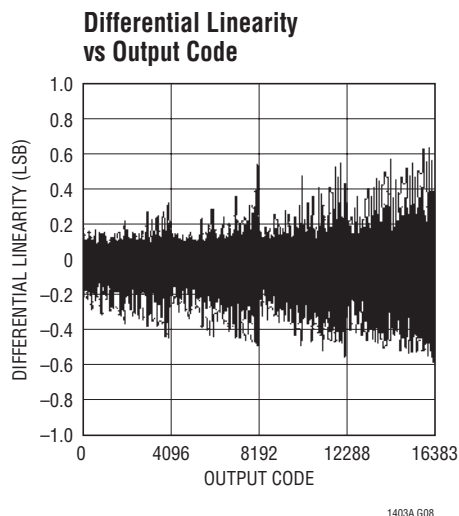
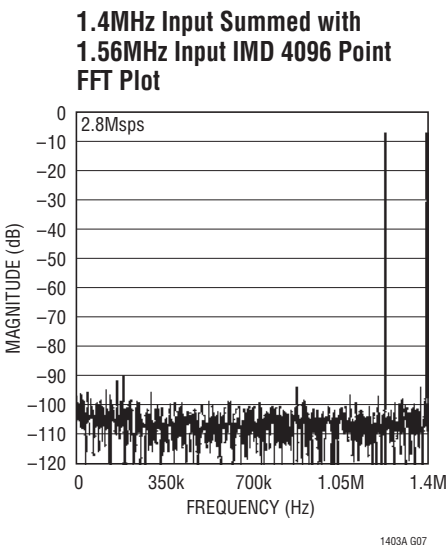
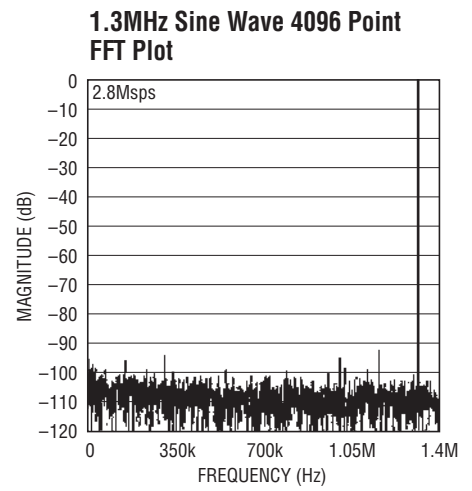
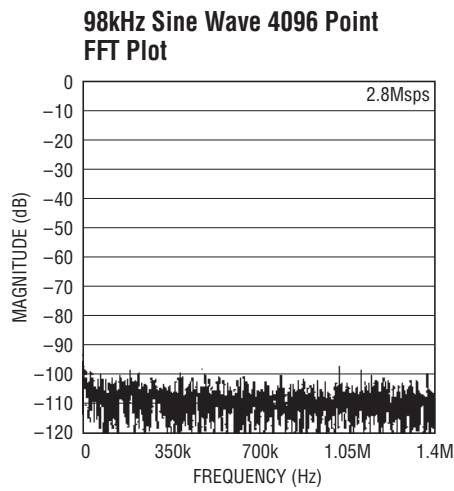
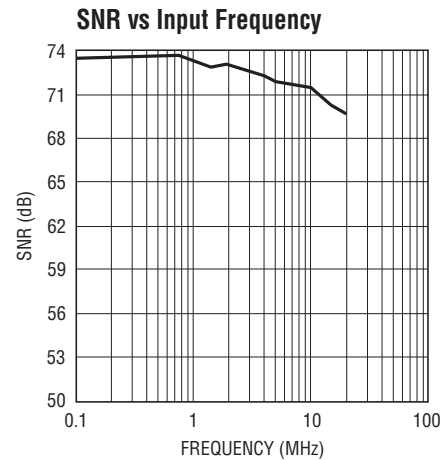
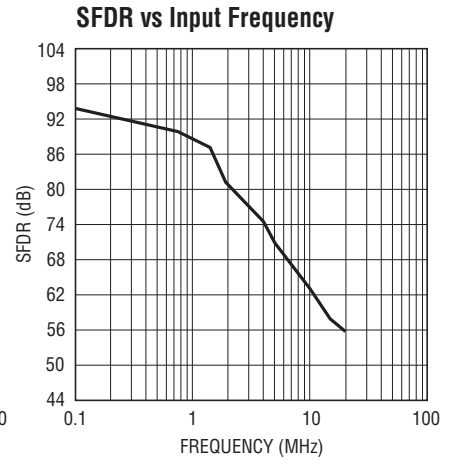
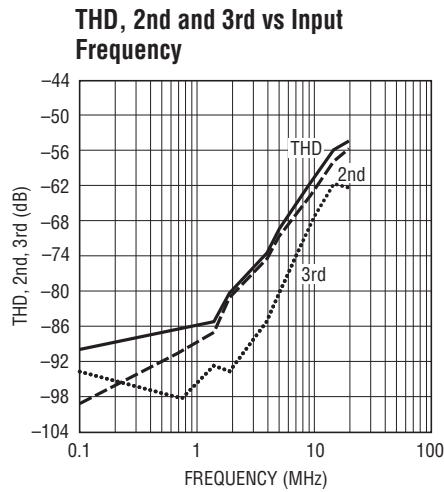
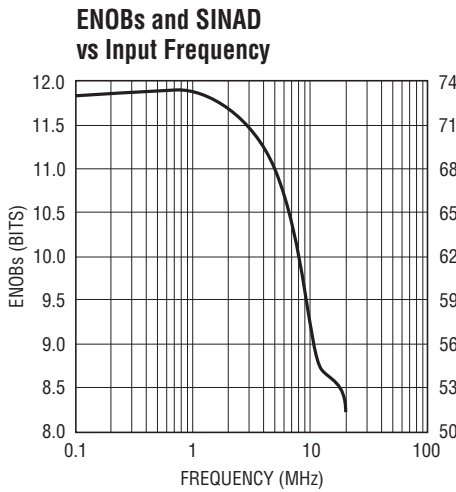

TYPICAL PERFORMANCE CHARACTERISTICS $T_A = 25^\circ\text{C}$, $V_{DD} = 3\text{V}$ (LTC1403A)

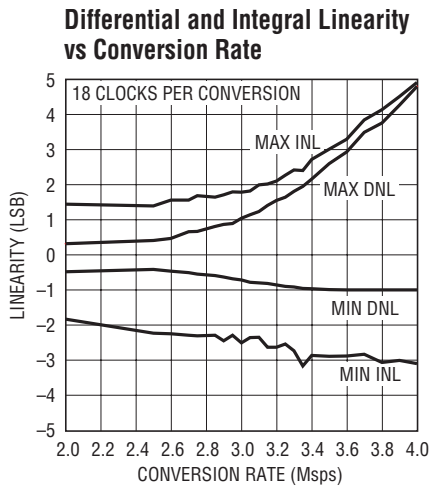

1403A G10

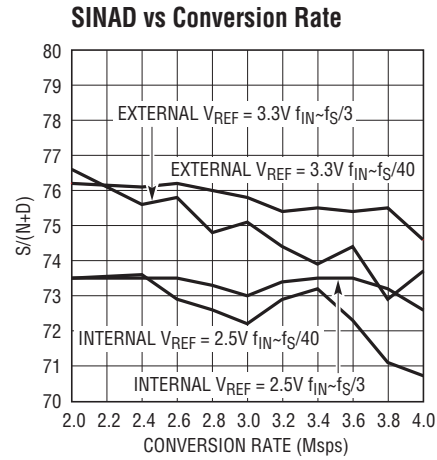

1403A G11

$T_A = 25^\circ\text{C}$, $V_{DD} = 3\text{V}$ (LTC1403 and LTC1403A)

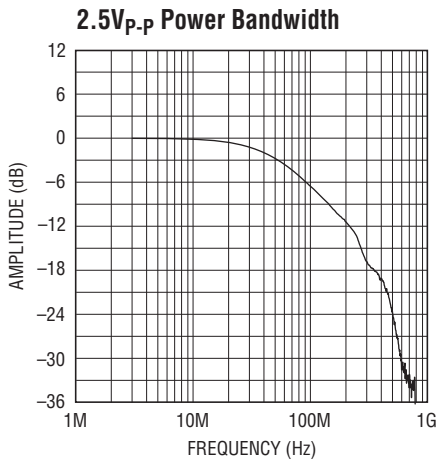

1403A G12

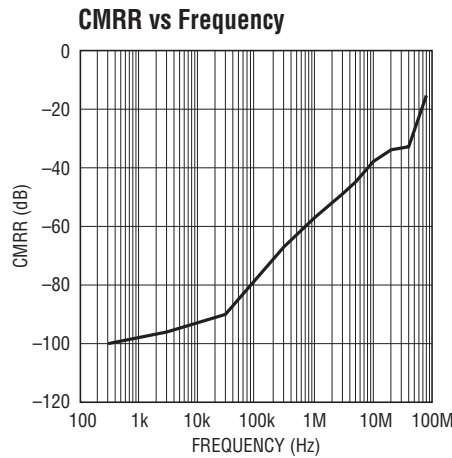

1403A G13

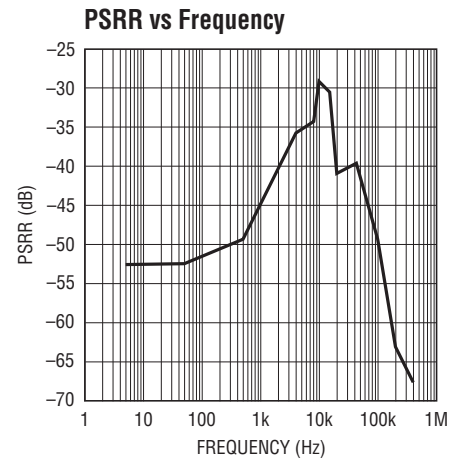

1403A G14

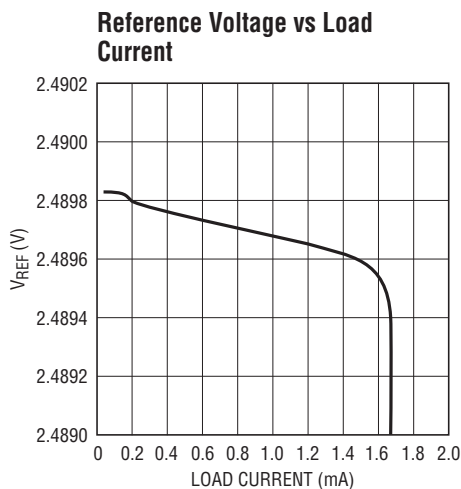

1403A G15

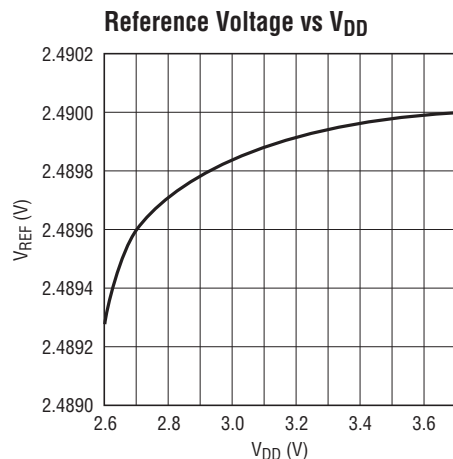

1403A G16

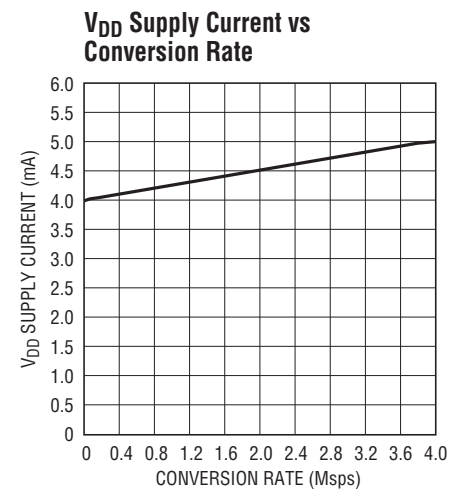

1403A G17

1403fc

PIN FUNCTIONS

A_{IN}^+ (Pin 1): Noninverting Analog Input. A_{IN}^+ operates fully differentially with respect to A_{IN}^- with a 0V to 2.5V differential swing and a 0V to V_{DD} common mode swing.

A_{IN}^- (Pin 2): Inverting Analog Input. A_{IN}^- operates fully differentially with respect to A_{IN}^+ with a -2.5V to 0V differential swing and a 0V to V_{DD} common mode swing.

V_{REF} (Pin 3): 2.5V Internal Reference. Bypass to GND and to a solid analog ground plane with a 10 μ F ceramic capacitor (or 10 μ F tantalum in parallel with 0.1 μ F ceramic). Can be overdriven by an external reference between 2.55V and V_{DD} .

GND (Pins 5, 6, 11): Ground and Exposed Pad. These ground pins and the exposed pad must be tied directly to the solid ground plane under the part. Keep in mind that analog signal currents and digital output signal currents flow through these pins.

V_{DD} (Pin 7): 3V Positive Supply. This single power pin supplies 3V to the entire chip. Bypass to GND and to a

solid analog ground plane with a 10 μ F ceramic capacitor (or 10 μ F tantalum in parallel with 0.1 μ F ceramic). Keep in mind that internal analog currents and digital output signal currents flow through this pin. Care should be taken to place the 0.1 μ F bypass capacitor as close to Pins 6 and 7 as possible.

SDO (Pin 8): Three-State Serial Data Output. Each of output data words represents the difference between A_{IN}^+ and A_{IN}^- analog inputs at the start of the previous conversion.

SCK (Pin 9): External Clock Input. Advances the conversion process and sequences the output data on the rising edge. Responds to TTL ($\leq 3V$) and 3V CMOS levels. One or more pulses wake from sleep.

CONV (Pin 10): Convert Start. Holds the analog input signal and starts the conversion on the rising edge. Responds to TTL ($\leq 3V$) and 3V CMOS levels. Two pulses with SCK in fixed high or fixed low state start Nap mode. Four or more pulses with SCK in fixed high or fixed low state start Sleep mode.

BLOCK DIAGRAM

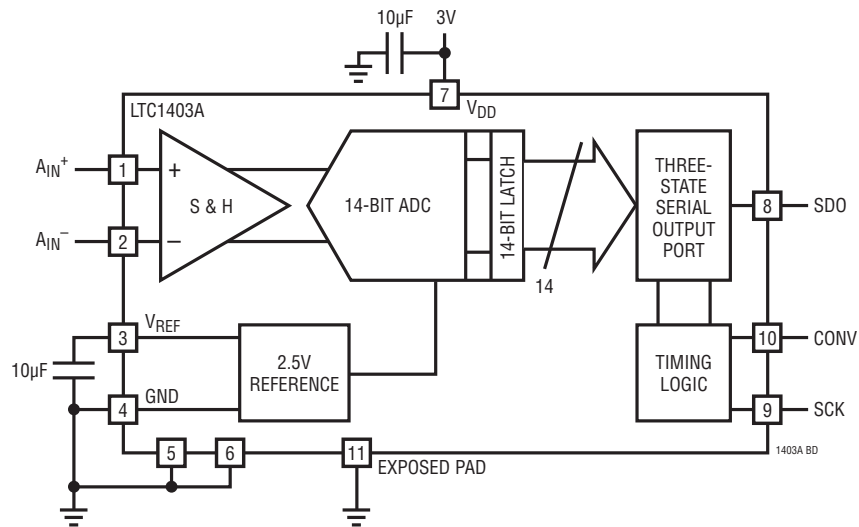

TIMING DIAGRAM

LTC1403 Timing Diagram

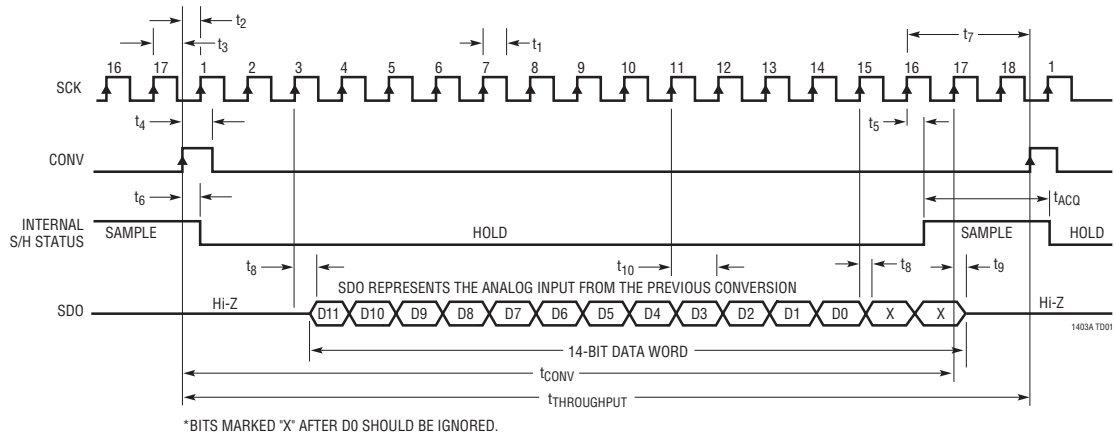

LTC1403A Timing Diagram

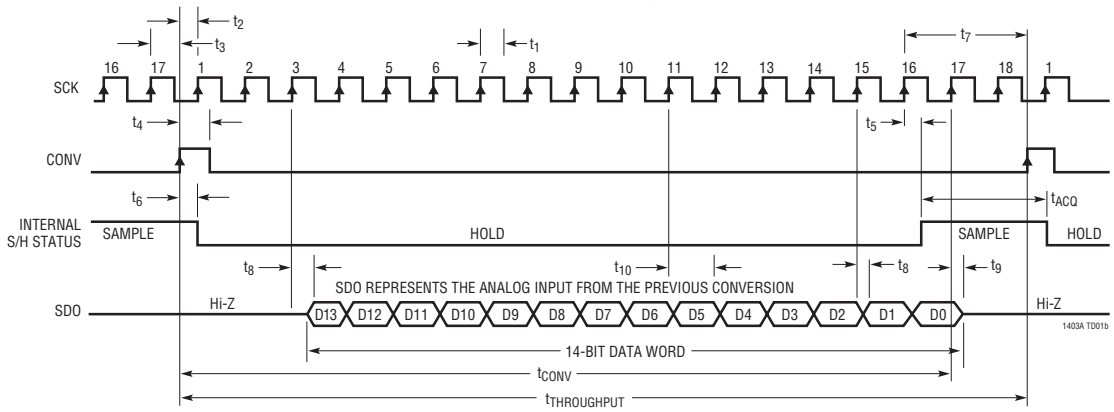

Nap Mode and Sleep Mode Waveforms

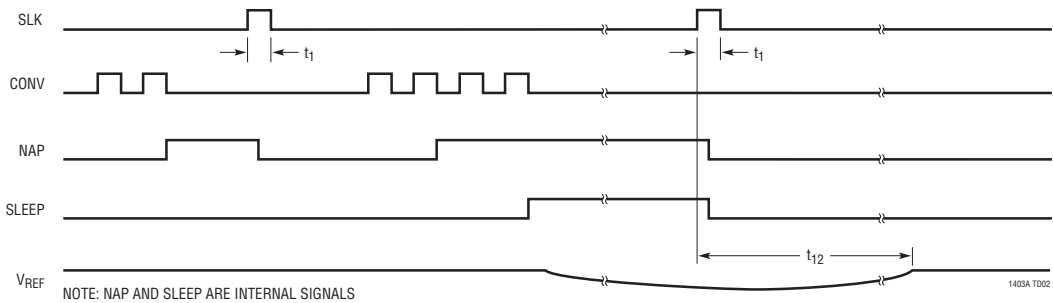

SCK to SDO Delay

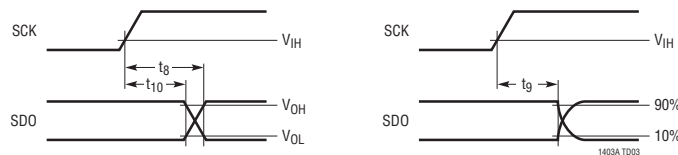

APPLICATIONS INFORMATION

DRIVING THE ANALOG INPUT

The differential analog inputs of the LTC1403/LTC1403A are easy to drive. The inputs may be driven differentially or as a single-ended input (i.e., the A_{IN}^- input is grounded). Both differential analog inputs, A_{IN}^+ with A_{IN}^- , are sampled at the same instant. Any unwanted signal that is common to both inputs of each input pair will be reduced by the common mode rejection of the sample-and-hold circuit. The inputs draw only one small current spike while charging the sample-and-hold capacitors at the end of conversion. During conversion, the analog inputs draw only a small leakage current. If the source impedance of the driving circuit is low, then the LTC1403/LTC1403A inputs can be driven directly. As source impedance increases, so will acquisition time. For minimum acquisition time with high source impedance, a buffer amplifier must be used. The main requirement is that the amplifier driving the analog input(s) must settle after the small current spike before the next conversion starts (settling time must be 39ns for full throughput rate). Also keep in mind while choosing an input amplifier, the amount of noise and harmonic distortion added by the amplifier.

CHOOSING AN INPUT AMPLIFIER

Choosing an input amplifier is easy if a few requirements are taken into consideration. First, to limit the magnitude of the voltage spike seen by the amplifier from charging the sampling capacitor, choose an amplifier that has a low output impedance ($<100\Omega$) at the closed-loop bandwidth frequency. For example, if an amplifier is used in a gain of 1 and has a unity-gain bandwidth of 50MHz, then the output impedance at 50MHz must be less than 100Ω . The second requirement is that the closed-loop bandwidth must be greater than 40MHz to ensure adequate small-signal settling for full throughput rate. If slower op amps are used, more time for settling can be provided by increasing the time between conversions. The best choice for an op amp to drive the LTC1403/LTC1403A will depend on the application. Generally, applications fall into two categories: AC applications where dynamic specifications are most critical and time domain applications where DC accuracy and settling time are most critical. The following list is a summary of the op amps that are suitable for driving the LTC1403/LTC1403A. (More detailed information is

available in the Linear Technology Databooks and on the LinearView™ CD-ROM.)

LT®1566-1: Low Noise 2.3MHz Continuous Time Low-Pass Filter.

LT1630: Dual 30MHz Rail-to-Rail Voltage FB Amplifier. 2.7V to $\pm 15V$ supplies. Very high A_{VOL} , 500 μV offset and 520ns settling to 0.5LSB for a 4V swing. THD and noise are $-93dB$ to 40kHz and below 1LSB to 320kHz ($A_V = 1$, $2V_{P-P}$ into $1k\Omega$, $V_S = 5V$), making the part excellent for AC applications (to $1/3$ Nyquist) where rail-to-rail performance is desired. Quad version is available as LT1631.

LT1632: Dual 45MHz Rail-to-Rail Voltage FB Amplifier. 2.7V to $\pm 15V$ supplies. Very high A_{VOL} , 1.5mV offset and 400ns settling to 0.5LSB for a 4V swing. It is suitable for applications with a single 5V supply. THD and noise are $-93dB$ to 40kHz and below 1LSB to 800kHz ($A_V = 1$, $2V_{P-P}$ into $1k\Omega$, $V_S = 5V$), making the part excellent for AC applications where rail-to-rail performance is desired. Quad version is available as LT1633.

LT1813: Dual 100MHz 750V/ μs 3mA Voltage Feedback Amplifier. 5V to $\pm 5V$ supplies. Distortion is $-86dB$ to 100kHz and $-77dB$ to 1MHz with $\pm 5V$ supplies ($2V_{P-P}$ into 500Ω). Excellent part for fast AC applications with $\pm 5V$ supplies.

LT1801: 80MHz GBWP, $-75dBc$ at 500kHz, 2mA/Amplifier, $8.5nV/\sqrt{Hz}$.

LT1806/LT1807: 325MHz GBWP, $-80dBc$ Distortion at 5MHz, Unity-Gain Stable, R-R In and Out, 10mA/Amplifier, $3.5nV/\sqrt{Hz}$.

LT1810: 180MHz GBWP, $-90dBc$ Distortion at 5MHz, Unity-Gain Stable, R-R In and Out, 15mA/Amplifier, $16nV/\sqrt{Hz}$.

LT1818/LT1819: 400MHz, 2500V/ μs , 9mA, Single/Dual Voltage Mode Operational Amplifier.

LT6200: 165MHz GBWP, $-85dBc$ Distortion at 1MHz, Unity-Gain Stable, R-R In and Out, 15mA/Amplifier, $0.95nV/\sqrt{Hz}$.

LT6203: 100MHz GBWP, $-80dBc$ Distortion at 1MHz, Unity-Gain Stable, R-R In and Out, 3mA/Amplifier, $1.9nV/\sqrt{Hz}$.

LT6600-10: Amplifier/Filter Differential In/Out with 10MHz Cutoff.

APPLICATIONS INFORMATION

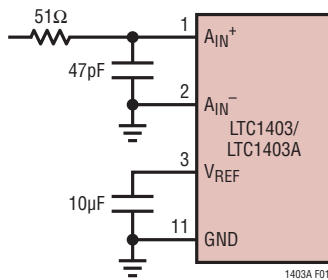

Figure 1. RC Input Filter

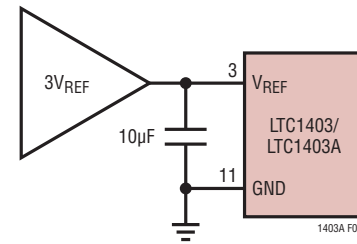

Figure 2

INPUT FILTERING AND SOURCE IMPEDANCE

The noise and the distortion of the input amplifier and other circuitry must be considered since they will add to the LTC1403/LTC1403A noise and distortion. The small-signal bandwidth of the sample-and-hold circuit is 50MHz. Any noise or distortion products that are present at the analog inputs will be summed over this entire bandwidth. Noisy input circuitry should be filtered prior to the analog inputs to minimize noise. A simple 1-pole RC filter is sufficient for many applications. For example, Figure 1 shows a 47pF capacitor from A_{IN}^+ to ground and a 51Ω source resistor to limit the input bandwidth to 47MHz. The 47pF capacitor also acts as a charge reservoir for the input sample-and-hold and isolates the ADC input from sampling-glitch sensitive circuitry. High quality capacitors and resistors should be used since these components can add distortion. NPO and silvermica type dielectric capacitors have excellent linearity. Carbon surface mount resistors can generate distortion from self heating and from damage that may occur during soldering. Metal film surface mount resistors are much less susceptible to both problems. When high amplitude unwanted signals are close in frequency to the desired signal frequency, a multiple pole filter is required. High external source resistance, combined with the 13pF of input capacitance, will reduce the rated 50MHz bandwidth and increase acquisition time beyond 39ns.

INPUT RANGE

The analog inputs of the LTC1403/LTC1403A may be driven fully differentially with a single supply. Each input may swing up to $3V_{P-P}$ individually. In the conversion range, the noninverting input of each channel is always up to 2.5V more positive than the inverting input of each channel. The 0V to 2.5V range is also ideally suited for single-ended input use with single supply applications. The common mode range of the inputs extend from ground to the supply voltage V_{DD} . If the difference between the A_{IN}^+ and A_{IN}^- inputs exceeds 2.5V, the output code will stay fixed at all ones and if this difference goes below 0V, the output code will stay fixed at all zeros.

INTERNAL REFERENCE

The LTC1403/LTC1403A has an on-chip, temperature compensated, bandgap reference that is factory trimmed near 2.5V to obtain 2.5V input span. The reference amplifier output V_{REF} , (Pin 3) must be bypassed with a capacitor to ground. The reference amplifier is stable with capacitors of 1μF or greater. For the best noise performance, a 10μF ceramic or a 10μF tantalum in parallel with a 0.1μF ceramic is recommended. The V_{REF} pin can be overdriven with an external reference as shown in Figure 2. The voltage of the external reference must be higher than the 2.5V of the class A pull-up output of the internal reference. The recommended range for an external reference is 2.55V to V_{DD} . An external reference at 2.55V will see a DC quiescent load of 0.75mA and as much as 3mA during conversion.

APPLICATIONS INFORMATION

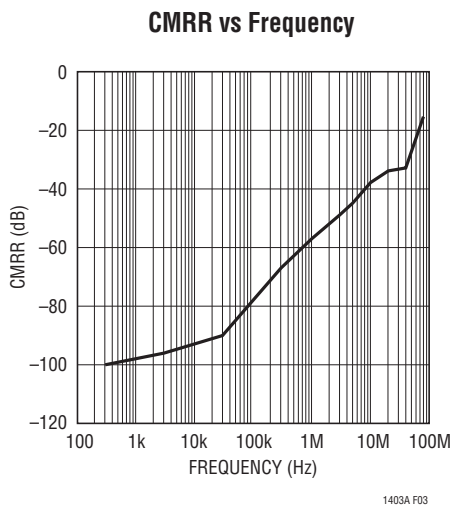

Figure 3

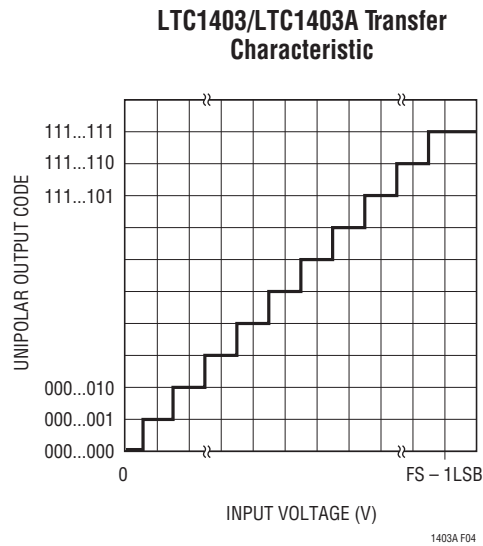

Figure 4

INPUT SPAN VERSUS REFERENCE VOLTAGE

The differential input range has a unipolar voltage span that equals the difference between the voltage at the reference buffer output V_{REF} at Pin 3, and the voltage at the ground (Exposed Pad Ground). The differential input range of the ADC is 0V to 2.5V when using the internal reference. The internal ADC is referenced to these two nodes. This relationship also holds true with an external reference.

DIFFERENTIAL INPUTS

The LTC1403/LTC1403A has a unique differential sample-and-hold circuit that allows inputs from ground to V_{DD} . The ADC will always convert the unipolar difference of $A_{IN}^+ - A_{IN}^-$, independent of the common mode voltage

at the inputs. The common mode rejection holds up at extremely high frequencies, see Figure 3. The only requirement is that both inputs not go below ground or exceed V_{DD} . Integral nonlinearity errors (INL) and differential nonlinearity errors (DNL) are largely independent of the common mode voltage. However, the offset error will vary. The change in offset error is typically less than 0.1% of the common mode voltage.

Figure 4 shows the ideal input/output characteristics for the LTC1403/LTC1403A. The code transitions occur midway between successive integer LSB values (i.e., 0.5LSB, 1.5LSB, 2.5LSB, FS - 1.5LSB). The output code is natural binary with $1\text{LSB} = 2.5\text{V}/16384 = 153\mu\text{V}$ for the LTC1403A, and $1\text{LSB} = 2.5\text{V}/4096 = 610\mu\text{V}$ for the LTC1403. The LTC1403A has 1LSB RMS of random white noise.

APPLICATIONS INFORMATION

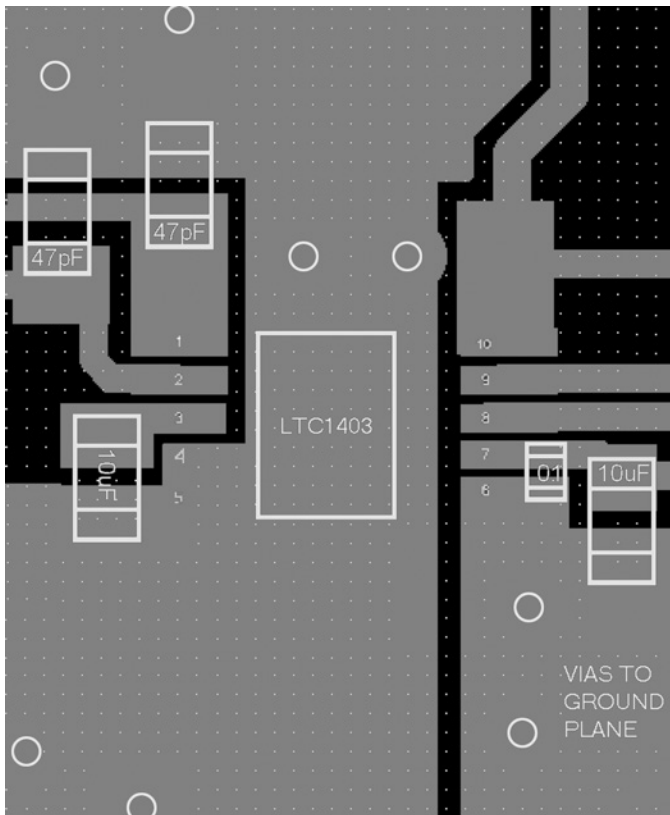

Figure 5. Recommended Layout

Board Layout and Bypassing

Wire wrap boards are not recommended for high resolution and/or high speed A/D converters. To obtain the best performance from the LTC1403/LTC1403A, a printed circuit board with ground plane is required. Layout for the printed circuit board should ensure that digital and analog signal lines are separated as much as possible. In particular, care should be taken not to run any digital track alongside an analog signal track. If optimum phase match between the inputs is desired, the length of the two input wires should be kept matched.

High quality tantalum and ceramic bypass capacitors should be used at the V_{DD} and V_{REF} pins as shown in the Block Diagram on the first page of this data sheet.

For optimum performance, a $10\mu\text{F}$ surface mount AVX capacitor with a $0.1\mu\text{F}$ ceramic is recommended for the V_{DD} and V_{REF} pins. Alternatively, $10\mu\text{F}$ ceramic chip capacitors such as Murata GRM235Y5V106Z016 may be used. The capacitors must be located as close to the pins as possible. The traces connecting the pins and the bypass capacitors must be kept short and should be made as wide as possible.

Figure 5 shows the recommended system ground connections. All analog circuitry grounds should be terminated at the LTC1403/LTC1403A GND (Pins 4, 5, 6 and exposed pad). The ground return from the LTC1403/LTC1403A (Pins 4, 5, 6 and exposed pad) to the power supply should be low impedance for noise free operation. Digital circuitry grounds must be connected to the digital supply common. In applications where the ADC data outputs and control signals are connected to a continuously active microprocessor bus, it is possible to get errors in the conversion results. These errors are due to feedthrough from the microprocessor to the successive approximation comparator. The problem can be eliminated by forcing the microprocessor into a Wait state during conversion or by using three-state buffers to isolate the ADC data bus.

POWER-DOWN MODES

Upon power-up, the LTC1403/LTC1403A is initialized to the active state and is ready for conversion. The Nap and Sleep mode waveforms show the power-down modes for the LTC1403/LTC1403A. The SCK and CONV inputs control the power-down modes (see Timing Diagrams). Two rising edges at CONV, without any intervening rising edges at SCK, put the LTC1403/LTC1403A in Nap mode and the power drain drops from 14mW to 6mW . The internal reference remains powered in Nap mode. One or more rising edges at SCK wake up the LTC1403/LTC1403A for service very quickly, and CONV can start an accurate conversion within a clock cycle. Four rising edges at CONV, without any

APPLICATIONS INFORMATION

intervening rising edges at SCK, put the LTC1403/LTC1403A in Sleep mode and the power drain drops from 16mW to 10 μ W. One or more rising edges at SCK wake up the LTC1403/LTC1403A for operation. The internal reference (V_{REF}) takes 2ms to slew and settle with a 10 μ F load. Note that, using sleep mode more frequently than every 2ms, compromises the settled accuracy of the internal reference. Note that, for slower conversion rates, the Nap and Sleep modes can be used for substantial reductions in power consumption.

DIGITAL INTERFACE

The LTC1403/LTC1403A has a 3-wire SPI (Serial Protocol Interface) interface. The SCK and CONV inputs and SDO output implement this interface. The SCK and CONV inputs accept swings from 3V logic and are TTL compatible, if the logic swing does not exceed V_{DD} . A detailed description of the three serial port signals follows:

Conversion Start Input (CONV)

The rising edge of CONV starts a conversion, but subsequent rising edges at CONV are ignored by the LTC1403/LTC1403A until the following 16 SCK rising edges have occurred and track mode starts again. It is also necessary to have a minimum of 17 rising edges of the clock input SCK between rising edges of CONV for SDO to go to the Hi-Z state and to prepare the internal ADC logic for the next conversion. But to obtain maximum conversion speed, it is necessary to allow one more clock period between conversions to allow 39ns of acquisition time for the internal ADC sample-and-hold circuit. With 17 clock periods per conversion, the maximum conversion rate is limited to 2.8Msps to allow 39ns for acquisition time. In either case, the output data stream comes out within the first 16 clock periods to ensure compatibility with processor serial ports. The duty cycle of CONV can be arbitrarily chosen to be used as a frame sync signal for the processor serial port. A simple approach to generate CONV is to create a pulse that is one SCK wide to drive the LTC1403/LTC1403A and then buffer this signal with

the appropriate number of inverters to ensure the correct delay driving the frame sync input of the processor serial port. It is good practice to drive the LTC1403/LTC1403A CONV input first to avoid digital noise interference during the sample-to-hold transition triggered by CONV at the start of conversion. It is also good practice to keep the width of the low portion of the CONV signal greater than 15ns to avoid introducing glitches in the front end of the ADC just before the sample-and-hold goes into hold mode at the rising edge of CONV.

Minimizing Jitter on the CONV Input

In high speed applications where high amplitude sinewaves above 100kHz are sampled, the CONV signal must have as little jitter as possible (10ps or less). The square wave output of a common crystal clock module usually meets this requirement easily. The challenge is to generate a CONV signal from this crystal clock without jitter corruption from other digital circuits in the system. A clock divider and any gates in the signal path from the crystal clock to the CONV input should not share the same integrated circuit with other parts of the system. As shown in the interface circuit examples, the SCK and CONV inputs should be driven first, with digital buffers used to drive the serial port interface. Also note that the master clock in the DSP may already be corrupted with jitter, even if it comes directly from the DSP crystal. Another problem with high speed processor clocks is that they often use a low cost, low speed crystal (i.e., 10MHz) to generate a fast, but jittery, phase-locked-loop system clock (i.e., 40MHz). The jitter in these PLL-generated high speed clocks can be several nanoseconds. Note that if you choose to use the frame sync signal generated by the DSP port, this signal will have the same jitter of the DSP's master clock.

Serial Clock Input (SCK)

The rising edge of SCK advances the conversion process and also updates each bit in the SDO data stream. After CONV rises, the third rising edge of SCK starts clocking out the 12/14 data bits with the MSB sent first. A simple approach is to generate SCK to drive the LTC1403/LTC1403A

APPLICATIONS INFORMATION

first and then buffer this signal with the appropriate number of inverters to drive the serial clock input of the processor serial port. Use the falling edge of the clock to latch data from the Serial Data Output (SDO) into your processor serial port. The 14-bit Serial Data will be received right justified, in a 16-bit word with 17 or more clocks per frame sync. It is good practice to drive the LTC1403/LTC1403A SCK input first to avoid digital noise interference during the internal bit comparison decision by the internal high speed comparator. Unlike the CONV input, the SCK input is not sensitive to jitter because the input signal is already sampled and held constant.

Serial Data Output (SDO)

Upon power-up, the SDO output is automatically reset to the high impedance state. The SDO output remains in high impedance until a new conversion is started. SDO sends out 12/14 bits in the output data stream beginning at the third rising edge of SCK after the rising edge of CONV. SDO is always in high impedance mode when it is not sending out data bits. Please note the delay specification from SCK to a valid SDO. SDO is always guaranteed to be valid by the next rising edge of SCK. The 16-bit output data stream is compatible with the 16-bit or 32-bit serial port of most processors.

HARDWARE INTERFACE TO TMS320C54X

The LTC1403/LTC1403A is a serial output ADC whose interface has been designed for high speed buffered serial ports in fast digital signal processors (DSPs). Figure 6 shows an example of this interface using a TMS320C54X.

The buffered serial port in the TMS320C54x has direct access to a 2kB segment of memory. The ADC's serial data can be collected in two alternating 1kB segments, in real time, at the full 2.8MSPS conversion rate of the LTC1403/LTC1403A. The DSP assembly code sets frame sync mode at the BFSR pin to accept an external positive going pulse and the serial clock at the BCLKR pin to accept an external positive edge clock. Buffers near the LTC1403/LTC1403A may be added to drive long tracks to the DSP to prevent corruption of the signal to LTC1403/LTC1403A. This configuration is adequate to traverse a typical system board, but source resistors at the buffer outputs and termination resistors at the DSP, may be needed to match the characteristic impedance of very long transmission lines. If you need to terminate the SDO transmission line, buffer it first with one or two 74ACTxx gates. The TTL threshold inputs of the DSP port respond properly to the 3V swing from the SDO pin.

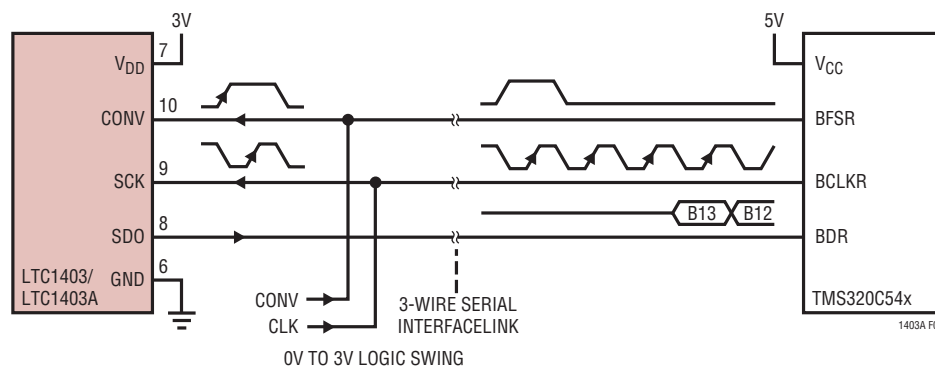

Figure 6. DSP Serial Interface to TMS320C54x

APPLICATIONS INFORMATION

```

; 01-08-01 *****
; Files: 014SI.ASM -> 1403A Sine wave collection with Serial Port interface
;     bvectors.asm     buffered mode to avoid standard mode bug.
;     s2k14ini.asm     2k buffer size.
; first element at 1024, last element at 1023, two middles at 2047 and 0000
; unipolar mode
; negative edge BCLKR
; negative BFSR pulse
; -0 data shifted
; 1' cable from counter to CONV at DUT
; 2' cable from counter to CLK at DUT
; *****

        .width 160
        .length 110
        .title "sineb0 BSP in auto buffer mode"
        .mmregs
        .setsect ".text", 0x500,0 ;Set address of executable
        .setsect "vectors", 0x180,0 ;Set address of incoming 1403 data
        .setsect "buffer", 0x800,0 ;Set address of BSP buffer for clearing
        .setsect "result", 0x1800,0 ;Set address of result for clearing
        .text ;.text marks start of code

start:
        ;this label seems necessary
        ;Make sure /PWRDWN is low at J1-9
        ;to turn off AC01 adc

        tim=#0fh
        prd=#0fh
        tcr = #10h ; stop timer
        tpsc = #0h ; stop TDM serial port to AC01
        pmst = #01a0h ; set up iptr. Processor Mode SStatus register
        sp = #0700h ; init stack pointer.
        dp = #0 ; data page
        ar2 = #1800h ; pointer to computed receive buffer.
        ar3 = #0800h ; pointer to Buffered Serial Port receive buffer
        ar4 = #0h ; reset record counter
        call sineinit ; Double clutch the initialization to insure a proper
sinepeek:
        call sineinit ; reset. The external frame sync must occur 2.5 clocks
        ; or more after the port comes out of reset.

wait    goto    wait

; -----Buffered Receive Interrupt Routine -----

breceive:
        ifr = #10h ; clear interrupt flags
        TC = bitf(@BSPCE,#4000h) ; check which half (bspce(bit14)) of buffer
        if (NTC) goto bufull ; if this still the first half get next half
        bspce = #(2023h + 08000h); turn on halt for second half (bspce(bit15))
        return _enable
; -----mask and shift input data -----

bufull:
        b = *ar3+ << -0 ; load acc b with BSP buffer and shift right -0
        b = #03FFFh & b ; mask out the TRISTATE bits with #03FFFh
        ;
        *ar2+ = data(#0bh) ; store B to out buffer and advance AR2 pointer
        TC = (@ar2 == #02000h) ; output buffer is 2k starting at 1800h
        if (TC) goto start ; restart if out buffer is at 1fffh
        goto bufull

```

APPLICATIONS INFORMATION

```
; -----dummy bsend return-----
bsend return_enable ;this is also a dummy return to define bsend
;in vector table file BVECTORS.ASM
; ----- end ISR -----

.copy "c:\diskplus\1403\s2k14ini.asm" ;initialize buffered serial port
.space 16*32 ;clear a chunk at the end to mark the end

;=====
;
; VECTORS
;
;=====

.sect "vectors" ;The vectors start here
.copy "c:\diskplus\1403\bvectors.asm" ;get BSP vectors

.sect "buffer" ;Set address of BSP buffer for clearing
.space 16*0x800
.sect "result" ;Set address of result for clearing
.space 16*0x800

.end

*****
* (C) COPYRIGHT TEXAS INSTRUMENTS, INC. 1996 *
*****
* File: s2k14ini.ASM BSP initialization code for the 'C54x DSKplus *
* for use with 1403A in standard mode *
* BSPC and SPC are the same in the 'C542 *
* BSPCE and SPCE seem the same in the 'C542 *
*****
.title "Buffered Serial Port Initialization Routine"
ON .set 1
OFF .set !ON
YES .set 1
NO .set !YES
BIT_8 .set 2
BIT_10 .set 1
BIT_12 .set 3
BIT_16 .set 0
GO .set 0x80

*****
* This is an example of how to initialize the Buffered Serial Port (BSP).
* The BSP is initialized to require an external CLK and FSX for
* operation. The data format is 16-bits, burst mode, with autobuffering
* enabled.
*
*****
*LTC1403 timing from LCC28 socket board with 10MHz crystal. *
*10MHz, divided from 40MHz, forced to CLKIN by 1403 board. *
*Horizontal scale is 25ns/chr or 100ns period at BCLKR. *
*Timing measured at DSP pins. Jxx pin labels for jumper cable. *
*BFSR Pin J1-20 ~\ _ _ _ /~~~~~\ _ _ _ /~~~~~*
*BCLKR Pin J1-14 _ /~\ _ /~\ _ /~\ _ /~\ _ /~\ _ /~\ _ /~\ _ /~\ _ /~\ _ /~\ _ /~\ _ /~\ _ /~\ _ /~\ _ /~\ _ /~\ _ /~\ _ /~\ *
*BDR Pin J1-26 _ --- _ ---<B13-B12-B11-B10-B09-B08-B07-B06-B05-B04-B03-B02-B01-B00>--- _ ---<B13-B12*
*CLKIN Pin J5-09 ~~~~~\ _ _ _ _ /~~~~~\ _ _ _ _ /~~~~~\ _ _ _ _ /~~~~~\ _ _ _ _ /~~~~~\
_ _ _ _ _ /~~~~~*
*C542 read 0 B13 B12 B11 B10 B09 B08 B07 B06 B05 B04 B03 B02 B01 B00 0 0 B13 B12*
```

APPLICATIONS INFORMATION

```

*
* negative edge BCLKR
* negative BFSR pulse
* no data shifted
* 1' cable from counter to CONV at DUT
* 2' cable from counter to CLK at DUT
*No right shift is needed to right justify the input data in the main program
*the two msbs should also be masked .....
*****
*
Loopback      .set    NO      ;(digital looback mode?)          DLB bit
Format        .set    BIT_16  ;(Data format? 16,12,10,8)        FO bit
IntSync       .set    NO      ;(internal Frame syncs generated?) TXM bit
IntCLK        .set    NO      ;(internal clks generated?)       MCM bit
BurstMode     .set    YES     ;(if BurstMode=NO, then Continuous) FSM bit
CLKDIV        .set    3       ;(3=default value, 1/4 CLOCKOUT)
PCM_Mode      .set    NO      ;(Turn on PCM mode?)
FS_polarity   .set    YES     ;(change polarity)YES=^^\_/^^, NO=_ _ _/\_ _ _
CLK_polarity  .set    NO      ;(change polarity)for BCLKR YES=_/^, NO=-\ _
Frame_ignore  .set    !YES    ;(inverted !YES -ignores frame)
XMTautobuf   .set    NO      ;(transmit autobuffering)
RCVautobuf   .set    YES     ;(receive autobuffering)
XMThalt      .set    NO      ;(transmit buff halt if XMT buff is full)
RCVhalt      .set    NO      ;(receive buff halt if RCV buff is full)
XMTbufAddr   .set    0x800    ;(address of transmit buffer)
XMTbufSize   .set    0x000    ;(length of transmit buffer)
RCVbufAddr   .set    0x800    ;(address of receive buffer)
RCVbufSize   .set    0x800    ;(length of receive buffer)works up to 800
*
* See notes in the 'C54x CPU and Peripherals Reference Guide on setting up
* valid buffer start and length values. Page 9-44
*
*
*****
    .eval ((Loopback >> 1)|((Format & 2)<<1)|((BurstMode <<3)|((IntCLK <<4)|((IntSync <<5)) ,SPCval
    .eval ((CLKDIV)|(FS_polarity <<5)|((CLK_polarity<<6)|((Format & 1)<<7)|((Frame_ignore<<8)|((PCM_Mode<<9))),SPCEval
    .eval (SPCEval|XMTautobuf<<10)|XMThalt<<12)|RCVautobuf<<13)|RCVhalt<<15)), SPCEval

sineinit:
    bspc = #SPCval      ; places buffered serial port in reset
    ifr = #10h         ; clear interrupt flags
    imr = #210h        ; Enable HPINT,enable BRINT0
    intm = 0           ; all unmasked interrupts are enabled.
    bspce = #SPCEval   ; programs BSPCE and ABU
    axr = #XMTbufAddr  ; initializes transmit buffer start address
    bkr = #RCVbufSize  ; initializes receive buffer size
    arr = #RCVbufAddr  ; initializes receive buffer start address
    bkr = #RCVbufSize  ; initializes receive buffer size
    bspc = #(SPCval | GO) ; bring buffered serial port out of reset
    return             ;for transmit and receive because GO=0xC0

; *****
; File: BVECTORS.ASM -> Vector Table for the 'C54x DSKplus          10.Jul.96
;
;           BSP vectors and Debugger vectors
;           TDM vectors just return
; *****
; The vectors in this table can be configured for processing external and
; internal software interrupts. The DSKplus debugger uses four interrupt
; vectors. These are RESET, TRAP2, INT2, and HPIINT.

```

APPLICATIONS INFORMATION

```

; * DO NOT MODIFY THESE FOUR VECTORS IF YOU PLAN TO USE THE DEBUGGER *
; All other vector locations are free to use. When programming always be sure
; the HPIINT bit is unmasked (IMR=200h) to allow the communications kernel and
; host PC interact. INT2 should normally be masked (IMR(bit 2) = 0) so that the
; DSP will not interrupt itself during a HINT. HINT is tied to INT2 externally.
;
;
;
        .title "Vector Table"
        .mmregs

reset   goto #80h           ;00; RESET * DO NOT MODIFY IF USING DEBUGGER *
        nop
        nop
nmi     return_enable      ;04; non-maskable external interrupt
        nop
        nop
        nop
trap2   goto #88h           ;08; trap2 * DO NOT MODIFY IF USING DEBUGGER *
        nop
        nop
        .space 52*16       ;0C-3F: vectors for software interrupts 18-30
int0    return_enable      ;40; external interrupt int0
        nop
        nop
        nop
int1    return_enable      ;44; external interrupt int1
        nop
        nop
        nop
int2    return_enable      ;48; external interrupt int2
        nop
        nop
        nop
tint    return_enable      ;4C; internal timer interrupt
        nop
        nop
        nop
brint   goto breceive      ;50; BSP receive interrupt
        nop
        nop
        nop
bxint   goto bsend         ;54; BSP transmit interrupt
        nop
        nop
        nop
trint   return_enable      ;58; TDM receive interrupt
        nop
        nop
        nop
txint   return_enable      ;5C; TDM transmit interrupt
        nop
        nop
        nop
int3    return_enable      ;60; external interrupt int3
        nop
        nop
        nop
hpiint  dgoto #0e4h        ;64; HPIint * DO NOT MODIFY IF USING DEBUGGER *
        nop
        nop
        .space 24*16      ;68-7F; reserved area

```

PACKAGE DESCRIPTION

Please refer to <http://www.linear.com/product/LTC1403#packaging> for the most recent package drawings.

MSE Package 10-Lead Plastic MSOP, Exposed Die Pad (Reference LTC DWG # 05-08-1664 Rev I)

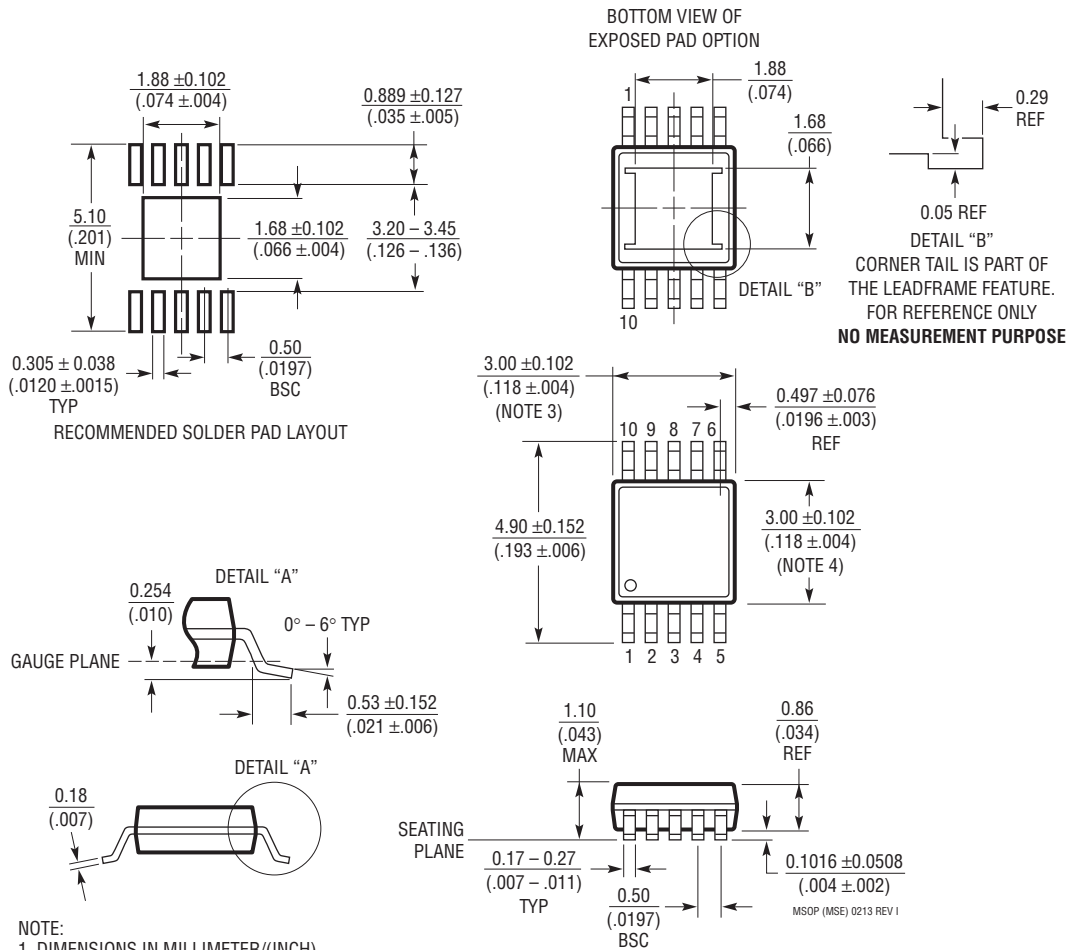

- NOTE:
- DIMENSIONS IN MILLIMETER/(INCH)
 - DRAWING NOT TO SCALE
 - DIMENSION DOES NOT INCLUDE MOLD FLASH, PROTRUSIONS OR GATE BURRS. MOLD FLASH, PROTRUSIONS OR GATE BURRS SHALL NOT EXCEED 0.152mm (.006") PER SIDE
 - DIMENSION DOES NOT INCLUDE INTERLEAD FLASH OR PROTRUSIONS. INTERLEAD FLASH OR PROTRUSIONS SHALL NOT EXCEED 0.152mm (.006") PER SIDE
 - LEAD COPLANARITY (BOTTOM OF LEADS AFTER FORMING) SHALL BE 0.102mm (.004") MAX
 - EXPOSED PAD DIMENSION DOES INCLUDE MOLD FLASH. MOLD FLASH ON E-PAD SHALL NOT EXCEED 0.254mm (.010") PER SIDE.

REVISION HISTORY (Revision history begins at Rev C)

REV	DATE	DESCRIPTION	PAGE NUMBER
C	02/17	Updated Timing Characteristics Including t_{CONV} Minimum Conversion Time of 17 Clocks	5, 9, 14, 15

LTC1403/LTC1403A

RELATED PARTS

PART NUMBER	DESCRIPTION	COMMENTS
ADCs		
LTC1608	16-Bit, 500ksps Parallel ADC	±5V Supply, ±2.5V Span, 90dB SINAD
LTC1604	16-Bit, 333ksps Parallel ADC	±5V Supply, ±2.5V Span, 90dB SINAD
LTC1609	16-Bit, 250ksps Serial ADC	5V, Configurable Bipolar/Unipolar Inputs
LTC1411	14-Bit, 2.5Msps Parallel ADC	5V, Selectable Spans, 80dB SINAD
LTC1414	14-Bit, 2.2Msps Parallel ADC	±5V Supply, ±2.5V Span, 78dB SINAD
LTC1407/LTC1407A	12-/14-Bit, 3Msps Simultaneous Sampling ADC	3V, 2-Channel Differential, 14mW, MSOP Package
LTC1420	12-Bit, 10Msps Parallel ADC	5V, Selectable Spans, 72dB SINAD
LTC1405	12-Bit, 5Msps Parallel ADC	5V, Selectable Spans, 115mW
LTC1412	12-Bit, 3Msps Parallel ADC	±5V Supply, ±2.5V Span, 72dB SINAD
LTC1402	12-Bit, 2.2Msps Serial ADC	5V or ±5V Supply, 4.096V or ±2.5V Span
LTC1864/LTC1865	16-Bit, 250ksps Serial ADC	5V Supply, 1 and 2 Channel, 4.3mW, MSOP Package
DACs		
LTC1666/LTC1667/LTC1668	12-/14-/16-Bit, 50Msps DACs	87dB SFDR, 20ns Settling Time
LTC1592	16-Bit, Serial SoftSpan™ I _{OUT} DAC	±1LSB INL/DNL, Software Selectable Spans
References		
LT®1790-2.5	Micropower Series Reference in SOT-23	0.05% Initial Accuracy, 10ppm Drift
LT1461-2.5	Precision Voltage Reference	0.04% Initial Accuracy, 3ppm Drift
LT1460-2.5	Micropower Series Voltage Reference	0.1% Initial Accuracy, 10ppm Drift