

FRONT VIEW WITH COVER REMOVED AND BACK PANEL SHOWN

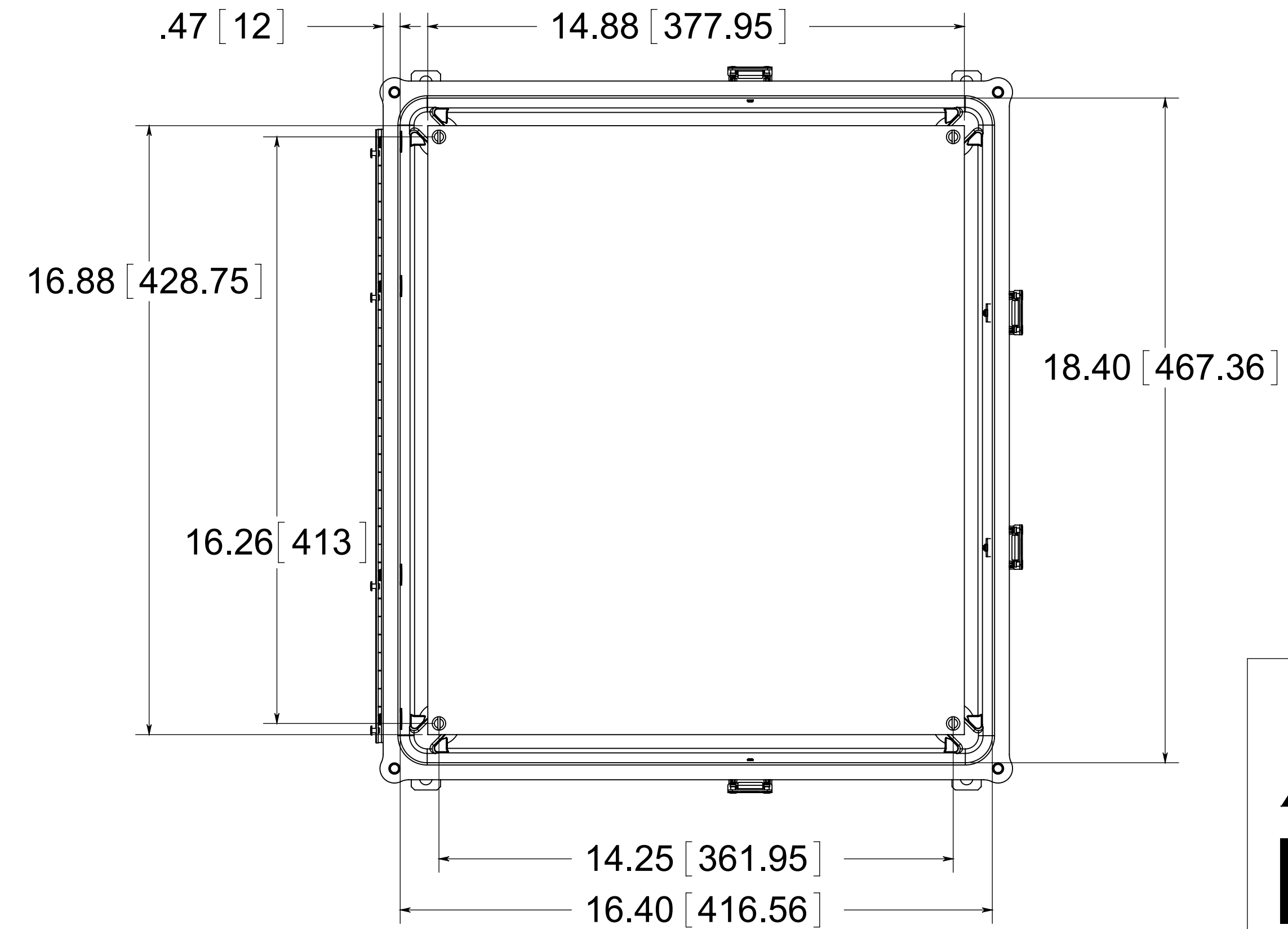
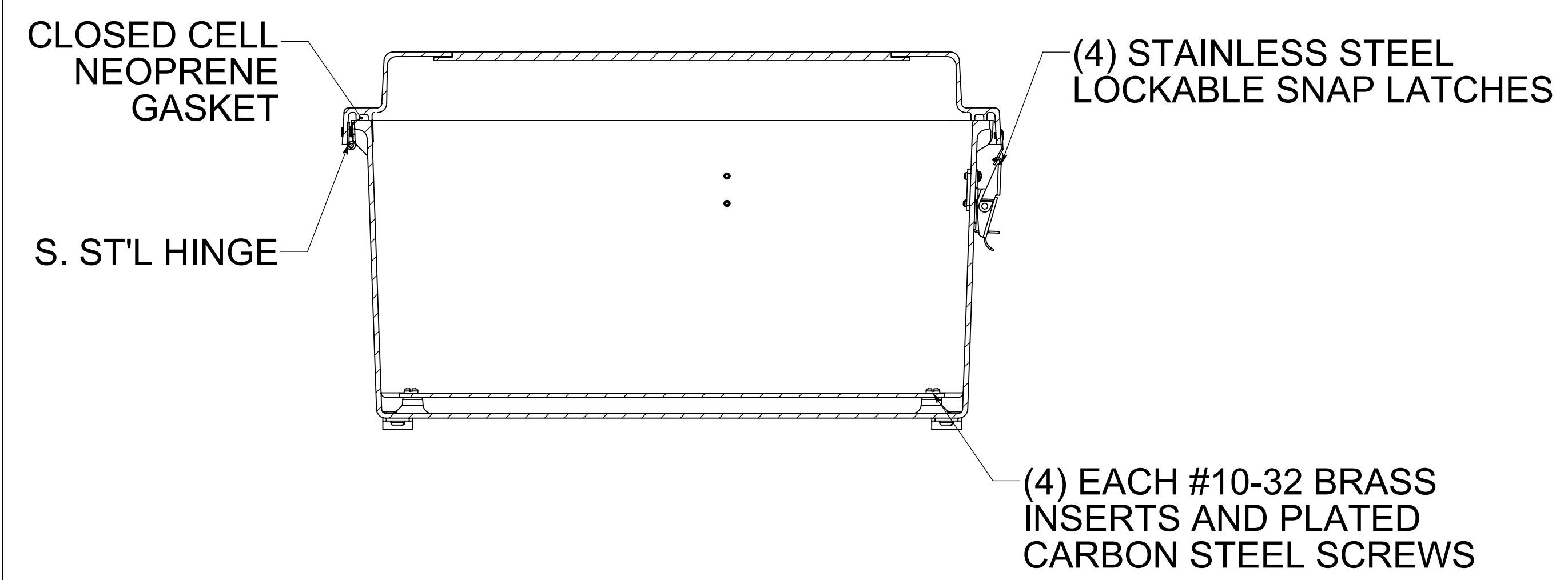

MATERIAL:
BOX- COMPRESSION MOLDED FIBERGLASS REINFORCED POLYESTER
COVER- COMPRESSION MOLDED FIBERGLASS REINFORCED POLYESTER
WINDOWS- POLYCARBONATE

PART No. PJ18168RLW
for more information visit www.hammfg.com
Data subject to change without notice
Drawing Not to Scale