

## Features

- Conversion Gain:
  - $T_x = 3$  dB
  - $R_x = 11$  dB
- Receive:
  - Noise Figure = 3 dB
  - IIP3 = +5 dBm
- Transmit: IM3 = -40 dBc @ 0 dBm
- LO: 8 - 10 GHz & 0 dBm Drive
- Wide IF Bandwidth = 0.1 - 6.0 GHz
- Single 5 Volt DC Bias, 180 mA
- Lead-Free 4 mm 24-lead PQFN Package
- Halogen-Free "Green" Mold Compound
- RoHS\* Compliant and 260°C Reflow Compatible

## Description

The MAMF-011024 is a 21 - 27 GHz transceiver IC. It integrates an LNA, PA,  $T_x/R_x$  switch, bi-directional mixer, filtering, and LO frequency x2 multiplier with amplification. This device is assembled in a lead-free 4 mm 24 lead PQFN surface mount plastic package.

This transceiver operates either in receive or in transmit TDD (Time Division Duplex) mode. Receive and transmit circuitry can be turned off during transmit and receive, respectively. The  $T_x/R_x$  switch can be operated independently of the power up timing. It is powered from a single positive 5 V bias.

The MAMF-011024 is ideally suited for unlicensed 24 GHz ISM band applications.

## Ordering Information<sup>1,2</sup>

Part Number	Package
MAMF-011024 -TR0500	500 piece reel
MAMF-011024 -SMB	Sample Test Board

1. Reference Application Note M513 for reel size information.
2. All sample boards include 3 loose parts.

\*Restrictions on Hazardous Substances,  
European Union Directive 2011/65/EU.

## Functional Schematic

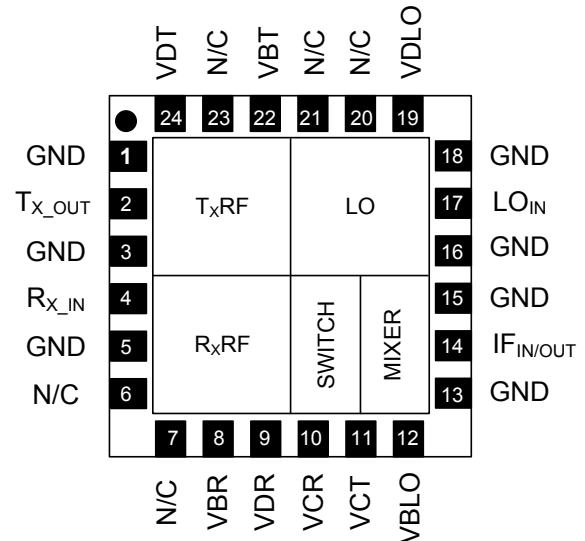

## Pin Configuration<sup>3</sup>

Pin No.	Description	Pin No.	Description
1	Ground	13	Ground
2	Transmit Output	14	IF Input / Output
3	Ground	15	Ground
4	Receive Input	16	Ground
5	Ground	17	LO Input
6	No Connection	18	Ground
7	No Connection	19	LO Drain Voltage
8	$R_x$ Bias Adjust	20	No Connection
9	$R_x$ Drain Voltage	21	No Connection
10	$R_x$ Switch Control	22	$T_x$ Bias Adjust
11	$T_x$ Switch Control	23	No Connection
12	LO Bias Adjust	24	$T_x$ Drain Voltage
		25 <sup>4</sup>	Ground

3. MACOM recommends connecting all "No Connection" pins to ground.
4. The exposed pad centered on the package bottom must be connected to RF, DC and thermal ground.

**Electrical Specifications:  $T_A = 25^\circ\text{C}$ ,  $R_F = 24\text{ GHz}$ ,  $I_F = 5.6\text{ GHz}$ ,  $L_O = 9.2\text{ GHz}$ ,  $0\text{ dBm}$ ,  $Z_0 = 50\ \Omega$ ,  $V_{DT} = V_{DR} = V_{DLO} = 5\text{ V}$ , Control / Bias Adjust Voltages<sup>5</sup> =  $0 / 5\text{ V}$**

Parameter	Test Conditions	Units	Min.	Typ.	Max.
LO: Drive Power	—	dBm	—	0	—
LO: Return Loss	—	dB	—	12	—
R <sub>X</sub> : Down Conversion Gain	—	dB	9	11	—
R <sub>X</sub> : Noise Figure	—	dB	—	3	—
R <sub>X</sub> : Return Loss	—	dB	—	11	—
R <sub>X</sub> : Input IP3	—	dBm	—	+5	—
R <sub>X</sub> : LO Isolation	LO to IF port LO Frequency 2xLO Frequency 3xLO Frequency	dB	—	22 33 55	—
T <sub>X</sub> : Up Conversion Gain	—	dB	1	3	—
T <sub>X</sub> : Output Noise	—	dBm/Hz	—	-85	—
T <sub>X</sub> : Return Loss	—	dB	—	15	—
T <sub>X</sub> : Output IM3	+5 dBm P <sub>OUT</sub>	dBc	—	-40	—
T <sub>X</sub> : LO Isolation	LO to T <sub>X</sub> port LO Frequency 2xLO Frequency 3xLO Frequency	dB	—	48 20 25	—
IF: Return Loss	—	dB	—	7	—
Isolation	T <sub>X</sub> Mode, R <sub>X</sub> to IF R <sub>X</sub> Mode, T <sub>X</sub> to IF	dB	—	69 58	—
Current (sum of all DC currents)	T <sub>X</sub> Mode R <sub>X</sub> Mode Standby Mode	mA	110 120 —	150 160 <1	170 180 —

5. See Truth Table.

## Absolute Maximum Ratings<sup>6,7</sup>

Parameter	Absolute Maximum
Input Power (R <sub>x</sub> )	+15 dBm
Input Power (LO, IF)	+10 dBm
Voltage	6 V
Junction Temperature	150°C
Operating Temperature	-40°C to +85°C
Storage Temperature	-65°C to +150°C

6. Exceeding any one or combination of these limits may cause permanent damage to this device.  
7. MACOM does not recommend sustained operation near these survivability limits.

## Handling Procedures

Please observe the following precautions to avoid damage:

## Static Sensitivity

Gallium Arsenide Integrated Circuits are sensitive to electrostatic discharge (ESD) and can be damaged by static electricity. Proper ESD control techniques should be used when handling these devices.

## Truth Table

Mode / Pin	VBLO (V)	VBT (V)	VBR (V)	VCT (V)	VCR (V)
R <sub>x</sub>	+5	0	+5	0	+5
T <sub>x</sub>	+5	+5	0	+5	0
Standby	0	0	0	0	0

The MAMF-011024 is designed to be easy to use yet high performance. The ultra small size and simple bias allow easy placement on any system board. It requires no matching or external tuning elements; all RF ports are matched to 50  $\Omega$ .

The MAMF-011024 requires only a single +5 V power supply to operate. All VDX and VBX lines can be tied to the +5 V (with appropriate bypass capacitors) for simple operation. See the Truth Table for T<sub>x</sub>/R<sub>x</sub>/Standby modes of operation.

## Evaluation Board

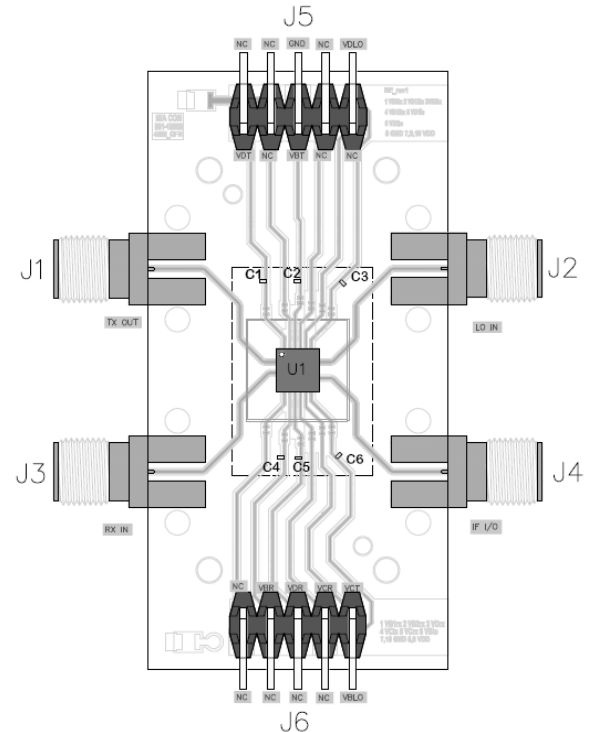

## Parts List

Component	Value	Package
C1 - C6	0.22 $\mu$ F	0201

## Application Schematic

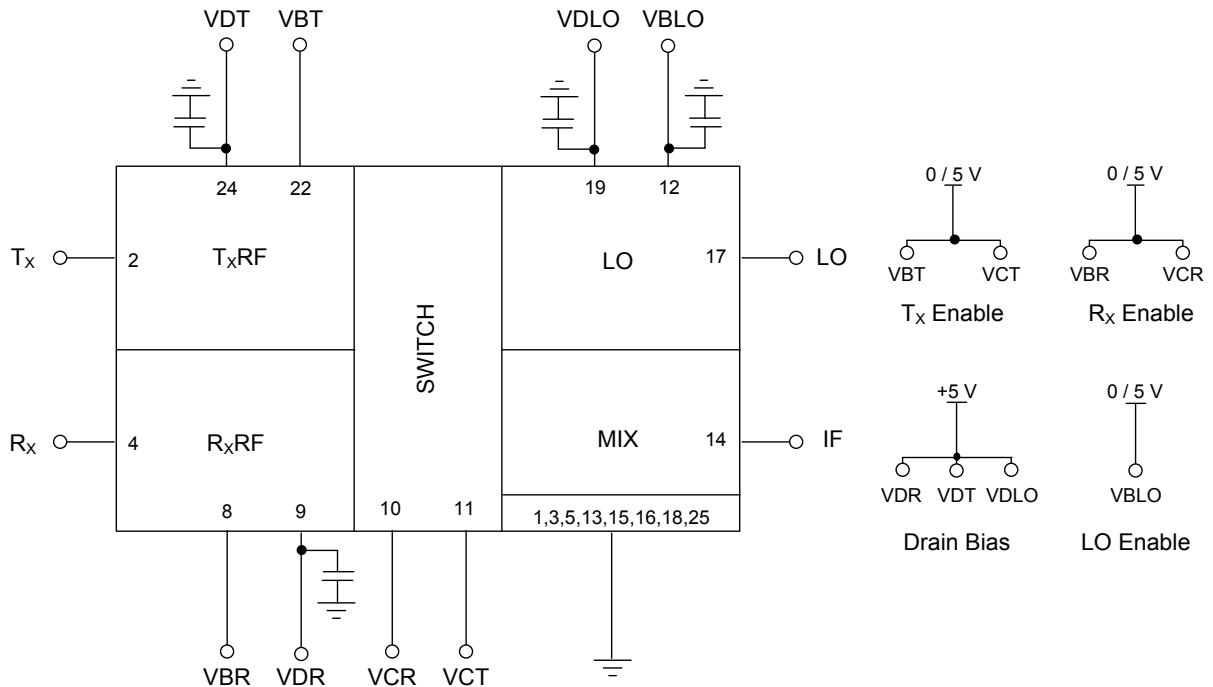

## R<sub>x</sub> (Receive) Typical Performance for Down-Conversion

**Gain**

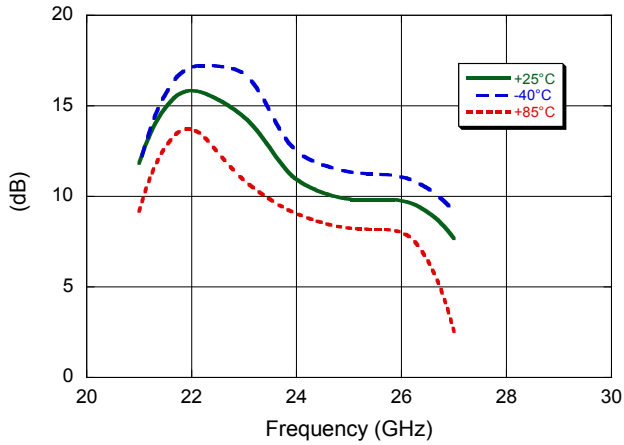

**Input IP3**

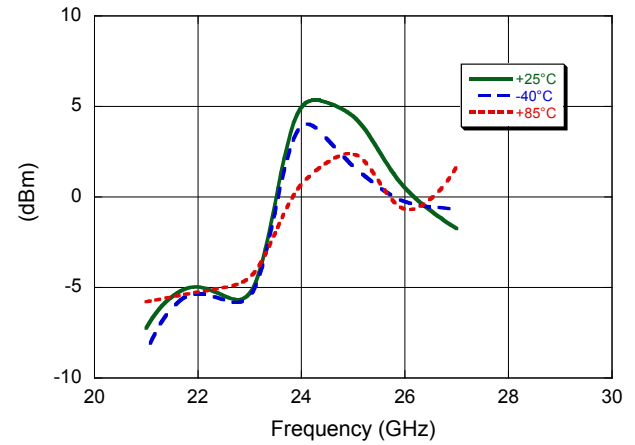

**Noise Figure**

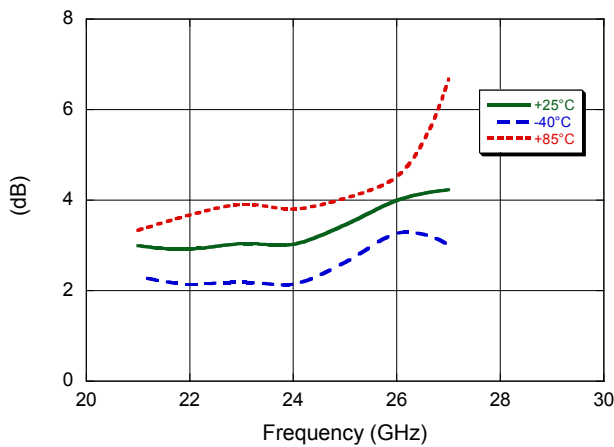

**Input IP3 vs. IF Frequency, LO = 0 dBm**

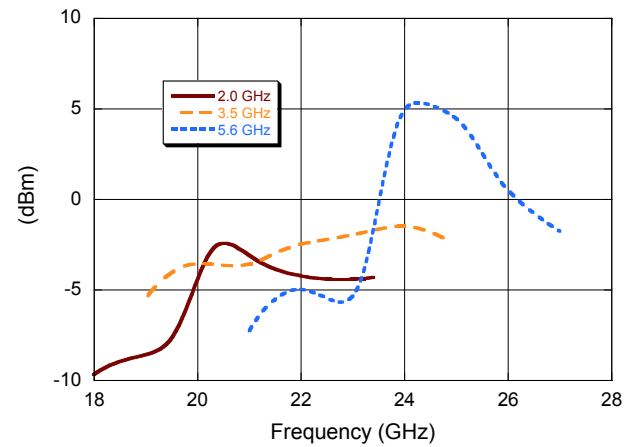

**Isolation LO to IF**

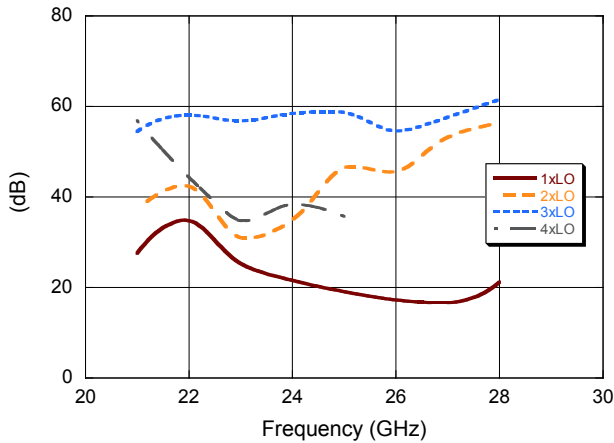

**Conversion Gain vs. IF Frequency**

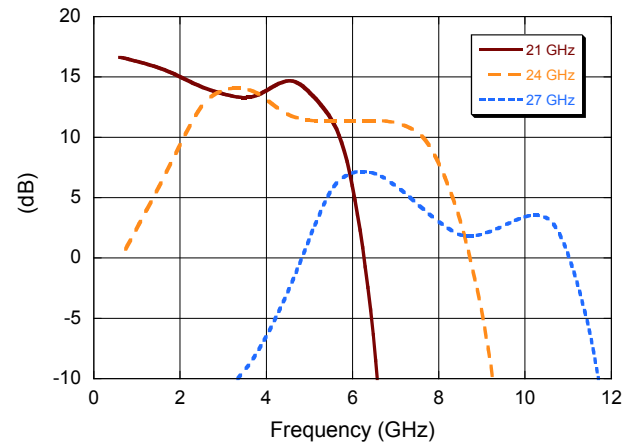

## T<sub>x</sub> (Transmit) Typical Performance for Up-Conversion

**Gain**

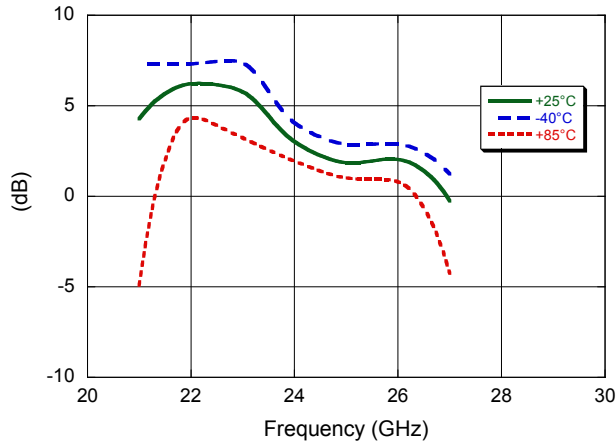

**Output IM3 @ 5 dBm**

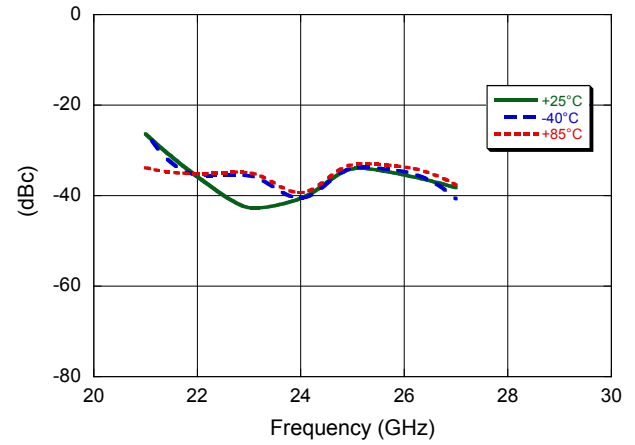

**Output Noise**

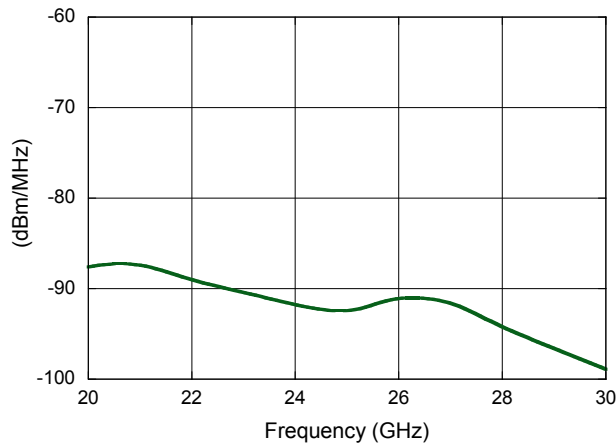

**Output IM3 @ LO Input Power**

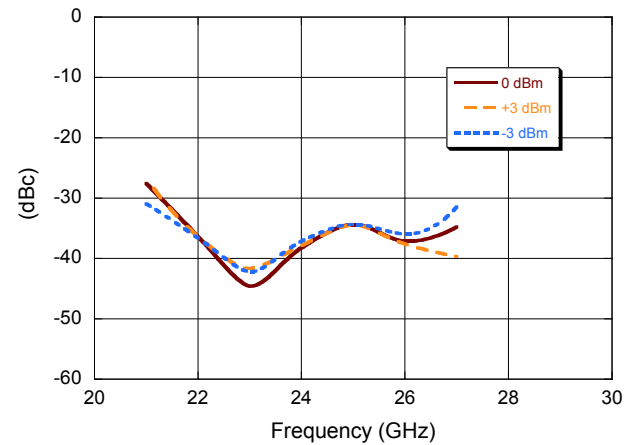

**Isolation LO to T<sub>x</sub>**

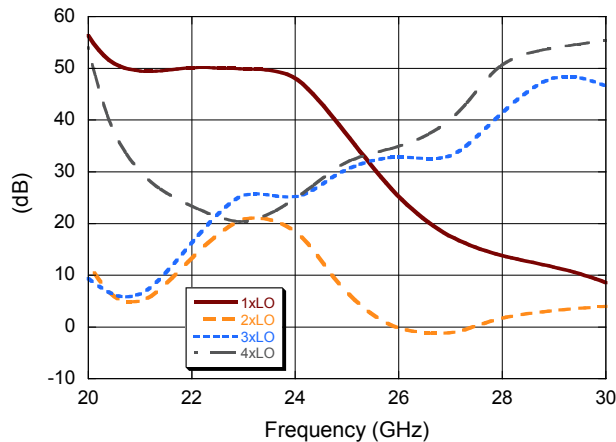

**Conversion Gain vs. IF Frequency**

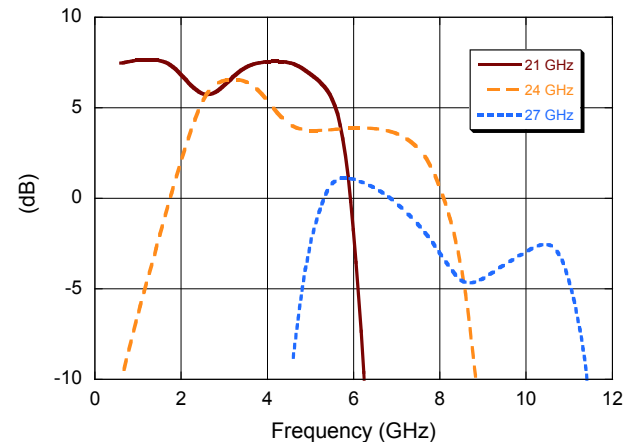

## Typical Performance

**R<sub>x</sub>/T<sub>x</sub> Input Return Loss**

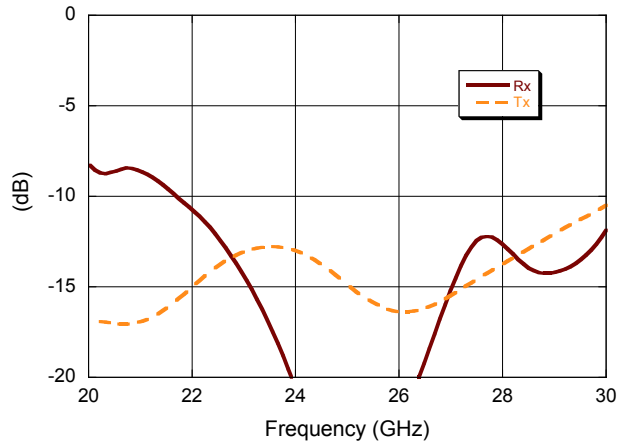

**LO Return Loss vs. LO Frequency**

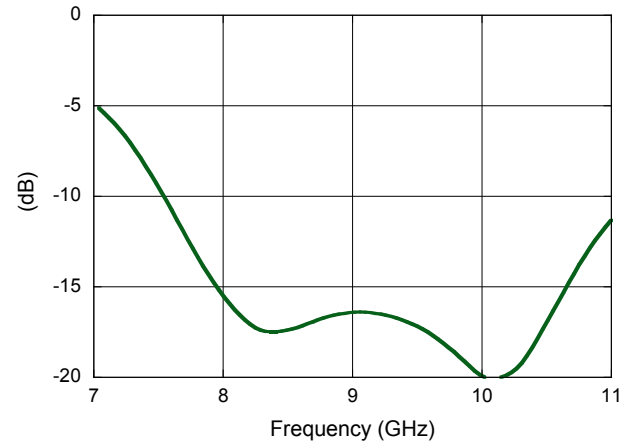

**IF Return Loss vs. IF Frequency**

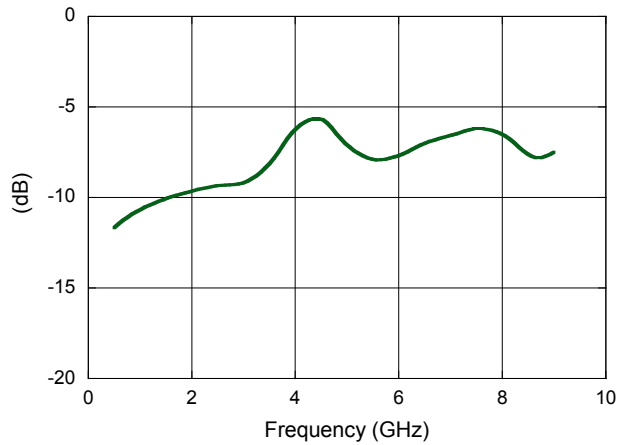

**T<sub>x</sub> Output Spectrum**

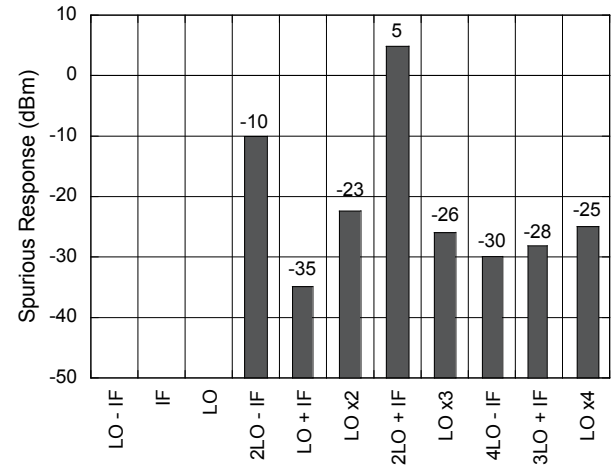

**R<sub>x</sub> Conversion Gain vs. LO Drive**

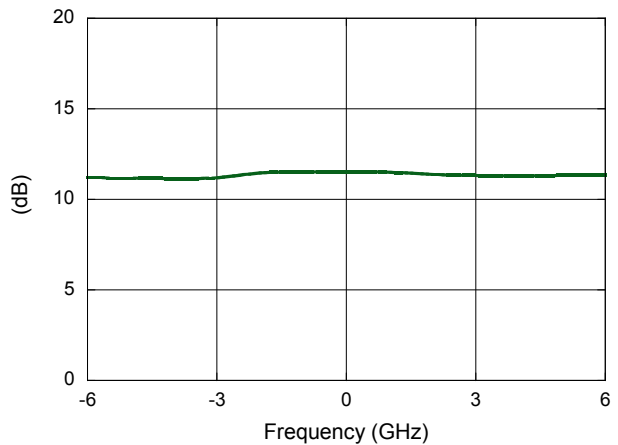

**T<sub>x</sub> Conversion Gain vs. LO Drive**

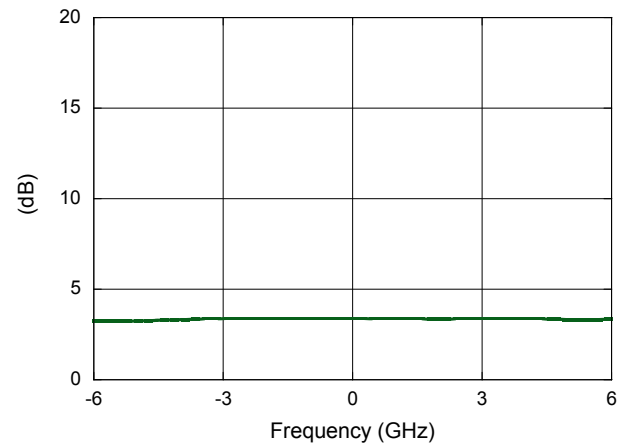

## Lead-Free 4 mm 24-Lead PQFN<sup>†</sup>

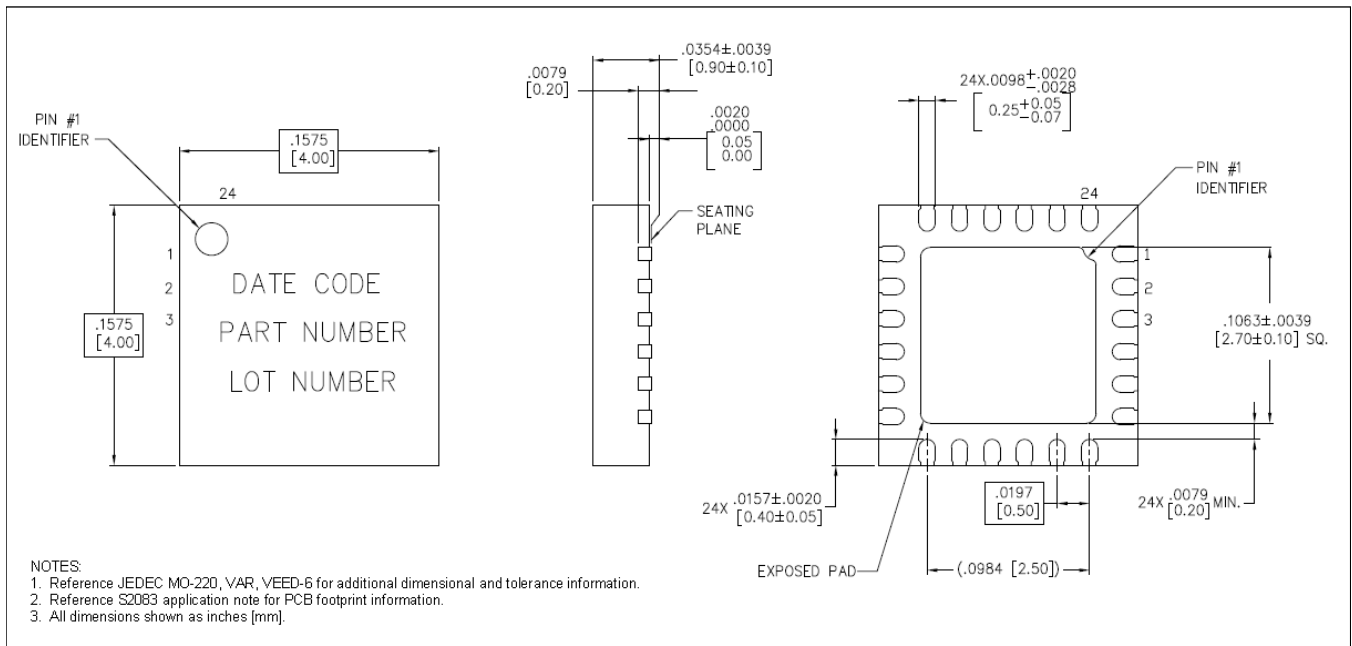

<sup>†</sup> Reference Application Note S2083 for lead-free solder reflow recommendations.  
Meets JEDEC moisture sensitivity level 1 requirements.  
Plating is NiPdAuAg.