

LOC	DIST	REVISIONS					
		P	LTN	DESCRIPTION	DATE	DWN	APVD
ES	00	F		REVISED 2-2 BY CUSTOMER	09MAR2015	CZ	SZ

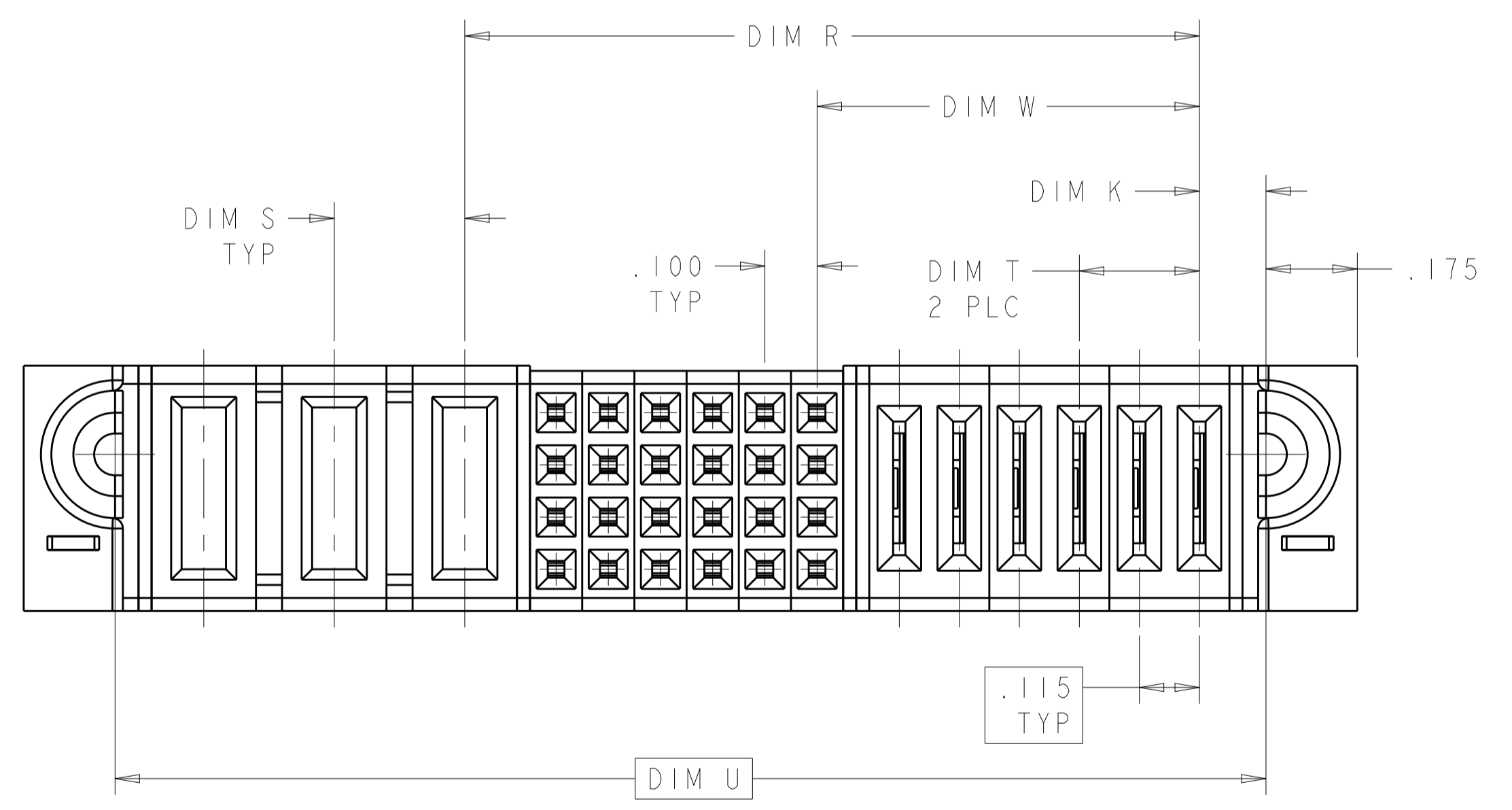

- ① "AMP", TRADEMARK, PART NUMBER AND DATE CODE TO BE MARKED IN AREA SHOWN
- ② MATERIAL: HOUSING - GLASS FILLED HIGH TEMP THERMO PLASTIC, UL94 V-0, BLACK
SIGNAL CONTACT - HIGH CONDUCTIVITY COPPER ALLOY
POWER CONTACT - HIGH CONDUCTIVITY COPPER ALLOY
- ③ CONTACT PLATING: NOBLE METAL PLATING ON CONTACT FUNCTIONAL AREA OF POWER AND SIGNAL CONTACTS
- ④ MECHANICAL CONNECTOR KEEP OUT ZONE
- ⑤ DATUM AND BASIC DIMENSIONS ESTABLISHED BY CUSTOMER
- ⑥ PCB - ALL HOLE DIAMETERS ARE FINISHED HOLE SIZES
- ⑦ PCB - .0453 ± .0010 DRILLED HOLES PLATED WITH .0003 MIN Sn OVER .001 TO .003 CU PLATING TO ACHIEVE A .040 ± .003 DIA HOLE
- ⑧ DIM W & DIM R ARE APPLICABLE TO P+S+P CONFIGURATION.
- ⑨ FOR P/N 6450850-3, -11, THE VARIABLE DIMENSIONS PLEASE SEE SHEET 2.
- ⑩ VARIABLE DIMENSIONS SHOW ON TABLE OR PART VIEW

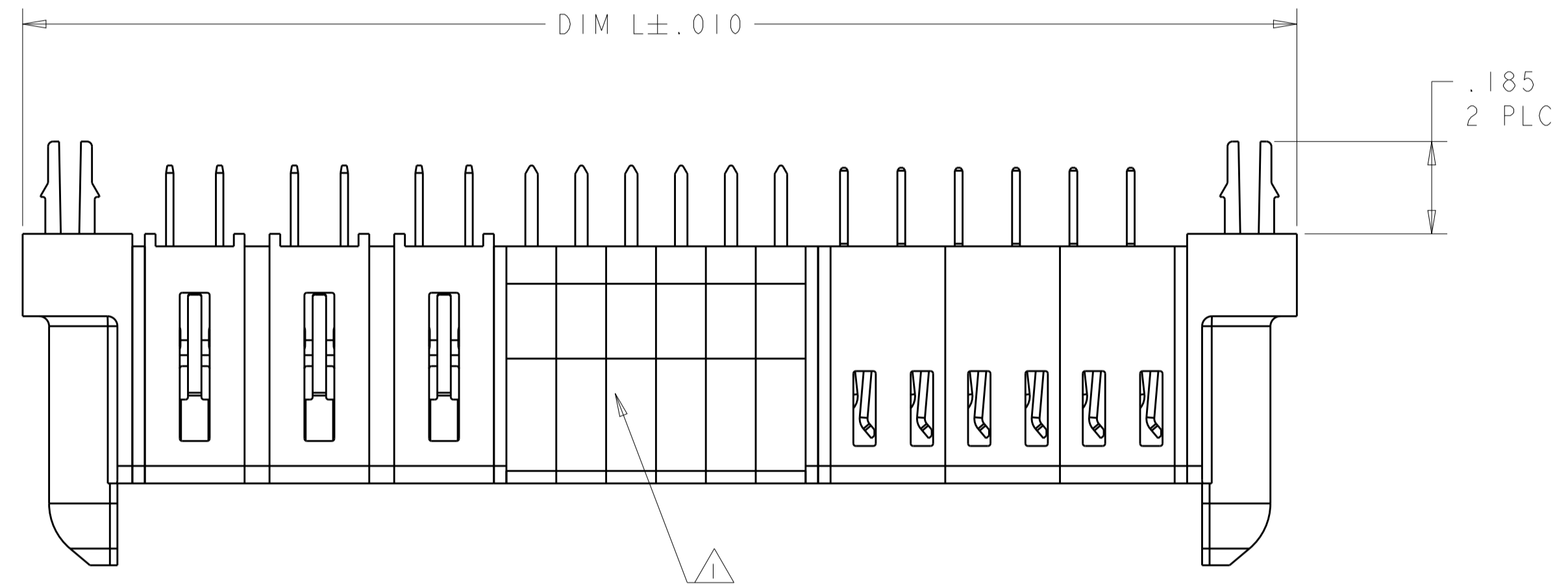
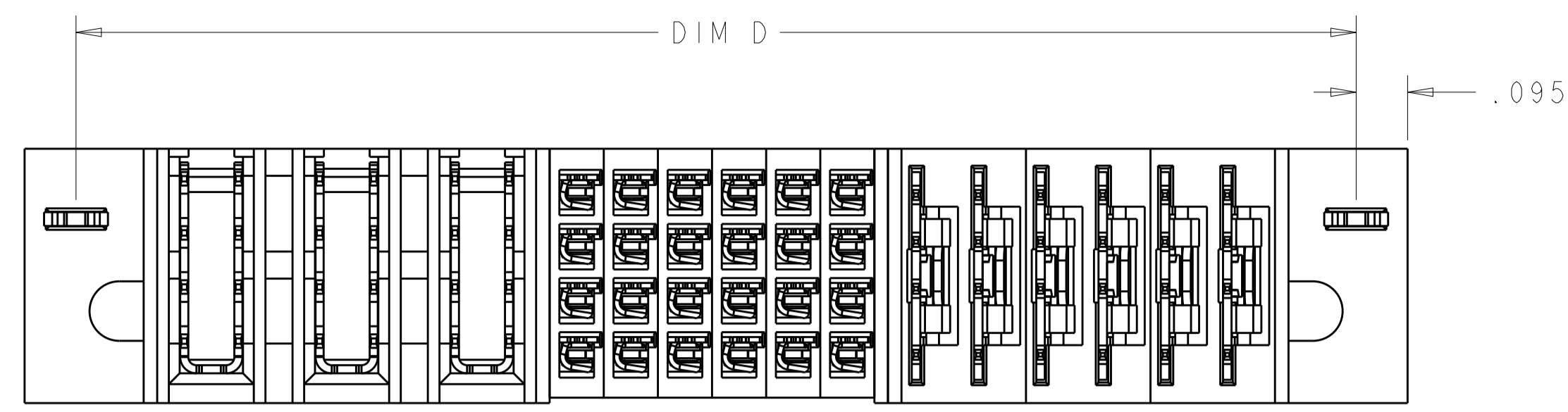
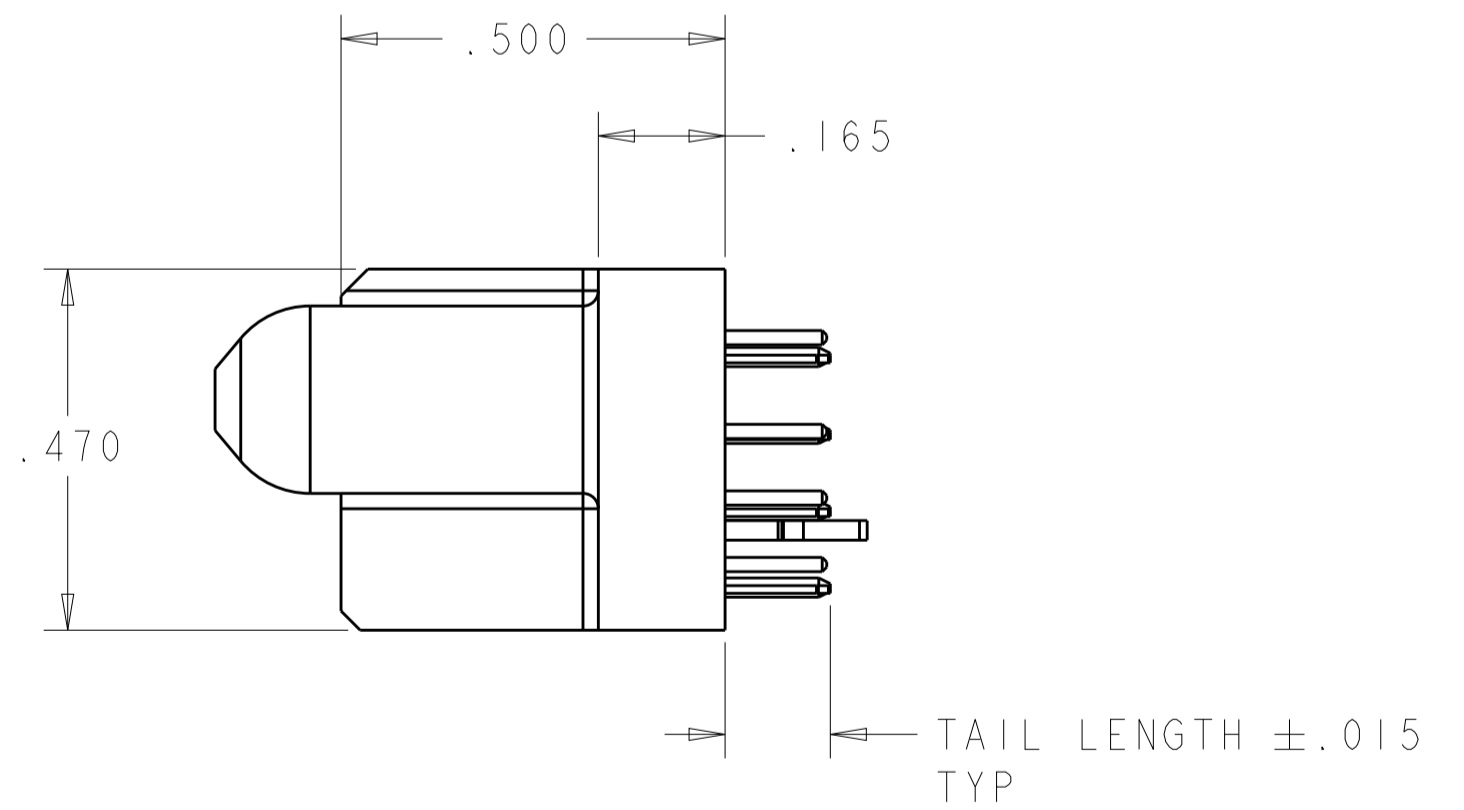

THIS DRAWING IS A CONTROLLED DOCUMENT.		DWN S. ZHAO 20SEP2007	TE Connectivity												
DIMENSIONS: INCHES		CHK S. ZHAO 20SEP2007													
TOLERANCES UNLESS OTHERWISE SPECIFIED:		APVD S. YAO	NAME VERTICAL RECEPTACLE ASSEMBLY, WITH GUIDES MULTI-BEAM XLE												
<table border="1"> <tr> <td>0 PLC</td> <td>±</td> </tr> <tr> <td>1 PLC</td> <td>±.01</td> </tr> <tr> <td>2 PLC</td> <td>±.01</td> </tr> <tr> <td>3 PLC</td> <td>±.005</td> </tr> <tr> <td>4 PLC</td> <td>±.0020</td> </tr> <tr> <td>ANGLES</td> <td>±.7°</td> </tr> </table>		0 PLC	±	1 PLC	±.01	2 PLC	±.01	3 PLC	±.005	4 PLC	±.0020	ANGLES	±.7°	PRODUCT SPEC 108-1973	SIZE A1
0 PLC	±														
1 PLC	±.01														
2 PLC	±.01														
3 PLC	±.005														
4 PLC	±.0020														
ANGLES	±.7°														
MATERIAL		APPLICATION SPEC 114-13038	CAGE CODE DRAWING NO C=6450850												
FINISH		WEIGHT	RESTRICTED TO												
CUSTOMER DRAWING		SCALE 4:1	SHEET 1 OF 8												
		REV F													

LOC		DIST		REVISIONS				
ES	00	P	LTN	DESCRIPTION	DATE	DMN	APVD	
-	-	-	-	SEE SHEET 1	-	-	-	

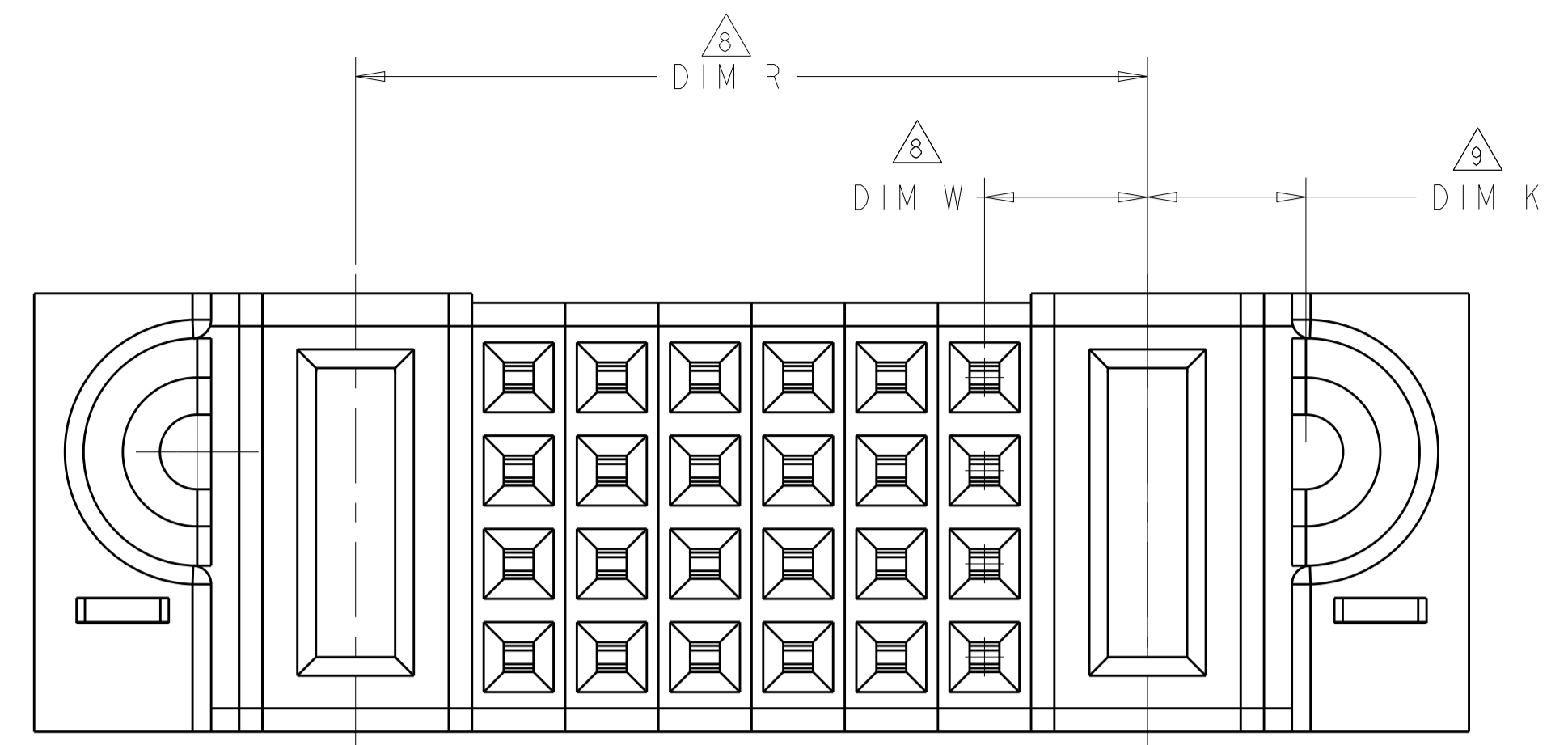

FOR P/N 6450850-3,-11, THE OTHER DIMENSIONS PLEASE SEE THE TABLE OF SHEET 1.

Δ	Δ	2.1275	1.1025	4.590	4.240	4.400	.1025	9LP + 36S + IP + 16LP	2-6450850-2
.300	.250	1.275	.800	2.490	2.140	2.300	.195	3ACP + 16S + 3P	2-6450850-1
.230	.230	1.090	.7825	1.990	1.640	1.800	.1025	3LP + 12S + 4LP	2-6450850-0
.250	.250	1.150	.675	2.340	1.990	2.150	.170	3P + 16S + 3P	1-6450850-9
Δ	Δ	Δ	Δ	3.270	2.920	3.080	.170	5HDP + 24S + IP + 7LP	1-6450850-8
-	-	.500	.200	1.140	.790	.950	.145	IP + 8S + IP	1-6450850-7
.300	.250	1.250	.775	2.940	2.590	2.750	.170	3ACP + 16S + 5P	1-6450850-6
.200	.200	.800	.350	1.840	1.490	1.650	.145	2P + 16S + 3P	1-6450850-4
.250	.250	1.300	.925	2.740	2.390	2.550	.170	4P + 12S + 4P	1-6450850-3
-	-	.850	.175	1.540	1.190	1.350	.170 Δ	IP + 24S + IP	1-6450850-1
-	-	.850	.175	1.540	1.190	1.350	.170 Δ	IP + 24S + IP	6450850-3
.230	.250	1.4075	.7325	2.555	2.205	2.365	.1275	6LP + 24S + 3P	6450850-2
DIM T	DIM S	DIM R Δ	DIM W Δ	DIM L	DIM U	DIM D	DIM K	DESCRIPTION	PART NUMBER

THIS DRAWING IS A CONTROLLED DOCUMENT. DMN S.ZHAO 20SEP2007
 CHK S.ZHAO 20SEP2007

DIMENSIONS: INCHES TOLERANCES UNLESS OTHERWISE SPECIFIED:
 0 PLC ±.01
 1 PLC ±.01
 2 PLC ±.01
 3 PLC ±.005
 4 PLC ±.0020
 ANGLES ±.7°

MATERIAL: FINISH:

APVD S.YAO

PRODUCT SPEC: 108-1973
 APPLICATION SPEC: 114-13038

WEIGHT: CUSTOMER DRAWING

NAME: VERTICAL RECEPTACLE ASSEMBLY, WITH GUIDES MULTI-BEAM XLE

SIZE: A1 CAGE CODE: 00779 DRAWING NO: 6450850

RESTRICTED TO: SCALE: 4:1 SHEET 2 OF 8 REV F

TE Connectivity

LOC	DIST	REVISIONS			
P	LTN	DESCRIPTION	DATE	DMN	APVD
ES	00	SEE SHEET 1			

PART NUMBER	ROWS	POWER			SIGNAL					POWER						
		P3	P2	P1	6	5	4	3	2	1	LP6	LP5	LP4	LP3	LP2	LP1
6450850-2	D C B A	VM	VM	VM	E	E	E	E	E	E	E	LM	LM	LM	LM	LM
6LP + 24S + 3P																

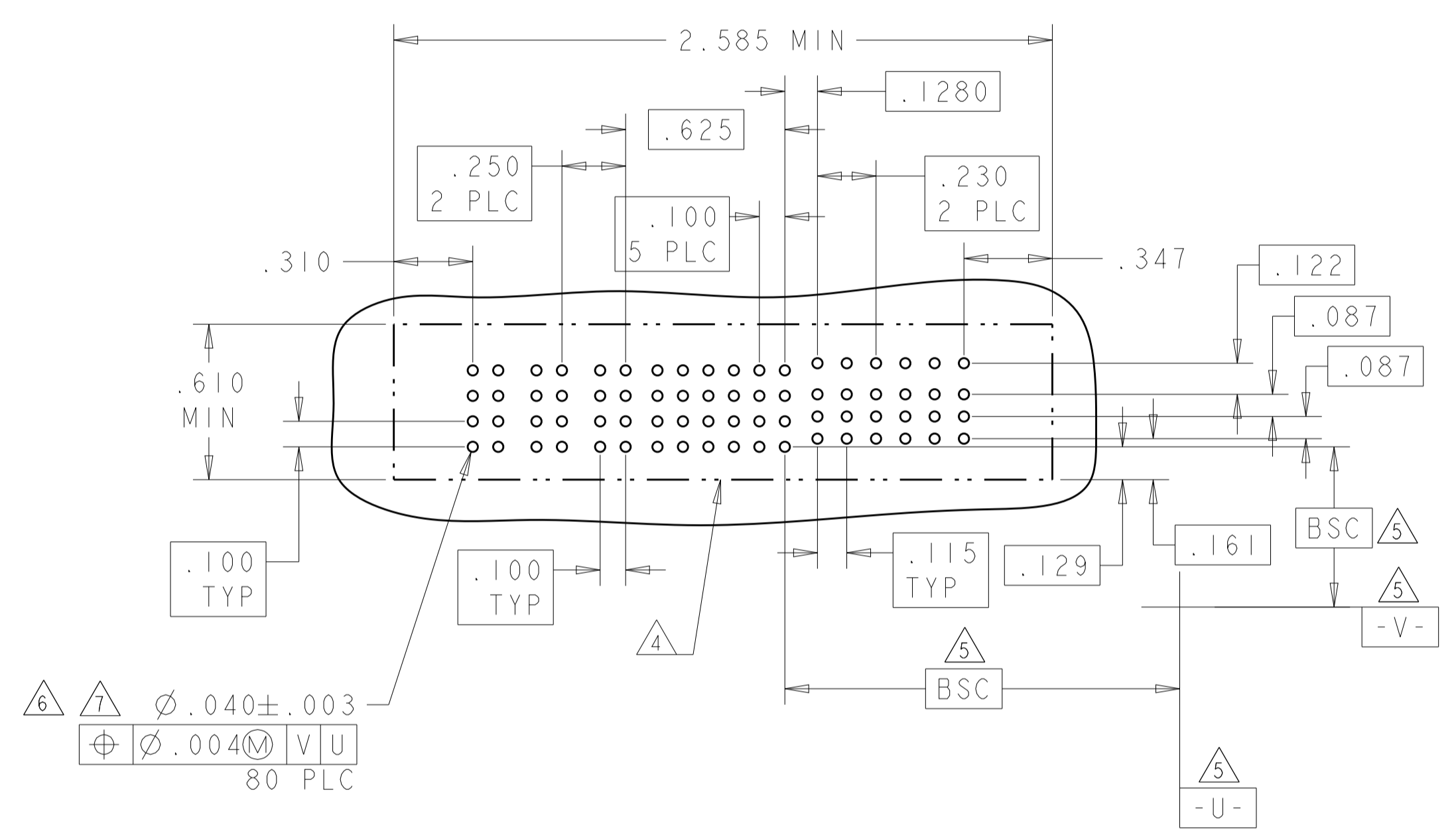

PART NUMBER	ROWS	POWER		SIGNAL					POWER			
		P2	P1	6	5	4	3	2	1	P1	P2	
6450850-3	D C B A	VM	VM	E	E	E	E	E	E	E	VM	VM
IP + 24S + IP												

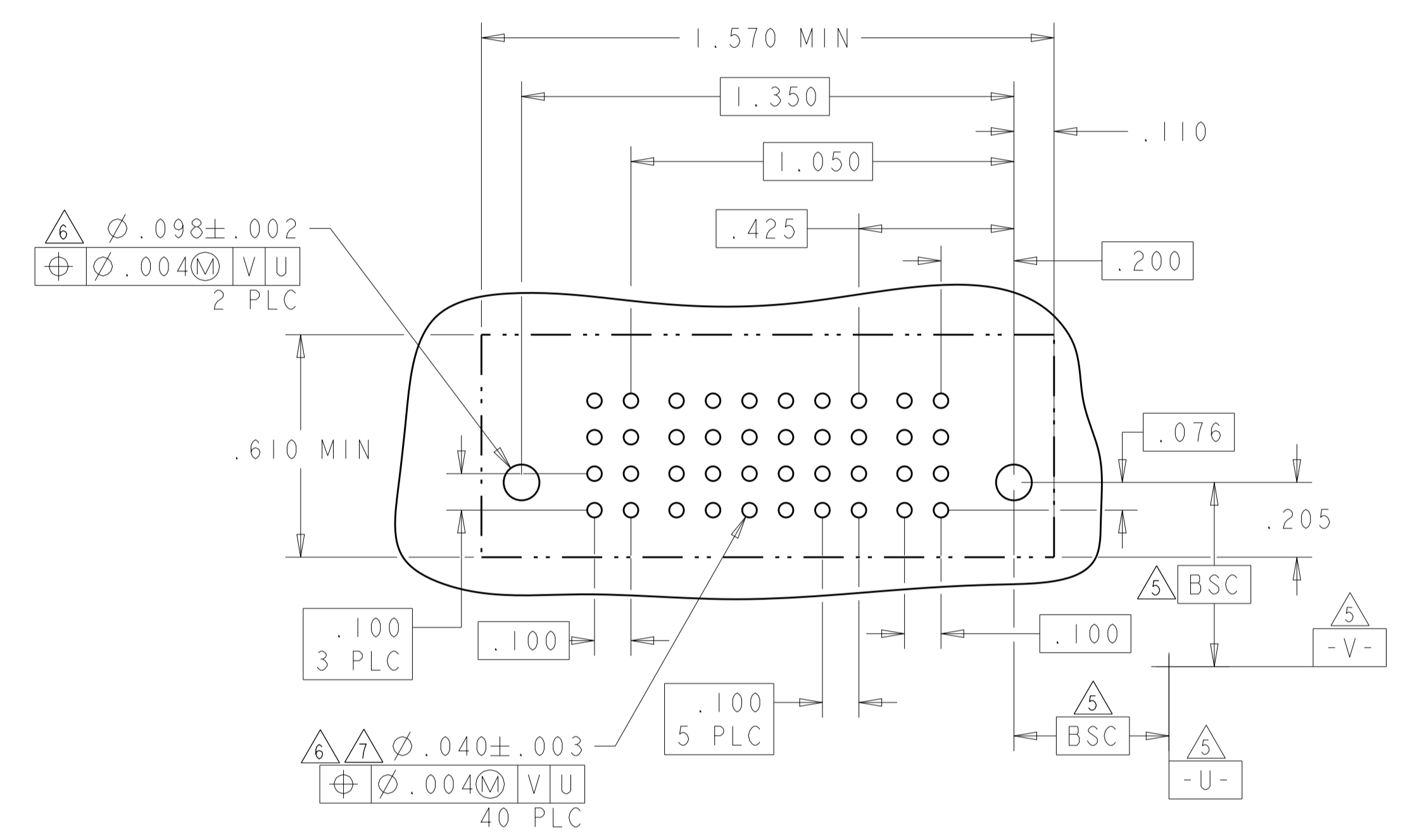

PART NUMBER	ROWS	POWER		SIGNAL					POWER			
		P2	P1	6	5	4	3	2	1	P1	P2	
1-6450850-1	D C B A	VM	VA	E	E	E	E	E	E	E	VA	VA
IP + 24S + IP												

LAYOUT OF 1-6450850-1 IS SAME AS 6450850-3.

LM	LOW POWER CONTACT .135" TAIL LENGTH
M	SIGNAL CONTACT .165" TAIL LENGTH
E	SIGNAL CONTACT .135" TAIL LENGTH
VO	POWER CONTACT, STD.165" TAIL LENGTH
VA	POWER CONTACT, MFBL.135" TAIL LENGTH
VM	POWER CONTACT, STD.135" TAIL LENGTH
CODE	DESCRIPTION
CONTACTS	

THIS DRAWING IS A CONTROLLED DOCUMENT.		DMN S.ZHAO 20SEP2007	STE TE Connectivity
DIMENSIONS: INCHES		CHK S.ZHAO 20SEP2007	
TOLERANCES UNLESS OTHERWISE SPECIFIED:		APVD S.YAO	NAME VERTICAL RECEPTACLE ASSEMBLY, WITH GUIDES MULTI-BEAM XLE
0 PLC ±.01		PRODUCT SPEC 108-1973	SIZE CAGE CODE DRAWING NO. RESTRICTED TO
1 PLC ±.01		APPLICATION SPEC	A100779C=6450850
2 PLC ±.005		114-13038	SCALE 4:1 SHEET 3 OF 8 REV F
3 PLC ±.0020		WEIGHT	
4 PLC ±.0020		CUSTOMER DRAWING	
ANGLES ±.2°			
FINISH			

LOC	DIST	REV	DATE	BY	APPD
ES	00				

REVISIONS			
REV	DATE	BY	APPD
-	-	-	-
SEE SHEET 1			

PART NUMBER	ROWS	POWER				SIGNAL			POWER			
		P8	P7	P6	P5	3	2	1	P4	P3	P2	P1
I-6450850-3	D					E	E	E				
	C					E	E	E				
	B	VM	VM	VM	VM	E	E	E	VM	VM	VM	VM
	A	HD				E	E	E				HD

4P + 12S + 4P

PART NUMBER	ROWS	POWER			SIGNAL				POWER	
		P5	P4	P3	4	3	2	1	P2	P1
I-6450850-4	D				E	E	E	E		
	C				E	E	E	E		
	B	VM	VM	VM	E	E	E	E	VM	VM
	A	HD			E	E	E	E		HD

2HDP + 16S + 3HDP

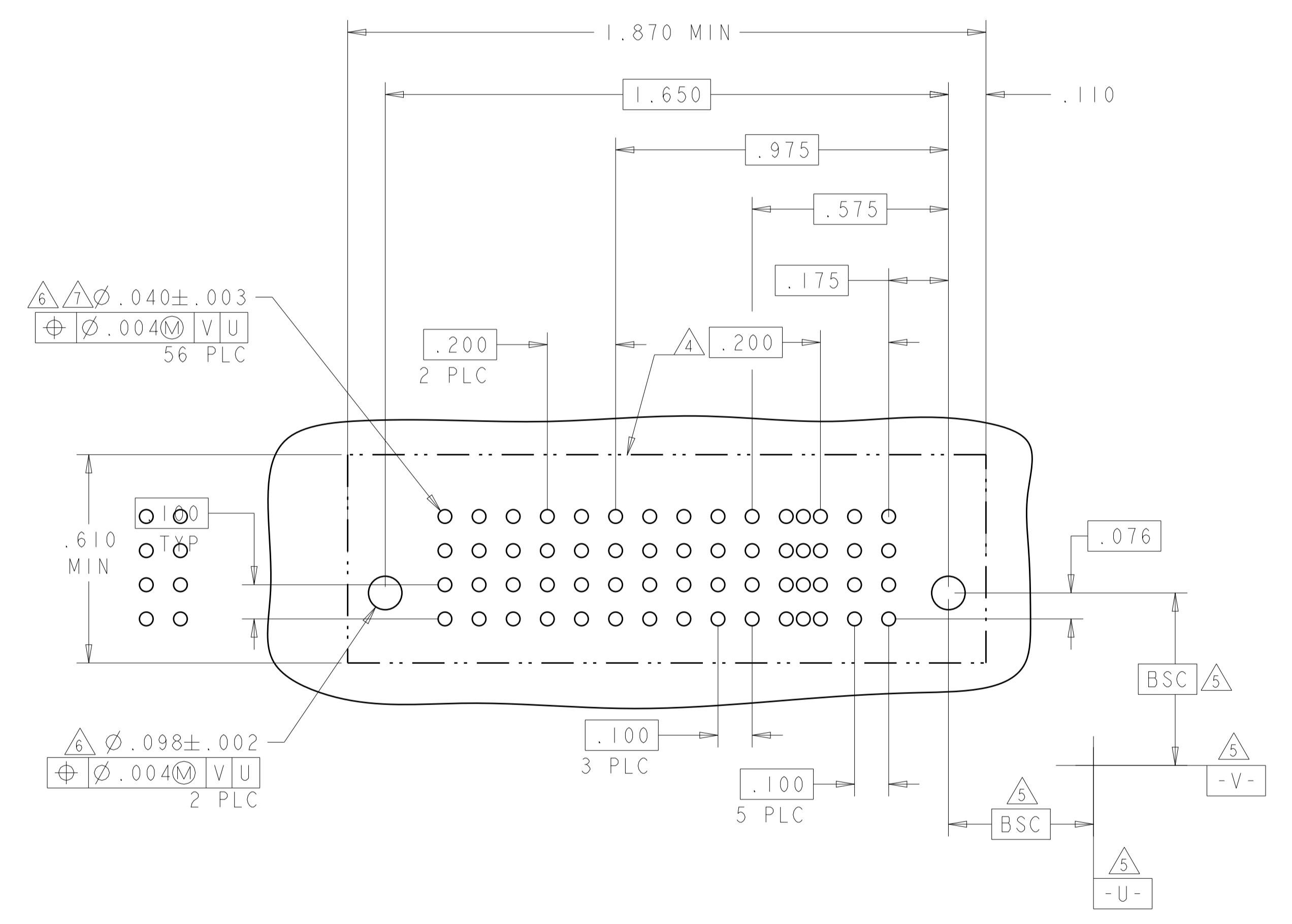
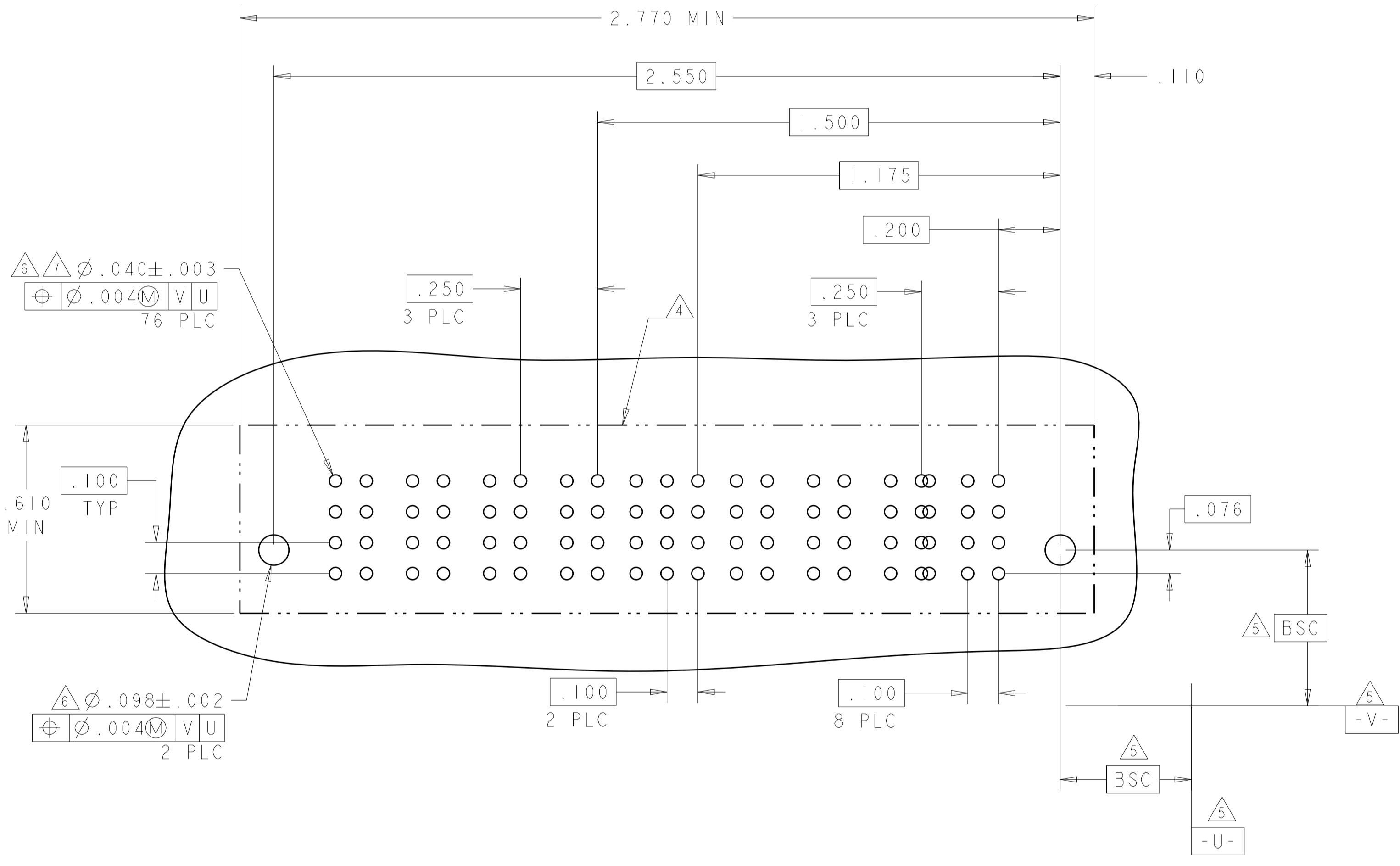

THIS DRAWING IS A CONTROLLED DOCUMENT.		OWN: S. ZHAO 20SEP2007	TE Connectivity
DIMENSIONS: INCHES		CHK: S. ZHAO 20SEP2007	
TOLERANCES UNLESS OTHERWISE SPECIFIED:		APVD: S. YAO	NAME: VERTICAL RECEPTACLE ASSEMBLY, WITH GUIDES MULTI-BEAM XLE
0 PLC	±	PRODUCT SPEC	SIZE: CAGE CODE DRAWING NO
1 PLC	±.01	APPLICATION SPEC	RESTRICTED TO
2 PLC	±.05	114-13038	A100779
3 PLC	±.0020	WEIGHT	C=6450850
4 PLC	±.0020	CUSTOMER DRAWING	SCALE: 4:1 SHEET 4 OF 8 REV F
ANGLES	±.0020		
FINISH			

LOC	DIST	REV	DATE	BY	APPD
ES	00				
REVISIONS			DESCRIPTION	DATE	BY
			SEE SHEET 1		

PART NUMBER	ROWS	POWER				SIGNAL				POWER			
		P8	P7	P6	P5	P4	4	3	2	1	P3	P2	P1
1-6450850-6	D						E	E	E	E			
	C	VA	VM	VM	VM	VA	E	E	E	E	VM	VM	VA
	B						E	E	E	E			
	A	HD					E	E	E	E			HD

3ACP + 16S + 5P

PART NUMBER	ROWS	POWER		SIGNAL		POWER	
		P2	2	1	P1		
1-6450850-7	D						
	C	VM	E	E	VM		
	B		E	E			
	A	HD		E	E	HD	

IP + 8S + IP

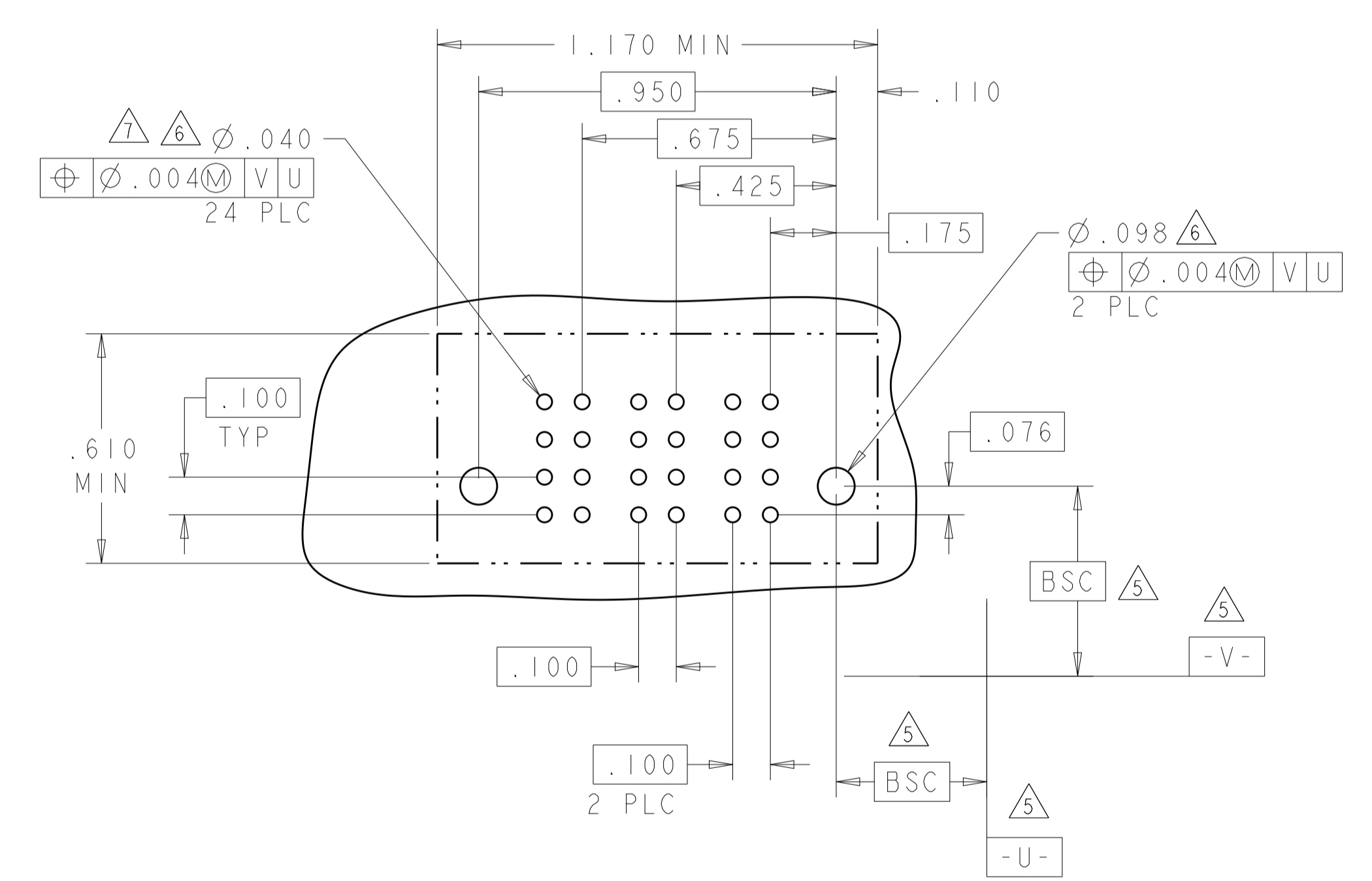
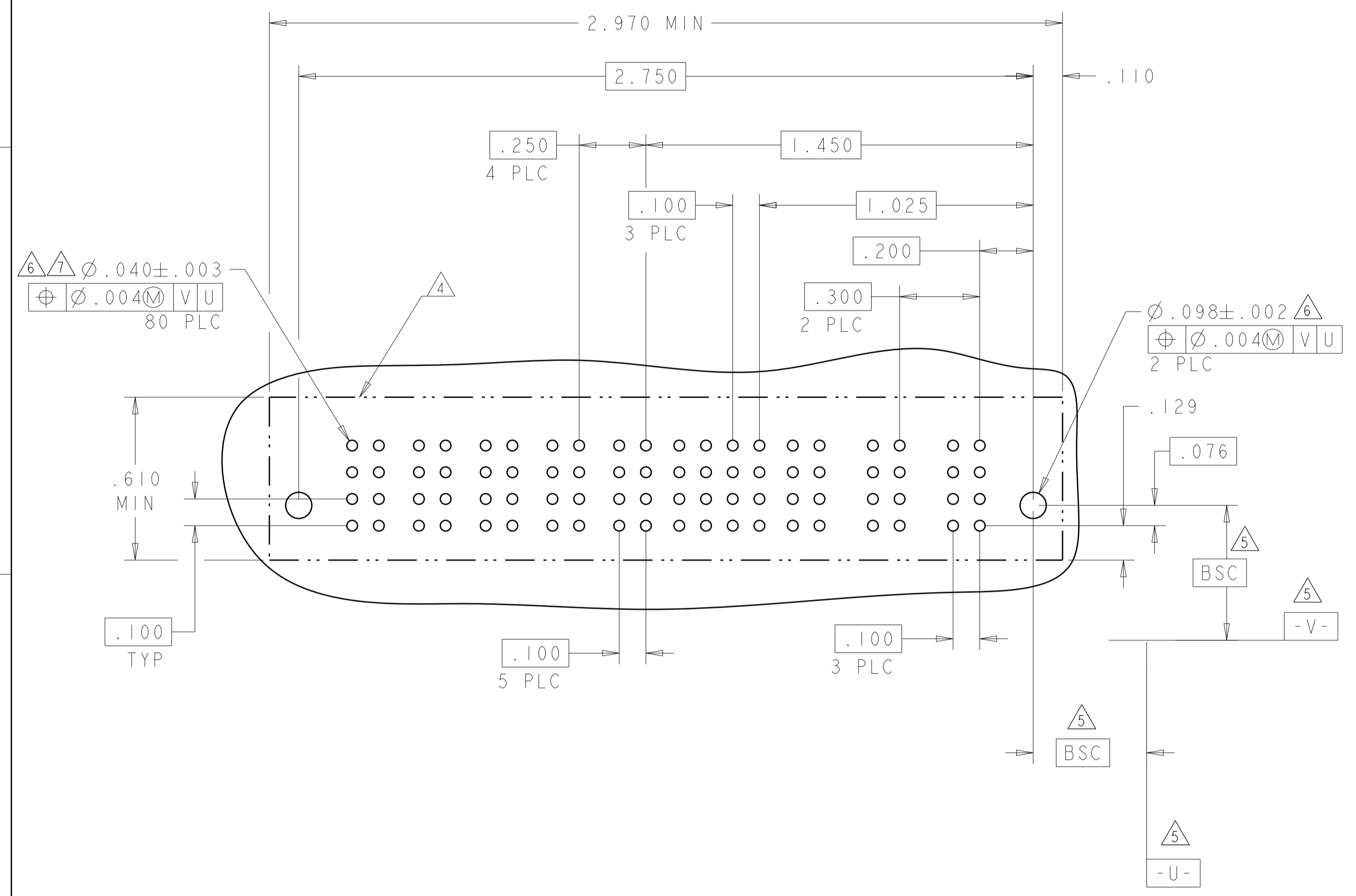

THIS DRAWING IS A CONTROLLED DOCUMENT.		DWN: S. ZHAO 20SEP2007 CHK: S. ZHAO 20SEP2007 APVD: S. YAO	TE Connectivity
DIMENSIONS: INCHES	TOLERANCES UNLESS OTHERWISE SPECIFIED: 0 PLC ±. 1 PLC ±.01 2 PLC ±.01 3 PLC ±.005 4 PLC ±.0020 ANGLES ±.7°	NAME: VERTICAL RECEPTACLE ASSEMBLY, WITH GUIDES MULTI-BEAM XLE PRODUCT SPEC: 108-1973 APPLICATION SPEC: 114-13038 WEIGHT: - CUSTOMER DRAWING	

LOC		DIST		REVISIONS			
ES	00	P	LTN	DESCRIPTION	DATE	DMN	APVD
				SEE SHEET 1			

PART NUMBER	ROWS	LOW POWER				SIGNAL			LOW POWER		
		LP7	LP6	LP5	LP4	3	2	1	LP3	LP2	LP1
2-6450850-0	D					E	E	E			
	C					E	E	E			
	B					E	E	E			
	A	LM	LM	LM	LM	E	E	E	LM	LM	LM
		HD									HD
3LP + 12S + 4LP											

PART NUMBER	ROWS	POWER			SIGNAL				POWER		
		P6	P5	P4	4	3	2	1	P3	P2	P1
2-6450850-1	D				E	E	E	E			
	C				E	E	E	E			
	B				E	E	E	E			
	A	VA	VM	VA	E	E	E	E	VM	VM	VA
		HD									HD
3ACP + 16S + 3P											

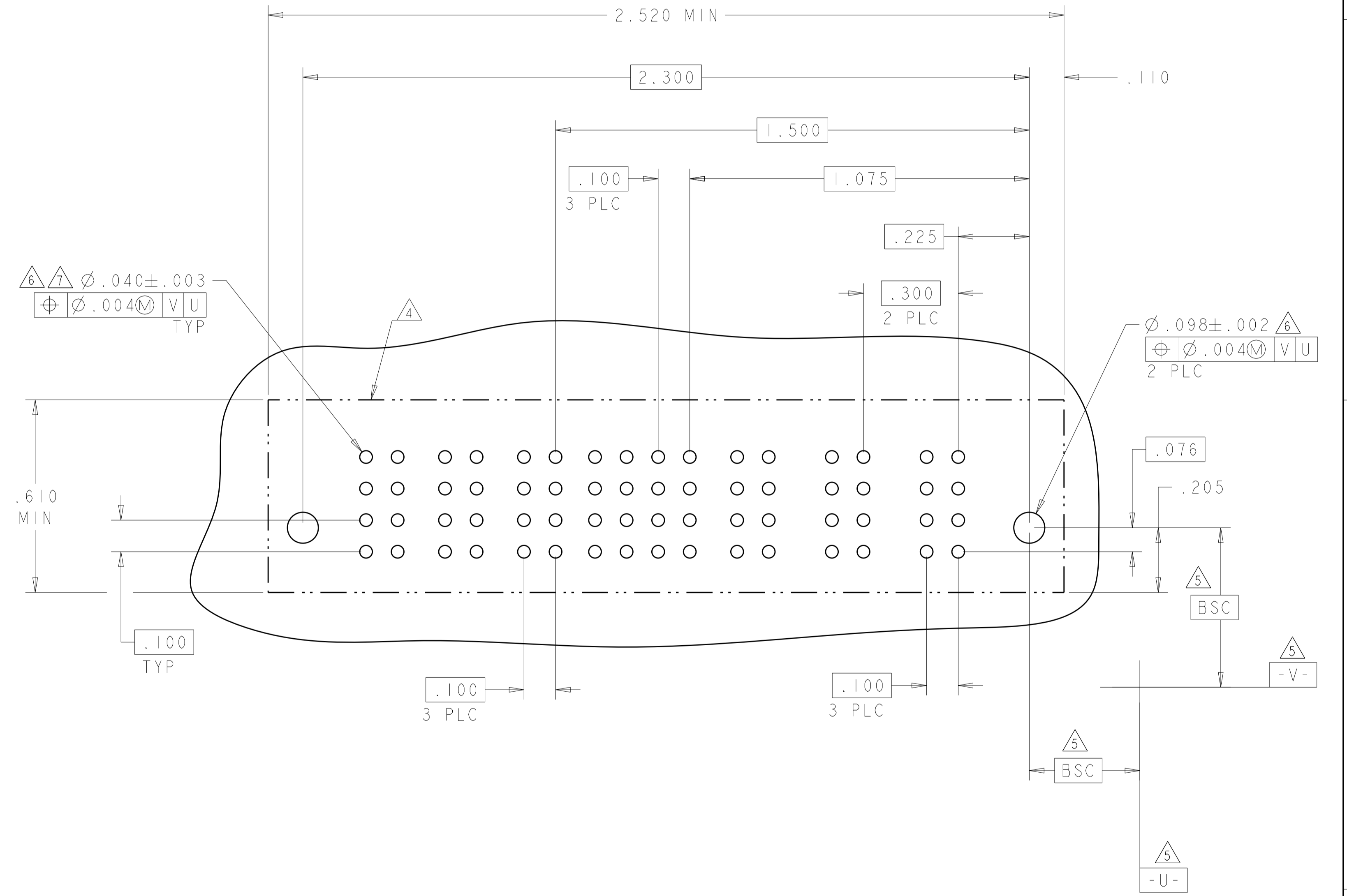
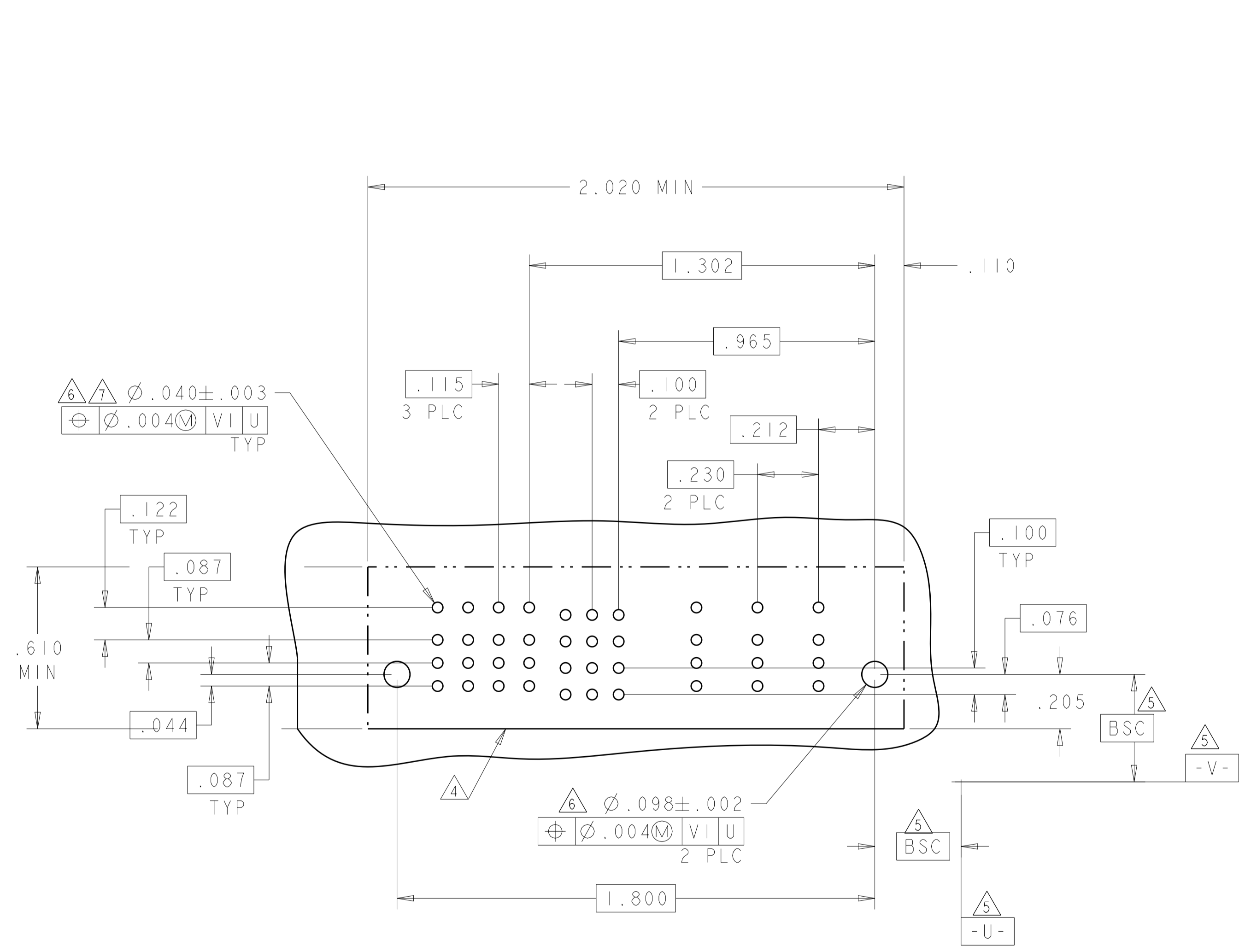

THIS DRAWING IS A CONTROLLED DOCUMENT.		DMN S. ZHAO 20SEP2007	TE Connectivity
DIMENSIONS: INCHES		CHK S. ZHAO 20SEP2007	
TOLERANCES UNLESS OTHERWISE SPECIFIED:		APVD S. YAO	NAME
0 PLC ±		PRODUCT SPEC	VERTICAL RECEPTACLE ASSEMBLY, WITH GUIDES
1 PLC ±.01		APPLICATION SPEC	MULTI-BEAM XLE
2 PLC ±.05		WEIGHT	SIZE CAGE CODE DRAWING NO
3 PLC ±.0020		FINISH	RESTRICTED TO
4 PLC ±.0020			A100779C=6450850
ANGLES ±.7°			SCALE 4:1 SHEET 7 OF 8 REV F
MATERIAL		CUSTOMER DRAWING	

