

LOC		DIST		REVISIONS			
				REV	DATE	BY	APPV
		A		RELEASED DRAWING	22DEC2015	TZ	SZ
		A1		ECR-16-017528	20DEC2016	TZ	SZ
		A2		ECR-17-003044	08MAR2017	TZ	SZ

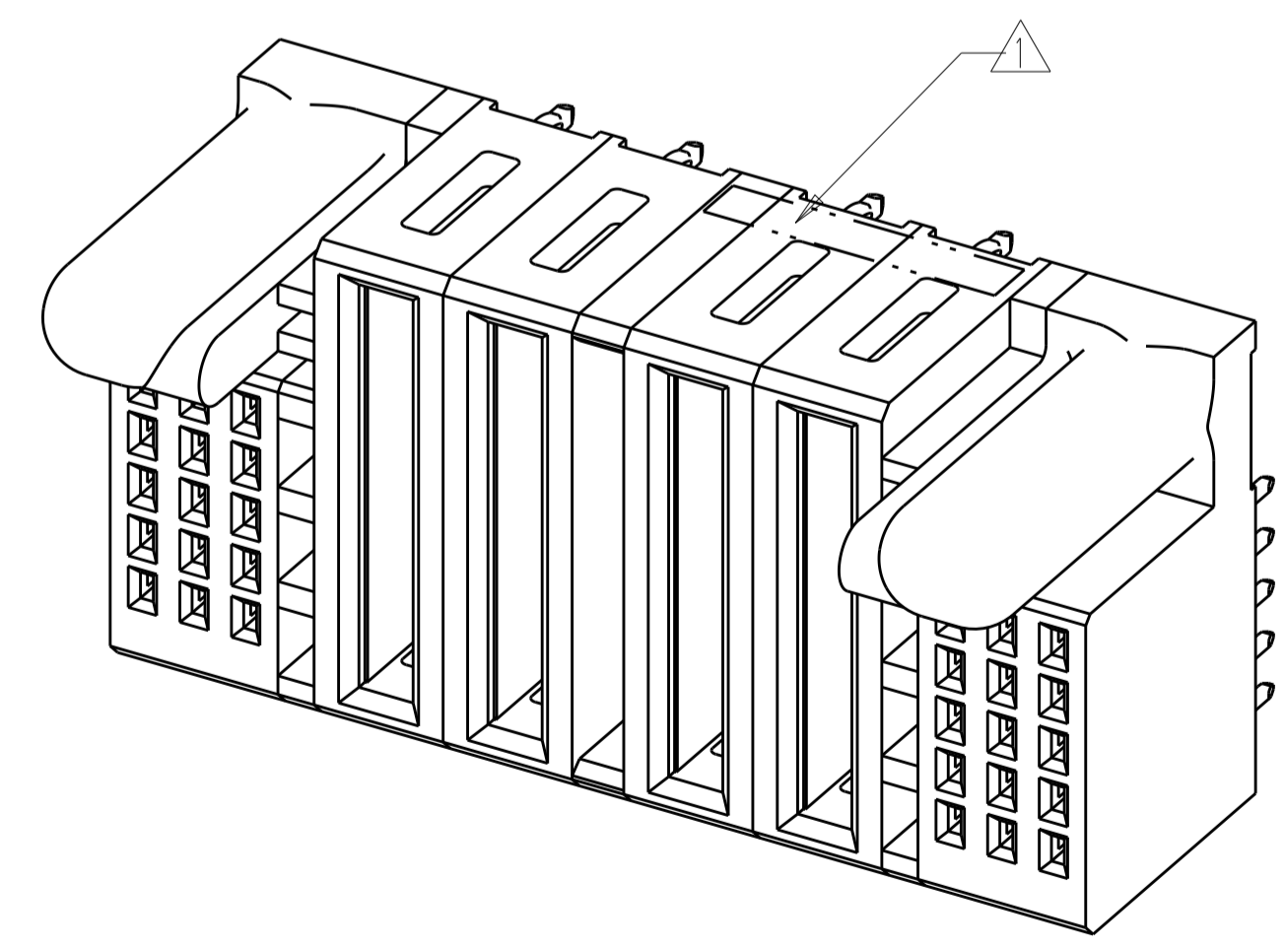
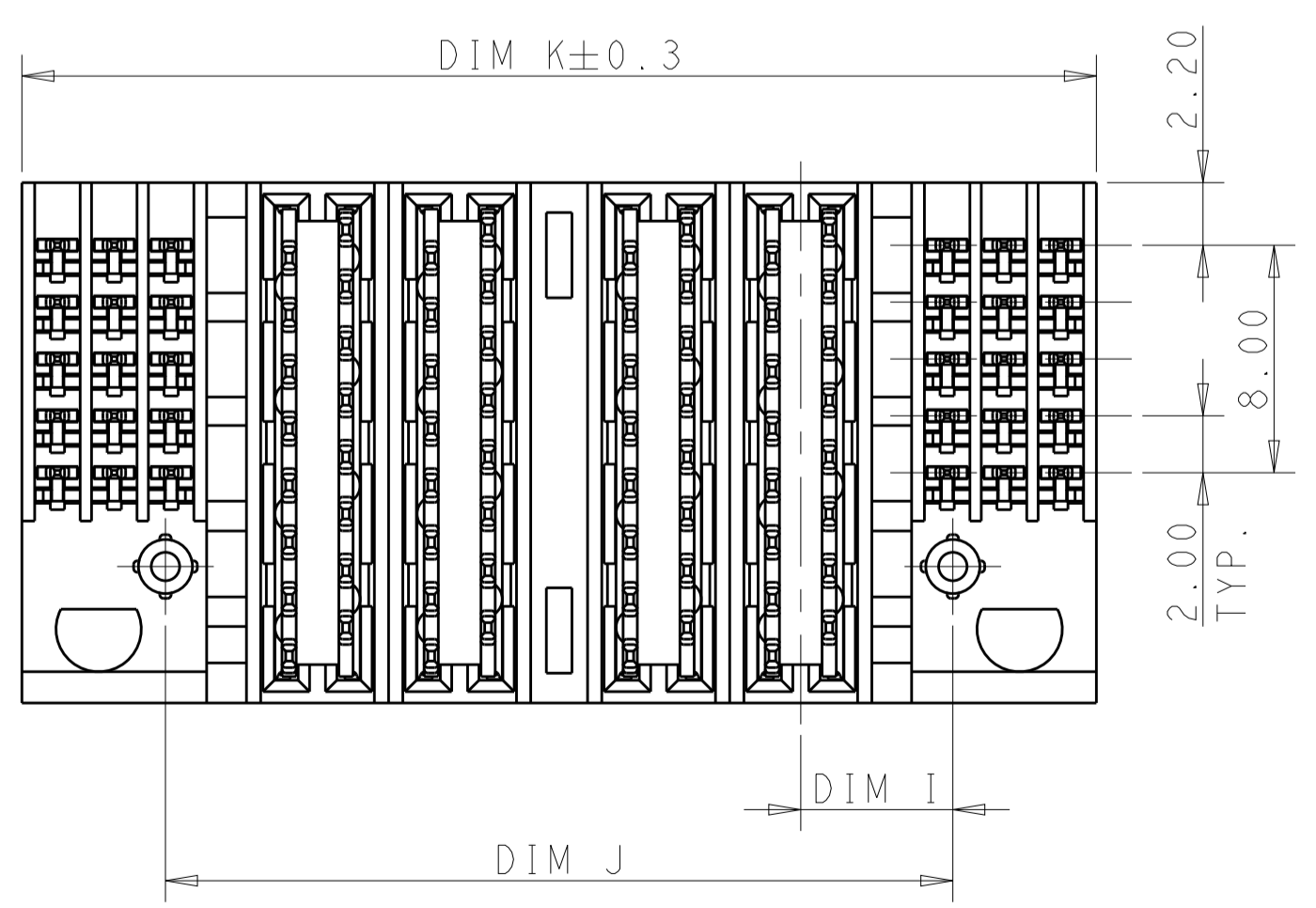
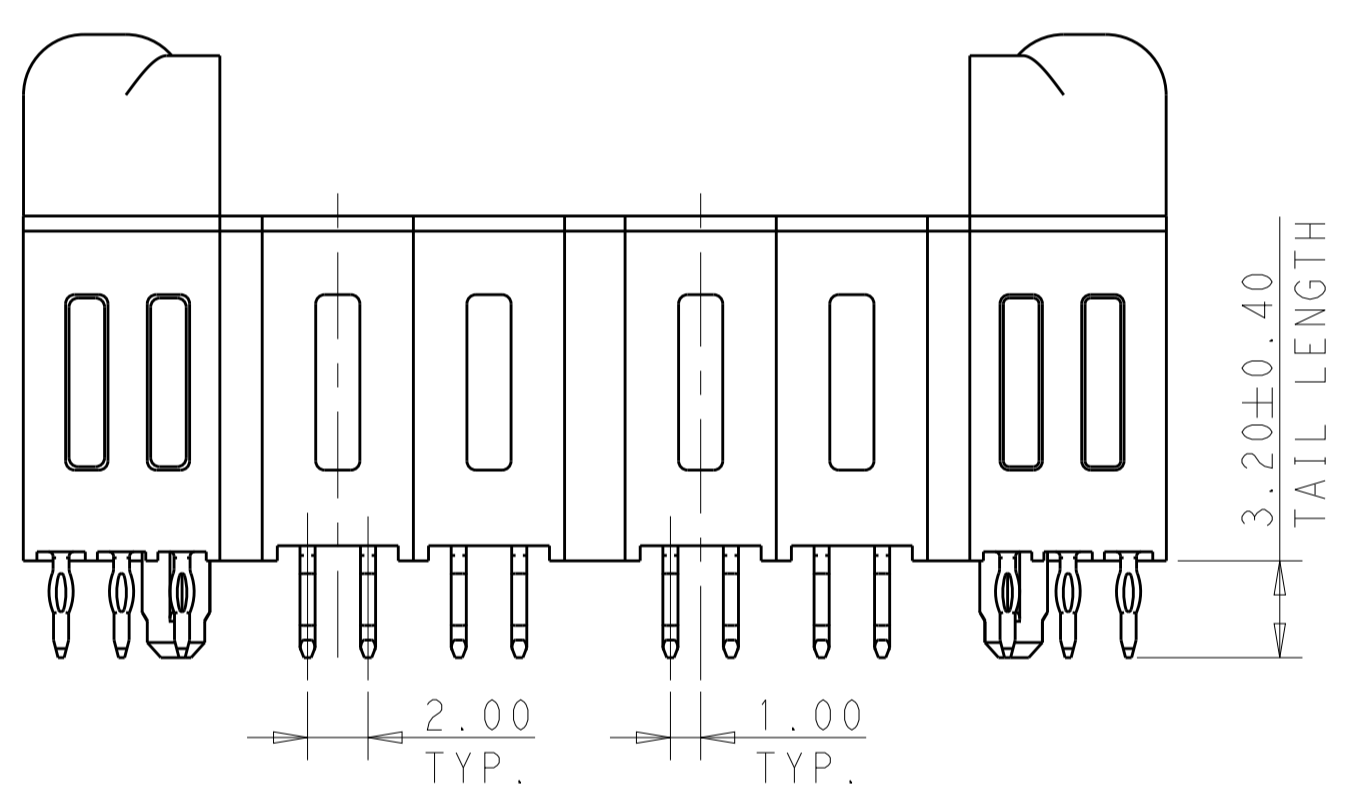
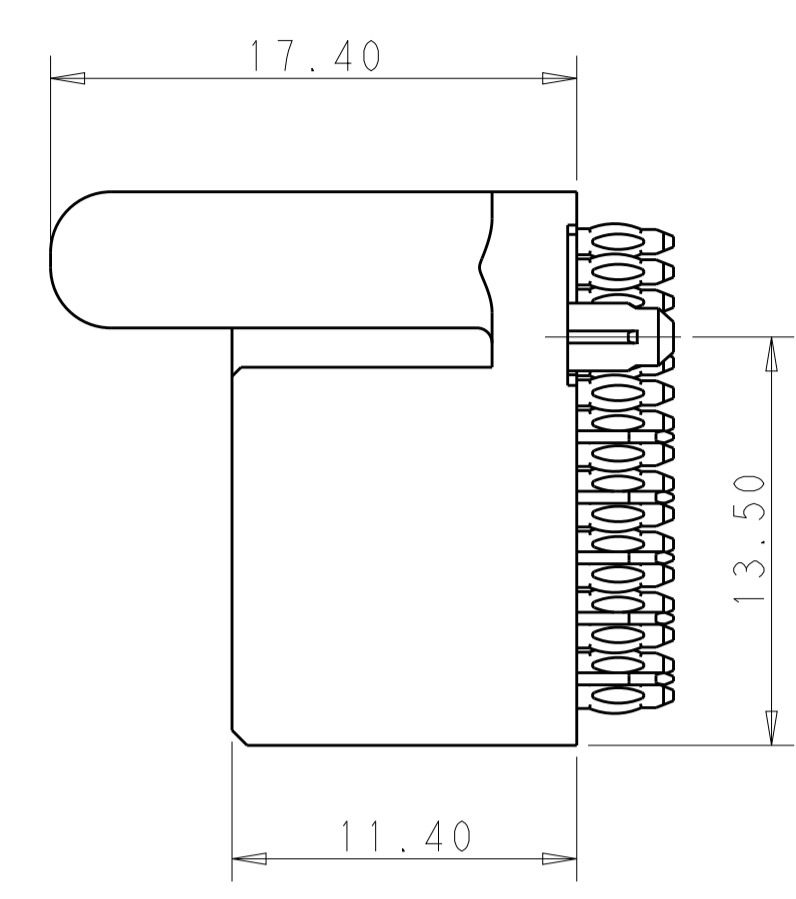
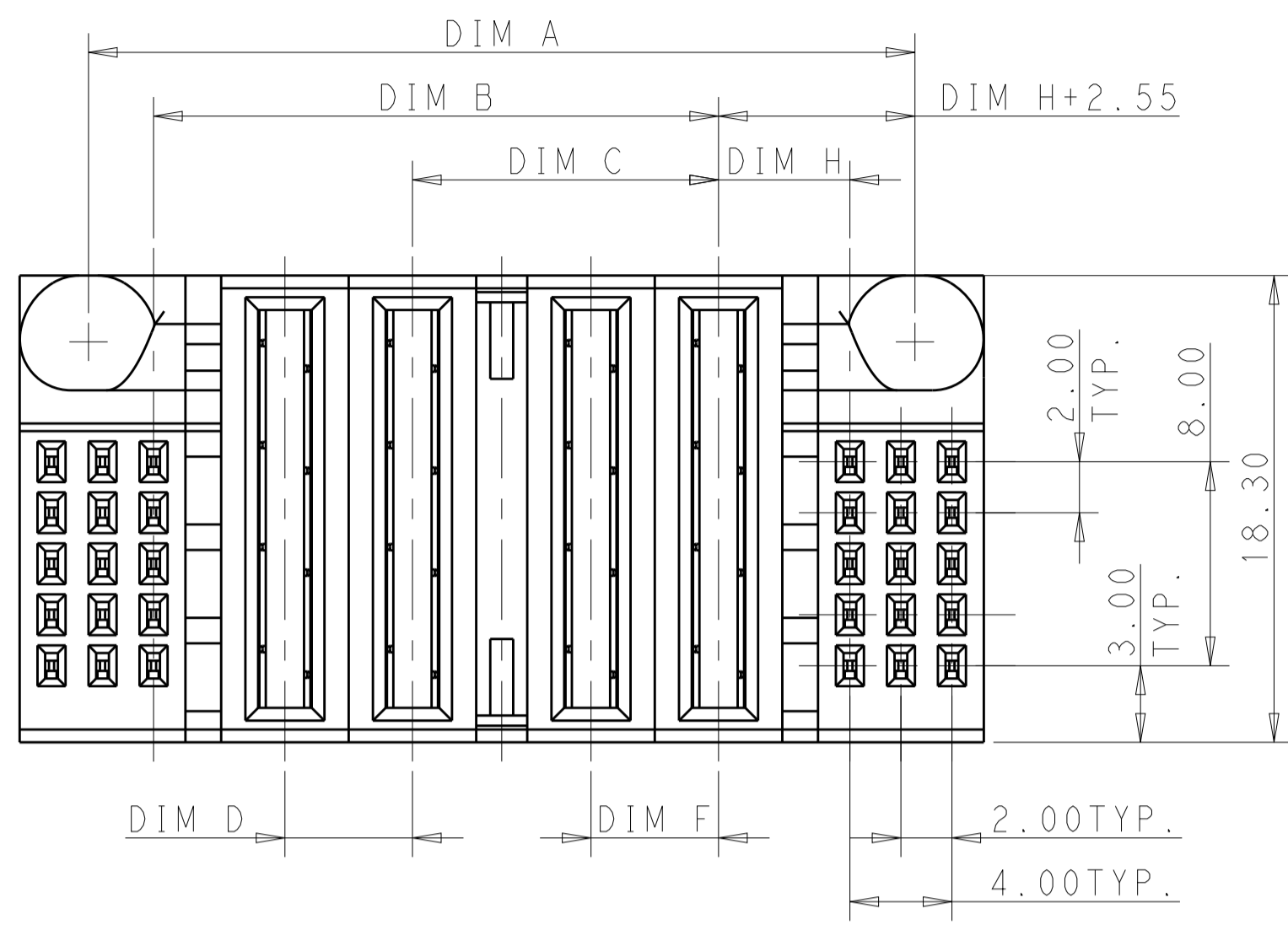

NOTES, UNLESS OTHERWISE SPECIFIED:

① "TE", PART NUMBER AND DATE CODE TO BE MARKED IN AREA SHOWN.

② MATERIAL:  
 HOUSING - GLASS FILLED HIGH TEMP THERMO PLASTIC,  
 COLOR: BLACK, UL94 V- 0.  
 SIGNAL CONTACT - HIGH CONDUCTIVITY COPPER ALLOY.  
 POWER CONTACT - HIGH CONDUCTIVITY COPPER ALLOY.

③ CONTACT PLATING:  
 MATING AREA - NOBLE METAL OVERALL NICKEL  
 TAIL SIDE AREA - MATTE TIN OVERALL NICKEL.

4. MECHANICAL CONNECTOR KEEP OUT ZONE.

⑤ DATUM AND BASIC DIMENSIONS ESTABLISHED BY CUSTOMER.

⑥ PCB - ALL HOLE DIAMETERS ARE FINISHED HOLE SIZES.

⑦ PCB HOLE:  
 POWER -  $1.15 \pm 0.025$  MM DRILLED HOLES SIZE PLATING WITH 0.0076 MM MIN.  
 Sn OVER 0.025-0.076 MM Cu PLATING TO ACHIEVE A 1.02 MM DIA. HOLE.  
 SIGNAL -  $0.835 \pm 0.025$  MM DRILLED HOLES SIZE PLATING WITH 0.0076 MM MIN.  
 Sn OVER 0.025-0.076 MM Cu PLATING TO ACHIEVE A 0.72 MM DIA. HOLE.

THIS DRAWING IS A CONTROLLED DOCUMENT.		OWN THOMAS ZHAO 20DEC2012	TE Connectivity
DIMENSIONS: mm		CHK SUNY ZHAO 20DEC2012	
TOLERANCES UNLESS OTHERWISE SPECIFIED:		APVD SUNY ZHAO 20DEC2012	NAME Customer Drawing
0 PLC ±0.4 1 PLC ±0.4 2 PLC ±0.25 3 PLC ±0.15 4 PLC ±0.15 ANGLES ±°		PRODUCT SPEC	VERTICAL RECEPTACLE
MATERIAL		APPLICATION SPEC	MULTI-BEAM HD S+P+P+S
FINISH		WEIGHT	SIZE A1
① ③		CAGE CODE DRAWING NO. C=2204420	RESTRICTED TO
CUSTOMER DRAWING		SCALE 4:1	SHEET 1 OF 7 REV A2

LOC		DIST		REVISIONS			
P	LTN	DESCRIPTION	DATE	DMN	APVD		
-	-	SEE SHEET 1	-	-	-		

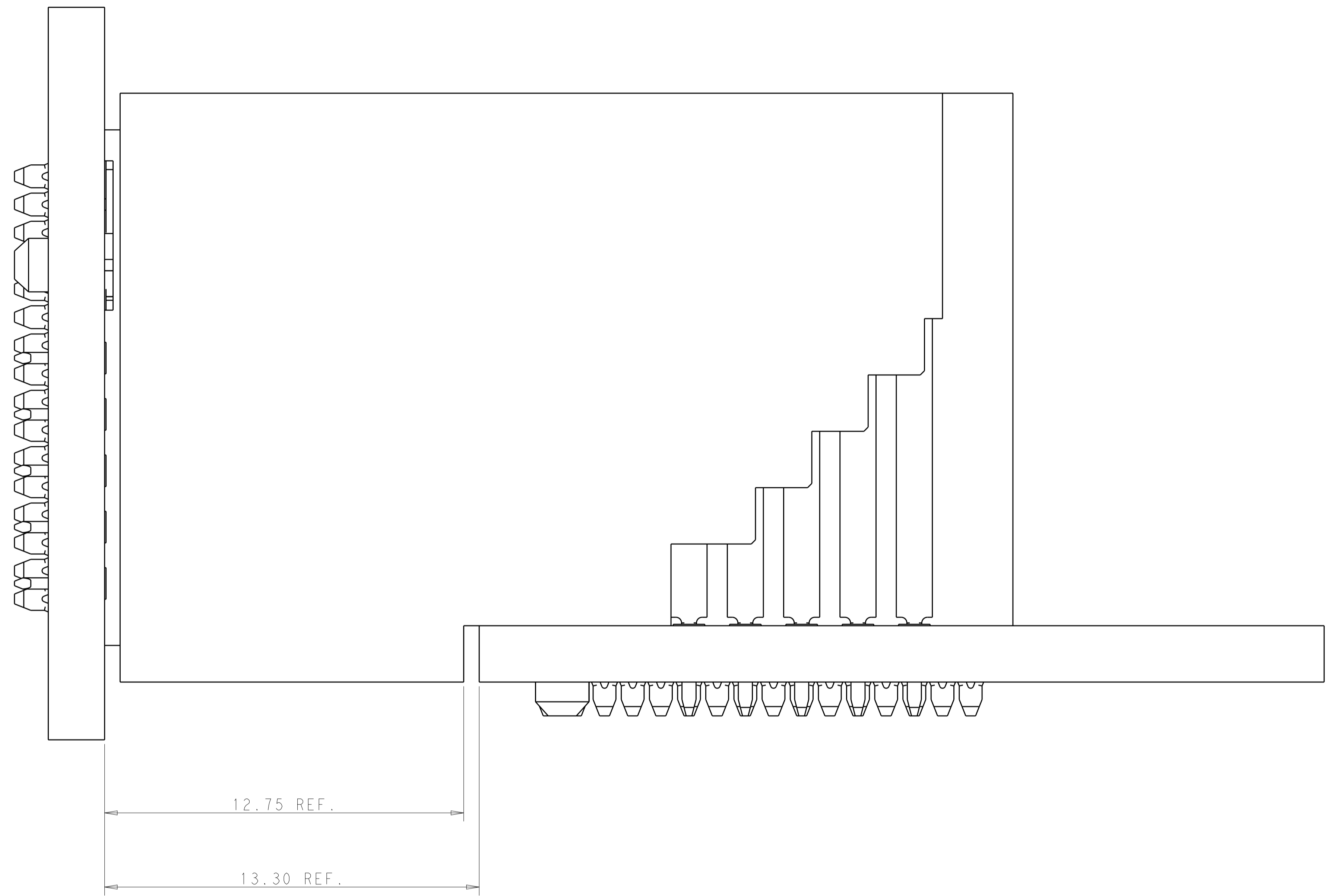

THE DISTANCE IS 0.05 MM MATING FACE FROM R/A HEADER TO VERTICAL RECEPTACLE.

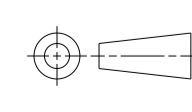
THIS DRAWING IS A CONTROLLED DOCUMENT.		DMN THOMAS_ZHAO Z0DEC2012	 TE Connectivity
DIMENSIONS: mm		CHK SUNY_ZHAO Z0DEC2012	
TOLERANCES UNLESS OTHERWISE SPECIFIED: 0 PLC ±.4 1 PLC ±0.4 2 PLC ±0.75 3 PLC ±1.5 4 PLC ±.4 ANGLES ±.1		APVD SUNY_ZHAO Z0DEC2012	NAME Customer Drawing
		PRODUCT SPEC	VERTICAL RECEPTACLE
MATERIAL		APPLICATION SPEC	MULTI-BEAM HD S+P+S
FINISH		WEIGHT	SIZE CAGE CODE DRAWING NO RESTRICTED TO
CUSTOMER DRAWING		SCALE 4:1	A100779C=2204420
		SHEET 2 OF 7	REV A2

LOC	DIST	REV	DATE	BY	APPD
		1			

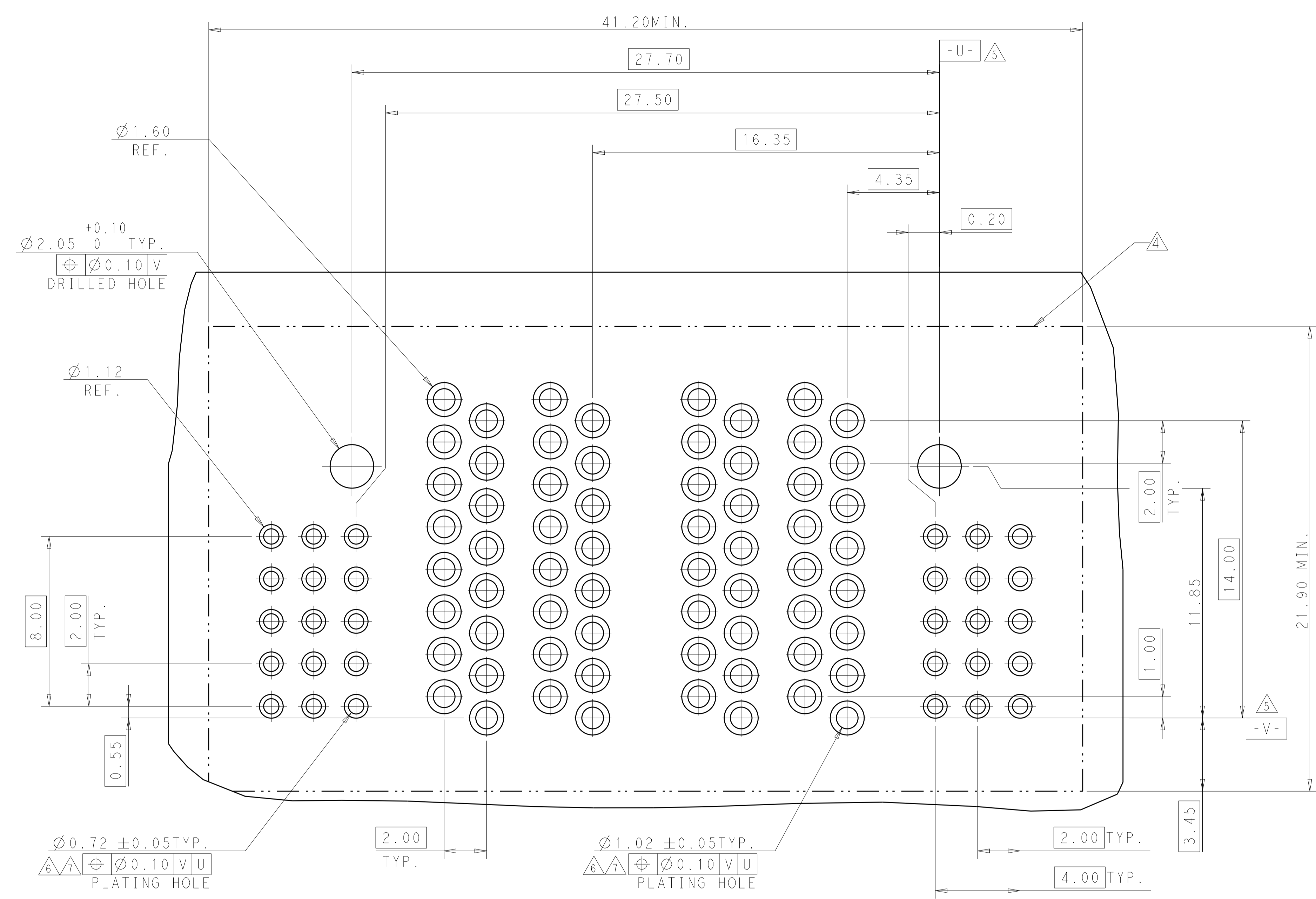

PART NUMBER	ROWS	SIGNAL			POWER				SIGNAL		
		6	5	4	P4	P3	P2	P1	3	2	1
2204420-1	E	SM	SM	SM	PM	PM	PM	PM	SM	SM	SM
	D	SM	SM	SM					SM	SM	SM
	C	SM	SM	SM					SM	SM	SM
	B	SM	SM	SM					SM	SM	SM
	A	SM	SM	SM					SM	SM	SM

15S+2P+2P+15S

DIM A	DIM B	DIM C	DIM D	DIM E	DIM F	DIM H	DIM I	DIM J	DIM K	DESCRIPTION	PART NUMBER
42.40	32.15	17.00	5.00	5.00	5.15	5.35	37.70	47.80	15S+3P+3P+15S	1-2204420-1	
50.40	40.15	21.00	7.00	7.00	5.15	5.35	45.70	55.80	15S+3HVP+3HVP+15S	1-2204420-0	
42.40	32.15	17.00	5.00	5.00	5.15	5.35	37.70	47.80	15S+3P+3P+15S	2204420-9	
19.40	15.15	-	-	5.00	5.15	5.35	20.70	30.80	15S+3P+12S	2204420-8	
22.40	12.15	7.00	-	-	5.15	5.35	17.70	27.80	15S+1P+1P+15S	2204420-6/7	
62.40	52.15	27.00	5.00	5.00	5.15	5.35	57.70	67.80	10S+5P+5P+10S	2204420-5	
92.40	82.15	42.00	5.00	5.00	5.15	5.35	87.70	97.80	15S+8P+8P+15S	2204420-3	
78.40	68.15	42.00	7.00	5.00	5.15	5.35	73.70	83.80	15S+8P+4P+15S	2204420-2	
32.40	22.15	12.00	5.00	5.00	5.15	5.35	27.70	37.80	15S+2P+2P+15S	2204420-1	

THIS DRAWING IS A CONTROLLED DOCUMENT.

DWG: THOMAS\_ZHAO\_Z0DEC2012  
 CHK: SUNY\_ZHAO\_Z0DEC2012  
 APVD: SUNY\_ZHAO\_Z0DEC2012

DIMENSIONS: mm  
 TOLERANCES UNLESS OTHERWISE SPECIFIED:  
 0 PLC ±0.4  
 1 PLC ±0.4  
 2 PLC ±0.25  
 3 PLC ±0.15  
 4 PLC ±0.15  
 ANGLES ±°

MATERIAL: -  
 FINISH: -

WEIGHT: -  
 CUSTOMER DRAWING

**STE** TE Connectivity  
 NAME: Customer Drawing  
 VERTICAL RECEPTACLE  
 MULTI-BEAM HD S+P+P+S  
 SIZE: A1  
 CAGE CODE: 00779  
 DRAWING NO: 2204420  
 SCALE: 4:1  
 SHEET: 3 OF 7  
 REV: A2

LOC		DIST		REVISIONS			
P	LTN	DESCRIPTION	DATE	DMN	APVD		
-	-	SEE SHEET 1	-	-	-	-	-

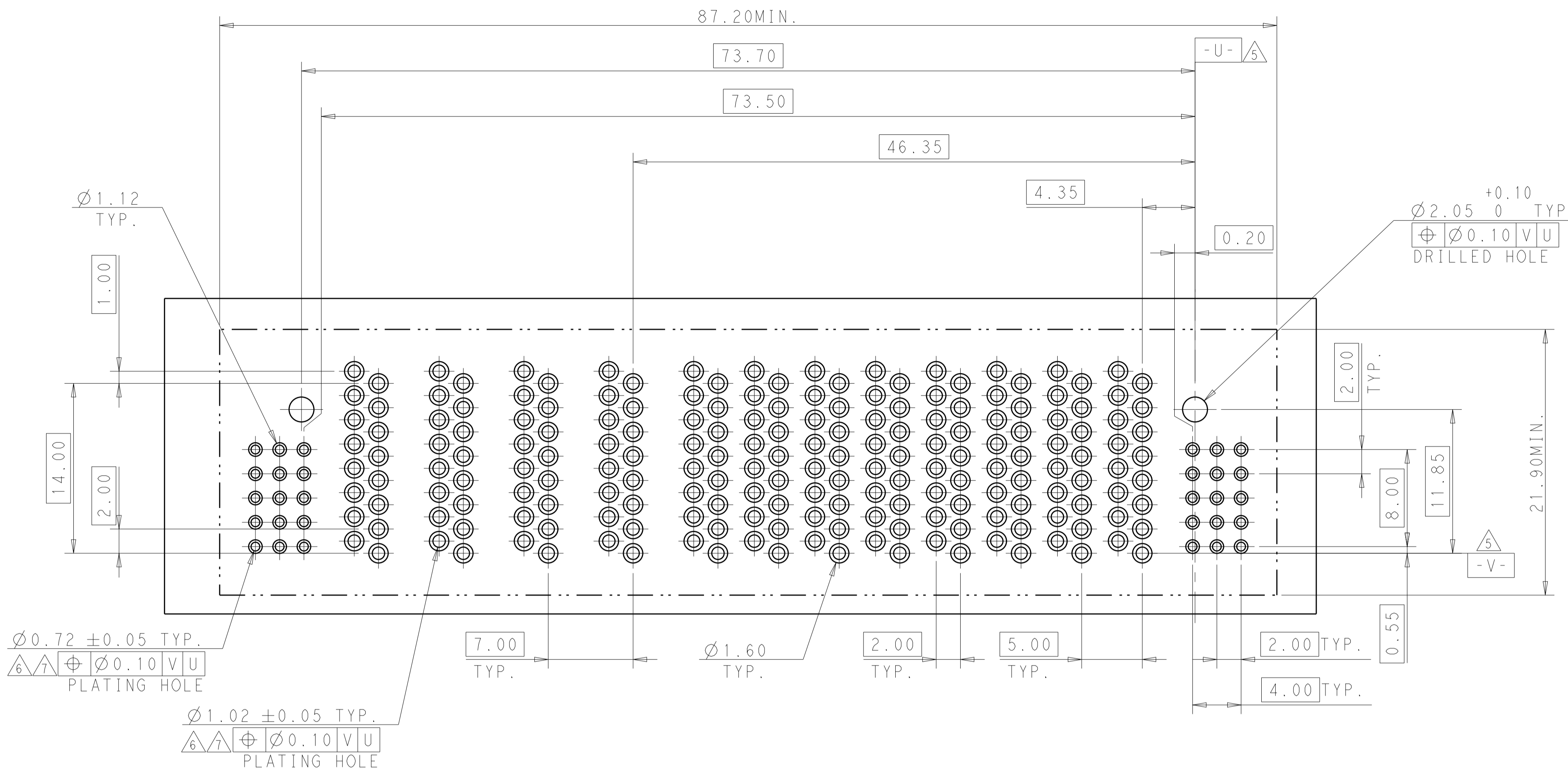

PART NUMBER	ROWS	SIGNAL			POWER											SIGNAL						
		6	5	4	PI2	PI1	PI0	P9	P8	P7	P6	P5	P4	P3	P2	PI	3	2	1			
2204420-2	E	SMI	SMI	SMI	PM	PM	PM	PM	PM	PM	PM	PM	PM	PM	PM	PM	SMI	SMI	SMI			
	D	SMI	SMI	SMI																SMI	SMI	SMI
	C	SMI	SMI	SMI																SMI	SMI	SMI
	B	SMI	SMI	SMI																SMI	SMI	SMI
	A	SMI	SMI	SMI																SMI	SMI	SMI
15S+8HP+4HP+15S																						

SIGNAL CONTACT	SMI
POWER CONTACT STANDARD	PN
POWER CONTACT MFBL	PM
DESCRIPTION	IDENTIFIER

THIS DRAWING IS A CONTROLLED DOCUMENT. DWN THOMAS ZHAO Z0DEC2012  
 CHK SUNY ZHAO Z0DEC2012  
 APVD SUNY ZHAO Z0DEC2012

**STE** TE Connectivity

NAME Customer Drawing  
 PRODUCT SPEC VERTICAL RECEPTACLE  
 APPLICATION SPEC MULTI-BEAM HD S+P+P+S

DIMENSIONS: mm  
 TOLERANCES UNLESS OTHERWISE SPECIFIED:  
 0 PLC ±0.4  
 1 PLC ±0.4  
 2 PLC ±0.25  
 3 PLC ±0.15  
 4 PLC ±0.15  
 ANGLES ±°

MATERIAL: - FINISH: - WEIGHT: -

SIZE: A1 CAGE CODE: 2204420 DRAWING NO: 100779  
 RESTRICTED TO: -

CUSTOMER DRAWING SCALE: 4:1 SHEET: 4 OF 7 REV: A2

LOC	DIST	REVISIONS			
P	LTM	DESCRIPTION	DATE	DWN	APVD
-	-	SEE SHEET 1	-	-	-

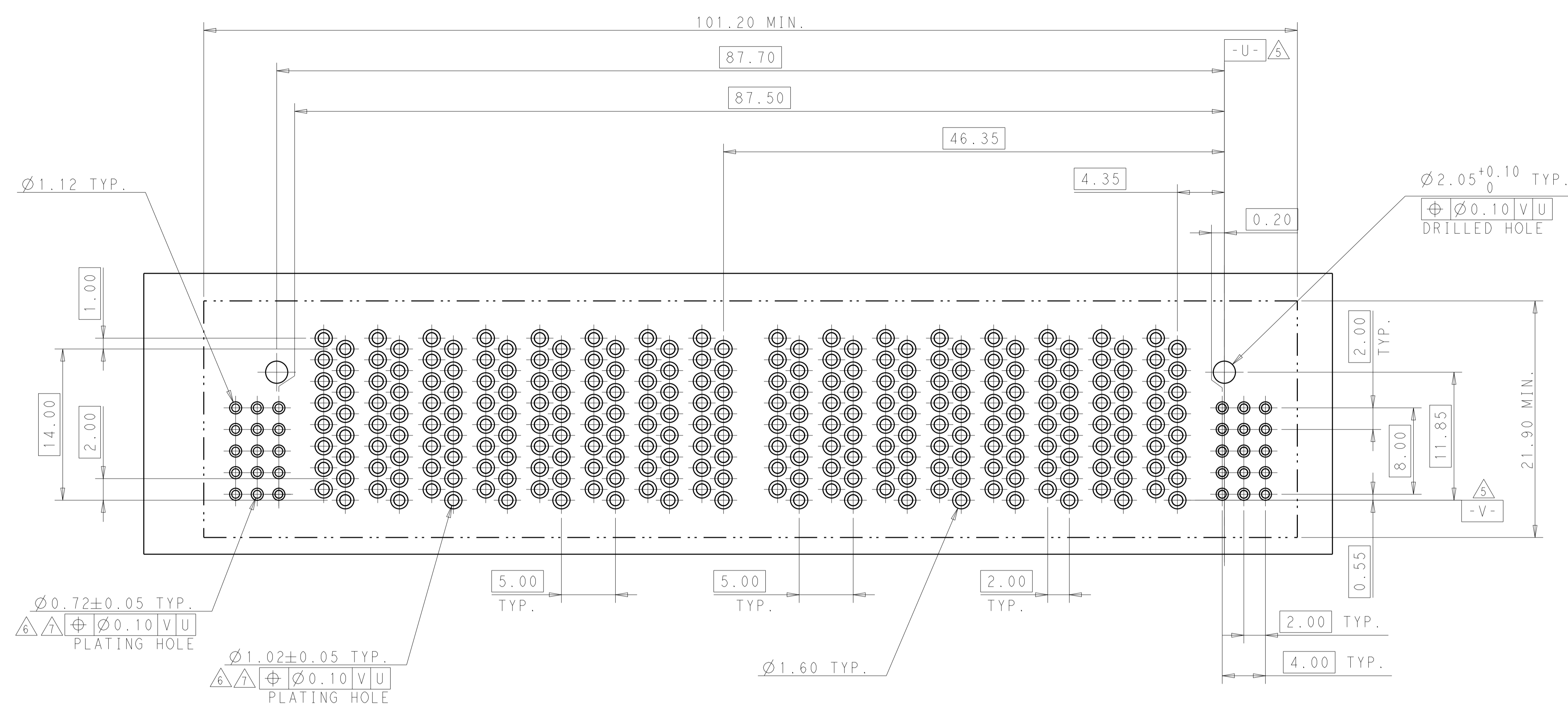

PART NUMBER	ROWS	SIGNAL			POWER																SIGNAL																					
		6	5	4	PI6	PI5	PI4	PI3	PI2	PI1	PI0	P9	P8	P7	P6	P5	P4	P3	P2	PI	3	2	1																			
2204420-3	E D C B A				PM	PM	PM	PM	PM	PM	PM	PM	PM	PM	PM	PM	PM	PM	PM	PM	PM																					
																									SMI	SMI	SMI	SMI	SMI	SMI	SMI	SMI	SMI	SMI	SMI	SMI	SMI	SMI	SMI	SMI	SMI	SMI
		SMI	SMI	SMI																		SMI	SMI	SMI	SMI	SMI	SMI	SMI	SMI	SMI	SMI	SMI	SMI	SMI	SMI	SMI	SMI	SMI	SMI	SMI	SMI	SMI
		SMI	SMI	SMI																		SMI	SMI	SMI	SMI	SMI	SMI	SMI	SMI	SMI	SMI	SMI	SMI	SMI	SMI	SMI	SMI	SMI	SMI	SMI	SMI	SMI
		SMI	SMI	SMI																		SMI	SMI	SMI	SMI	SMI	SMI	SMI	SMI	SMI	SMI	SMI	SMI	SMI	SMI	SMI	SMI	SMI	SMI	SMI	SMI	SMI
		SMI	SMI	SMI																		SMI	SMI	SMI	SMI	SMI	SMI	SMI	SMI	SMI	SMI	SMI	SMI	SMI	SMI	SMI	SMI	SMI	SMI	SMI	SMI	SMI

15S+8HP+8HP+15S

THIS DRAWING IS A CONTROLLED DOCUMENT.

DIMENSIONS:	TOLERANCES UNLESS OTHERWISE SPECIFIED:	DWN THOMAS_ZHAO Z0DEC2012	
mm	0 PLC ±0.4 1 PLC ±0.4 2 PLC ±0.75 3 PLC ±1.15 4 PLC ±1.5 ANGLES ±°	CHK SUNY_ZHAO Z0DEC2012	
MATERIAL	FINISH	APVD SUNY_ZHAO Z0DEC2012	NAME Customer Drawing
		PRODUCT SPEC	VERTICAL RECEPTACLE
		APPLICATION SPEC	MULTI-BEAM HD S+P+P+S
		WEIGHT	SIZE CAGE CODE DRAWING NO RESTRICTED TO
		CUSTOMER DRAWING	A100779C=2204420
		SCALE 4:1	SHEET 5 OF 7 REV A2

LOC	DIST	REVISIONS			
P	LTH	DESCRIPTION	DATE	DMN	APVD
-	-	SEE SHEET 1	-	-	-

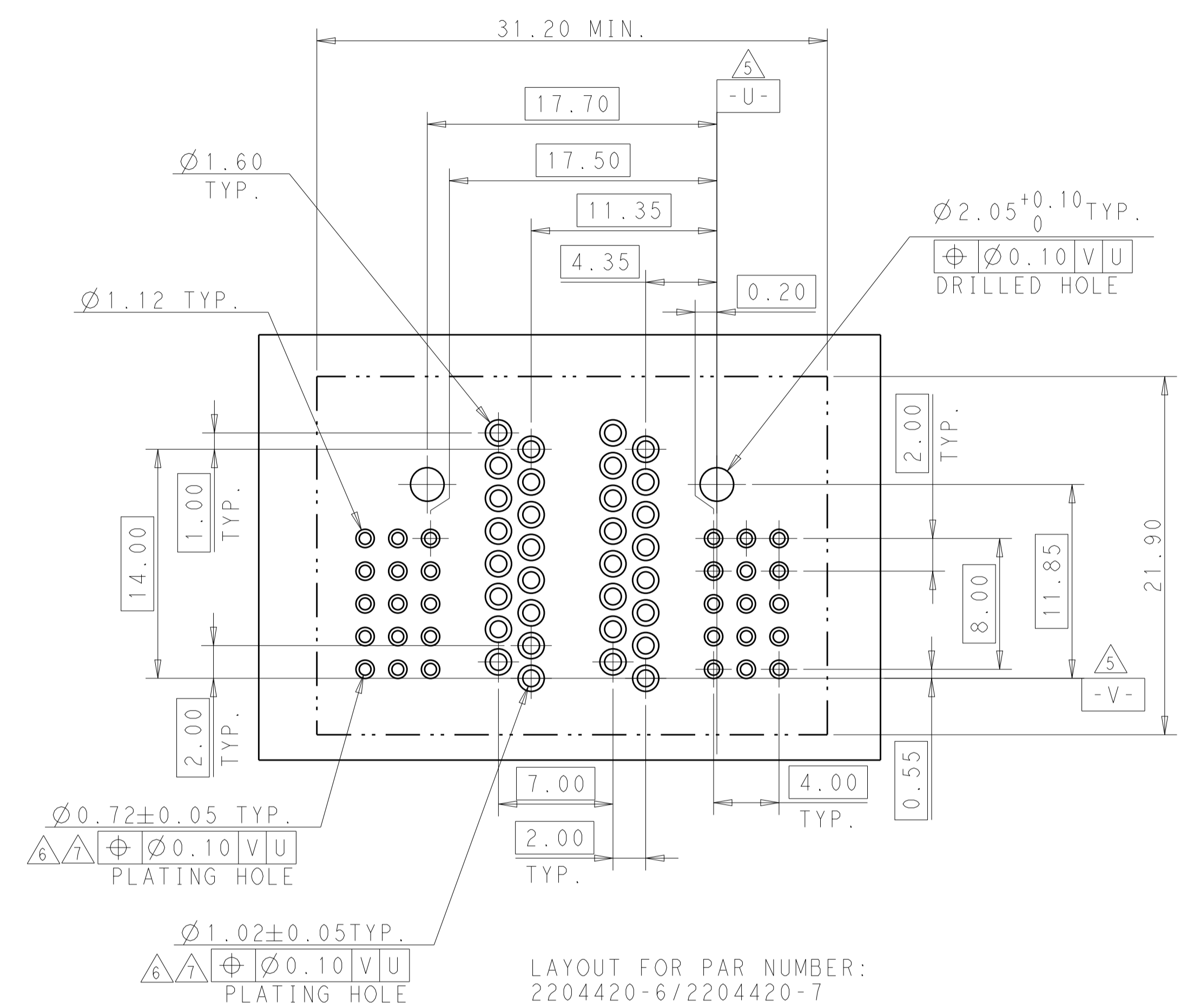
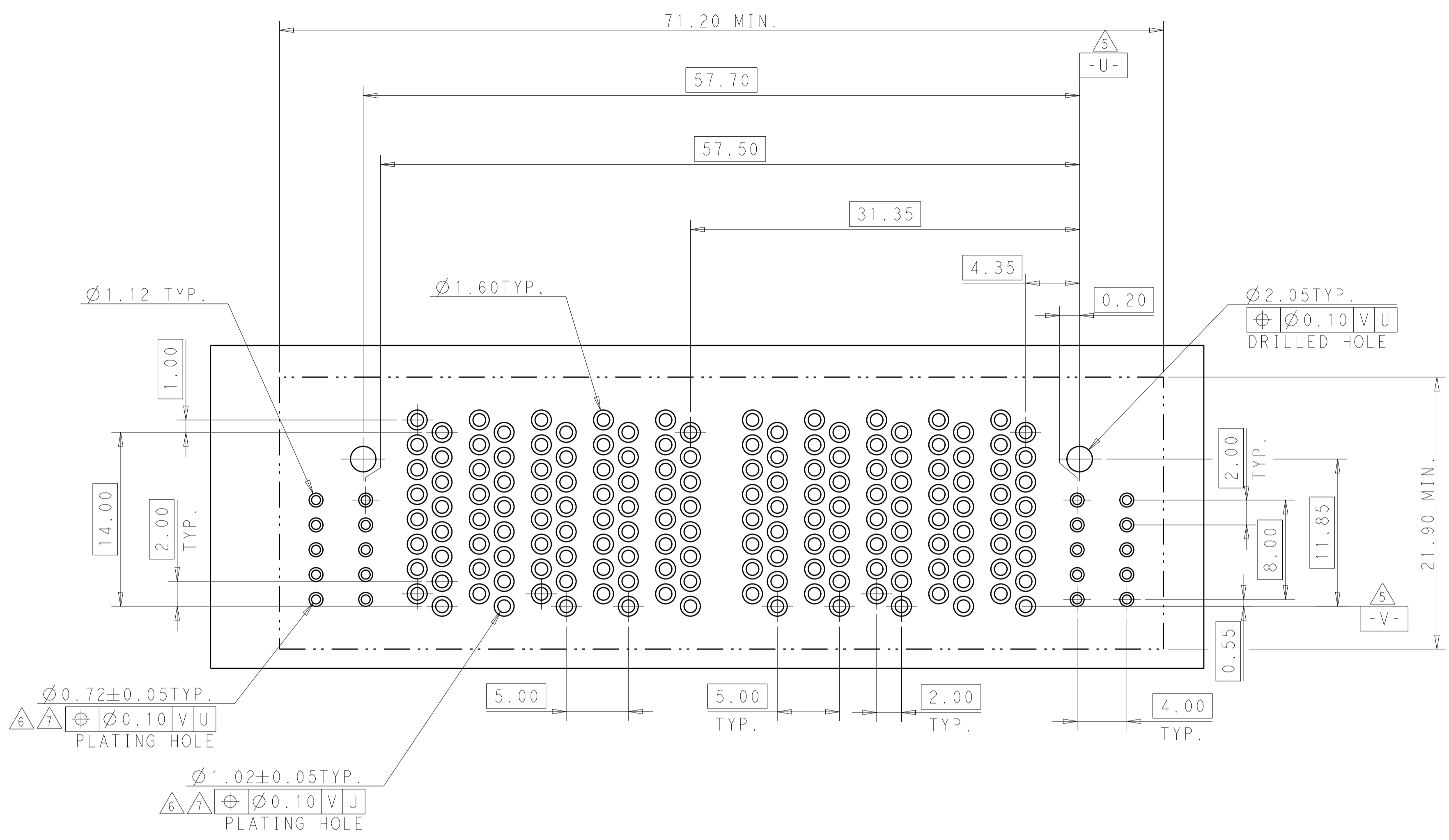

LAYOUT FOR PAR NUMBER:  
2204420-6/2204420-7

PART NUMBER	ROWS	SIGNAL		POWER								SIGNAL				
		4	3	P10	P9	P8	P7	P6	P5	P4	P3	P2	P1	2	1	
2204420-5	E	SMI	SMI	PM	PM	PM	PM	PM	PM	PM	PM	PM	SMI	SMI		
	D	SMI	SMI												SMI	SMI
	C	SMI	SMI												SMI	SMI
	B	SMI	SMI												SMI	SMI
	A	SMI	SMI												SMI	SMI
10S+5HP+5HP+10S																

PART NUMBER	ROWS	SIGNAL			POWER		SIGNAL		
		6	5	4	P2	P1	3	2	1
2204420-6	E	SMI	SMI	SMI	PM	PM	SMI	SMI	SMI
	D	SMI	SMI	SMI			SMI	SMI	SMI
	C	SMI	SMI	SMI			SMI	SMI	SMI
	B	SMI	SMI	SMI			SMI	SMI	SMI
	A	SMI	SMI	SMI			SMI	SMI	SMI
15S+1P+1P+15S									

PART NUMBER	ROWS	SIGNAL			POWER		SIGNAL		
		6	5	4	P2	P1	3	2	1
2204420-7	E	SMI	SMI	SMI	PM	PM	SMI	SMI	SMI
	D	SMI	SMI	SMI			SMI	SMI	SMI
	C	SMI	SMI	SMI			SMI	SMI	SMI
	B	SMI	SMI	SMI			SMI	SMI	SMI
	A	SMI	SMI	SMI			SMI	SMI	SMI
15S+1P+1P+12S									

THIS DRAWING IS A CONTROLLED DOCUMENT. DWG: THOMAS\_ZHAO\_20DEC2012, CHK: SUNY\_ZHAO\_20DEC2012, APVD: SUNY\_ZHAO\_20DEC2012

**STE** TE Connectivity

Customer Drawing  
VERTICAL RECEPTACLE  
MULTI-BEAM HD S+P+P+S

SIZE: A1 00779 C=2204420

SCALE: 4:1 SHEET: 6 OF 7 REV: A2

LOC	DIST	REVISIONS			
P	LTM	DESCRIPTION	DATE	DMN	APVD
-	-	SEE SHEET 1	-	-	-

PART NUMBER	ROWS	SIGNAL			POWER			SIGNAL		
		6	5	4	P3	P2	P1	3	2	1
2204420-8	E	SMI	SMI	SMI	PM	PM	PM	SMI	SMI	SMI
	D	SMI	SMI	SMI				SMI	SMI	SMI
	C	SMI	SMI	SMI				SMI	SMI	SMI
	B	SMI	SMI	SMI				SMI	SMI	SMI
	A	SMI	SMI	SMI				SMI	SMI	SMI
15S+3P+12S										

PART NUMBER	ROWS	SIGNAL			POWER						SIGNAL		
		6	5	4	P6	P5	P4	P3	P2	P1	3	2	1
2204420-9	E	SMI	SMI	SMI	PM	PM	PM	PM	PM	PM	SMI	SMI	SMI
	D	SMI	SMI	SMI							SMI	SMI	SMI
	C	SMI	SMI	SMI							SMI	SMI	SMI
	B	SMI	SMI	SMI							SMI	SMI	SMI
	A	SMI	SMI	SMI							SMI	SMI	SMI
15S+3P+3P+15S													

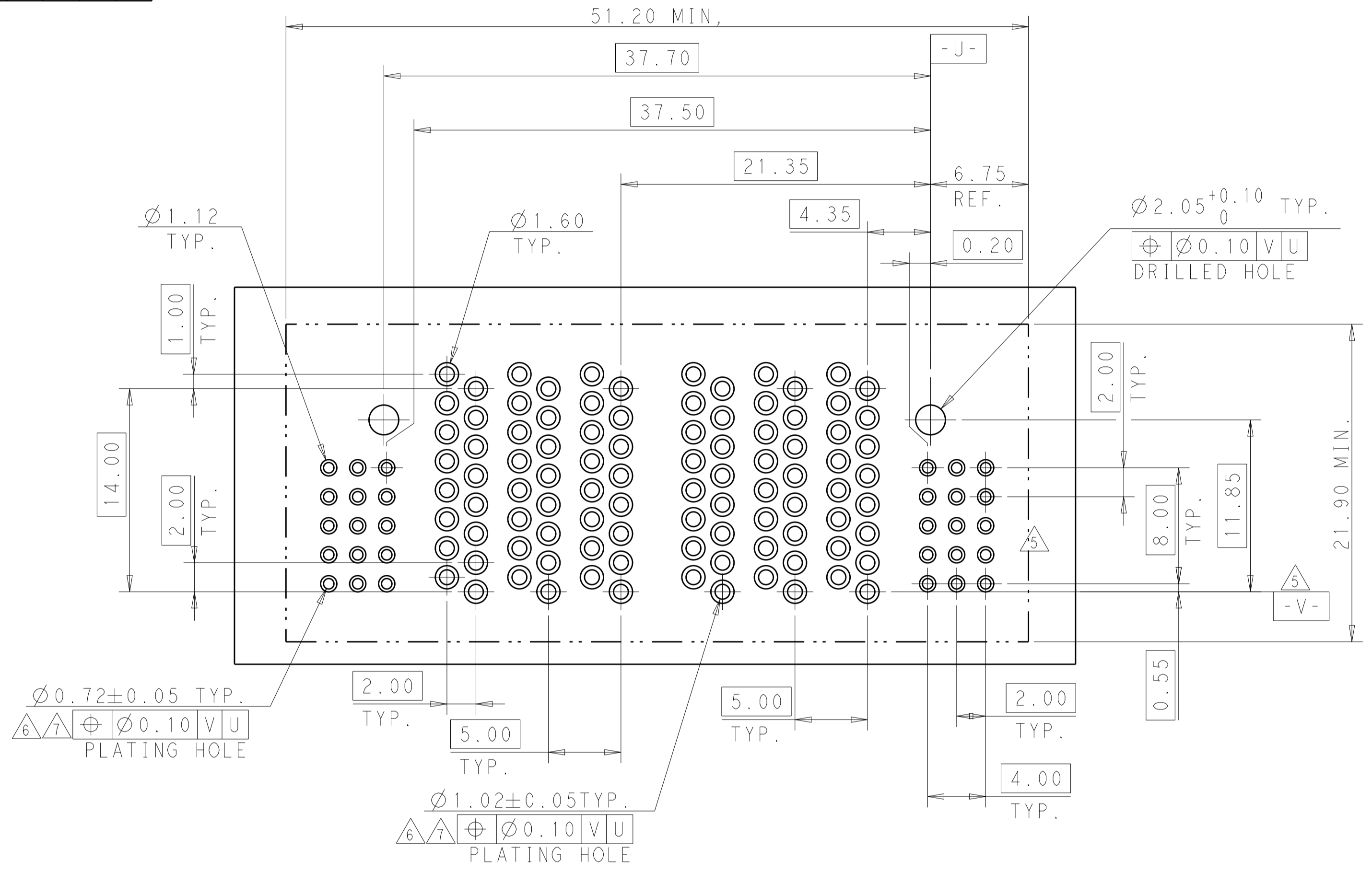
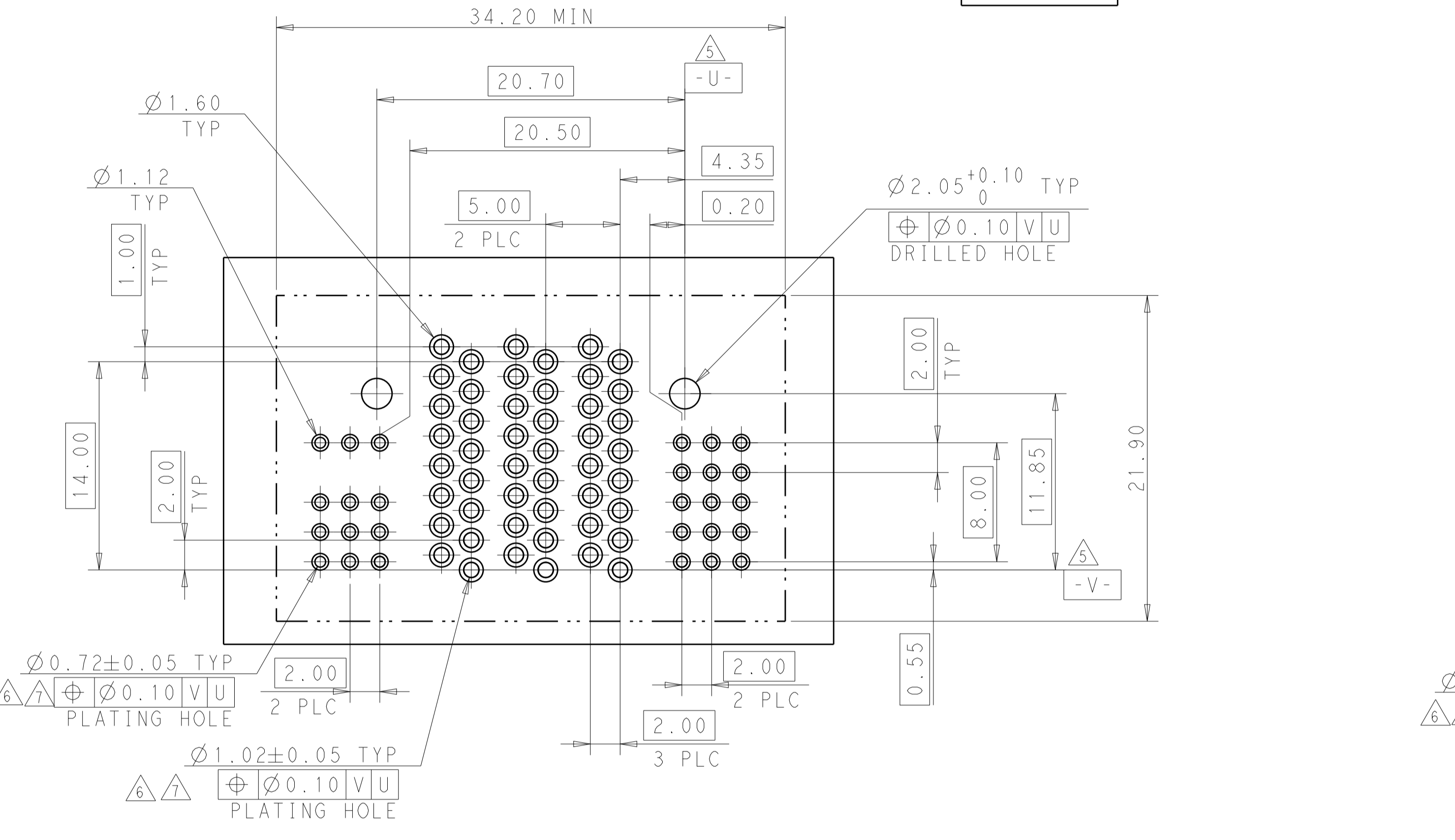

PCB LAYOUT PART NUMBER: 2204420-9/1-2204420-1

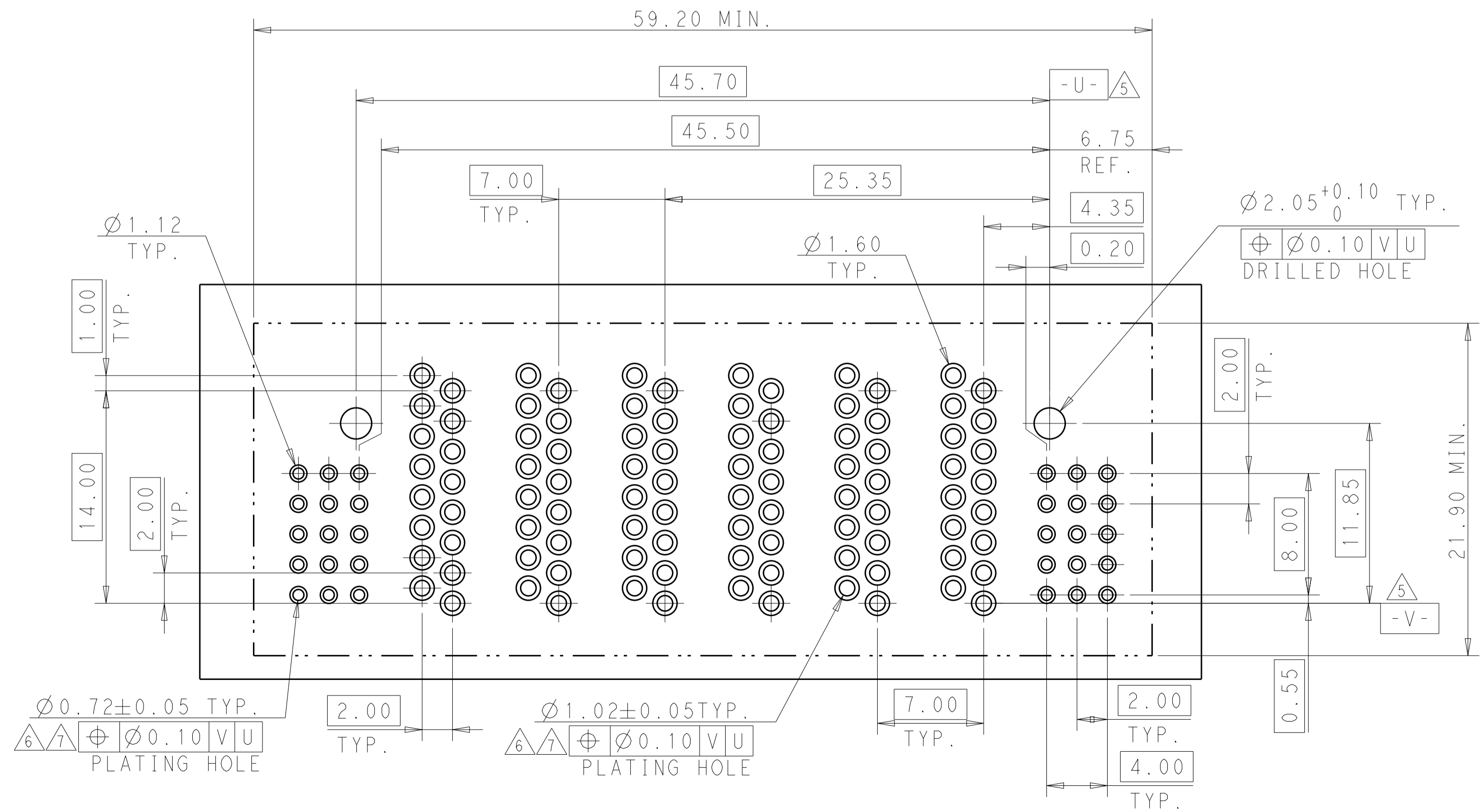

PART NUMBER	ROWS	SIGNAL			POWER						SIGNAL		
		6	5	4	P6	P5	P4	P3	P2	P1	3	2	1
1-2204420-0	E	SMI	SMI	SMI	PM	PM	PM	PM	PM	PM	SMI	SMI	SMI
	D	SMI	SMI	SMI							SMI	SMI	SMI
	C	SMI	SMI	SMI							SMI	SMI	SMI
	B	SMI	SMI	SMI							SMI	SMI	SMI
	A	SMI	SMI	SMI							SMI	SMI	SMI
15S+3HVP+3HVP+15S													

PART NUMBER	ROWS	SIGNAL			POWER						SIGNAL		
		6	5	4	P6	P5	P4	P3	P2	P1	3	2	1
1-2204420-1	E	SMI	SMI	SMI	PM	PM	PM	PN	PN	PN	SMI	SMI	SMI
	D	SMI	SMI	SMI							SMI	SMI	SMI
	C	SMI	SMI	SMI							SMI	SMI	SMI
	B	SMI	SMI	SMI							SMI	SMI	SMI
	A	SMI	SMI	SMI							SMI	SMI	SMI
15S+3P+3P+15S													

THIS DRAWING IS A CONTROLLED DOCUMENT. DWG: THOMAS\_ZHAO\_20DEC2012, CHK: SUNY\_ZHAO\_20DEC2012, APVD: SUNY\_ZHAO\_20DEC2012

TE Connectivity

Customer Drawing  
VERTICAL RECEPTACLE  
MULTI-BEAM HD S+P+P+S

SCALE: 4:1 SHEET 7 OF 7 REV: A2