

## LTM8061-4.1/LTM8061-4.2/ LTM8061-8.2/LTM8061.4 32V, 2A $\mu$ Module Li-Ion Battery Charger

### DESCRIPTION

Demonstration circuits 1645A-A, 1645A-B, 1645A-C and 1645A-D feature the LTM8061, a 32V, 2A  $\mu$ Module<sup>®</sup> Li-Ion battery charger. Operating from a 6.5V to 32V input source, the 1645A-A and 1645A-B demo circuits charge single cell Li-Ion batteries to float voltages of 4.1V or 4.2V respectively. The 1645A-C and 1645A-D demo circuits operate from a 12V to 32V input source, and charge dual cell Li-Ion battery packs to float voltages of 8.2V or 8.4V. JP1 turns the

converter on or off. JP2 allows for easy selection of C/10 or timer charge termination. The LTM8061 datasheet must be read in conjunction with this demo manual for working on or modifying the demo circuit 1645A.

**Design files for this circuit board are available at <http://www.linear.com/demo>**

LT, LT, LTC, LTM,  $\mu$ Module, Linear Technology and the Linear logo are registered trademarks of Linear Technology Corporation. All other trademarks are the property of their respective owners.

### PERFORMANCE SUMMARY

**Table 1. Typical Specifications of the Demoboard (T<sub>A</sub> = 25°C)**

Input Supply Range	6.5V to 32V (-A and -B), 12V to 32V (-C and -D)
Typical Output Current Limit for All Versions	2A
Float Voltage Accuracy	4.08V to 4.12V (-A), 4.18V to 4.22V (-B) 8.16V to -8.24V (-C), 8.36V to 8.44V (-D)

### BOARD PHOTO

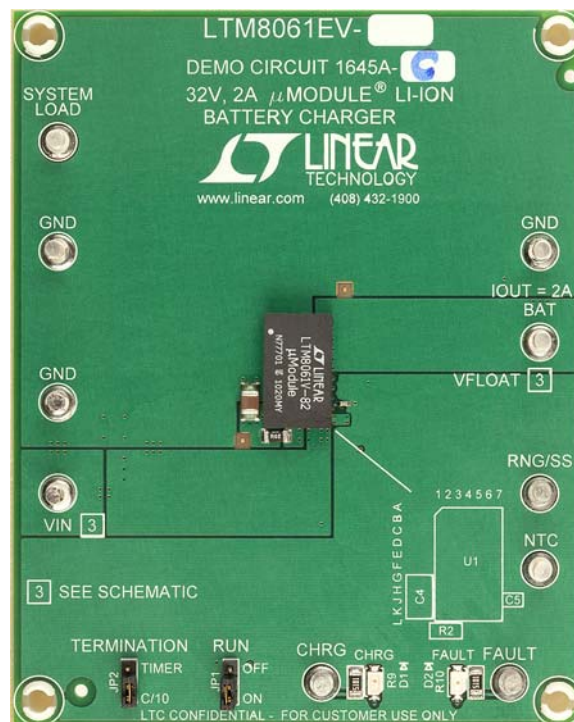

dc1645af

### QUICK START PROCEDURE

Demonstration circuits 1645A-A, 1645A-B, 1645A-C and 1645A-D are easy to set up to evaluate the performance of the LTM8061-4.1, LTM8061-4.2, LTM8061-8.2, LTM8061-8.4.

Refer to Figure 1 for proper measurement and equipment setup.

#### DC1645A-A and DC1645A-B

Follow the procedure below for demo circuits 1645A-A and 1645A-B

1. Jumper and Power Supply Setting:

JP1 = ON    PS1 = OFF

JP2 = C/10    PS2 = OFF

2. Turn on PS2 and slowly increase the voltage to 2.7V while monitoring the current into the BAT pin. If the current is less than 5mA, turn on PS1 and increase voltage to 12V.
3. Verify that the battery charging current,  $I_{BAT}$ , is between 250mA and 350mA. The CHRG LED should be on and the FAULT LED should be off.
4. Increase PS2 until  $V_{BAT}$  is 3.6V. Verify the input current,  $I_{IN}$ , is between 700mA and 850mA, the battery current,  $I_{BAT}$ , is between 1.775A and 2.225A and that the CHRG LED remains on.
5. Increase PS2 until  $V_{BAT}$  is 4.3V. Verify the battery charging current,  $I_{BAT}$ , is less than 5mA and the CHRG LED is off.
6. Decrease PS2 until  $V_{BAT}$  is 3.9V. Verify the battery current,  $I_{BAT}$ , is between 1.775A and 2.225A and the CHRG LED is on.
7. Decrease PS2 until  $V_{BAT}$  is 3.6V. Connect a 10k resistor from RNG/SS to ground. Verify the charging current,  $I_{BAT}$ , is between 850mA and 1.0A. Verify the voltage at  $V_{RNG/SS}$ , is between 450mV and 550mV. Remove the 10k resistor.
8. Set JP1 to OFF. Verify the charging current,  $I_{BAT}$ , is less than 5mA and the FAULT LED and the CHRG LED are off.

9. Set JP1 to ON. Connect a jumper from the NTC pin to ground. Verify the charging current,  $I_{BAT}$ , is less than 5mA and the FAULT LED and the CHRG LED are on.
10. Remove the jumper from NTC to ground. Verify the charging current,  $I_{BAT}$ , is between 1.775A and 2.225A, the FAULT LED is off and the CHRG LED is on.
11. This concludes the test for the A and B versions. Turn off PS1 and PS2.

#### DC1645A-C and DC1645A-D

Follow the procedure below for demo circuits -C and -D

1a. Jumper and Power Supply Setting:

JP1 = ON    PS1 = OFF

JP2 = C/10    PS2 = OFF

- 2a. Turn on PS2 and slowly increase the voltage to 5.4V while monitoring the current into the BAT pin. If the current is less than 5mA, turn on PS1 and increase voltage to 12V.
- 3a. Verify that the battery charging current,  $I_{BAT}$ , is between 250mA and 350mA. The CHRG LED should be on and the FAULT LED should be off.
- 4a. Increase PS2 until  $V_{BAT}$  is 7.2V. Verify the input current,  $I_{IN}$ , is between 1200mA and 1700mA, the battery current,  $I_{BAT}$ , is between 1.775A and 2.225A and the CHRG LED remains on.
- 5a. Increase PS2 until  $V_{BAT}$  is 8.6V. Verify the battery charging current,  $I_{BAT}$ , is less than 5mA and the CHRG LED is off.
- 6a. Decrease PS2 until  $V_{BAT}$  is 7.8V. Verify the battery current,  $I_{BAT}$ , is between 1.775A and 2.225A and that the CHRG LED is on.
- 7a. Decrease PS2 until  $V_{BAT}$  is 7.2V. Connect a 10k resistor from RNG/SS to ground. Verify the charging current,  $I_{BAT}$ , is between 800mA and 1.0A. Verify the voltage at  $V_{RNG/SS}$ , is between 450mV and 550mV. Remove the 10k resistor.

### QUICK START PROCEDURE

- 8a. Set JP1 to OFF. Verify the charging current,  $I_{BAT}$ , is less than 5mA and the FAULT LED and the CHRГ LED are off.
- 9a. Set JP1 to ON. Connect a jumper from the NTC pin to ground. Verify the charging current,  $I_{BAT}$ , is less than 5mA and the FAULT LED and the CHRГ LED are on.
- 10a. Remove the jumper from NTC to ground. Verify the charging current,  $I_{BAT}$ , is between 1.775A and 2.225A, the FAULT LED is off and the CHRГ LED is on.
- 11a. This concludes the test for the C and D versions. Turn off PS1 and PS2.

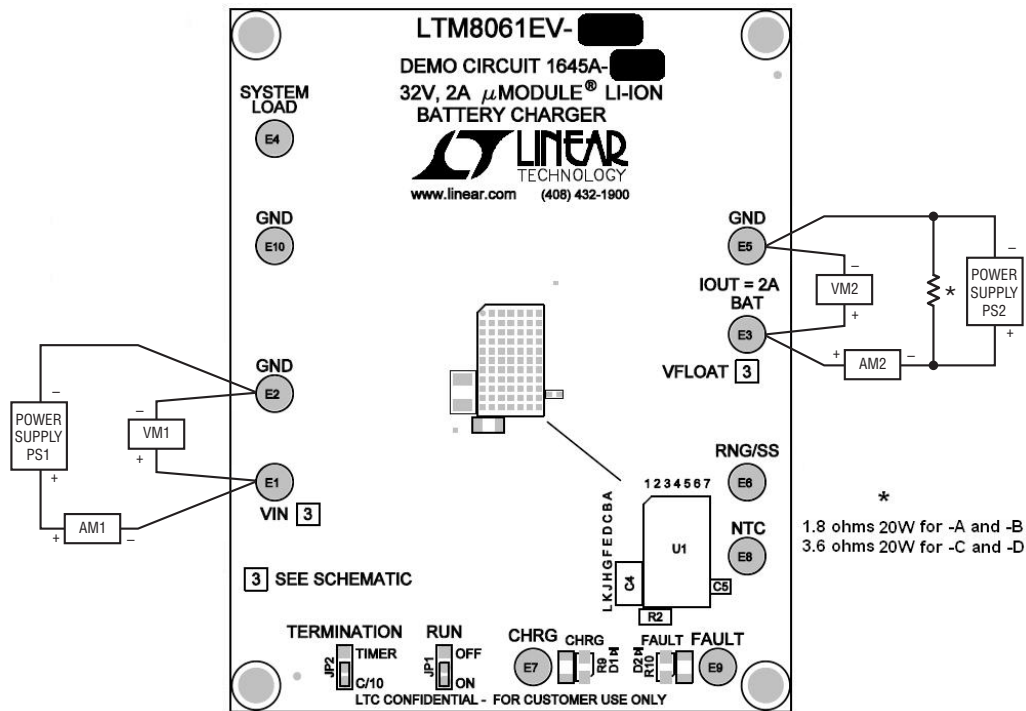

Figure 1. DC1645A Proper Equipment Setup

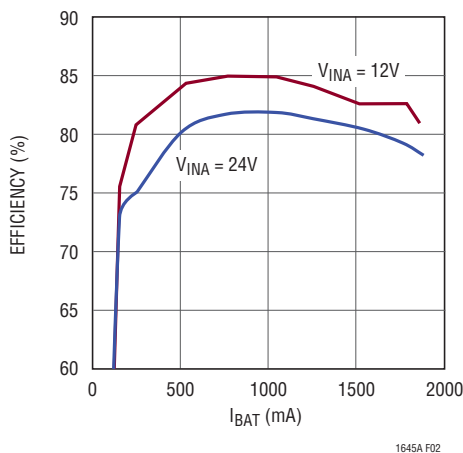

Figure 2. Efficiency vs  $I_{BAT}$ , 4.1 $V_{BAT}$

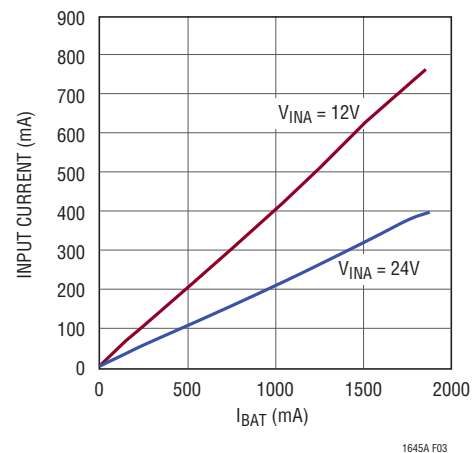

Figure 3. Input Current vs  $I_{BAT}$ , 4.1 $V_{BAT}$

# DEMO MANUAL

## DC1645A-A/DC1645A-B/ DC1645A-C/DC1645A-D

### QUICK START PROCEDURE

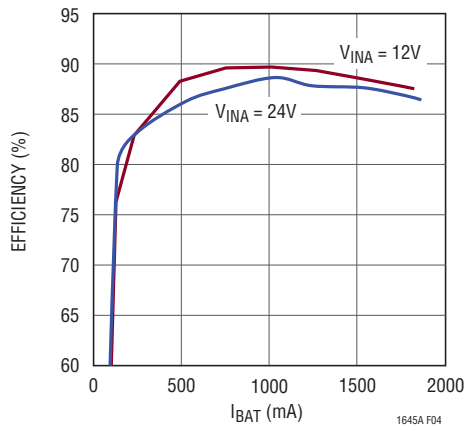

Figure 4. Efficiency vs  $I_{BAT}$ , 8.2V $_{BAT}$

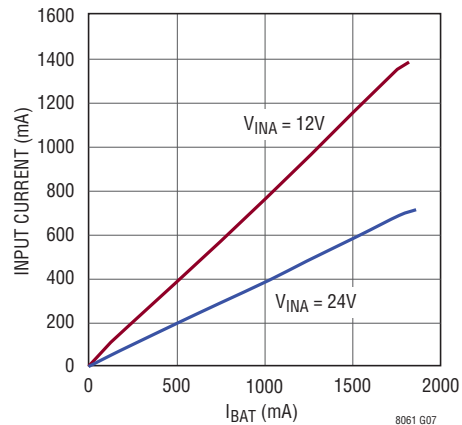
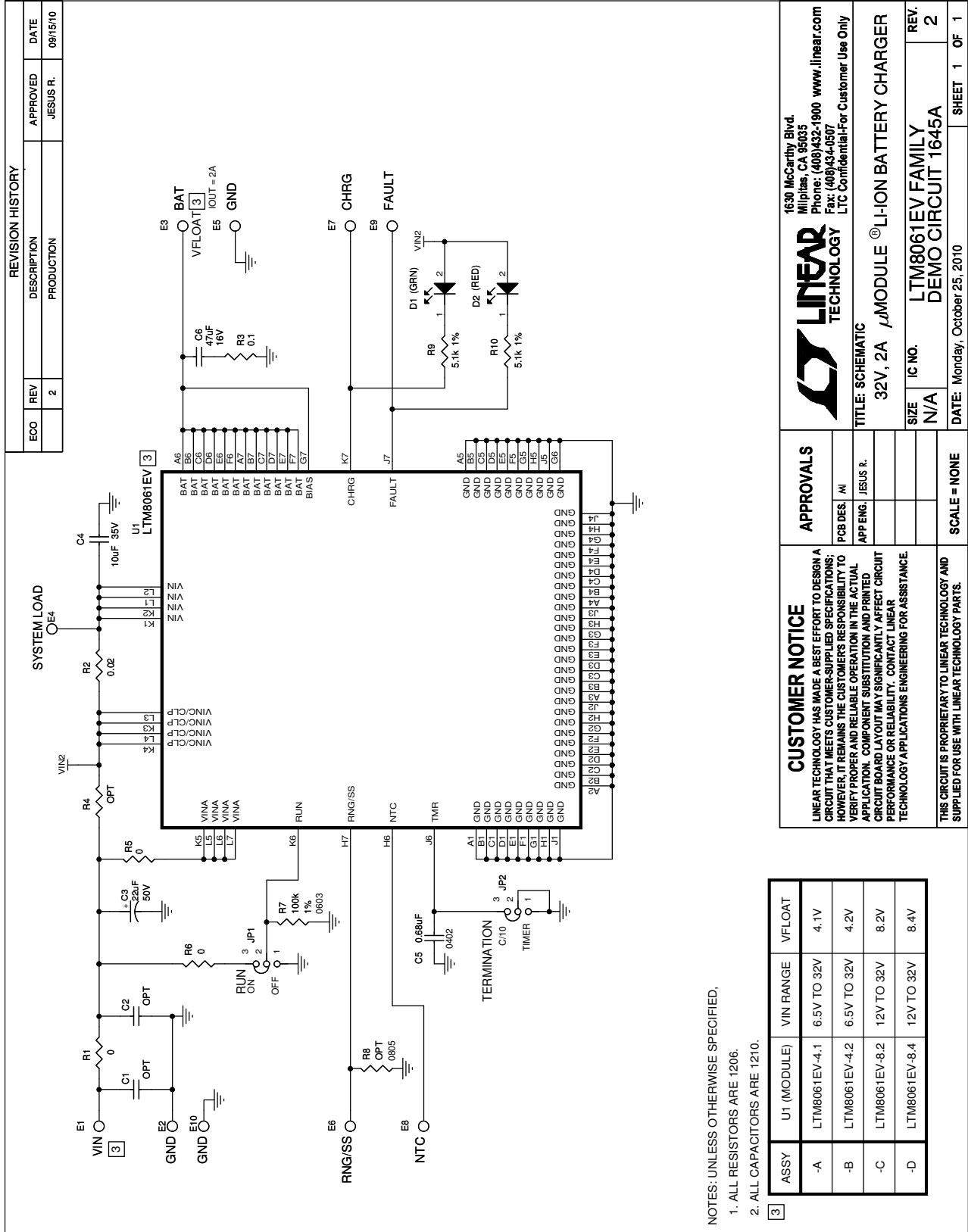

Figure 5. Input Current vs  $I_{BAT}$ , 8.2V $_{BAT}$

### PARTS LIST

ITEM	QUANTITY	REFERENCE-DESCRIPTION	DESCRIPTION	MANUFACTURERS PART NUMBER
<b>Required Circuit Components</b>				
1	1	C4	CAP, 10 $\mu$ F 10% 35V X5R, 1210	MURATA, GRM32ER7YA106KA12L
2	1	C5	CAP, 0.68 $\mu$ F 10% 10V X5R, 0402	MURATA, GRM155R61A684KE15D
3	1	C6	CAP, 47 $\mu$ F 20% 16V X5R, 1210	TAIYO YUDEN, EMK325BJ476MM-G
4	1	R2	RES, 0.02 $\Omega$ 1% 1/2W, 1206	IRC, LR1206LF-01-R020-F
5	1	R3	RES, 0.1 $\Omega$ 1% 1/2W, 1206	IRC, LRC1206-01-R100-F
6	1	U1	IC, 32V, 2A $\mu$ Module Li Ion Battery Chrager	LTM8061EV-4.1 (-A only) LTM8061EV-4.2 (-B only) LTM8061EV-8.2 (-C only) LTM8061EV-8.4 (-D only)
7	1		FAB, PRINTED CIRCUIT BOARD	DEMO CIRCUIT 1645A
<b>Additional Demo Board Circuit Components</b>				
1	0	C1,C2	CAP, 4.7 $\mu$ F 10% 50V X7R, 1210 OPT.	MURATA, GRM32ER71H475KA091B OPT
2	1	C3	CAP, 22 $\mu$ F 20% 50V	SUNCON, 50CE22BS
3	1	D1	LED, GREEN	PANASONIC, LN1351C
4	1	D2	LED, RED	PANASONIC, LN1251C
5	3	R1,R5,R6	RES, 0 $\Omega$ JUMPER, 1206	NIC, NRC12ZOTRF
6	0	R4	RES, OPT. 1206	OPTION
7	1	R7	RES, 100k 1% 1/10W, 0603	NIC, NRC06F1003TRF
8	0	R8	RES, OPT. 0805	OPTION
9	2	R9,R10	RES, 5.1k 1% 1/4W, 1206	NIC, NRC12F5101TRF
<b>Hardware For Demo Board Only</b>				
1	10	E1-E10	TURRET	MILL MAX, 2501-2-00-80-00-00-07-0
2	2	JP1, JP2	HEADER, 3-PIN, 2mm	SAMTEC, TMM-103-02-L-S
3	2	JP1, JP2	SHUNT, 2mm	SAMTEC, 2SN-BK-G
4	4		STANDOFF, SNAP ON	KEYSTONE, 8834

# SCHEMATIC DIAGRAM



1630 McCarthy Blvd.  
Milpitas, CA 95035  
Phone: (408)432-1900 www.linear.com  
Fax: (408)434-0507  
LTC Confidential-For Customer-Use Only

**LINEAR TECHNOLOGY**

TITLE: SCHEMATIC  
32V, 2A  $\mu$ MODULE  $\text{L}^{\text{TM}}$  LITHIUM BATTERY CHARGER

PCB DES. / APP ENG. / JESUS R.	SCALE = NONE
REV. 2	SHEET 1 OF 1

**CUSTOMER NOTICE**  
LINEAR TECHNOLOGY HAS MADE A BEST EFFORT TO DESIGN A CIRCUIT THAT MEETS CUSTOMER-SUPPLIED SPECIFICATIONS; HOWEVER, IT REMAINS THE CUSTOMER'S RESPONSIBILITY TO VERIFY PROPER AND RELIABLE OPERATION IN THE ACTUAL APPLICATION. COMPONENT SUBSTITUTION AND PRINTED CIRCUIT BOARD LAYOUT MAY SIGNIFICANTLY AFFECT CIRCUIT PERFORMANCE OR RELIABILITY. CONTACT LINEAR TECHNOLOGY APPLICATIONS ENGINEERING FOR ASSISTANCE.

**THIS CIRCUIT IS PROPRIETARY TO LINEAR TECHNOLOGY AND SUPPLIED FOR USE WITH LINEAR TECHNOLOGY PARTS.**

# DEMO MANUAL

## DC1645A-A/DC1645A-B/ DC1645A-C/DC1645A-D

---

### DEMONSTRATION BOARD IMPORTANT NOTICE

Linear Technology Corporation (LTC) provides the enclosed product(s) under the following **AS IS** conditions:

This demonstration board (DEMO BOARD) kit being sold or provided by Linear Technology is intended for use for **ENGINEERING DEVELOPMENT OR EVALUATION PURPOSES ONLY** and is not provided by LTC for commercial use. As such, the DEMO BOARD herein may not be complete in terms of required design-, marketing-, and/or manufacturing-related protective considerations, including but not limited to product safety measures typically found in finished commercial goods. As a prototype, this product does not fall within the scope of the European Union directive on electromagnetic compatibility and therefore may or may not meet the technical requirements of the directive, or other regulations.

If this evaluation kit does not meet the specifications recited in the DEMO BOARD manual the kit may be returned within 30 days from the date of delivery for a full refund. **THE FOREGOING WARRANTY IS THE EXCLUSIVE WARRANTY MADE BY THE SELLER TO BUYER AND IS IN LIEU OF ALL OTHER WARRANTIES, EXPRESSED, IMPLIED, OR STATUTORY, INCLUDING ANY WARRANTY OF MERCHANTABILITY OR FITNESS FOR ANY PARTICULAR PURPOSE. EXCEPT TO THE EXTENT OF THIS INDEMNITY, NEITHER PARTY SHALL BE LIABLE TO THE OTHER FOR ANY INDIRECT, SPECIAL, INCIDENTAL, OR CONSEQUENTIAL DAMAGES.**

The user assumes all responsibility and liability for proper and safe handling of the goods. Further, the user releases LTC from all claims arising from the handling or use of the goods. Due to the open construction of the product, it is the user's responsibility to take any and all appropriate precautions with regard to electrostatic discharge. Also be aware that the products herein may not be regulatory compliant or agency certified (FCC, UL, CE, etc.).

No License is granted under any patent right or other intellectual property whatsoever. **LTC assumes no liability for applications assistance, customer product design, software performance, or infringement of patents or any other intellectual property rights of any kind.**

LTC currently services a variety of customers for products around the world, and therefore this transaction **is not exclusive**.

**Please read the DEMO BOARD manual prior to handling the product.** Persons handling this product must have electronics training and observe good laboratory practice standards. **Common sense is encouraged.**

This notice contains important safety information about temperatures and voltages. For further safety concerns, please contact a LTC application engineer.

Mailing Address:

Linear Technology  
1630 McCarthy Blvd.  
Milpitas, CA 95035

Copyright © 2004, Linear Technology Corporation