



# AK2970

## Zero Drift Operational Amplifier

### 1. General Description

AK2970 is the dual channel CMOS operational amplifiers which is available to output with very low input offset voltage ( $\pm 5\mu\text{V}@10\text{V}$ ) and near zero input offset drift.

It's operated with very small current consumptions, 2mA typ. (VDD:10V), which is available to operate full swing signals in output. AK2970 is appropriate to Sensor Pre Amp. applications.

### 2. Features

- Wide Supply Operation Range: 4.5V ~ 13.2V ( $\pm 2.25\text{V} \sim \pm 6.6\text{V}$ )
- Very Low Input Offset Voltage :  $\pm 5\mu\text{V}$  max. (@VDD:10V)
- Near Zero Drift over time and temperature :  $\pm 20\text{nV}/^\circ\text{C}$  max. (@VDD:10V)
- Input Voltage Range : VSS – VDD
- Full Swing Outputs to 10k $\Omega$  Load
- Power Supply Current : 2mA typ. (@VDD: 10V, No Load)
- Gain Bandwidth : 4MHz typ.
- Slew Rate : 4V/ $\mu\text{sec}$  typ.
- Operating Temperature Range :  $-40 \sim 125^\circ\text{C}$
- Package : MSOP8

Part Name	Channel Number	Package
AK2970H	2	MSOP8

### 3. Block Diagram

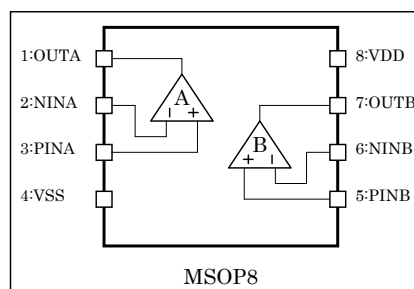

(AK2970)

#### 4. Pin Configurations and Functions

Pin number	Pin Name	I/O : Note 1	Function
1	OUTA	AO	Amplifier A Output
2	NINA	AI	Amplifier A Inverted Input
3	PINA	AI	Amplifier A No Inverted Input
4	VSS	PWR	Power Supply Ground
5	PINB	AI	Amplifier B No Inverted Input
6	NINB	AI	Amplifier B Inverted Input
7	OUTB	AO	Amplifier B Output
8	VDD	PWR	Positive Power Supply

Note 1.

PWR : Power Supply  
 AI : Analog Input  
 AO : Analog Output

#### 5. Absolute Maximum Ratings

(VSS = 0V : Note 2)

Parameter	Symbol	Min	Max	Units
Supply Voltage	VDD	-0.3	14	V
Input Voltage	V <sub>TD</sub>	-0.3	VDD + 0.3	V
Input Current	I <sub>IN</sub>	-10	+10	mA
Storage Temperature Range	T <sub>stg</sub>	-55	150	°C

Note 2. All voltage with respect to ground

Note 3. Operational at or beyond these limits may result in permanent damage to the device. Normal operation is not guaranteed at these extremes.

#### 6. Recommended Operating Conditions

Parameter	Symbol	Min.	Typ.	Max.	Units	Conditions
Operating Temperature Range	T <sub>a</sub>	-40		125	°C	
Supply Voltage	VDD	4.5		13.2	V	

## 7. Electrical Characteristics

□ DC Characteristics ( typical condition is VDD=10V,Ta=25°C )

VDD:10V, Vcm=VDD/2, Ta:-40 to 125°C, unless otherwise noted

Parameter	Symbol	Conditions	min	Typ	Max	Units
Input Voltage Offset	V <sub>IO</sub>	Ta=25°C,inverting-amp, gain@60dB		±1	±5	μV
		VDD:10V,all temperature range, inverting-amp, gain@60dB			±5	μV
		VDD≥5V,All temperature Inverting amp@60dB			±10	μV
		VDD≥4.5V,All temperature Inverting amp@60dB			±20	μV
Input Voltage Offset Drift	V <sub>IOD</sub>	Inverting amp@60dB		±5	±20	nV/°C
		VDD≥6V Inverting-amp@60dB			±40	nV/°C
		VDD≥5V Inverting-amp@60dB			±50	nV/°C
		Vdd≥4.5V, Inverting-amp@60dB			±70	nV/°C
Input Bias Current	I <sub>S</sub>	Ta=25°C (@1/2*VDD) Rf=510kΩ : Note 4		±50		pA
Input Common Mode Range	V <sub>ICM</sub>		VSS		VDD	V
Output Voltage Swing	V <sub>OM</sub>	R <sub>L</sub> ≥10kΩ (@1/2*VDD)	0.1		VDD-0.1	V
CMRR	CMR	@Common mode rage	110	130		dB
		VDD≥5V @ Common mode rage	105			dB
		VDD≥4.5V @ Common mode rage	85			dB
		VDD≥4.5V @(VSS~[VDD-0.1])	100			dB
PSRR	SVR	VDD:4.5V ~ 13.2V	110	130		dB
Large Signal Voltage Gain	A <sub>v</sub>	R <sub>L</sub> ≥10kΩ (@1/2*VDD) @Max. output range	110	130		dB
Short Circuit Current	I <sub>OS</sub>	Short Vout and VDD or VSS, by voltage follower		±50		mA
		Short Vout and VDD or VSS, by voltage follower VDD:13.2V			±180	mA
Output Current	I <sub>OS</sub>	Vcm:VSS@out [VSS+1V] Vcm:VDD@out [VDD-1V]		±15		mA
		VDD:4.5V	±5			mA
Power Supply Current	I <sub>DD</sub>	VDD:10V :Note 5		1.0	1.8	mA/ch
		VDD:4.5 ~ 13.2V :Note 5		1.0	2.5	mA/ch

Note 4. It is defined by "offset voltage (V<sub>off</sub>)" of transformer impedance amplifier. When beedback resistor is R<sub>f</sub>. Input bias current is expressed by a following formula.  $I_s = V_{off}/R_f$

When using it as transformer impedance amplifier, "V<sub>COM</sub>=VDD/2" are recommended.

Note 5. It does not contain output drive current.

■ Analog AC Characteristics (typ. value condition : VDD=10V, Ta=25°C)

VDD=10V、Vcm=VDD/2、Ta:-40~125°C, unless otherwise noted

項目	記号	条件	min	Typ	max	単位
Gain Band Width	GB	Inverting-amp@60dB Load cap.= 20pF		4		MHz
		VDD:13.2V			6.5	MHz
		VDD:4.5V	3			MHz
Slew rate	SR	Av =1, Load cap.=20pF, 10%↔90%		4		V/μs
		VDD:13.2V			10	V/μs
		VDD:4.5V	1.7			V/μs
Voltage Noise Density	VNI	@1kHz		50		nVrms/√Hz
		0.1~10Hz :Note 6		0.8		μVpp
		0.1~1Hz :Note 6		0.3		μVpp
Overload Recovery Time	TOR	Av:-50 times, Load capacitance: 20pF, 200mV input, VDD:10V, ±10% attainment time of the last value		10		μsec
Input Capacitance	Differential	CIND		1.5		pF
	Common Mode	CINC		5		pF
Maximum Capacitance Loads	CL				150	pF

Note 6. It was converted from noise density.

<Reference information>

- When output load=150pF, phase margin = 70deg typ.
- Chopper clock frequency : 10kHz typ.

**8. Typical Operating Characteristics (Reference)**

■ Supply Current vs. Temperature (Vin:1/2VDD)

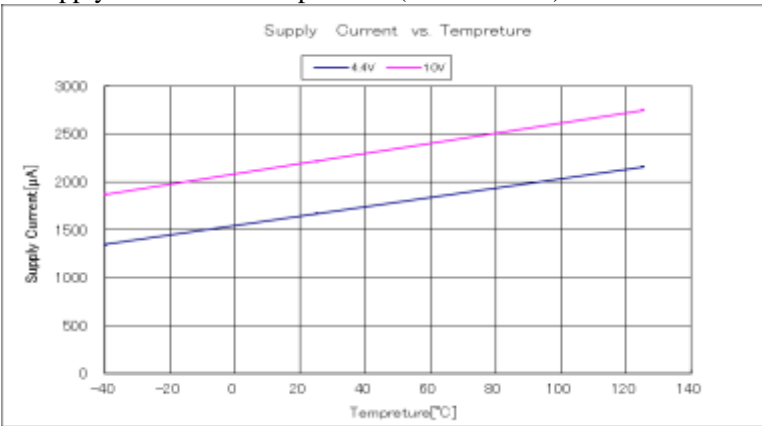

■ Supply Current vs. VDD (Vin:1/2VDD)

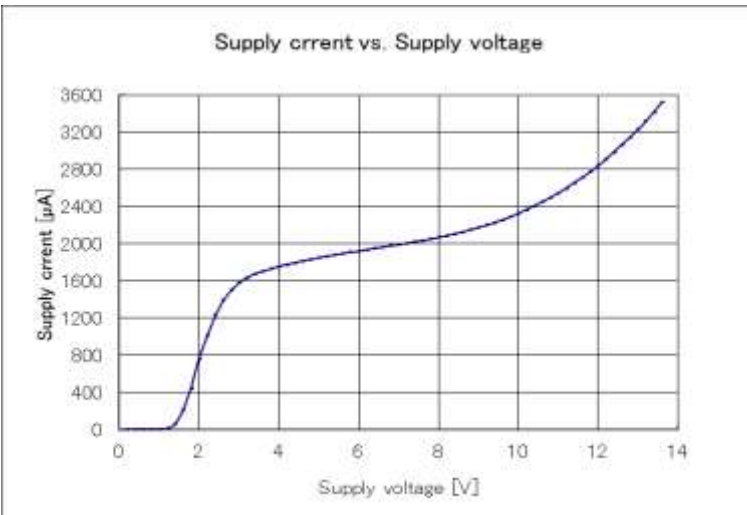

■ Closed loop gain vs. frequency (VDD=4.4V, Ta=25°C)

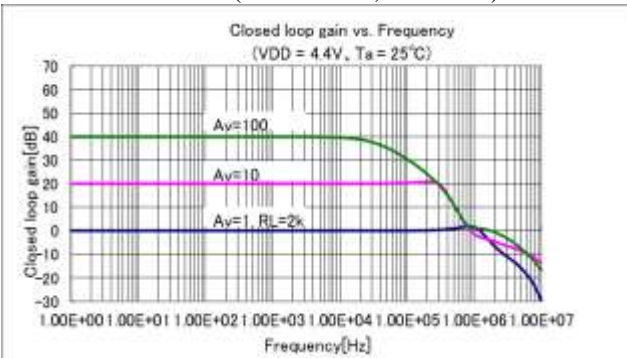

■ Closed loop gain vs. frequency (VDD=10V, Ta=25°C)

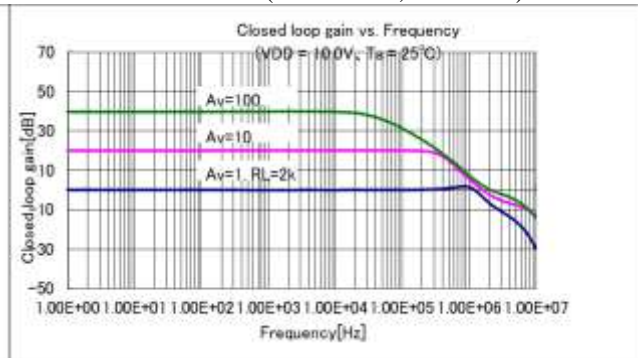

■ Short circuit current vs. Temperature (VDD=±2.2V)

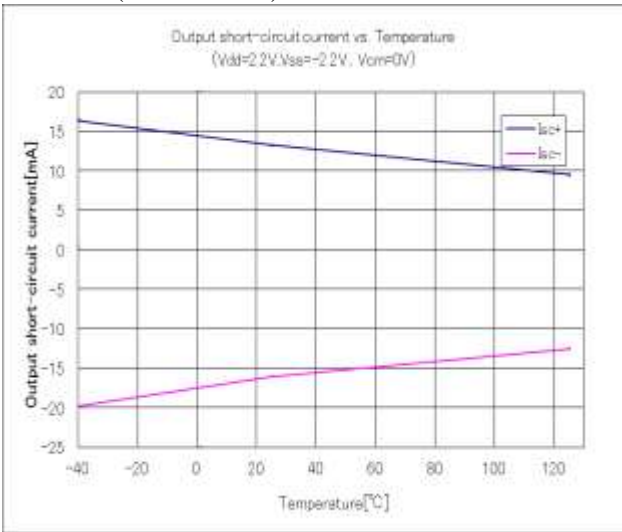

■ Short circuit current vs. Temperature (VDD=±5V)

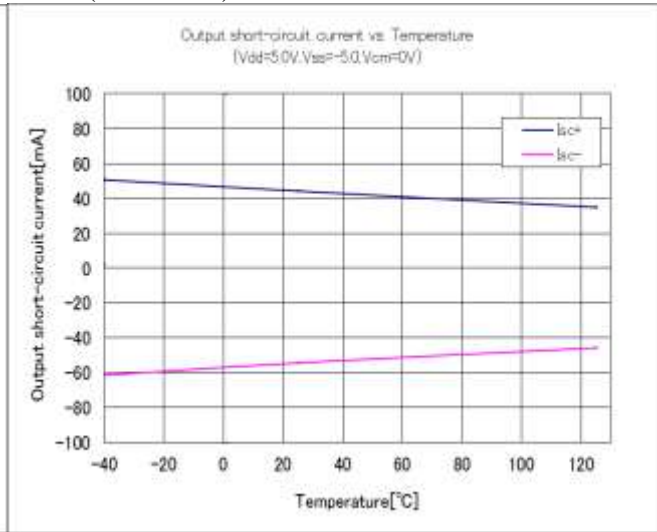

■ Power consumption distribution

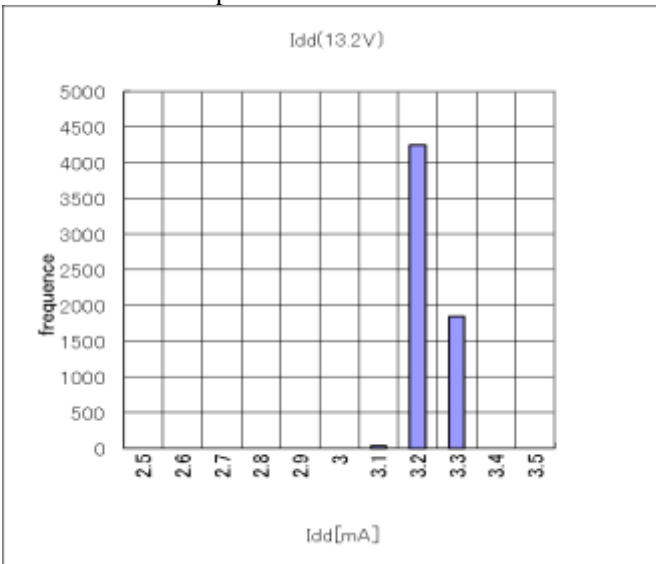

■ Offset distribution

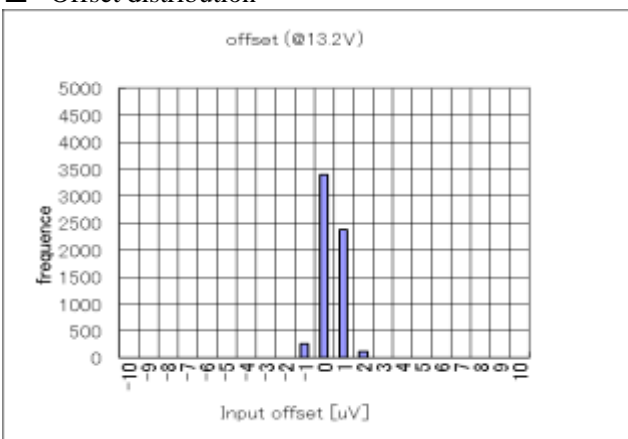

■ Offset vs. Temperature

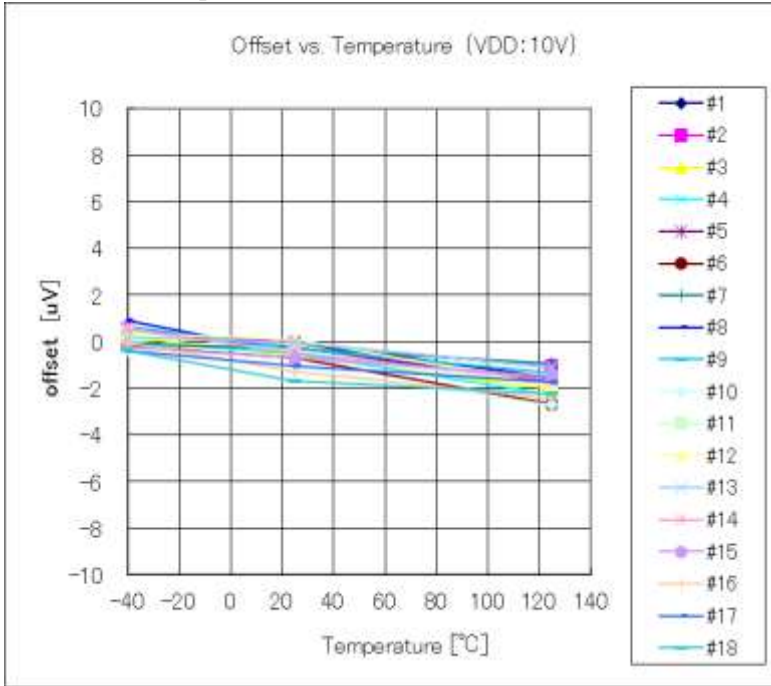

■ Common Mode Rejection Ratio vs. Frequency

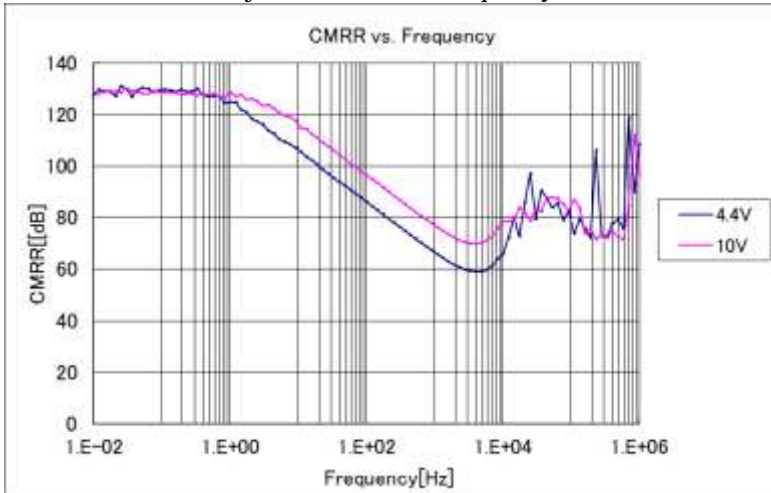

■ Power Supply Rejection Ratio vs. Frequency  
(VDD=4.4V, Ta=25°C)

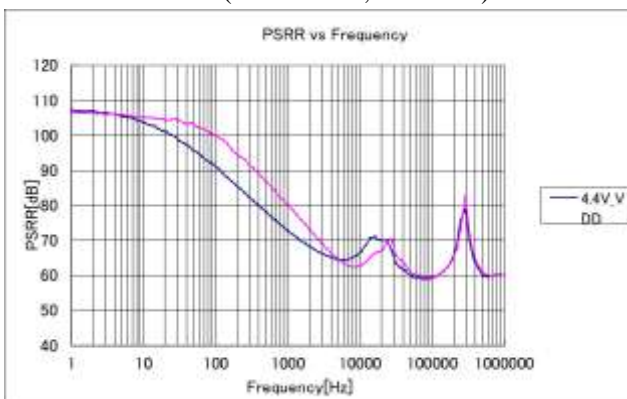

■ Power Supply Rejection Ratio vs. Frequency  
(VDD=10V, Ta=25°C)

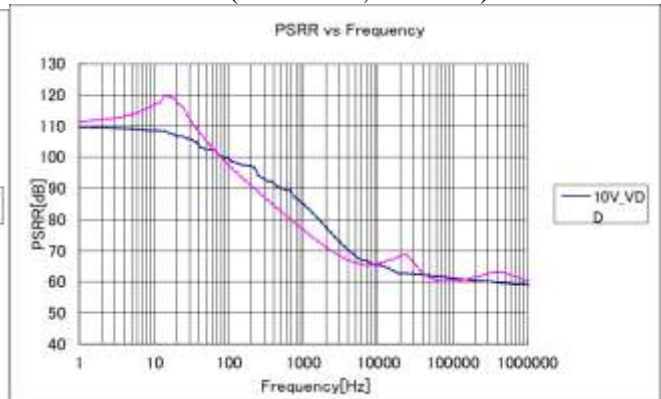

■ Power Supply Rejection Ratio vs. Temperature  
(VDD=4.4V, Ta=25°C)

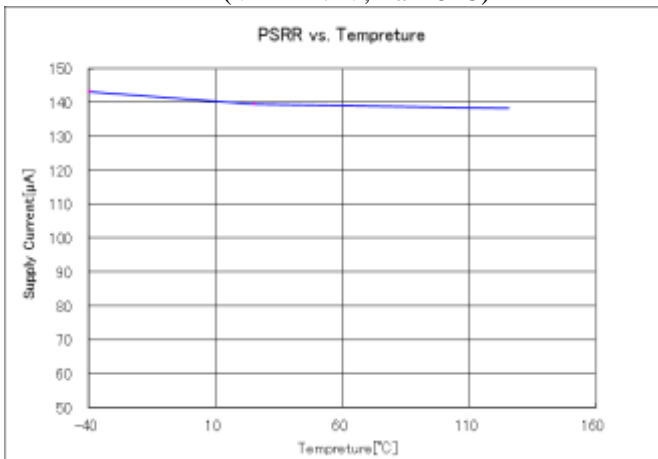

■ Voltage noise density  
(VDD=10V, Ta=25°C, f=0~10kHz)

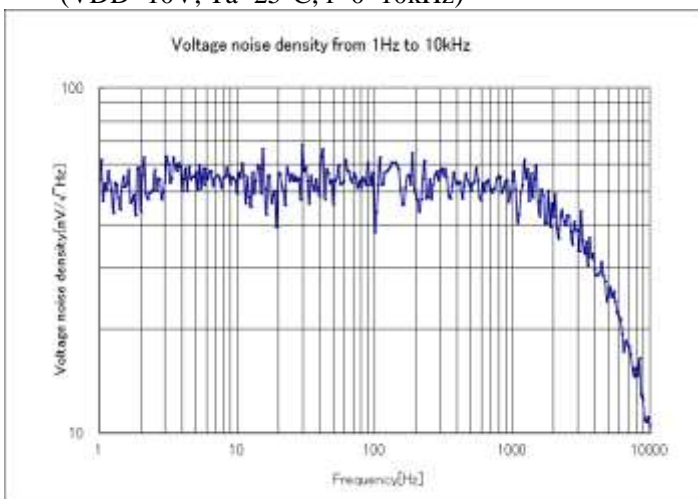



**9. Package**

9.1. Outline Dimensions

( unit : mm )

MSOP8

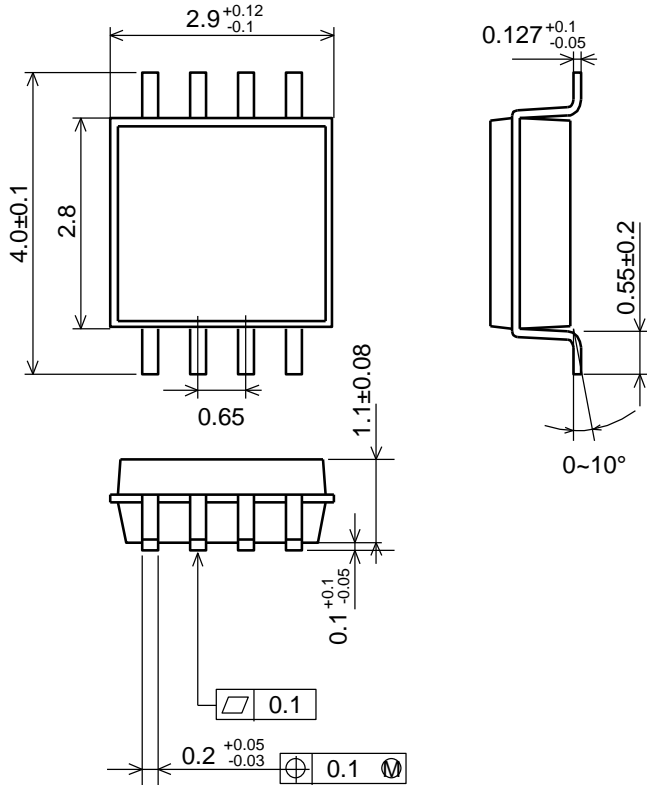

9.2. Marking

MSOP8

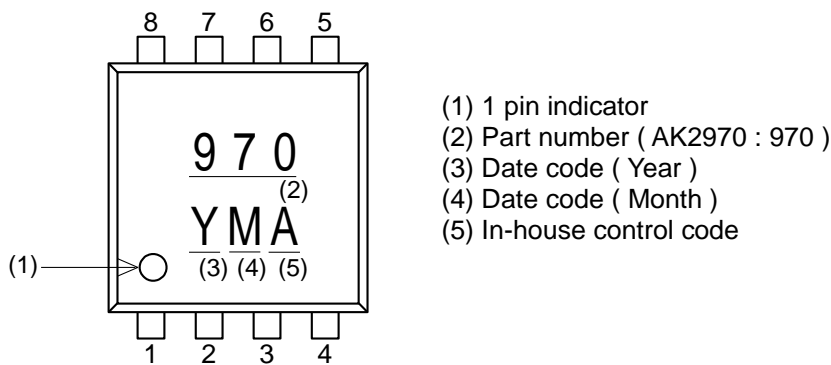

## IMPORTANT NOTICE

- These products and their specifications are subject to change without notice. When you consider any use or application of these products, please make inquiries the sales office of Asahi Kasei Microdevices Corporation (AKM) or authorized distributors as to current status of the products.
- Descriptions of external circuits, application circuits, software and other related information contained in this document are provided only to illustrate the operation and application examples of the semiconductor products. You are fully responsible for the incorporation of these external circuits, application circuits, software and other related information in the design of your equipments. AKM assumes no responsibility for any losses incurred by you or third parties arising from the use of these information herein. AKM assumes no liability for infringement of any patent, intellectual property, or other rights in the application or use of such information contained herein.
- Any export of these products, or devices or systems containing them, may require an export license or other official approval under the law and regulations of the country of export pertaining to customs and tariffs, currency exchange, or strategic materials.
- AKM products are neither intended nor authorized for use as critical components<sup>Note1)</sup> in any safety, life support, or other hazard related device or system<sup>Note2)</sup>, and AKM assumes no responsibility for such use, except for the use approved with the express written consent by Representative Director of AKM. As used here:
  - Note1) A critical component is one whose failure to function or perform may reasonably be expected to result, whether directly or indirectly, in the loss of the safety or effectiveness of the device or system containing it, and which must therefore meet very high standards of performance and reliability.
  - Note2) A hazard related device or system is one designed or intended for life support or maintenance of safety or for applications in medicine, aerospace, nuclear energy, or other fields, in which its failure to function or perform may reasonably be expected to result in loss of life or in significant injury or damage to person or property.
- It is the responsibility of the buyer or distributor of AKM products, who distributes, disposes of, or otherwise places the product with a third party, to notify such third party in advance of the above content and conditions, and the buyer or distributor agrees to assume any and all responsibility and liability for and hold AKM harmless from any and all claims arising from the use of said product in the absence of such notification.