

High Voltage, High Gain BIMOSFET™ Monolithic Bipolar MOS Transistor

IXBH20N300 IXBT20N300

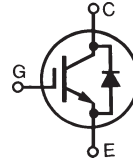

$$V_{CES} = 3000V$$

$$I_{C110} = 20A$$

$$V_{CE(sat)} \leq 3.2V$$

| Symbol | Test Conditions | Maximum Ratings | |
|-------------------------------|--|------------------------|------------|
| V_{CES} | $T_C = 25^\circ C$ to $150^\circ C$ | 3000 | V |
| V_{CGR} | $T_J = 25^\circ C$ to $150^\circ C$, $R_{GE} = 1M\Omega$ | 3000 | V |
| V_{GES} | Continuous | ± 20 | V |
| V_{GEM} | Transient | ± 30 | V |
| I_{C25} | $T_C = 25^\circ C$ | 50 | A |
| I_{C110} | $T_C = 110^\circ C$ | 20 | A |
| I_{CM} | $T_C = 25^\circ C$, 1ms | 140 | A |
| SSOA (RBSOA) | $V_{GE} = 15V$, $T_{VJ} = 125^\circ C$, $R_G = 20\Omega$ Clamped Inductive Load | $I_{CM} = 130$ 1500 | A V |
| P_C | $T_C = 25^\circ C$ | 250 | W |
| T_J | | -55 ... +150 | $^\circ C$ |
| T_{JM} | | 150 | $^\circ C$ |
| T_{stg} | | -55 ... +150 | $^\circ C$ |
| T_L | 1.6mm (0.062 in.) from Case for 10s | 300 | $^\circ C$ |
| T_{SOLD} | Plastic Body for 10 seconds | 260 | $^\circ C$ |
| M_d | Mounting Torque (TO-247) | 1.13/10 | Nm/lb.in. |
| Weight | TO-247 | 6 | g |
| | TO-268 | 4 | g |

TO-268 (IXBT)

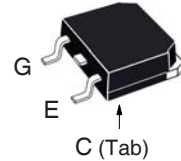

TO-247 (IXBH)

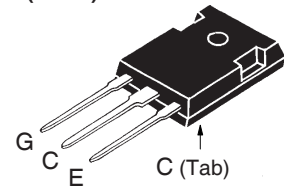

G = Gate C = Collector
E = Emitter Tab = Collector

| Symbol | Test Conditions | Characteristic Values | | |
|---------------|---|-----------------------|------------|----------------------|
| | | Min. | Typ. | Max. |
| BV_{CES} | $I_C = 250\mu A$, $V_{GE} = 0V$ | 3000 | | V |
| $V_{GE(th)}$ | $I_C = 250\mu A$, $V_{CE} = V_{GE}$ | 2.5 | | V |
| I_{CES} | $V_{CE} = 0.8 \cdot V_{CES}$, $V_{GE} = 0V$ $T_J = 125^\circ C$ | | | 35 μA 1.5 mA |
| I_{GES} | $V_{CE} = 0V$, $V_{GE} = \pm 20V$ | | | ± 100 nA |
| $V_{CE(sat)}$ | $I_C = 20A$, $V_{GE} = 15V$, Note 1 $T_J = 125^\circ C$ | | 2.7 3.2 | V V |

Features

- High Blocking Voltage
- Anti-Parallel Diode
- International Standard Packages
- Low Conduction Losses

Advantages

- Low Gate Drive Requirement
- High Power Density

Applications:

- Switch-Mode and Resonant-Mode Power Supplies
- Uninterruptible Power Supplies (UPS)
- Laser Generators
- Capacitor Discharge Circuits
- AC Switches

Symbol Test Conditions

($T_J = 25^\circ\text{C}$ Unless Otherwise Specified)

Characteristic Values

| | | Min. | Typ. | Max. | |
|--------------|--|------|------|------|--------------------|
| g_{fS} | $I_C = 20\text{A}, V_{CE} = 10\text{V}, \text{Note 1}$ | 11 | 18 | | S |
| C_{ies} | $V_{CE} = 25\text{V}, V_{GE} = 0\text{V}, f = 1\text{MHz}$ | | 2230 | | pF |
| C_{oes} | | | 92 | | pF |
| C_{res} | | | 33 | | pF |
| Q_g | $I_C = 20\text{A}, V_{GE} = 15\text{V}, V_{CE} = 1000\text{V}$ | | 105 | | nC |
| Q_{ge} | | | 13 | | nC |
| Q_{gc} | | | 45 | | nC |
| $t_{d(on)}$ | Resistive Switching Times, $T_J = 25^\circ\text{C}$ $I_C = 20\text{A}, V_{GE} = 15\text{V}$ $V_{CE} = 1250\text{V}, R_G = 10\Omega$ | | 64 | | ns |
| t_r | | | 210 | | ns |
| $t_{d(off)}$ | | | 300 | | ns |
| t_f | | | 504 | | ns |
| $t_{d(on)}$ | Resistive Switching Times, $T_J = 125^\circ\text{C}$ $I_C = 20\text{A}, V_{GE} = 15\text{V}$ $V_{CE} = 1250\text{V}, R_G = 10\Omega$ | | 68 | | ns |
| t_r | | | 540 | | ns |
| $t_{d(off)}$ | | | 300 | | ns |
| t_f | | | 395 | | ns |
| R_{thJC} | | | | 0.50 | $^\circ\text{C/W}$ |
| R_{thCS} | (TO-247) | | 0.21 | | $^\circ\text{C/W}$ |

Reverse Diode

Symbol Test Conditions

($T_J = 25^\circ\text{C}$ Unless Otherwise Specified)

Characteristic Values

| | | Min. | Typ. | Max. | |
|----------|--|---|------|------|---------------|
| V_F | $I_F = 20\text{A}, V_{GE} = 0\text{V}$ | | | 2.1 | V |
| t_{rr} | $I_F = 10\text{A}, V_{GE} = 0\text{V}, -di_F/dt = 100\text{A}/\mu\text{s}$ | | 1.35 | | μs |
| I_{RM} | | $V_R = 100\text{V}, V_{GE} = 0\text{V}$ | | 30 | |

Note 1: Pulse test, $t \leq 300\mu\text{s}$, duty cycle, $d \leq 2\%$.

TO-268 Outline

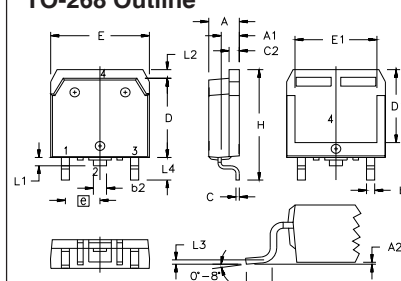

Terminals: 1 - Gate
3 - Emitter
2,4 - Collector

| SYM | INCHES | | MILLIMETERS | |
|-----|----------|------|-------------|-------|
| | MIN | MAX | MIN | MAX |
| A | .193 | .201 | 4.90 | 5.10 |
| A1 | .106 | .114 | 2.70 | 2.90 |
| A2 | .001 | .010 | 0.02 | 0.25 |
| b | .045 | .057 | 1.15 | 1.45 |
| b2 | .075 | .083 | 1.90 | 2.10 |
| C | .016 | .026 | 0.40 | 0.65 |
| C2 | .057 | .063 | 1.45 | 1.60 |
| D | .543 | .551 | 13.80 | 14.00 |
| D1 | .488 | .500 | 12.40 | 12.70 |
| E | .624 | .632 | 15.85 | 16.05 |
| E1 | .524 | .535 | 13.30 | 13.60 |
| e | .215 BSC | | 5.45 BSC | |
| H | .736 | .752 | 18.70 | 19.10 |
| L | .094 | .106 | 2.40 | 2.70 |
| L1 | .047 | .055 | 1.20 | 1.40 |
| L2 | .039 | .045 | 1.00 | 1.15 |
| L3 | .010 BSC | | 0.25 BSC | |
| L4 | .150 | .161 | 3.80 | 4.10 |

TO-247 Outline

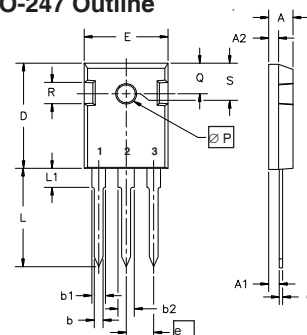

Terminals: 1 - Gate
3 - Emitter
2 - Collector

| Dim. | Millimeter | | Inches | |
|----------------|------------|-------|---------|-------|
| | Min. | Max. | Min. | Max. |
| A | 4.7 | 5.3 | .185 | .209 |
| A ₁ | 2.2 | 2.54 | .087 | .102 |
| A ₂ | 2.2 | 2.6 | .059 | .098 |
| b | 1.0 | 1.4 | .040 | .055 |
| b ₁ | 1.65 | 2.13 | .065 | .084 |
| b ₂ | 2.87 | 3.12 | .113 | .123 |
| C | .4 | .8 | .016 | .031 |
| D | 20.80 | 21.46 | .819 | .845 |
| E | 15.75 | 16.26 | .610 | .640 |
| e | 5.20 | 5.72 | 0.205 | 0.225 |
| L | 19.81 | 20.32 | .780 | .800 |
| L1 | | 4.50 | | .177 |
| ∅P | 3.55 | 3.65 | .140 | .144 |
| Q | 5.89 | 6.40 | 0.232 | 0.252 |
| R | 4.32 | 5.49 | .170 | .216 |
| S | 6.15 BSC | | 242 BSC | |

IXYS Reserves the Right to Change Limits, Test Conditions and Dimensions.

IXYS MOSFETs and IGBTs are covered by one or more of the following U.S. patents:

| | | | | | | | | | |
|-----------|-----------|-----------|-----------|--------------|--------------|--------------|--------------|--------------|-------------|
| 4,835,592 | 4,931,844 | 5,049,961 | 5,237,481 | 6,162,665 | 6,404,065 B1 | 6,683,344 | 6,727,585 | 7,005,734 B2 | 7,157,338B2 |
| 4,860,072 | 5,017,508 | 5,063,307 | 5,381,025 | 6,259,123 B1 | 6,534,343 | 6,710,405 B2 | 6,759,692 | 7,063,975 B2 | |
| 4,881,106 | 5,034,796 | 5,187,117 | 5,486,715 | 6,306,728 B1 | 6,583,505 | 6,710,463 | 6,771,478 B2 | 7,071,537 | |

Fig. 1. Output Characteristics @ $T_J = 25^\circ\text{C}$

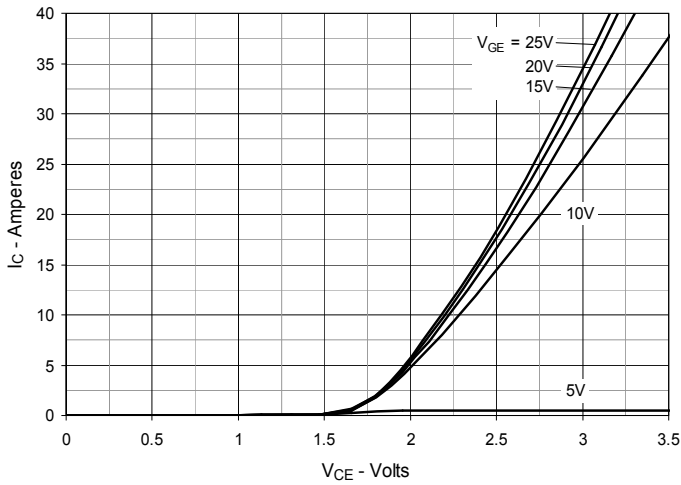

Fig. 2. Extended Output Characteristics @ $T_J = 25^\circ\text{C}$

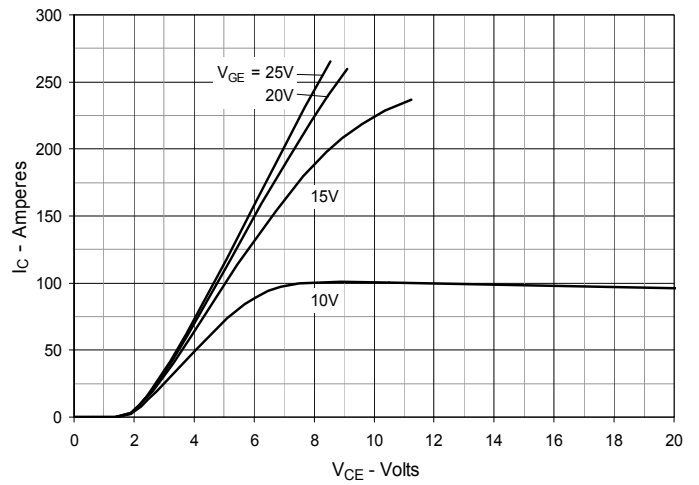

Fig. 3. Output Characteristics @ $T_J = 125^\circ\text{C}$

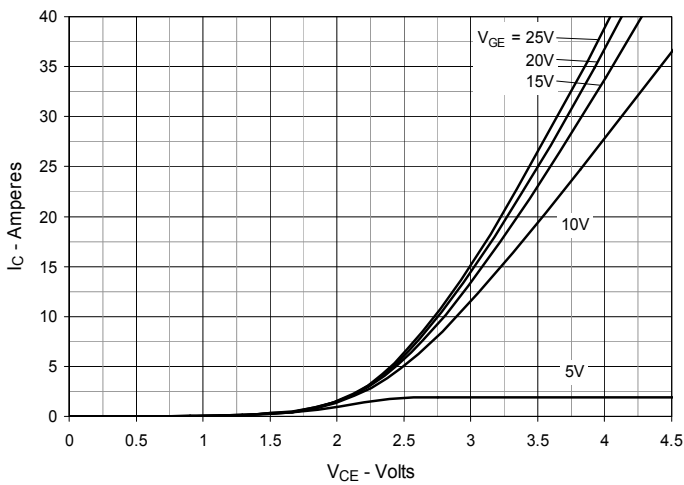

Fig. 4. Dependence of $V_{CE(sat)}$ on Junction Temperature

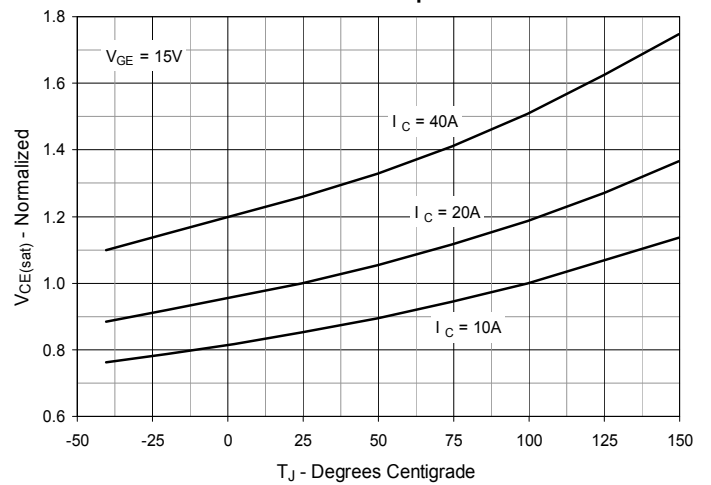

Fig. 5. Collector-to-Emitter Voltage vs. Gate-to-Emitter Voltage

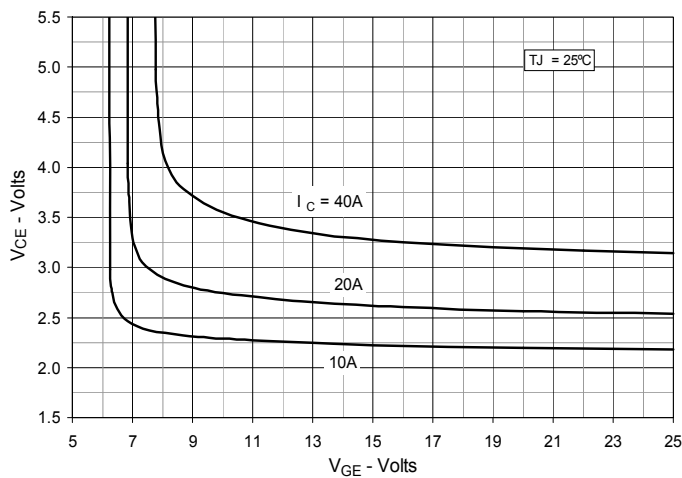

Fig. 6. Input Admittance

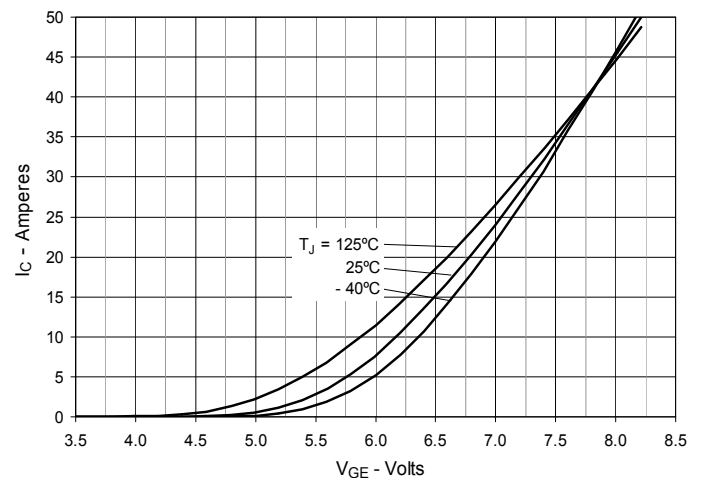

Fig. 7. Transconductance

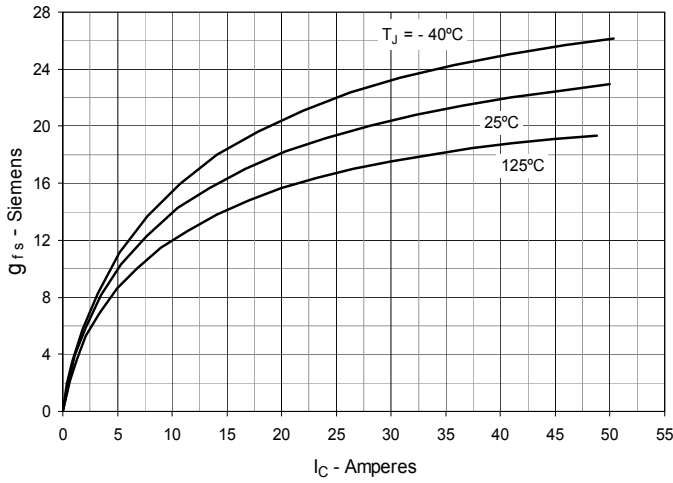

Fig. 8. Forward Voltage Drop of Intrinsic Diode

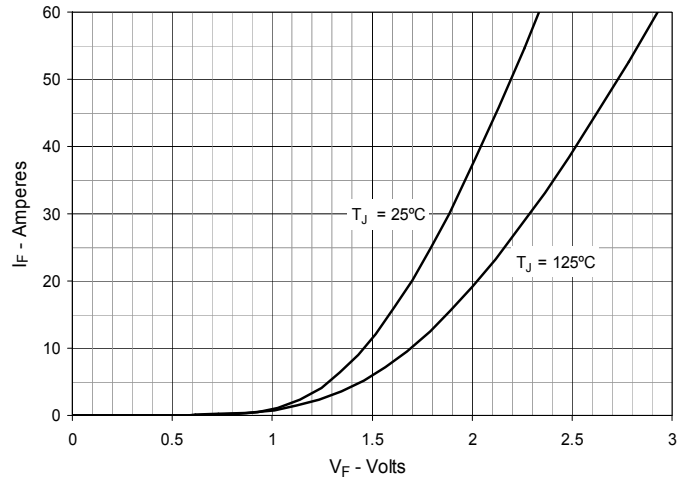

Fig. 9. Gate Charge

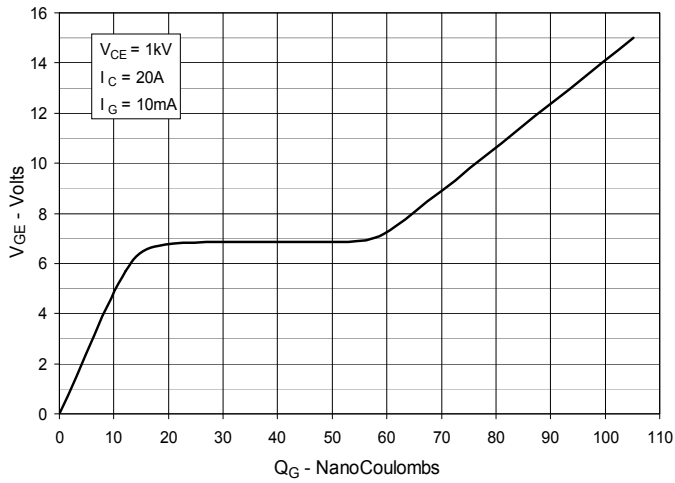

Fig. 10. Capacitance

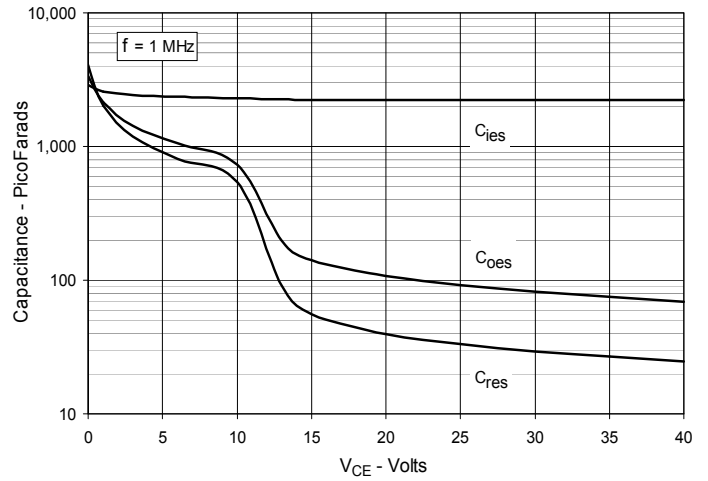

Fig. 11. Reverse-Bias Safe Operating Area

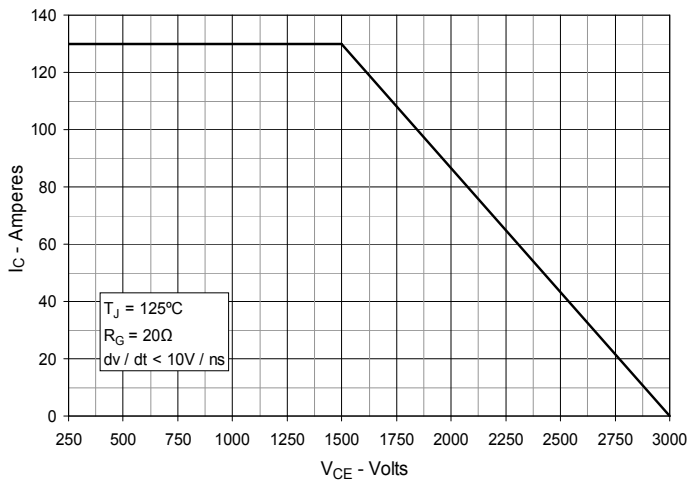

Fig. 12. Maximum Transient Thermal Impedance

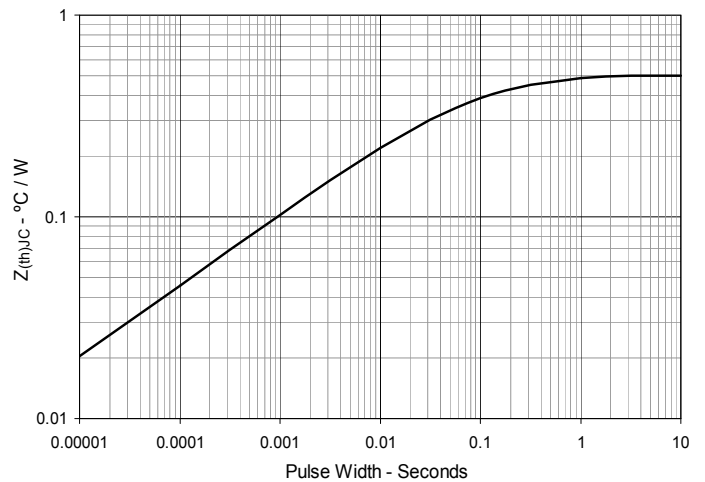

Fig. 13. Resistive Turn-on Rise Time vs. Junction Temperature

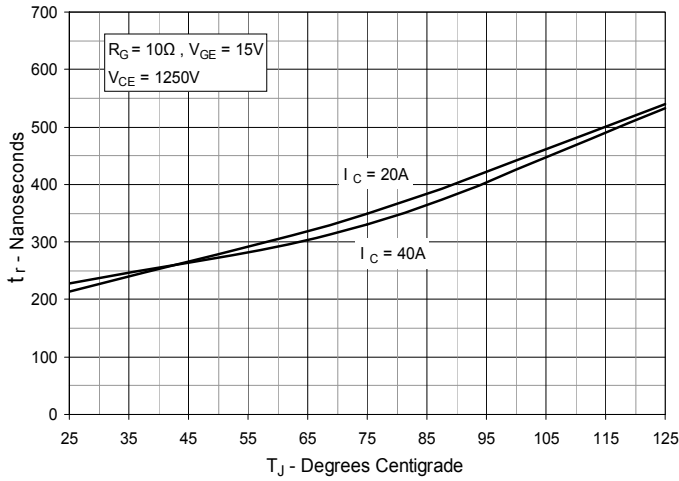

Fig. 14. Resistive Turn-on Rise Time vs. Collector Current

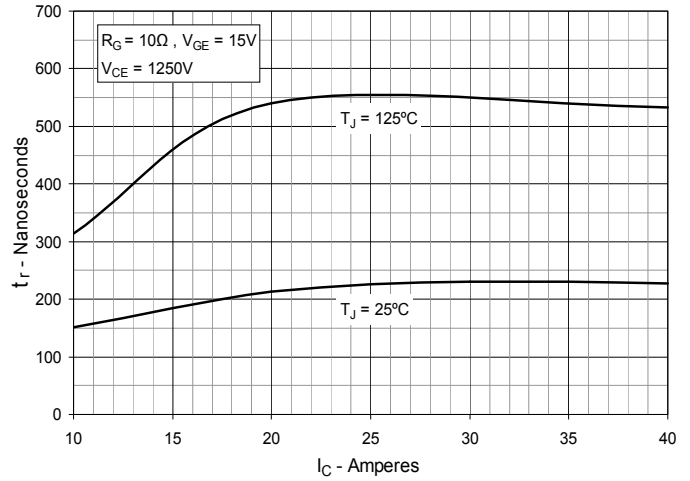

Fig. 15. Resistive Turn-on Switching Times vs. Gate Resistance

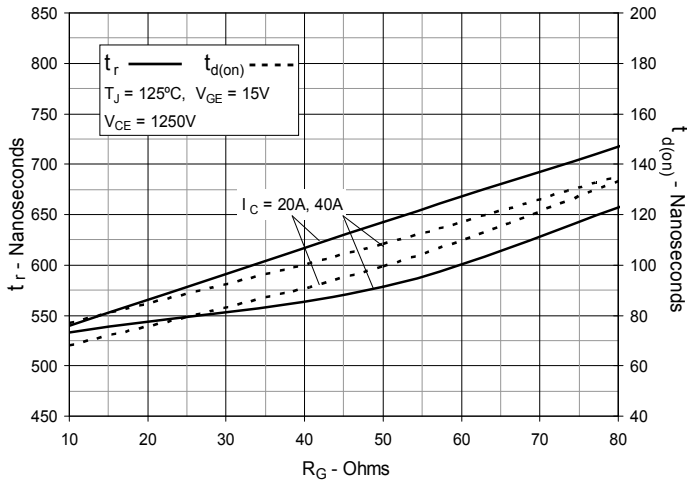

Fig. 16. Resistive Turn-off Switching Times vs. Junction Temperature

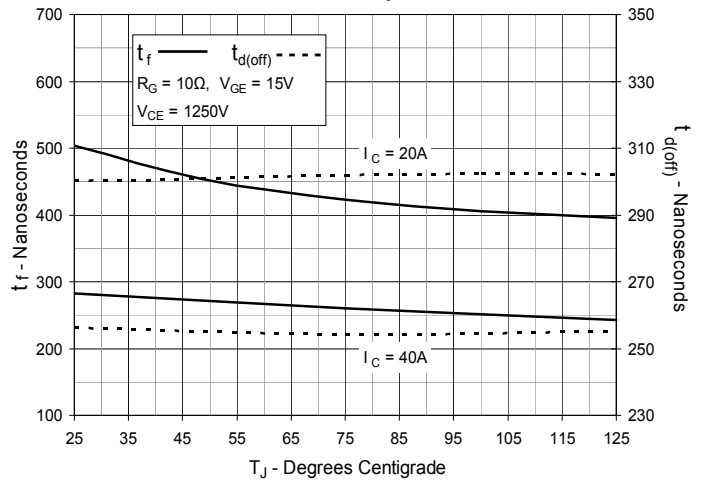

Fig. 17. Resistive Turn-off Switching Times vs. Collector Current

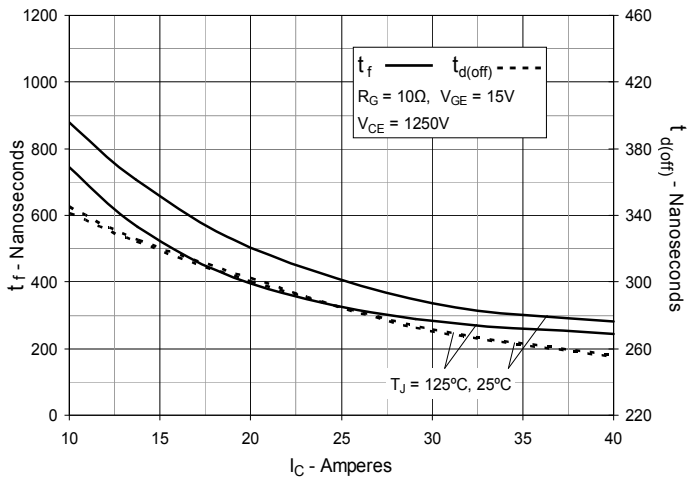

Fig. 18. Resistive Turn-off Switching Times vs. Gate Resistance

