

MAX77714 Evaluation Kit

Evaluates: MAX77714 Multichannel Integrated Power-Management IC

General Description

The MAX77714 evaluation kit (EV kit) is a fully assembled and tested printed circuit board (PCB) that demonstrates the highly-integrated MAX77714 PMIC. The device is a complete power-management IC (PMIC) for mobile devices using System-on-Chip (SOC) applications processors. The device includes four buck regulators, nine low-drop-out linear regulators, eight GPIOs, real-time clock (RTC), backup battery charger, bidirectional reset I/O, interrupt output, and a system watchdog timer.

The EV kit also includes a MAXQ2000 microcontroller command module that provides the I²C interface to control power sequence, individual regulator output on/off, GPIOs, RTC, and setting regulator output voltage.

The MAX77714 evaluation software is provided for easy evaluation.

Benefits and Features

- USB to I²C Converter Allows for Easy Communication
- Level Translator (MAX3395) Allows for Adjusting I²C Bus Voltage from 1.8V to 3.3V
- On-Board Electronics Load Allows for Easy Evaluation
 - GUI Allows Static/Dynamic Load Adjustment for Buck Converters and LDOs
 - MOSFET can be Driven by External Function Generator to Evaluate Transient Performance for Each Regulator
- Proven PCB Reference Design and Layout
- Fully Assembled and Tested

Ordering Information appears at end of data sheet.

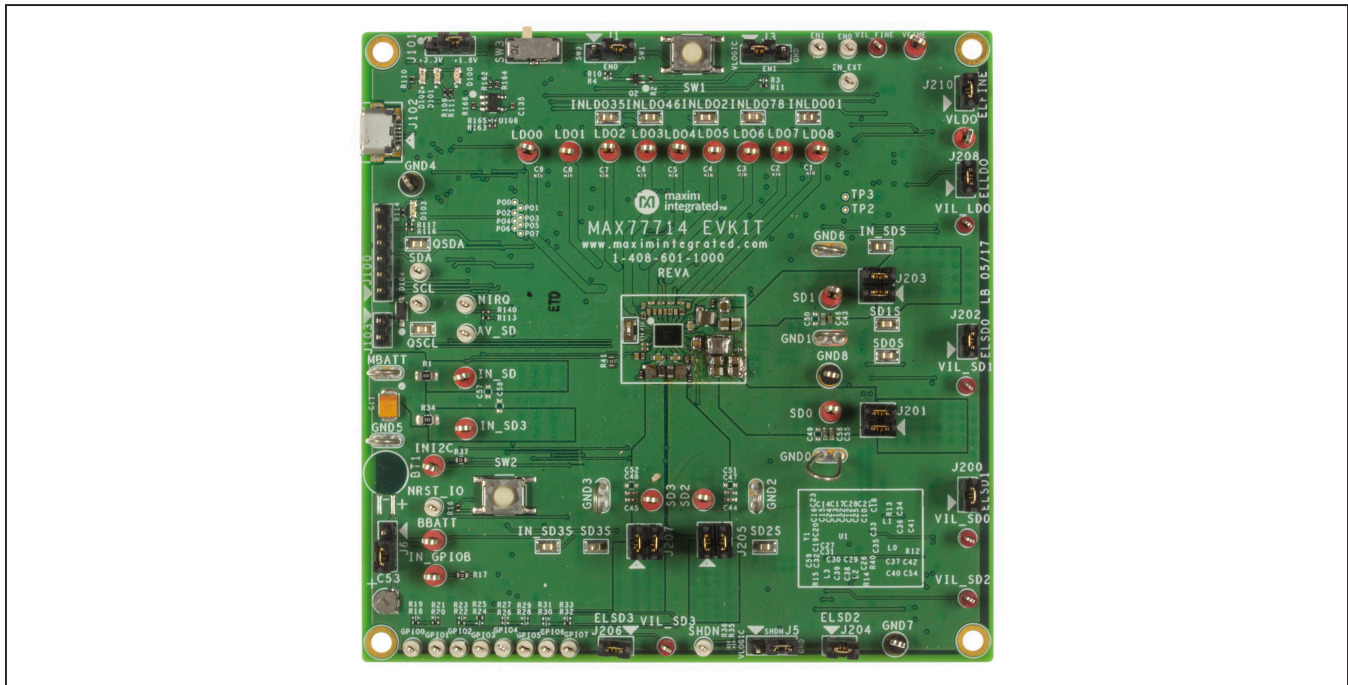

Figure 1. MAX77714 EV Kit Photo

Windows is a registered trademark and registered service mark of Microsoft Corporation.

MAX77714 Evaluation Kit

Evaluates: MAX77714 Multichannel Integrated Power-Management IC

Quick Start

Follow this procedure to familiarize yourself with the EV kit.

Note: In the following sections, software-related items are identified by bolding. Text in **bold** refers to items directly from the EV kit software. Text in **bold and underlined** refers to items from the Windows operating system.

Required Equipment

- MAX77714 EV kit
- Dual power supply with 6V and 5A capability
- Digital voltmeter (DVM)
- Ammeter
- Micro-USB cable

Procedure

The EV kit is fully assembled and tested. Follow the steps below to verify board operation:

- 1) Install GUI software. Visit www.maximintegrated.com/evkitsoftware to download the latest version of the EV kit software. Save the EV kit software to a temporary folder and decompress the ZIP file.
- 2) Install all shunts as recommended in [Table 1](#).
- 3) Connect a disabled 3.6V bench power supply through an ammeter to VIN and GND wire loops. Set the input current limit of the bench supply to 3A. Do not enable the output of the bench supply until prompted.
- 4) Enable the output of the 3.6V bench power supply.
- 5) Connect a Micro-B USB cable between the EV kit and the PC and EV kit.
- 6) Wait a few seconds for the computer to install the USB driver. Once the driver is successfully installed, a Windows pop-up message appears saying that the "USB Serial Converter" is ready to use.
- 7) Open the GUI, and in the upper left corner, select **Device** and then select **Connect** as shown in [Figure 2](#). Once connected, a pop-up window appears as shown in [Figure 3](#). Press the **Read and Close** button.
- 8) Using an external power supply, apply 1.8V to EN0.
- 9) Refer to [Table 2](#) for default voltages and FPS settings.

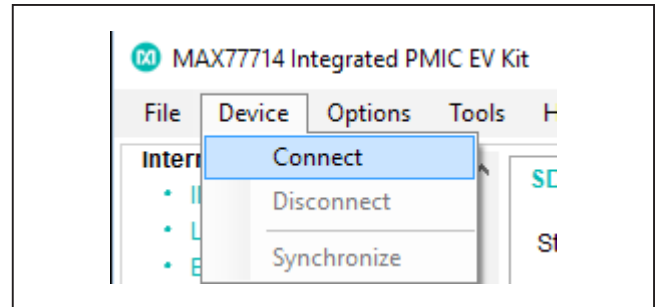

Figure 2: Connecting to the EV Kit

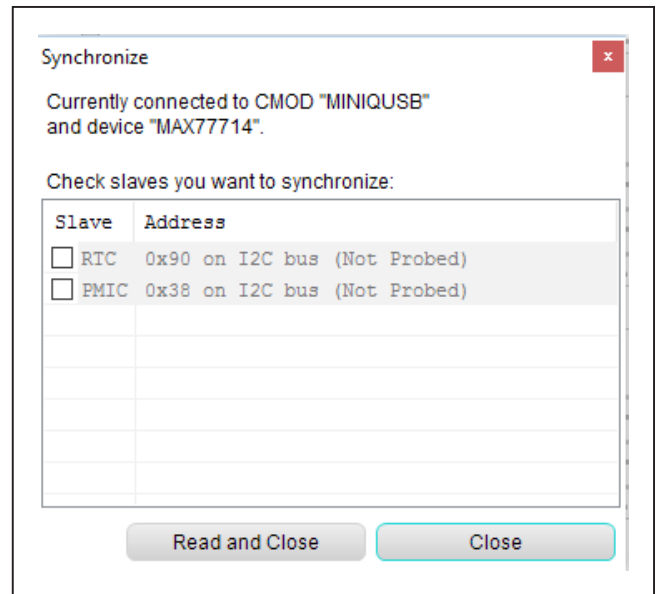

Figure 3: Connecting to the MAX77714

This concludes the initial setup procedure. Users are now encouraged to explore the device and its register settings with the GUI. During this exploration, be mindful of the power supply current limit and input current ammeter's range so as not to interfere with the operation of the device under test.

Using the MAX77714 EV Kit

Table 1. Default Shunt Positions and Jumper Descriptions

REFERENCE DESIGNATOR	DEFAULT POSITION	FUNCTION
J1	Open	EN0 driven by logic signal.
J3	2-3	EN1 = low
J5	2-3	SHDN = low

Table 1. Default Shunt Positions and Jumper Descriptions (continued)

REFERENCE DESIGNATOR	DEFAULT POSITION	FUNCTION
J6	2-3	Connect BBATT to supercapacitor.
J200	1-2	Connects amplifier to the gate of the load FET for SD0.
J201	1-2, 2-3	Connects SD1 to load FET.
J202	1-2	Connects amplifier to the gate of the load FET for SD1.
J203	1-2, 3-4	Connects SD1 to load FET.
J204	1-2	Connects amplifier to the gate of the load FET for SD2.
J205	1-2, 3-4	Connects SD2 to load FET.
J206	1-2	Connects amplifier to the gate of the load FET for SD3.
J207	1-2, 3-4	Connects SD3 to load FET.
J208	1-2	Connects amplifier to the gate of the load FET for LDO.
J210	1-2	Connects amplifier to the gate of the load FET for FINE load.
JU101	2-3	Sets VLOGIC to 1.8V.

Table 2. Default FPS Setting

OUTPUT	EXPECTED VOLTAGE (OPTION1)	FPS SETTING	
		POWER UP (SLOT)	POWER DOWN (SLOT)
SD0	0.9	1	1
SD1	1.25	3	3
SD2	1.825	5	5
SD3	0.9	2	2
LDO0	1.8	6	6
LDO1	0.9	6	6
LDO2	3.3	6	6
LDO3	3.0	6	6
LDO4	0.9	6	6
LDO5	3.3	6	6
LDO6	1.8	4	4
LDO7	3.3	6	6
LDO8	2.9	7	7
GPIO0	N/A	0	0
GPIO1	N/A	N/A	N/A
GPIO2	N/A	N/A	N/A
GPIO3	N/A	N/A	N/A
GPIO4	N/A	N/A	N/A
GPIO5	N/A	N/A	N/A
GPIO6	N/A	N/A	N/A
GPIO7	N/A	N/A	N/A

MAX77714 Evaluation Kit

Evaluates: MAX77714 Multichannel
Integrated Power-Management IC

Ordering Information

PART	TYPE
MAX77714EVKIT#	EVKIT

#Denotes RoHS compliant.

MAX77714 Evaluation Kit

Evaluates: MAX77714 Multichannel Integrated Power-Management IC

MAX77714 EV Kit Bill of Materials

REF_DES	DNI/DNP	QTY	MFG PART #	MANUFACTURER	VALUE	DESCRIPTION
AV_SD, VIL_LDO, VIL_SDO-VIL_SD3, VIL_FINE		7	5000	KEystone	N/A	TEST POINT; PIN DIA=0.1IN; TOTAL LENGTH=0.3IN; BOARD HOLE=0.04IN; RED; PHOSPHOR BRONZE WIRE SILVER PLATE FINISH;
SD0-SD3, LDO0-LDO8, VLDO, BBATT, INI2C, IN_SD, VFINE, IN_SD3, IN_GPIOB		20	5010	KEystone	N/A	TESTPOINT WITH 1.80MM HOLE DIA, RED, MULTIPURPOSE;
C10, C16		2	C1005X750J225K050BC; GRM155C70J225KE11	TDK/MURATA	2.2UF	CAPACITOR; SMT (0402); CERAMIC CHIP; 2.2UF; 6.3V; TOL=10%; MODEL=C SERIES; TG=-55 DEGC TO +125 DEGC; TC=X7S
C11		1	TCJB107M006R0070	AVX	100UF	CAPACITOR; SMT (3528); TANTALUM CHIP; 100UF; 6.3V; TOL=20%; MODEL=TCJ SERIES
C13-C15, C17, C18, C21-C25, C28		11	ANY	ANY	1UF	CAPACITOR; SMT (0402); CERAMIC CHIP; 1UF; 10V; TOL=10%; MODEL=; TG=-55 DEGC TO +85 DEGC; TC=X5R;
C26, C27, C31, C32		4	GRM152C80J104KE19	MURATA	0.1UF	CAPACITOR; SMT (0402); CERAMIC CHIP; 0.1UF; 6.3V; TOL=10%; TG=-55 DEGC TO +105 DEGC; TC=X6S
C29, C30, C33		3	GRM188R60J106KE47	MURATA	10UF	CAPACITOR; SMT (0603); CERAMIC CHIP; 10UF; 6.3V; TOL=10%; MODEL=; TG=-55 DEGC TO +85 DEGC; TC=X5R
C34, C36, C37, C40-C42, C54		7	JMK212BJ226KG	TAIYO YUDEN	22UF	CAPACITOR; SMT (0805); CERAMIC CHIP; 22UF; 6.3V; TOL=10%; MODEL=M SERIES; TG=-55 DEGC TO +85 DEGC; TC=X5R
C35		1	GRM21BR70J106K; C2012X7R0J106K125AB	MURATA/TKD	10UF	CAPACITOR; SMT (0805); CERAMIC CHIP; 10UF; 6.3V; TOL=10%; MODEL=GRM SERIES; TG=-55 DEGC TO +125 DEGC; TC=X7R
C38, C39		2	C1608X5R0J226M080AC	TDK	22UF	CAPACITOR; SMT (0603); CERAMIC CHIP; 22UF; 6.3V; TOL=20%; MODEL=C SERIES; TG=-55 DEGC TO +85 DEGC; TC=X5R
C43-C45, C55		4	GRM155R61A103KA01	MURATA	0.01UF	CAPACITOR; SMT (0402); CERAMIC CHIP; 0.01UF; 10V; TOL=10%; MODEL=GRM SERIES; TG=-55 DEGC TO +85 DEGC; TC=X5R
C46-C48, C56		4	GRM155R60J104KA01; C0402C104K9PAC	MURATA; KEMET	0.1UF	CAPACITOR; SMT (0402); CERAMIC CHIP; 0.1UF; 6.3V; TOL=10%; TG=-55 DEGC TO +85 DEGC; TC=X5R
C53		1	XH311HU IV07E	SEIKO INSTRUMENTS INC	0.035F	CAPACITOR; SMT; ELECTRIC DOUBLE LAYER CAPACITOR; 0.035F; 3.3V; TOL=20%; TG=-20 DEGC TO +60 DEGC; TC=NO DATA;
C59		1	GRM155R61A106ME44; GRM155R61A106ME11; 0402ZD106MAT2A	MURATA; AVX	10UF	CAPACITOR; SMT (0402); CERAMIC CHIP; 10UF; 10V; TOL=20%; TG=-55 DEGC TO +85 DEGC; TC=X5R
C108, C135, C150, C151, C155-C157, C159		8	ANY	ANY	0.1UF	CAPACITOR; SMT (0402); CERAMIC CHIP; 0.1UF; 50V; TOL=10%; MODEL=CGA SERIES; TG=-55 DEGC TO +125 DEGC; TC=X7R; FORMFACTOR
C110-C113, C115, C118, C120, C158, C248-C250		11	ANY	ANY	1UF	CAPACITOR; SMT (0402); CERAMIC CHIP; 1UF; 6.3V; TOL=10%; MODEL=; TG=-55 DEGC TO +85 DEGC; TC=X5R;
C114		1	ANY	ANY	0.47UF	CAPACITOR; SMT; 0603; CERAMIC; 0.47UF; 10V; 10%; X5R; -55degC to + 125degC; ; FORMFACTOR
C152, C153		2	C0402C0G500-150JNP; GRM1555C1H150JA01	VENKEL LTD./MURATA	15PF	CAPACITOR; SMT (0402); CERAMIC CHIP; 15PF; 50V; TOL=5%; TG=-55 DEGC TO +125 DEGC; TC=C0G
C12, C154		2	ANY	ANY	4.7UF	CAPACITOR;SMT(0402);CERAMICCHIP;4.7UF;10V;TOL=20%;MODEL=C SERIES;TG=-
C200, C207, C214, C221, C238, C255		6	GRM155R71E472KA01	MURATA	4700PF	CAPACITOR; SMT (0402); CERAMIC CHIP; 4700PF; 25V; TOL=10%; TG=-55 DEGC TO +125 DEGC; TC=X7R;
C201, C208, C215, C222, C239, C257		6	ANY	ANY	1000PF	CAPACITOR; SMT (0402); CERAMIC CHIP; 1000PF; 50V; TOL=10%; MODEL=C0G; TG=-55 DEGC TO +125 DEGC; TC=+; FORMFACTOR
C202, C210, C217, C224, C228-C230, C241, C245-C247, C256		12	ANY	ANY	0.1UF	CAPACITOR; SMT (0402); CERAMIC CHIP; 0.1UF; 25V; TOL=10%; MODEL=C SERIES; TG=-55 DEGC TO +125 DEGC; TC=X7R; FORMFACTOR
C204, C205, C211, C212, C218, C219, C242, C243		8	ECJ-0EB1H101K; CC0402KRX7R9BB101	PANASONIC; YAGEO PHYCOMP	100PF	CAPACITOR; SMT (0402); CERAMIC CHIP; 100PF; 50V; TOL=10%; MODEL=ECJ SERIES; TG=-55 DEGC TO +125 DEGC; TC=X7R
C206, C213, C220, C227, C244, C260		6	ANY	ANY	1UF	CAPACITOR; SMT (0402); CERAMIC CHIP; 1UF; 6.3V; TOL=20%; MODEL=C SERIES; TG=-55 DEGC TO +85 DEGC; TC=X5R; ; FORMFACTOR
C225, C226, C258, C259		4	C0402C680J5GAC;GRM1555C1H680J A01	KEMET/MURATA	68PF	CAPACITOR; SMT; 0402; CERAMIC; 68pF; 50V; 5%; C0G; -55degC to + 125degC; 0 +/-30PPM/degC
D100, D101		2	LTST-C190YKT	LITE-ON ELECTRONICS; INC.	LTST-C190YKT	DIODE; LED; STANDARD; YELLOW; SMT (0603); PIV=5.0V; IF=0.02A; -55 DEGC TO +85 DEGC
D102, D103		2	LTST-C190CKT	LITE-ON ELECTRONICS; INC.	LTST-C190CKT	DIODE; LED; STANDARD; RED; SMT (0603); PIV=5.0V; IF=0.04A; -55 DEGC TO +85 DEGC
D104		1	CMHSH5-4	CENTRAL SEMICONDUCTOR CORP.	CMHSH5-4	DIODE; SCH; SMT (SOD-123); PIV=40V; IF=0.5A; -65 DEGC TO +125 DEGC
ENO, EN1, SCL, SDA, NIRQ, SHDN, GPIO0-GPIO7, EN_EXT, NRST_IO		16	5002	KEystone	N/A	TEST POINT; PIN DIA=0.1IN; TOTAL LENGTH=0.3IN; BOARD HOLE=0.04IN; WHITE; PHOSPHOR BRONZE WIRE
FB100		1	BLM18PG221SN1	MURATA	220	INDUCTOR; SMT (0603); FERRITE-BEAD; 220; TOL=+/-25%; 1.4A; -55 DEGC TO +125 DEGC
GND0-GND3, GND5, GND6, MBATT		7	9020 BUSS	WEICO WIRE	MAXIMPAD	EVK KIT PARTS; MAXIM PAD; WIRE; NATURAL; SOLID; WEICO WIRE; SOFT DRAWN BUS TYPE-S; 20AWG

MAX77714 Evaluation Kit

Evaluates: MAX77714 Multichannel Integrated Power-Management IC

MAX77714 EV Kit Bill of Materials (continued)

REF_DES	DNI/DNP	QTY	MFG PART #	MANUFACTURER	VALUE	DESCRIPTION
GND4, GND7, GND8		3	5011	KEystone	N/A	TEST POINT; PIN DIA=0.125IN; TOTAL LENGTH=0.445IN; BOARD HOLE=0.063IN; BLACK; PHOSPHOR BRONZE WIRE SILVER PLATE FINISH;
QSCL, QSDA, SD05-SD35, INLDO01, INLDO2, IN_SDS, INLDO35, INLDO46, INLDO78,		13	USE FOR COLD TEST: 5015	KEystone	N/A	TEST POINT; SMT; PIN LENGTH=0.135IN; PIN WIDTH=0.07IN; PIN HEIGHT=0.06IN; SILVER; PHOSPHOR BRONZE WITH SILVER PLATE CONTACT
J1, J3, J5, J6		4	TSW-103-07-L-S	SAMTEC	TSW-103-07-L-S	CONNECTOR; THROUGH HOLE; SINGLE ROW; STRAIGHT; 3PINS
J100		1	PBC06SAAN	SULLINS ELECTRONICS CORP.	PBC06SAA N	CONNECTOR; MALE; THROUGH HOLE; BREAKAWAY; STRAIGHT; 6PINS; -65 DEGC TO +125 DEGC
J101		1	PBC03SABN	SULLINS	PBC03SAB N	CONNECTOR; MALE; THROUGH HOLE; BREAKAWAY; STRAIGHT; 3PINS
J102		1	10103592-0001LF	FCI CONNECT	10103592-0001LF	CONNECTOR; FEMALE; SMT; MICRO USB B-TYPE REVERSE; RIGHT ANGLE; 5PINS
J103, J200, J202, J204, J206, J208, J210		7	TSW-102-07-T-S	SAMTEC	TSW-102-07-T-S	CONNECTOR; THROUGH HOLE; TSW SERIES; SINGLE ROW; STRAIGHT; 2PINS; -55 DEGC TO +105 DEGC
J201, J203, J205, J207		4	PBC02DABN	SULLINS ELECTRONIC CORP.	PBC02DAB N	CONNECTOR; MALE; THROUGH HOLE; BREAKAWAY; STRAIGHT; 4PINS
L0		1	DFE322520F-1R0M	MURATA	1UH	INDUCTOR; SMT (2010); METAL ALLOY CHIP; 1UH; TOL=+/-20%; 6.3A
L1		1	CIGT252010EH1R0M	SAMSUNG ELECTRONICS	1UH	INDUCTOR; SMT (1008); MAGNETICALLY SHIELDED; 1UH; TOL=+/-20%; 4.3A
L2, L3		2	PIFE20161T-1R0MDR	CYNTEC	1UH	INDUCTOR; SMT; FERRITE BOBBIN CORE; 1UH; TOL=+/-20%; 2.8A; -55 DEGC TO +125 DEGC; FORMFACTOR
Q2, Q100, Q101		3	FDY300NZ	FAIRCHILD SEMICONDUCTOR	FDY300NZ	TRAN; SINGLE N-CHANNEL 2.5V SPECIFIED POWER TRENCH MOSFET; NCH; SC89; PD-(0.625W); I-(57A); V-(25V)
Q200-Q203		4	IRLR8259TRPBF	INTERNATIONAL RECTIFIER	IRLR8259TRPBF	TRAN; HEXFET POWER MOSFET; NCH; DPAK; PD-(48W); I-(57A); V-(25V)
Q205		1	DMG3420U	DIODES INCORPORATED	DMG3420U	TRAN; N-CHANNEL ENHANCEMENT MODE MOSFET; NCH; SOT-23; PD-(0.74W); I-(5.47A); V-(20V)
Q206		1	IRFHM8337TRPBF	INTERNATIONAL RECTIFIER	IRFHM8337TRPBF	TRAN; HEXFET POWER MOSFET; NCH; PQFN8; PD-(2.8W); I-(18A); V-(30V)
Q300-Q308		9	SIA914ADJ-T1-GE3	VISHAY SILICONIX	SIA914ADJ-T1-GE3	TRAN; DUAL N-CHANNEL 20 V (D-S) MOSFET; NCH; SC70-6; PD-(7.8W); I-(4.5A); V-(20V)
R1, R34		2	CRCW0805000020EAHP	VISHAY DRALORIC	0	RESISTOR; 0805; 0 OHM; 0%; JUMPER; 0.5W; THICK FILM
R5-R9, R17, R37, R41, R142		9	CRCW0603000020	VISHAY DALE	0	RESISTOR; 0603; 0 OHM; 0%; JUMPER; 0.1W; THICK FILM
R12-R15, R38-R40, R42, R116, R135, R136, R139-R141, R143, R148, R155, R162-R164, R166, R203, R213, R223, R233, R252, R260, R261, R265, R267, R290		31	ERJ-2GE0R00X	PANASONIC	0	RESISTOR; 0402; 0 OHM; 0%; JUMPER; 0.10W; THICK FILM
R2, R10, R11, R16, R113, R18, R20, R22, R25, R32, R115, R157, R159, R161, R262, R263, R266, R268		18	ANY	ANY	100K	RESISTOR; 0402; 100K; 1%; 100PPM; 0.0625W; THICK FILM; FORMFACTOR
R100, R118		2	ANY	ANY	4.7K	RESISTOR; 0402; 4.7K OHM; 1%; 100PPM; 0.0625W; THICK FILM; FORMFACTOR
R103, R123		2	ANY	ANY	22	RESISTOR; 0402; 22 OHM; 1%; 100PPM; 0.0625W; THICK FILM; FORMFACTOR
R107, R108		2	ANY	ANY	2.2K	RESISTOR; 0402; 2.2K OHM; 1%; 100PPM; 0.0625W; THICK FILM; FORMFACTOR
R110, R117		2	CRCW0402470RFK	VISHAY DALE	470	RESISTOR; 0402; 470 OHM; 1%; 100PPM; 0.0625W; THICK FILM
R114, R318-R336		20	CRCW040210K0FK; RC0402FR-0710K	VISHAY DALE; YAGEO PHICOMP	10K	RESISTOR; 0402; 10K; 1%; 100PPM; 0.0625W; THICK FILM
R122		1	ANY	ANY	1M	RESISTOR; 0603; 1M; 1%; 100PPM; 0.10W; THICK FILM; FORMFACTOR
R137, R138		2	ANY	ANY	49.9	RESISTOR; 0402; 49.9 OHM; 1%; 100PPM; 0.0625W; THICK FILM; FORMFACTOR
R156		1	CRCW0402105KFK	VISHAY DALE	105K	RESISTOR; 0402; 105K OHM; 1%; 100PPM; 0.063W ;
R158		1	CRCW0402169KFK	VISHAY DALE	169K	RESISTOR; 0402; 169K OHM; 1%; 100PPM; 0.063W ;
R160		1	CRCW04024752FK; 9C04021A4752FLHF3;	VISHAY DALE	47.5K	RESISTOR; 0402; 47.5K; 1%; 100PPM; 0.0625W; THICK FILM
R200, R210, R214, R215, R220, R230, R250, R270		8	CRCW040220K0FK	VISHAY DALE	20K	RESISTOR; 0402; 20K OHM; 1%; 100PPM; 0.063W; THICK FILM
R109, R111, R201, R211, R221, R231, R251, R271		8	CRCW0402100RFK; 9C04021A1000FL; RC0402FR-	VISHAY DALE; PANASONIC; YAGEO PHYCOMP	100	RESISTOR; 0402; 100 OHM; 1%; 100PPM; 0.063W; THICK FILM
R202, R212, R222, R232, R253, R272		6	CRCW0402680RFK; RC0402FR-07680RL	VISHAY DALE/YAGEO PHICOMP	680	RESISTOR; 0402; 680 OHM; 1%; 100PPM; 0.0625W; THICK FILM
R204, R205		2	CR0402-16W-1622FT;	VENKEL LTD./VISHAY DALE	16.2K	RESISTOR; 0402; 16.2K OHM; 1%; 100PPM; 0.063W;
R206, R216, R226, R236, R256		6	CRCW04021M00FK	VISHAY DALE	1M	RESISTOR; 0402; 1M; 1%; 100PPM; 0.0625W; THICK FILM
R207, R208, R217, R218, R227, R228, R237, R238, R257, R258, R292, R295		12	ANY	ANY	1K	RESISTOR; 0402; 1K; 1%; 100PPM; 0.0625W; THICK FILM; FORMFACTOR
R209, R219		2	WSL2512R0200F	N/A	0.02	RESISTOR; 2512; 0.02 OHM; 1%; 75PPM; 1.0W; THICK
R224, R225, R234, R235		4	CRCW04024K75FK	VISHAY DALE	4.75K	RESISTOR; 0402; 4.75K; 1%; 100PPM; 0.0625W; THICK
R229, R239		2	CRA2512-FZ-R100ELF	BOURNS	0.1	RESISTOR; 2512; 0.1 OHM; 1%; 75PPM; 3W; METAL FILM
R254, R255		2	CRCW040276K8FK	VISHAY DALE	76.8K	RESISTOR; 0402; 76.8K OHM; 1%; 100PPM; 0.063W;
R259, R280		2	CSR1206FT1R00	STACKPOLE ELECTRONICS INC.	1	RESISTOR; 1206; 1 OHM; 1%; 100PPM; 0.5W; THICK FILM

MAX77714 Evaluation Kit

Evaluates: MAX77714 Multichannel Integrated Power-Management IC

MAX77714 EV Kit Bill of Materials (continued)

REF_DES	DNI/DNP	QTY	MFG PART #	MANUFACTURER	VALUE	DESCRIPTION
R264, R276, R278, R282, R286, R274, R296		6	CRCW0402649KFK	VISHAY DALE	649K	RESISTOR; 0402; 649K OHM; 1%; 100PPM; 0.063W;
R275, R277, R279, R281, R285, R294		2	CRO402-16W-3161FT;	VENKEL LTD./VISHAY DALE	3.16K	RESISTOR; 0402; 3.16K OHM; 1%; 100PPM; 0.063W;
R300, R302		6	ERJ-2RKF4703X	PANASONIC	470K	RESISTOR, 0402, 470K OHM, 1%, 100PPM, 0.0625W, THICK FILM
R301, R303		2	CRCW251220R0JN	VISHAY DALE	20	RESISTOR; 2512, 20OHMS, 5%, 200PPM, 1.0W, THICK
R304, R310, R312		2	CRCW060378R7FK	VISHAY DALE	78.7	RESISTOR; 0603; 78.7 OHM; 1%; 100PPM; 0.10W; THICK
R305, R311, R313		3	RMCP2010FT33R0	STACKPOLE ELECTRONICS INC	33	RESISTOR; 2010; 33 OHM; 1%; 100PPM; 1W; THICK FILM
R306		3	CRCW0603133RFK	VISHAY DALE	133	RESISTOR; 0603; 133 OHM; 1%; 100PPM; 0.10W; THICK
R307		1	CRCW251216R0FKEGHP	VISHAY DRALORIC	16	RESISTOR; 2512; 16 OHM; 1%; 100PPM; 1.5W; THICK
R308		1	TNPW060366R5BE	VISHAY DALE	66.5	RESISTOR; 0603; 66.5 OHM; 0.1%; 25PPM; 0.10W; THIN
R309		1	CRCW121010R0FK	VISHAY DALE	10	RESISTOR; 1210; 10 OHM; 1%; 100PPM; 0.5W; THICK
R314		1	CRCW060342R2FK	VISHAY DALE	42.2	RESISTOR; 0603; 42.2 OHM; 1%; 100PPM; 0.10W; THICK
R315		1	SR733ATTE6R04F	KOA SPEER ELECTRONICS INC.	6.04	RESISTOR; 1210; 6.04 OHM; 1%; 100PPM; 1.0W; THICK
R316		1	CRCW060326R1FK;	VISHAY DALE	26.1	RESISTOR; 0603; 26.1 OHM; 1%; 100PPM; 0.10W; THICK
R317		1	CRCW25128R06FN	VISHAY DALE	8.06	RESISTOR; 2512; 8.06 OHM; 1%; 200PPM; 1.0W; THICK
R317		1	CRCW060339R0FK	VISHAY DALE	39	RESISTOR, 0603, 39 OHM, 1%, 100PPM, 0.10W, THICK
SW-EN0, SW-NRSTIO		2	EVQ-Q2K03W	PANASONIC	EVQ-Q2K03W	SWITCH; SPST; SMT; 15V; 0.02A; LIGHT TOUCH SWITCH; RCOIL= OHM; RINSULATION= OHM; PANASONIC
SW3		1	CL-SB-12A-11	NIDEC COPAL ELECTRONICS CORP	CL-SB-12A-11	SWITCH; SPDT; SMT; STRAIGHT; 12V; 0.2A; CL-SB SERIES; RCOIL=0.05 OHM; RINSULATION=100M OHM
U1		1	MAX77714EWC+	MAXIM	MAX77714 EWC+	EVKIT PART-IC; PACKAGE OUTLINE 21-100187; PACKAGE CODE W703A4+1
U100		1	MAXQ2000-RBX+	MAXIM	MAXQ2000-RBX+	IC; CTRL; LOW-POWER LCD MICROCONTROLLER; TQFN56 EP 8X8
U101		1	FT232RQ	FUTURE TECHNOLOGY DEVICES INTL LTD.	FT232RQ	IC; INFC; UART INTERFACE IC USB TO SERIAL; QFN32-EP 5X5
U102-U104		3	MAX8512EXK+	MAXIM	MAX8512EXK	IC; VREG, Ultra-Low-Noise, High PSRR, Adjustable Vout, SC70-5
U107		1	MAX3395ETC+	MAXIM	MAX3395ETC	IC; TRANS; 15KV ESD-PROTECTED HIGH-DRIVE CURRENT QUAD-LEVEL TRANSLATOR WITH SPEED-UP CIRCUITRY;
U108		1	24AA02T-I/OT	MICROCHIP	24AA02T-I/OT	IC; EPROM; 2K I2C SERIAL EEPROM; SOT23-5
U200-U203, U205, U209		6	MAX44251AUA+	MAXIM	MAX44251AUA+	IC; OPAMP; ULTRA-PRECISION; LOW-NOISE OP AMP; UMAX8
U206, U207		2	MAX5815AAUD+	MAXIM	MAX5815AAUD+	IC; DAC; ULTRA-SMALL; QUAD-CHANNEL; 12-BIT BUFFERED OUTPUT DAC WITH INTERNAL REFERENCE AND I2C INTERFACE; TSSOP14
U208		1	SX1503I091TRT	SEMTECH	SX1503I091TRT	IC; XPND; 16 CHANNEL LOW VOLTAGE GPIO; QFN28-EP
U210		1	SX1502I087TRT	SEMTECH	SX1502I087TRT	IC; XPND; 8-CHANNEL LOW VOLTAGE GPIO EXPANDER; UTQFN20-EP 3X3
Y1		1	CC7V-T1A 32.768KHZ 9.0PF;FC-135 32.7680KA-A3	EPSON;MICRO CRYSTAL	32.768KHZ	CRYSTAL; SMT (1206) 3.2MM x 1.5MM; 12.5PF; 32.768KHZ; +/-20PPM; +/-50PPM; -40 DEGC TO +85
Y101		1	CX3225SB16000D0FLJZZ	KYOCERA-KINSEKI	16MHZ	CRYSTAL; SMT (3225) 3.2X2.5; 8PF; 16MHZ; +/-10PPM; +/-15PPM
PCB		1	MAXMD14_SOLDERDOWN	MAXIM	PCB	PCB:MAXMD14_SOLDERDOWN
BT1	DNP	0	ML614S/F9F	PANASONIC	ML614S/F9F	BATTERY; SMT; DIA=6.8MM; HT=1.45MM; 3V; 0.01A; LITHIUM;
C1-C9, C19, C20, C129, C134	DNP	0	N/A	N/A	OPEN	CAPACITOR; SMT (0402); OPEN; FORMFACTOR
C49-C52, C57, C58	DNP	0	N/A	N/A	OPEN	CAPACITOR; SMT (0603); OPEN; FORMFACTOR
R3, R4, R19, R21, R23, R24, R26-R31, R33, R35, R36, R165	DNP	0	N/A	N/A	OPEN	RESISTOR; 0402; OPEN; FORMFACTOR

NOTE: DNI-DO NOT INSTALL (PACKOUT); DNP-DO NOT PROCURE

MAX77714 EV Kit Schematics

Part Number	Pin Strap	7-bit		8-bit Write		8-bit Read	
MAX77714 PMIC	OTP_I2C_ADDR[1:0]=0b00	RTC	0x48 0b100 1000	RTC	0x90 0b1001 0000	RTC	0x91 0b1001 0001
		PMIC/GPIO	0x1C 0b001 1100	PMIC/GPIO	0x38 0b0011 1000	PMIC/GPIO	0x39 0b0011 1001
MAX77714 PMIC	OTP_I2C_ADDR[1:0]=0b01	RTC	0x4A 0b100 1010	RTC	0x94 0b1001 0100	RTC	0x95 0b1001 0101
		PMIC/GPIO	0x1C 0b001 1100	PMIC/GPIO	0x3C 0b0011 1100	PMIC/GPIO	0x3D 0b0011 1101
MAX77714 PMIC	OTP_I2C_ADDR[1:0]=0b10	RTC	0x68 0b110 1000	RTC	0xD0 0b1101 0000	RTC	0xD1 0b1101 0001
		PMIC/GPIO	0x3C 0b011 1100	PMIC/GPIO	0x78 0b0111 1000	PMIC/GPIO	0x79 0b0111 1001
MAX77714 PMIC	OTP_I2C_ADDR[1:0]=0b11	RTC	0x6A 0b110 1010	RTC	0xD4 0b1101 0100	RTC	0xD5 0b1101 0101
		PMIC/GPIO	0x3E 0b011 1110	PMIC/GPIO	0x7C 0b0111 1100	PMIC/GPIO	0x7D 0b0111 1101
MAX5815 * (DAC) U207	ADDR1=ADDR0=VDD	0x10 0b001 0000		0x20 0b0010 0000		0x21 0b0010 0001	
MAX5815 * (DAC) U206	ADDR1=ADDR0=GND	0x1F 0b001 1111		0x3E 0b0011 1110		0x3F 0b0011 1111	
SX1503 U208 GPIO EXPANDER	N/A	0x20 0b010 0000		0x40 0b0100 0000		0x41 0b0100 0001	
SX1502 U210 GPIO EXPANDER	ADDR=3.3V	0x21 0b010 0001		0x42 0b0100 0010		0x43 0b0100 0011	
24AA02	N/A	0x50 to 0x57 0b1010xxx		0b1010xxx0		0b1010xxx1	

* MAX5815 also responds to an I2C broadcast address 0b0001000

MAX77714 EV Kit Schematics (continued)

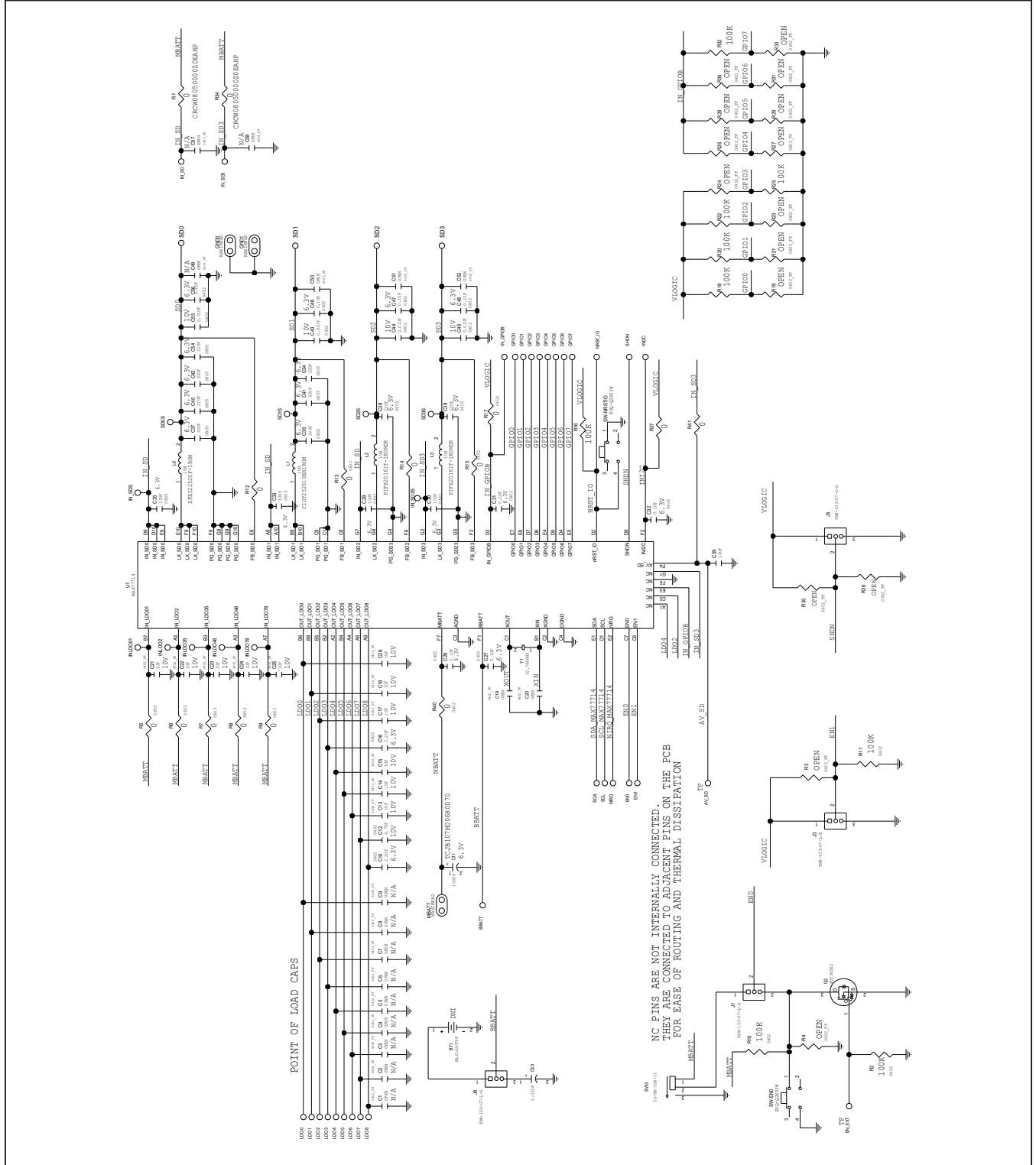

MAX77714 EV Kit Schematics (continued)

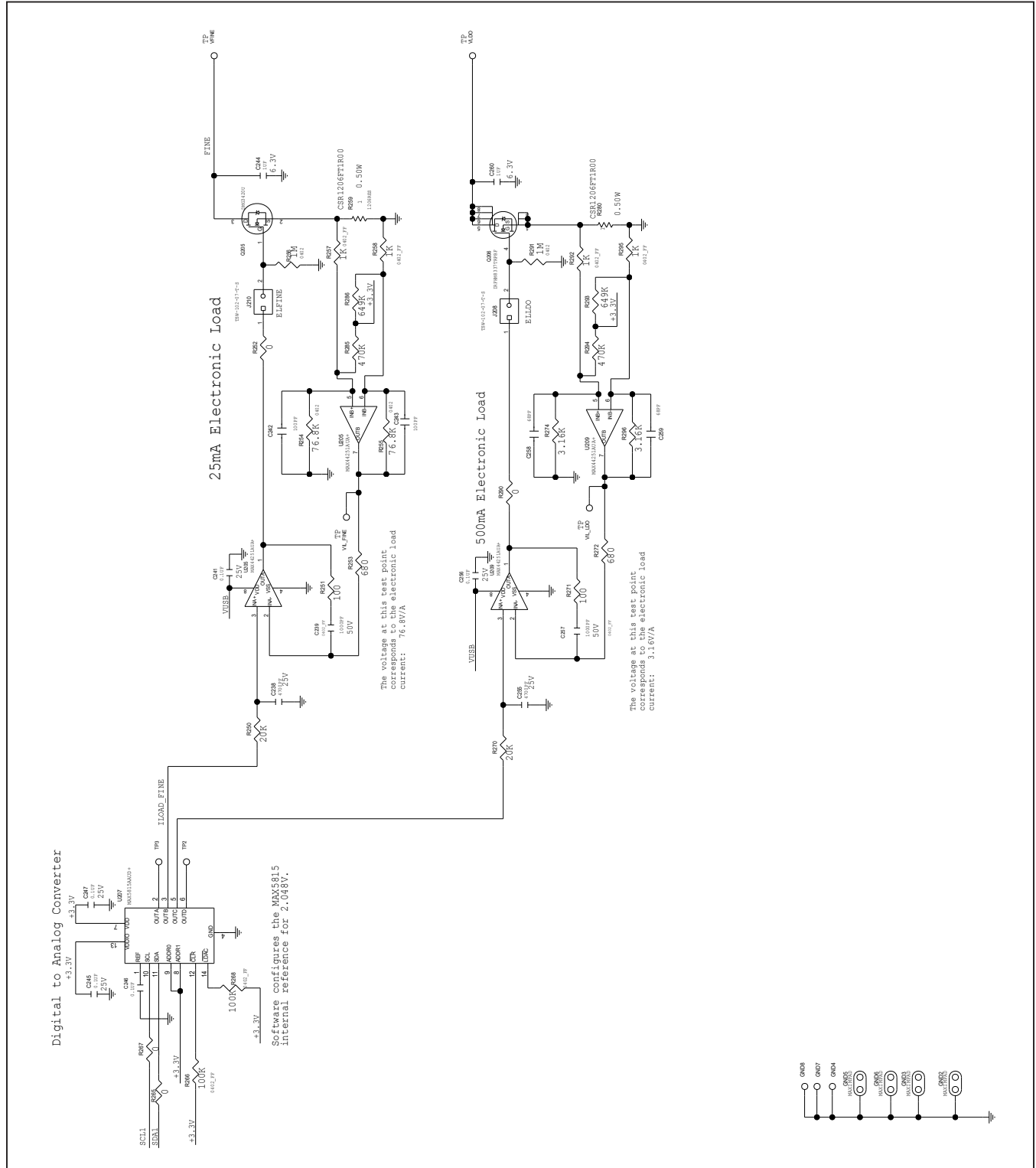

MAX77714 EV Kit Schematics (continued)

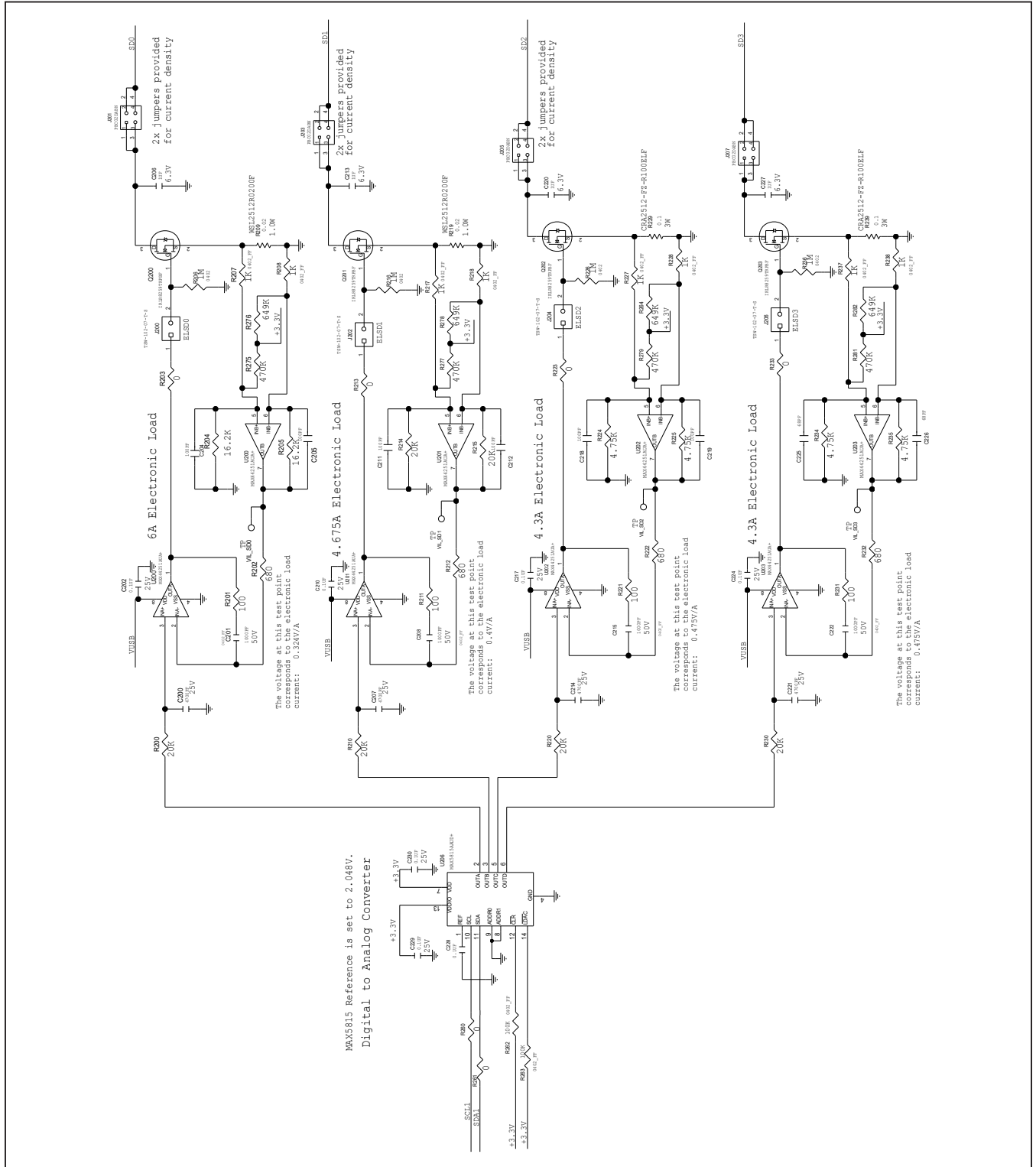

MAX77714 EV Kit Schematics (continued)

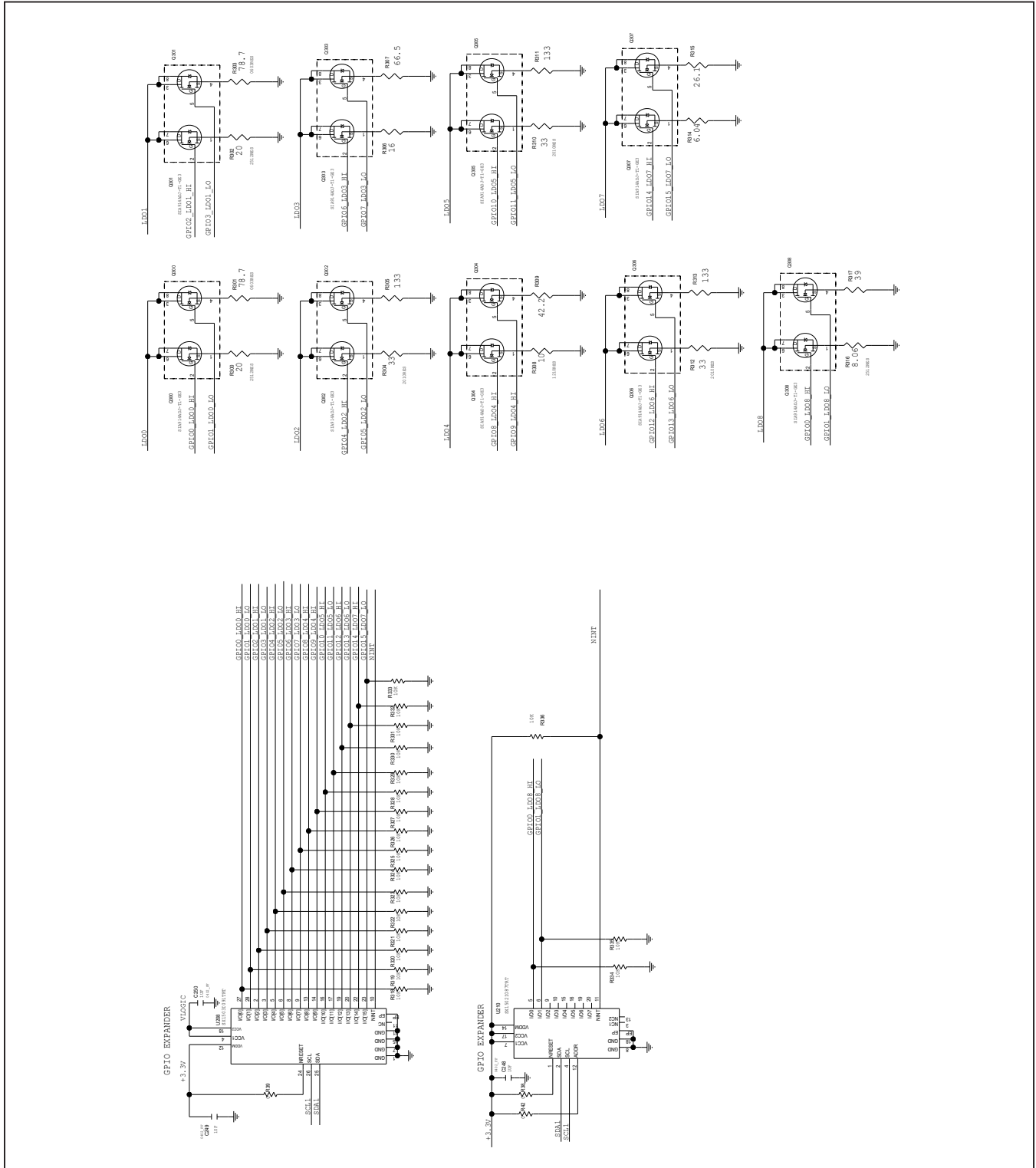

MAX77714 EV Kit Schematics (continued)

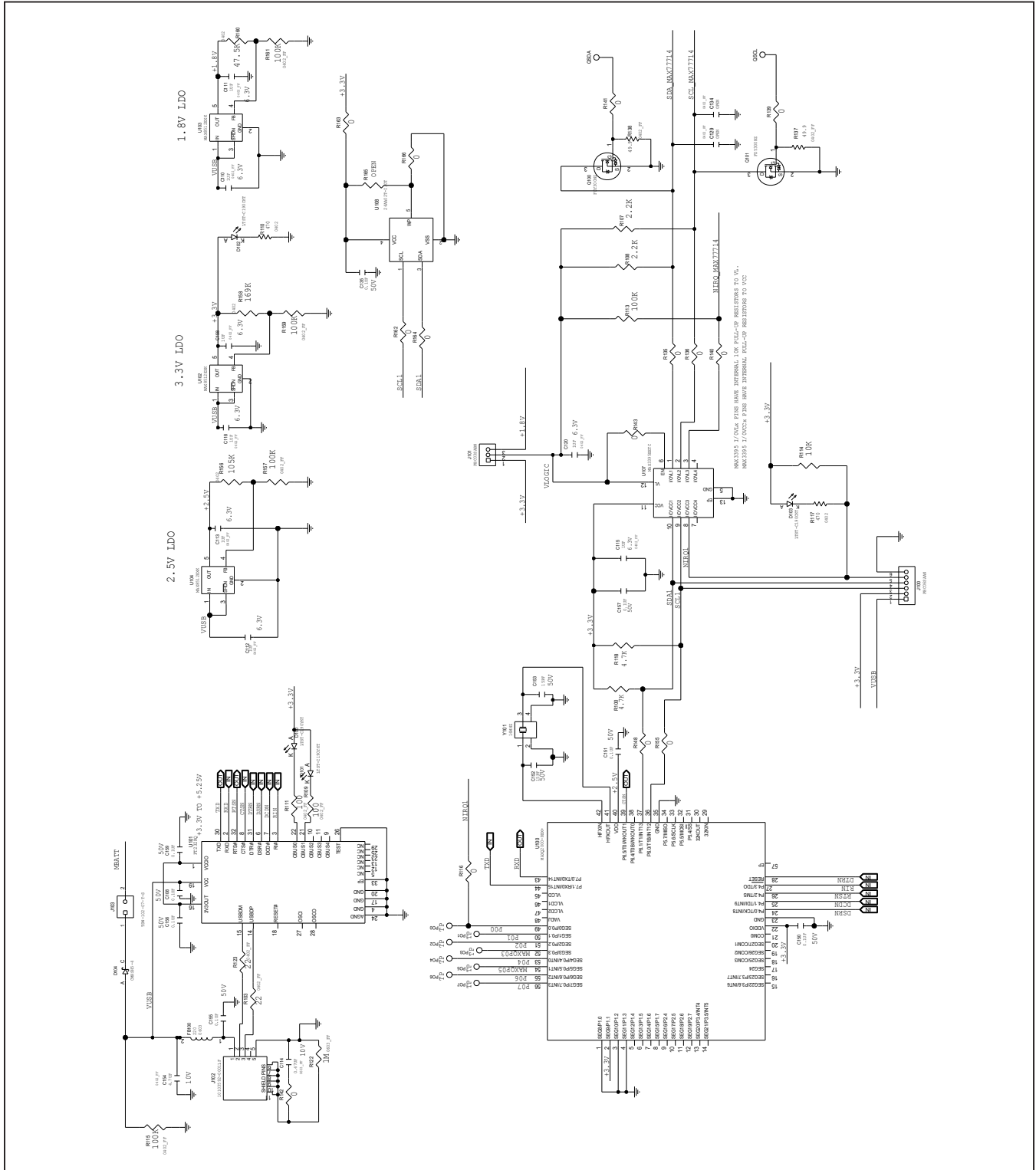

MAX77714 EV Kit PCB Layouts

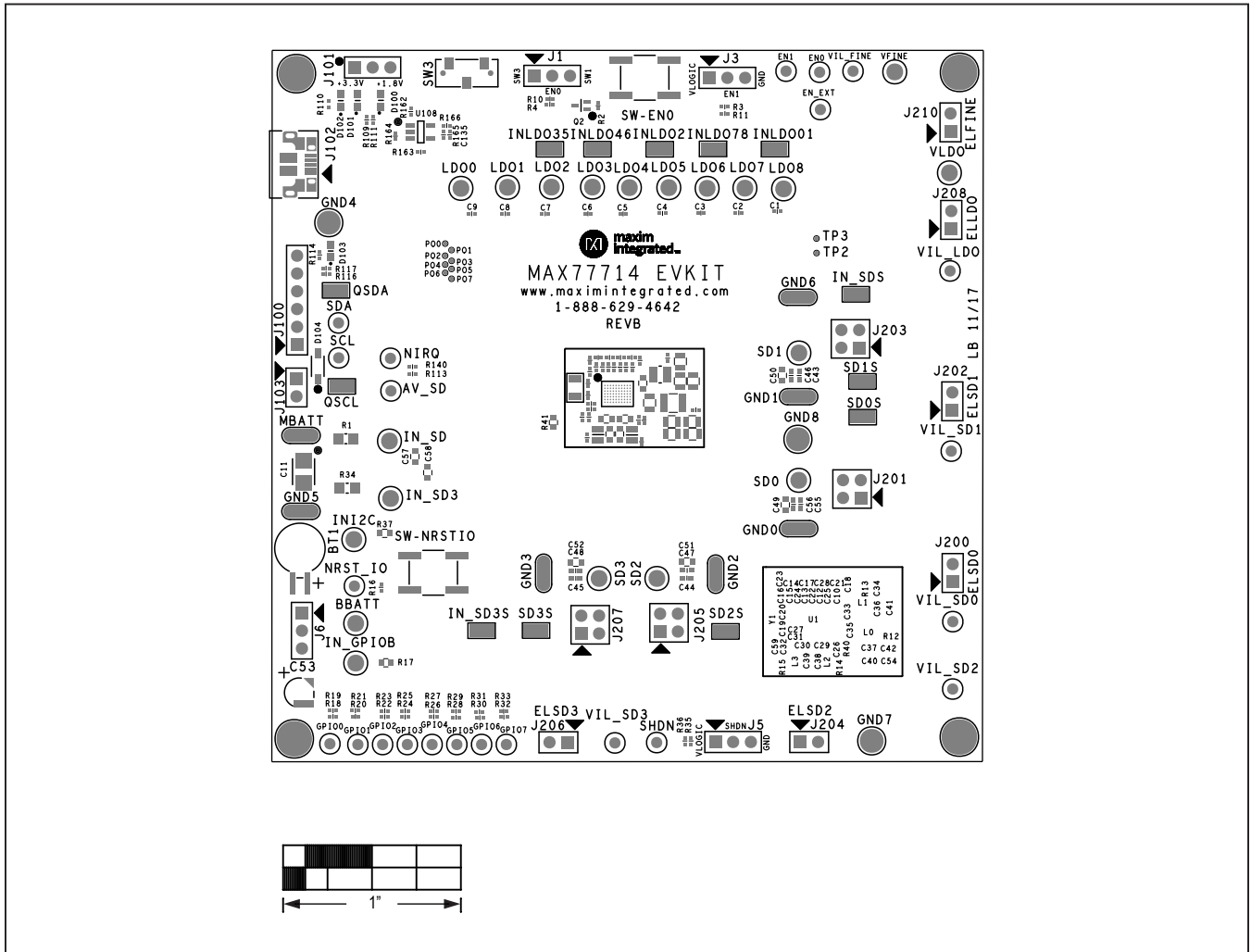

MAX77714 EV Kit Component Placement Guide—Top Silkscreen

MAX77714 EV Kit PCB Layouts (continued)

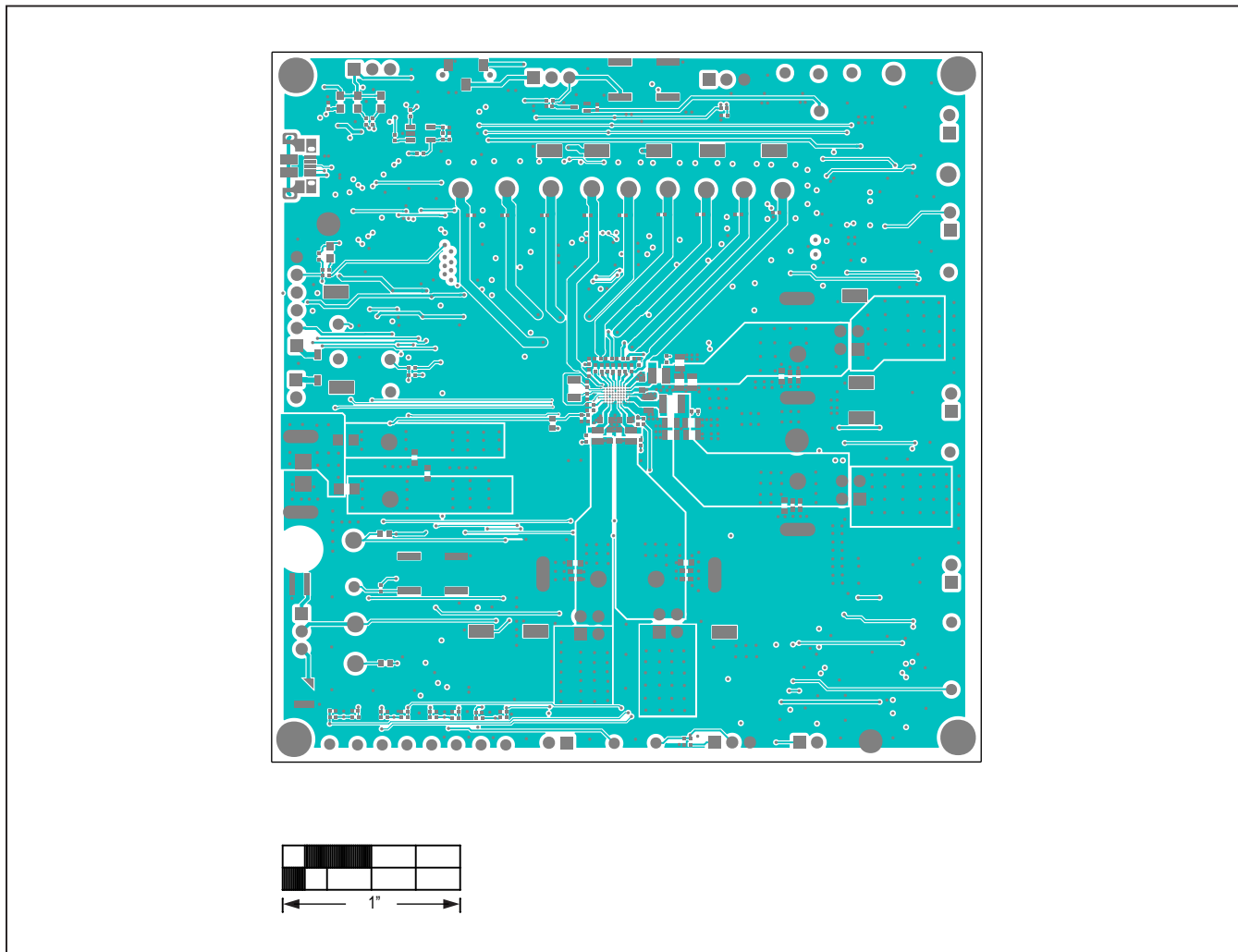

MAX77714 EV Kit PCB Layout—Top Layer

MAX77714 EV Kit PCB Layouts (continued)

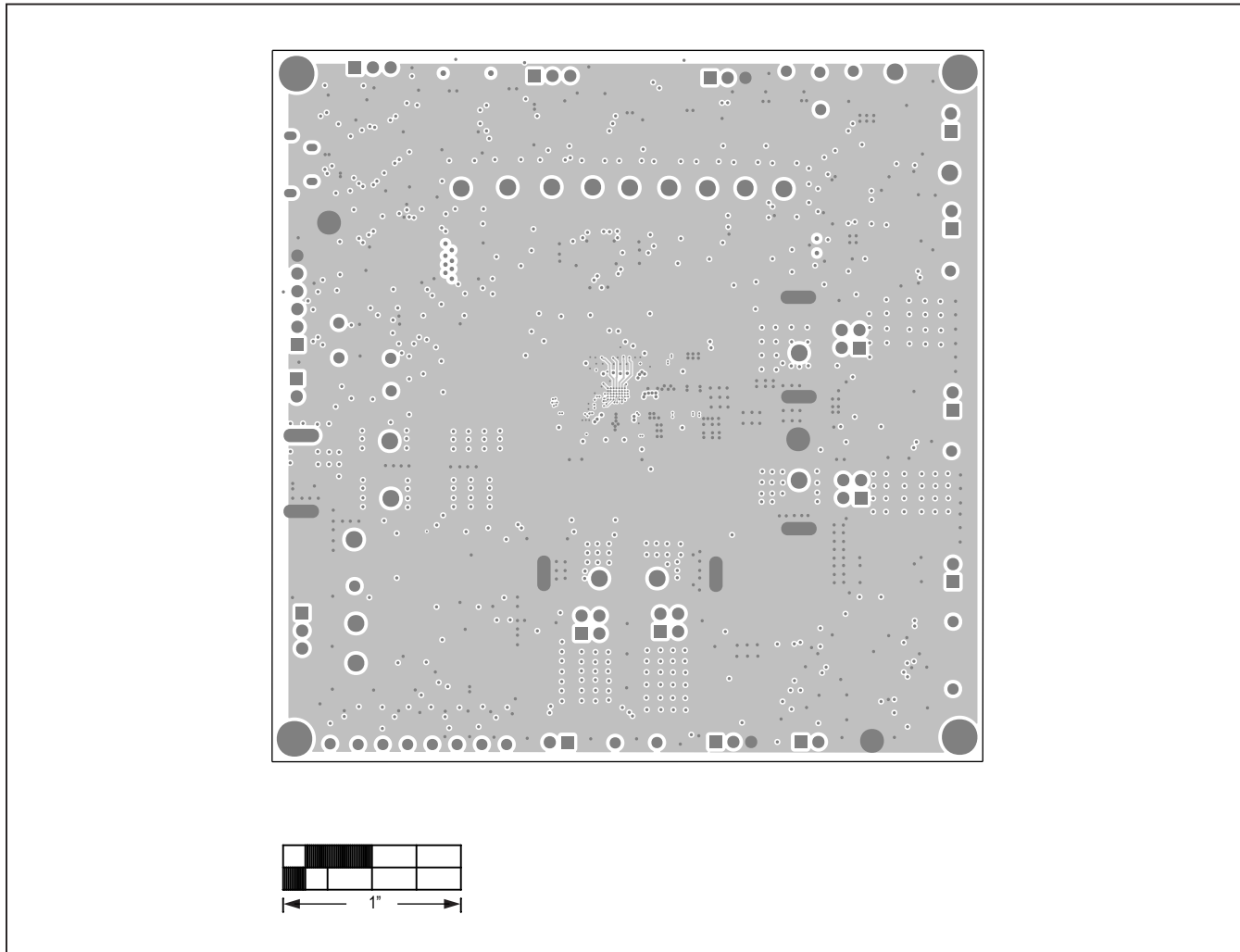

MAX77714 EV Kit PCB Layout—Internal Layer 2

MAX77714 EV Kit PCB Layouts (continued)

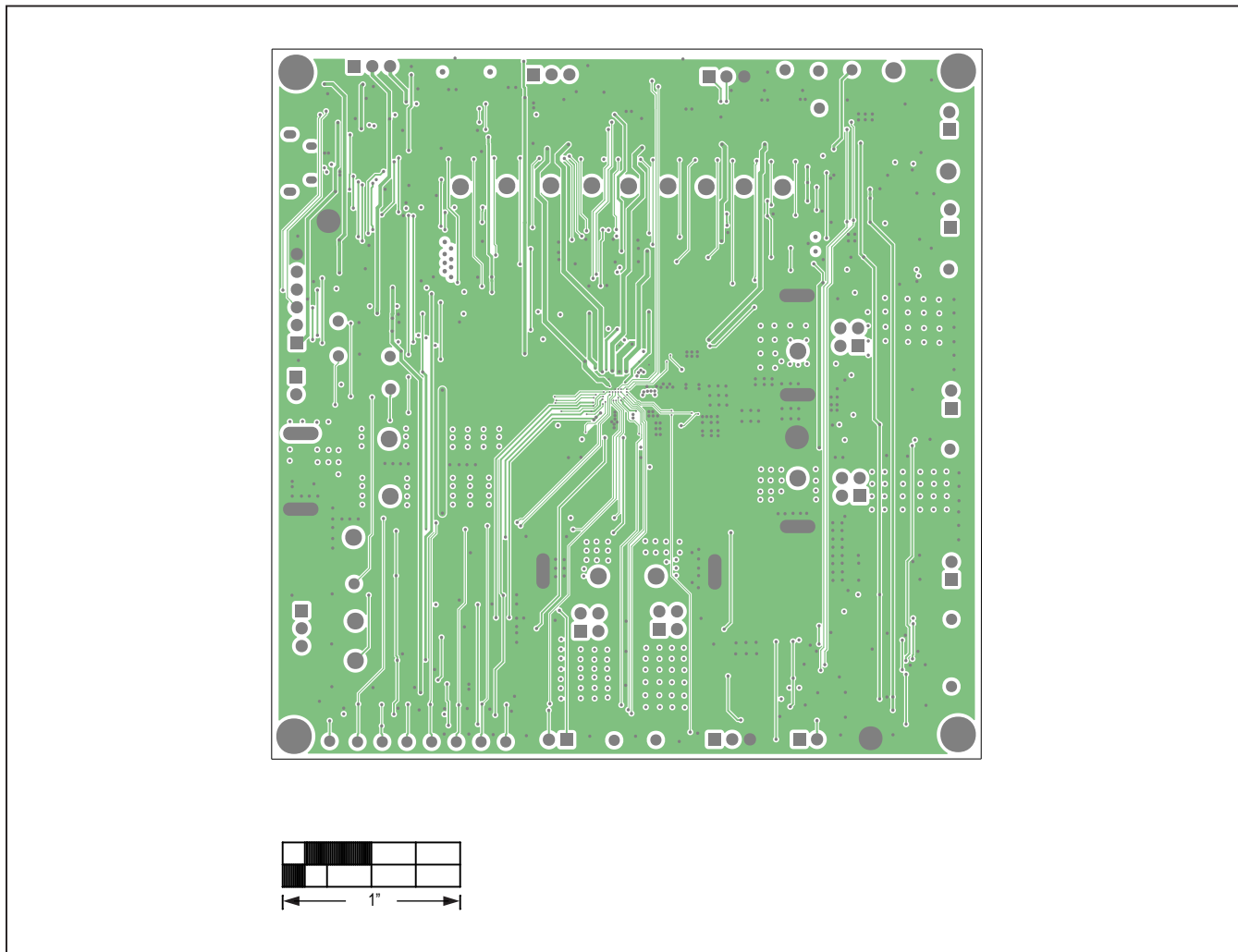

MAX77714 EV Kit PCB Layout—Internal Layer 3

MAX77714 EV Kit PCB Layouts (continued)

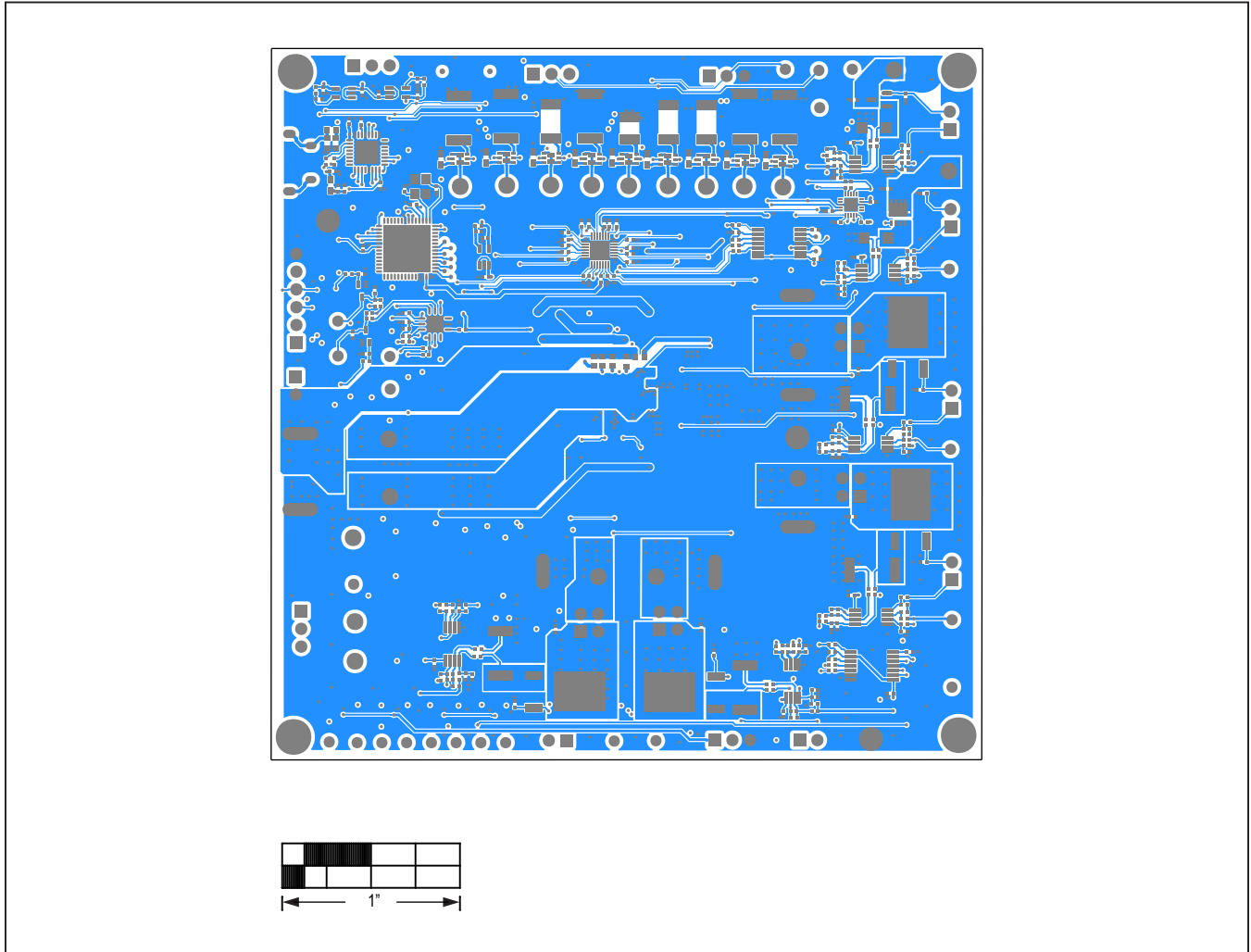

MAX77714 EV Kit PCB Layout—Bottom Layer

MAX77714 EV Kit PCB Layouts (continued)

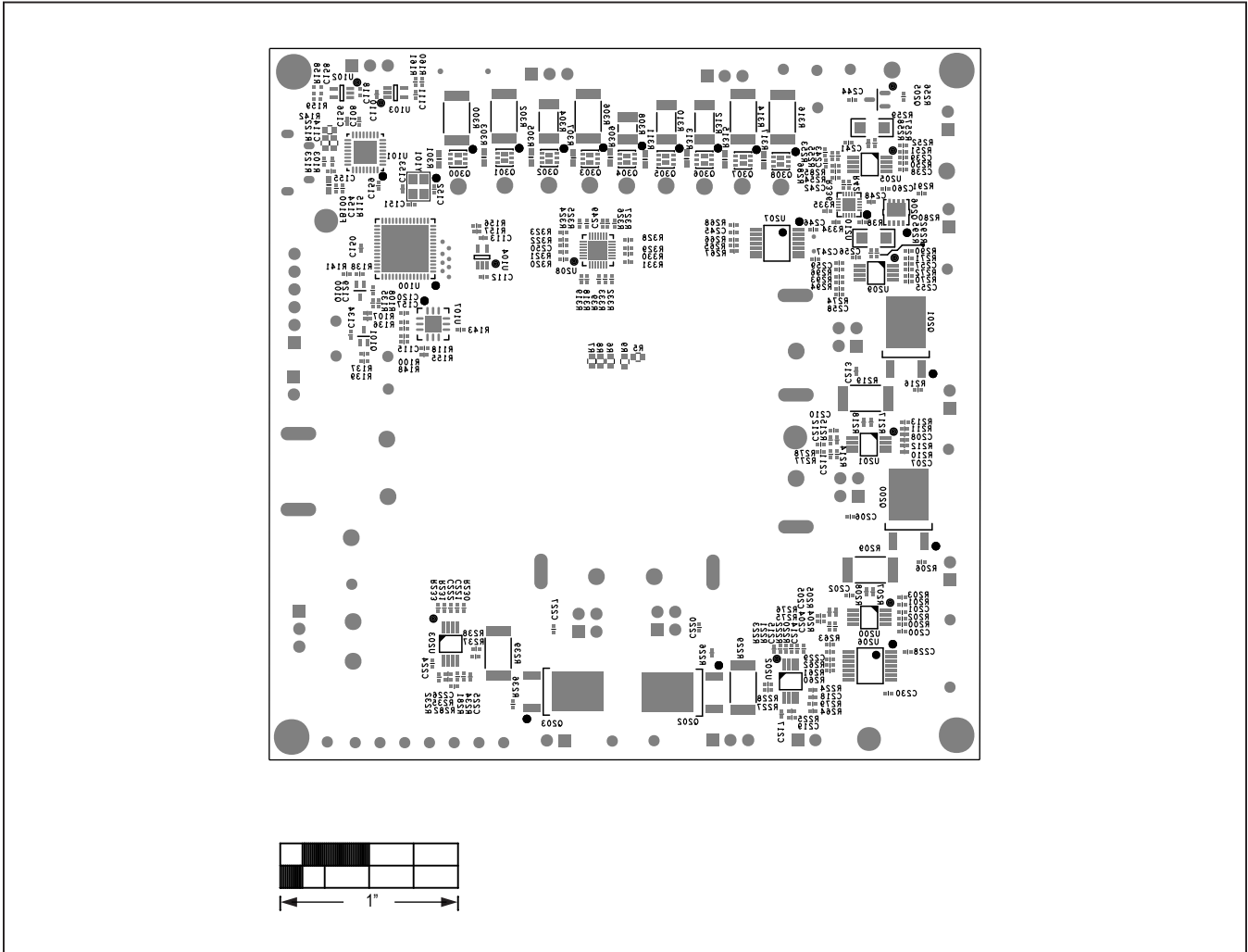

MAX77714 EV Kit Component Placement Guide—Bottom Silkscreen

Revision History

REVISION NUMBER	REVISION DATE	DESCRIPTION	PAGES CHANGED
0	5/18	Initial release	—

For pricing, delivery, and ordering information, please contact Maxim Direct at 1-888-629-4642, or visit Maxim Integrated's website at www.maximintegrated.com.

Maxim Integrated cannot assume responsibility for use of any circuitry other than circuitry entirely embodied in a Maxim Integrated product. No circuit patent licenses are implied. Maxim Integrated reserves the right to change the circuitry and specifications without notice at any time.