

Mini Top View LEDs EAPL2214RA0

PRELIMINARY



Features

- White SMT package.
- Optical indicator.
- Wide viewing angle.
- Soldering methods: IR reflow soldering
- Available on tape and reel
- Pb-free
- The product itself will remain within RoHS compliant version.

Applications

- Optical indicators.
- Coupling into light guides.
- Backlighting (LCD, cellular phones, switches, keys, displays, illuminated advertising, general lighting).
- Coupling into light guides; Interior automotive lighting (e.g. dashboard backlighting, etc.).

Device Selection Guide

Chip Materials	Emitted Color	Resin Color
AlGaInP	Brilliant Red	Water Clear

Absolute Maximum Ratings (Ta=25°C)

Parameter	Symbol	Rating	Unit
Reverse Voltage	VR	5	V
Forward Current	IF	30	mA
Peak Forward Current (Duty 1/10 @1KHz)	IFP	100	mA
Power Dissipation	Pd	110	mW
Electrostatic Discharge (HBM)	ESD	2000	V
Operating Temperature	Topr	-40 ~ +85	°C
Storage Temperature	Tstg	-40 ~ +90	°C
Soldering Temperature	Tsol	Reflow Soldering : 260 °C for 10 sec. Hand Soldering : 350 °C for 3 sec.	

Electro-Optical Characteristics (Ta=25°C)

Parameter	Symbol	Min.	Typ.	Max.	Unit	Condition
Luminous Intensity	Iv	72	-----	180	mcd	IF=20mA
Viewing Angle	2θ1/2	-----	120	-----	deg	
Peak Wavelength	λp	-----	632	-----	nm	
Dominant Wavelength	λd	616.5	-----	634.5	nm	
Spectrum Radiation Bandwidth	Δλ	-----	20	-----	nm	
Forward Voltage	VF	1.75	-----	2.35	V	
Reverse Current	IR	-----	-----	10	μA	VR=5V

Note:

1. Tolerance of Luminous Intensity: ±11%
2. Tolerance of Dominant Wavelength: ±1nm
3. Tolerance of Forward Voltage: ±0.1V

Bin Range of Luminous Intensity

Bin	Min	Max	Unit	Condition
Q1	72	90	mcd	IF=20mA
Q2	90	112		
R1	112	140		
R2	140	180		

Note: Tolerance of Luminous Intensity: ±11%

Bin Range of Dominant Wavelength

Group	Bin	Min	Max	Unit	Condition
A	E4	616.5	622.5	nm	IF=20mA
	E5	620.5	626.5		
	E6	624.5	630.5		
	E7	628.5	634.5		

Note: Tolerance of Dominant Wavelength: ±1nm

Bin Rang of Forward Voltage

Group	Bin	Min	Max	Unit	Condition
B	0	1.75	1.95	V	IF=20mA
	1	1.95	2.15		
	2	2.15	2.35		

Note: Tolerance of Forward Voltage $\pm 0.1V$

Typical Electro-Optical Characteristics Curves

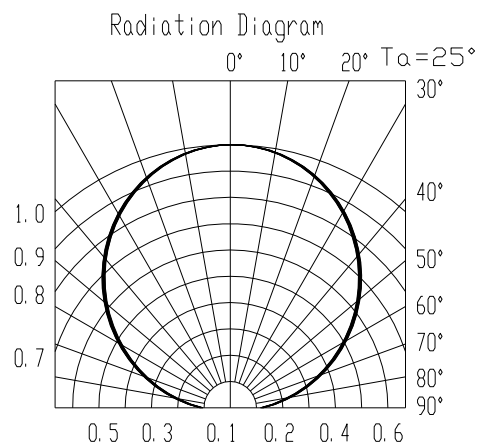
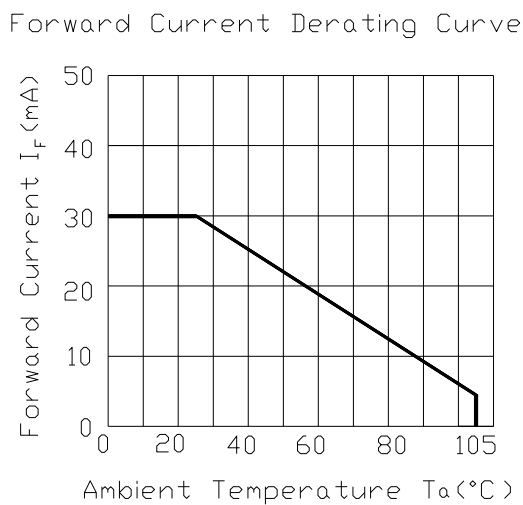
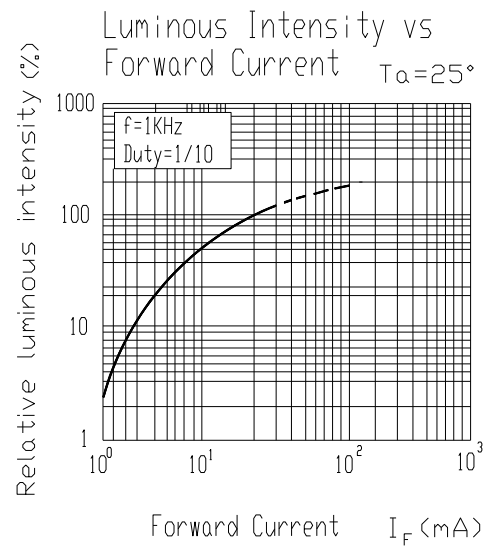
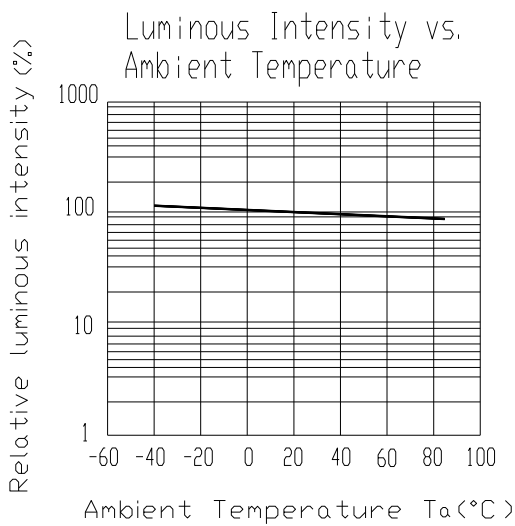
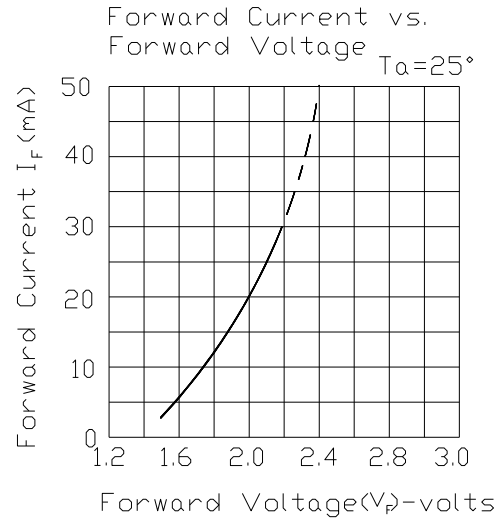
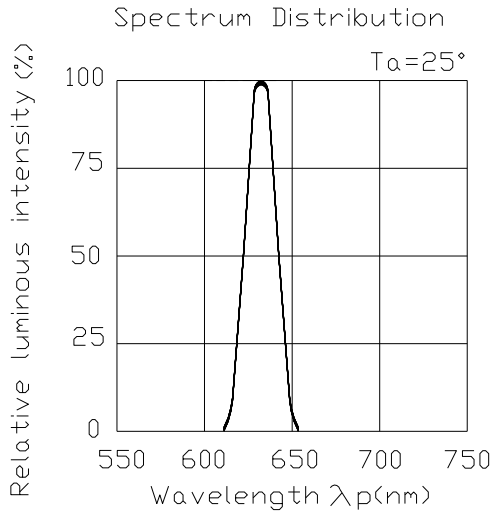

Package Dimension

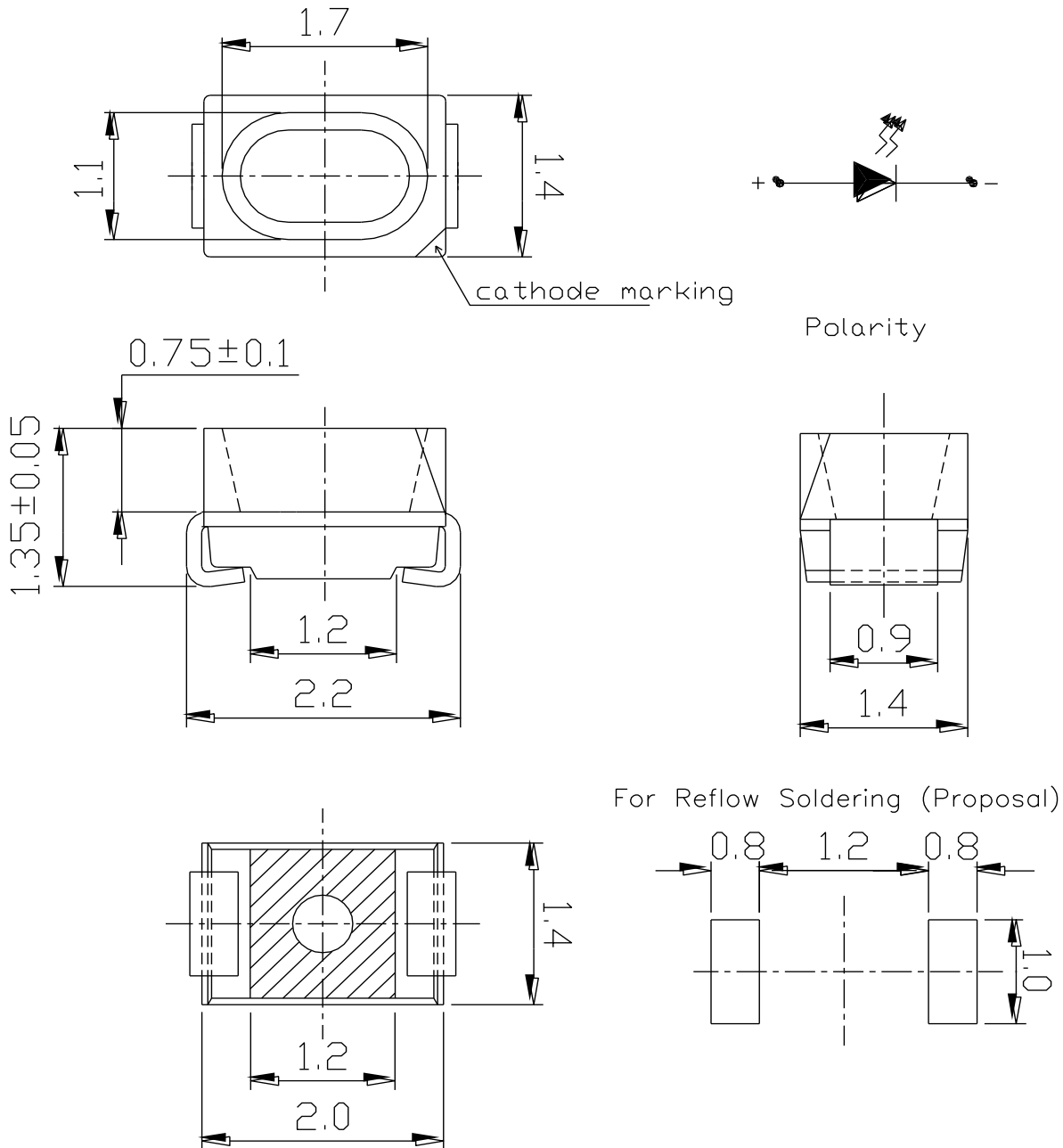

Note: Tolerances unless mentioned ± 0.1 mm. Unit = mm

Moisture Resistant Packing Materials

Label Explanation



- CPN: Customer's Product Number
- P/N: Product Number
- QTY: Packing Quantity
- CAT: Luminous Intensity Rank
- HUE: Dom. Wavelength Rank
- REF: Forward Voltage Rank
- LOT No: Lot Number

Reel Dimensions

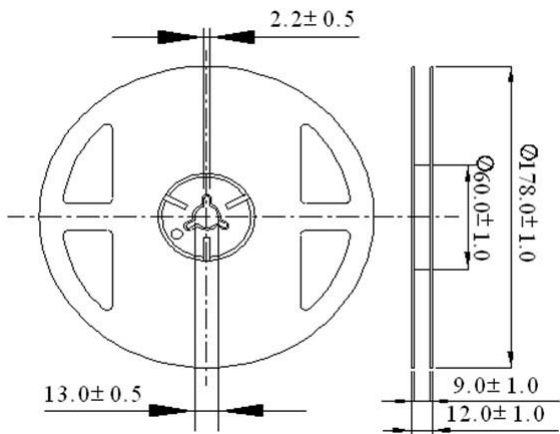

Carrier Tape Dimensions: Loaded Quantity 2000 pcs Per Reel

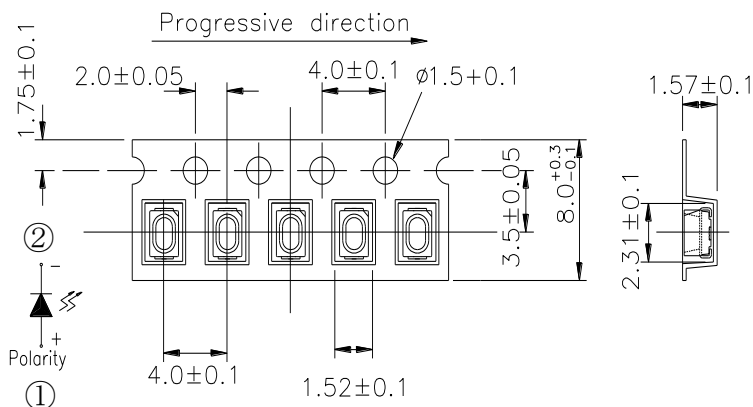

Note: Tolerances unless mentioned ± 0.1 mm. Unit = mm

Moisture Resistant Packing Process

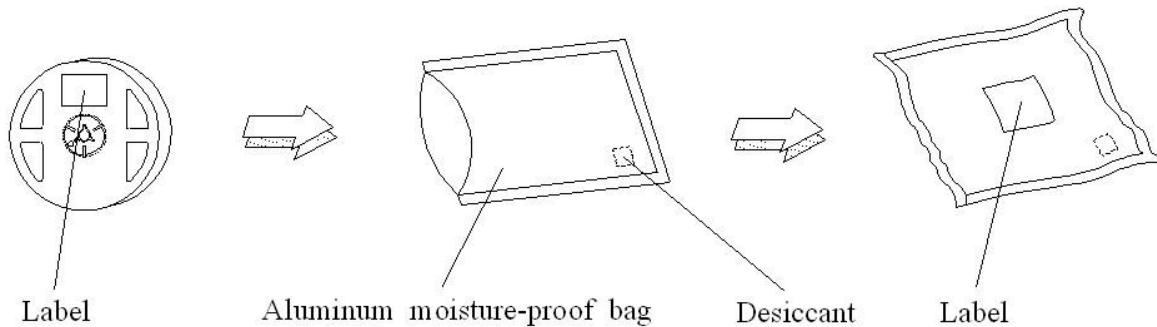

Note: Tolerances unless mentioned $\pm 0.1\text{mm}$. Unit = mm

Precautions for Use

1. Over-current-proof
Customer must apply resistors for protection; otherwise slight voltage shift will cause big current change (Burn out will happen).
2. Storage
 - 2.1 Do not open moisture proof bag before the products are ready to use.
 - 2.2 Before opening the package, the LEDs should be kept at 30°C or less and 90%RH or less.
 - 2.3 After opening the package: The LED's floor life are 168 hours under 30°C or less and 60% RH or less.
If unused LEDs remain, it should be stored in moisture proof packages.
 - 2.4 If the moisture absorbent material (silica gel) has faded away or the LEDs have exceeded the storage time, baking treatment should be performed using the following conditions.
Baking treatment : $60\pm 5^{\circ}\text{C}$ for 24 hours.
3. Soldering Condition
 - 3.1 Pb-free solder temperature profile
 - 3.2 Reflow soldering should not be done more than two times.
 - 3.3 When soldering, do not put stress on the LEDs during heating.
 - 3.4 After soldering, do not warp the circuit board.

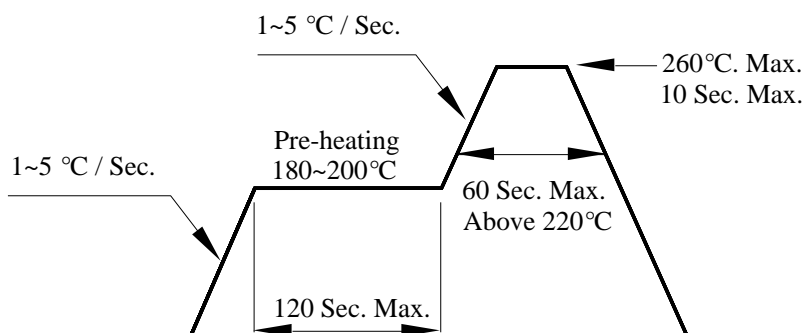

4. Soldering Iron

Each terminal is to go to the tip of soldering iron temperature less than 280°C for 3 seconds within once in less than the soldering iron capacity 25W. Leave two seconds and more intervals, and do soldering of each terminal. Be careful because the damage of the product is often started at the time of the hand solder.

5. Repairing

Repair should not be done after the LEDs have been soldered. When repairing is unavoidable, a double-head soldering iron should be used (as below figure). It should be confirmed beforehand whether the characteristics of the LEDs will or will not be damaged by repairing.

