



HoverflyOPEN™  
User's Guide





The information contained in this publication regarding device applications and use is intended by way of suggestion only and may be superseded by updates or revisions. No representation or warranty is given and no liability is assumed by Hoverfly Technologies, Inc. with respect to the accuracy or use of such information, or infringement of patents arising from such use or their compliance to any industry standards. Use of Hoverfly Technologies, Inc. products as critical components in any life-saving systems is not authorized except with express written approval. No licenses are conveyed, implicitly or otherwise, under intellectual property rights.

Copyright © Hoverfly Technologies, Inc. 2012. All rights reserved. Except as permitted under the Copyright Act of 1976 US Code § 102 101-122, no part of this publication may be reproduced or distributed in any form or by any means, or stored in a database or retrieval system, without the prior written permission of Hoverfly Technologies, Inc.

This document is distributed by Hoverfly Technologies, Inc. electronically and may not be printed and distributed without written permission.

Cover Art and Illustrations Alfred D. Ducharme except where noted.

Written by Alfred D. Ducharme with editing provided by George Sapp.

**March 2012 Rev 1.0**



## **Thank You for Purchasing the HoverflyOPEN™!**

We started this company with one goal in mind...to make things that hover and fly! All of us have enjoyed the thrill of RC for many years. We have poured our heart and souls into our hobbies and flown, drove, and sailed just about everything. In the last few years, the feasibility of making Inertial Motion Units (IMUs) at a price that the average hobbyist could afford has become a reality. Many high-volume consumer applications utilizing gyroscope, accelerometer, pressure, magnetometer, and GPS have shrunk both the size and cost of these sophisticated devices. The affordability of IMUs has enabled an explosion of activity in the building and flying of multi-rotor aircraft. Part of this is the inherent need for hobbyist to build something new to fly or control. The rest of the enthusiasm lies in the amazing flight capabilities of hovering multi-rotor aircraft. They enable the pilot to navigate the airspace in ways only imaginable a few years ago. Add a camera, and the user can gain amazing views of the world around us.

The HoverflyOPEN™ is a bit different from our other flight controllers like the HoverflySPORT™ and HoverflyPRO™ in that we provide documentation on the electronics used on the board. Additionally, a small prototyping area is available for your to experiment with your ideas. The user can use the proprietary firmware we provide on our website or experiment with your own firmware. We hope you are as excited as we are about the possibilities.

We hope that you will enjoy using the HoverflyOPEN™ for many years. Please understand that software is never finished. We will periodically release new versions of firmware which can easily be loaded onto the HoverflyOPEN™ board. Make sure you check our site for updates to this User's Guide and our firmware.

The Hoverfly Team!

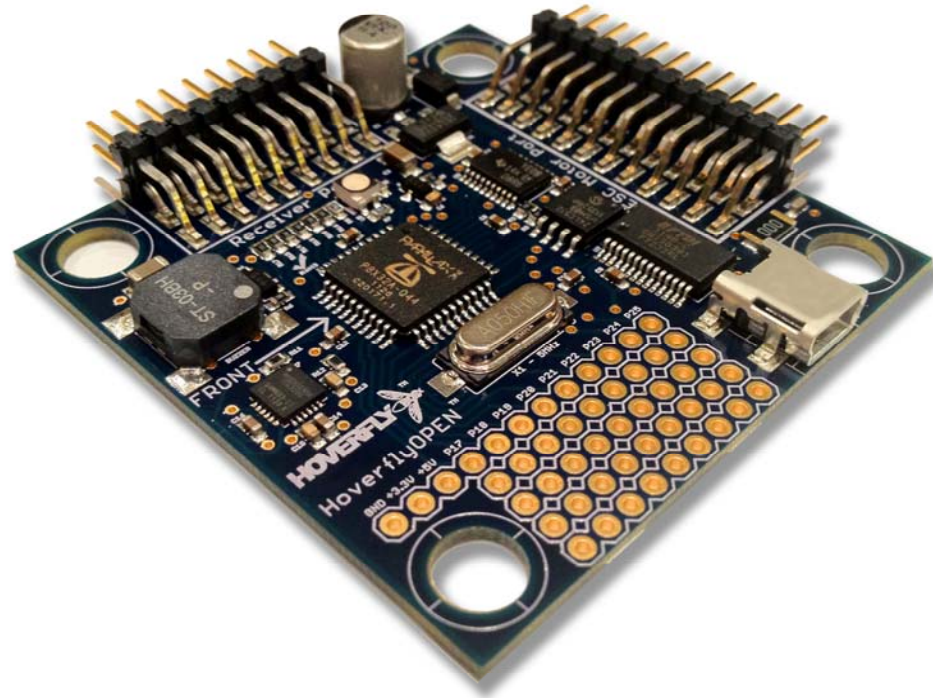

## HoverflyOPEN™

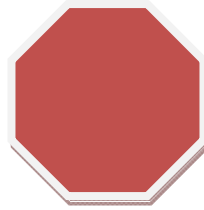

## **A Note on Safety**

The operation of any flying machine whether remote controlled or not can be dangerous. It is very important that you observe all necessary safety precautions before (and after) flying. A safety check list is provided at the end of this guide for your reference; please make sure you use it. Furthermore, this user guide is not necessarily fully inclusive of all information you may need to get your aircraft flying – this depends on how you have built your aircraft – therefore please bear in mind that the information herein is intended as a guide and does not in any way guarantee or undertake to guarantee your success. Lastly, since this guide has been compiled overtime time from numerous builds, it may contain inaccuracies; do not rely on it solely.

All ways maintain control of your aircraft! One moment of showing-off can lead to a lifetime of regret.

***There are old pilots and bold pilots but there are few old bold pilots.***



# Table of Contents

<b>1</b>	<b>About this guide</b> .....	<b>10</b>
1.1	<i>Content Division</i> .....	10
1.2	<i>When to use the guide</i> .....	11
1.3	<i>Format</i> .....	11
1.4	<i>Revisions</i> .....	11
<b>2</b>	<b>Introduction to the HoverflyOPEN™</b> .....	<b>12</b>
2.1	<i>Multi-Rotor Aircraft</i> .....	12
2.2	<i>Purpose</i> .....	13
2.3	<i>Function of the HoverflyOPEN™</i> .....	14
2.4	<i>HoverCore™</i> .....	20
<b>3</b>	<b>What's included</b> .....	<b>21</b>
3.1	<i>In the box</i> .....	21
3.2	<i>Also included</i> .....	21
<b>4</b>	<b>Installation and Building</b> .....	<b>22</b>



4.1	<i>Vibration</i> .....	22
4.2	<i>Configurations</i> .....	23
4.3	<i>Transmitter</i> .....	24
4.3.1	Channel Requirement .....	24
4.4	<i>Receiver</i> .....	26
4.5	<i>Motor Wiring Harness</i> .....	27
4.5.1	Proper Soldering (read even if you know how to solder) .....	27
4.5.2	Current vs. Wire Gauge .....	28
4.5.3	Battery Source.....	29
4.5.4	Electronic Speed Controllers (ESCs) .....	30
4.5.5	Connectors .....	34
4.5.6	Wiring Harness Layout .....	36
4.5.7	Power Filtering .....	38
4.6	<i>Airframe</i> .....	38
4.6.1	Airframe Vibration Dampening.....	38
4.6.2	Stand-offs .....	39
4.7	<i>Brushless Motors</i> .....	39
4.8	<i>Propellers</i> .....	40
4.9	<i>Canopy</i> .....	41
4.10	<i>Connecting the HoverflyOPEN™</i> .....	41
4.10.1	HoverflyOPEN Orientation .....	42



4.10.2	Receiver Connection to HoverflyOPEN™	43
4.10.3	Configurations - "+" and "X"	44
4.10.4	Configurations – Hex and Y6	45
4.10.5	Configurations – Octo and X8	46
<b>5</b>	<b>Operation</b>	<b>47</b>
5.1	<i>Before Flight</i>	47
5.2	<i>Setting Gains</i>	48
5.3	<i>Arming the HoverflyOPEN™</i>	49
5.4	<i>Bench Testing</i>	52
5.5	<i>Flight Controls</i>	53
5.6	<i>Basic Flight Mode</i>	54
5.7	<i>Advanced Flight Mode</i>	54
5.7.1	Altitude Hold Function	54
<b>6</b>	<b>Update Client and Setup Utility</b>	<b>56</b>
6.1	<i>Firmware Updates</i>	57
6.1.1	Update Procedure	57
6.2	<i>Setup Utility</i>	61
6.2.1	General Tab	61
6.2.2	Parameters Tab	63





6.2.3	Diagnostics Tab .....	63
<b>7</b>	<b>The Open Stuff .....</b>	<b>64</b>
7.1.1	Power .....	64
7.1.2	3-Axis Digital Gyroscope.....	64
7.1.3	HoverflyOPEN Pinout Description .....	66
	<b>Appendix A – Physical Dimensions.....</b>	<b>67</b>
	<b>Appendix B - Technical Specifications .....</b>	<b>68</b>
	<b>Appendix C - Quick Start Guide.....</b>	<b>69</b>
	<b>Appendix D - Connection Reference .....</b>	<b>70</b>
	<b>Appendix E – Schematic .....</b>	<b>71</b>

# 1 About this guide

Ideally this User's Guide represents the complete documentation for the HoverflyOPEN™. We will make corrections and revision changes as needed and certainly when new features are added.

**Quick Start Guide:** If you already have a multi-rotor aircraft built and just want to Plug-N-Fly™ you can jump directly to Appendix C – Quick Start Guide.

---

## 1.1 Content Division

This document is divided into the following chapters:

- Chapter 2, "Introduction to the HoverflyOPEN™" a description of the hardware.
- Chapter 3, "What's Included" a brief list of the items included with your product.
- Chapter 4, "Installation and Building" provides information on configurations, wiring, and mounting.
- Chapter 5, "Operation" explains the different flight modes and set-ups required.
- Chapter 6, "Update Client" describes the operation and use of the firmware Update Client.

---

## 1.2 When to use the guide

This guide is intended for builders and users of the HoverflyOPEN™. It should be used when first installing the unit, before first flying your aircraft, and throughout the use of the product. The guide assumes that the user has some knowledge of power and servo connections, basic electronics, and updating the firmware of electronic devices.

---

## 1.3 Format

The manual was formatted in Landscape mode to make it easier for the user to read on a typical widescreen display. This decision was made because it is distributed electronically rather than in printed hardcopy form.

---

## 1.4 Revisions

This guide should be considered a “living” document. There will almost certainly be errors both in form and function. Understand that new revision will be released periodically and you should check periodically for updates.

---

## 2 Introduction to the HoverflyOPEN™

This chapter is both an introduction to the HoverflyOPEN™ and multi-rotor aircraft in general. It is meant to be a resource for anyone just entering the hobby of building and flying multi-rotor aircraft. Even though many of the concepts presented here are known by experienced users, we hope that it is useful for all experience levels.

---

### 2.1 Multi-Rotor Aircraft

A multi-rotor aircraft is a remote controlled vehicle that utilizes more than one motor to provide lift and control flight. Just as a table must have three legs, at a minimum a multi-rotor aircraft must have three motors. It is possible to have fly a vehicle through the air using only two motors but that is not the intent of the HoverflyOPEN™. We consider a multi-rotor vehicle to contain at least three motors. However, this would require that one or more of the motors could turn on an axis perpendicular to the center of the airframe. Therefore, the minimum number of motors that must be used with the HoverflyOPEN™ is four (4). In addition, the orientation of these motors needs to be at equal angles. For a four motor aircraft the orientation of the motors would be all pointing in the same direction (usually up) and they would be positioned at the end of two straight crossed members as shown below, Fig. 1.



Figure 1. Basic Quadcopter or Quadrocopter motor configuration (frame by Droidworx)

---

## 2.2 Purpose

The HoverflyOPEN™ in a very basic sense is the *middle-man* between your control inputs and the motor electronic speed controllers (ESCs). Without it the aircraft would be nearly if not completely impossible to fly. The original stealth fighter, the Lockheed F-117 Nighthawk, first flown in 1981 was a revolutionary aircraft for two reasons. First, the stealth technology provided nearly invisible flight through the most sophisticated radar patrolled areas. Second, the best pilots couldn't fly it safely. How could this be? The same invisibility stealth technology yielded an aircraft with very unstable flight characteristics. So the second revolutionary aspect of the F-117 wasn't that it couldn't be flown



but rather a Flight Computer was needed between the pilot and the control surfaces. The HoverflyOPEN™ acts as the Flight Computer for your own multi-rotor aircraft.

The primary function of the HoverflyOPEN™ is to monitor the orientation of the aircraft and drive the multiple motors to achieve stable flight. The user's control inputs are then used to adjust the aircraft away from a stable orientation by pitching, rolling and yawing (spinning) the platform. These actions cause the aircraft to move in different directions so that it can effectively be flown within an airspace. Sounds pretty easy but to achieve this data from gyroscopes, accelerometers, and a pressure sensor are fused together thousands of times a second. This information is then used to make decisions on how to achieve the pilot's desired orientation.

The purpose of the HoverflyOPEN™ is to make the job of piloting an inherently unstable multi-rotor aircraft easy. Easy is a relative term here since some time on the sticks with other types of aircraft helps a great deal. However, we strive to make the HoverflyOPEN™ the most capable Flight Controller on the market and this means over time easy will be even easier. Ultimately, our goal is to make the flight of a multi-rotor aircraft effortless to the point that anyone can pick up a transmitter and give it a try without crashing.

---

## 2.3 Function of the HoverflyOPEN™

The HoverflyOPEN™ is designed to control several different configurations of multi-rotor aircraft. A more detailed description of the supported motor configurations is given in Chapter 4. For now it will be assumed that a basic four motor configuration, called a quadcopter, will be used with the HoverflyOPEN™.

The following diagram, Fig. 2, shows the basic connections that are needed for a quadcopter. As described in the previous Section 2.2, the HoverflyOPEN™ is the *middle-man* between the pilot and the motors of the aircraft. Therefore, the connections on the aircraft follow this methodology. The Transmitter sends the pilots control inputs (the sticks) to the Receiver on-board the aircraft. The Receiver is then connected to the HoverflyOPEN™. The HoverflyOPEN™ is then connected to the Brushless Electronic Speed Controllers (ESCs). The

function of the ESCs is to take information from the HoverflyOPEN™ and turn it into a 3-phase control signal. This 3-phase signal drives the brushless motor to attain a rotational speed to a certain number of revolutions per minute (RPM).

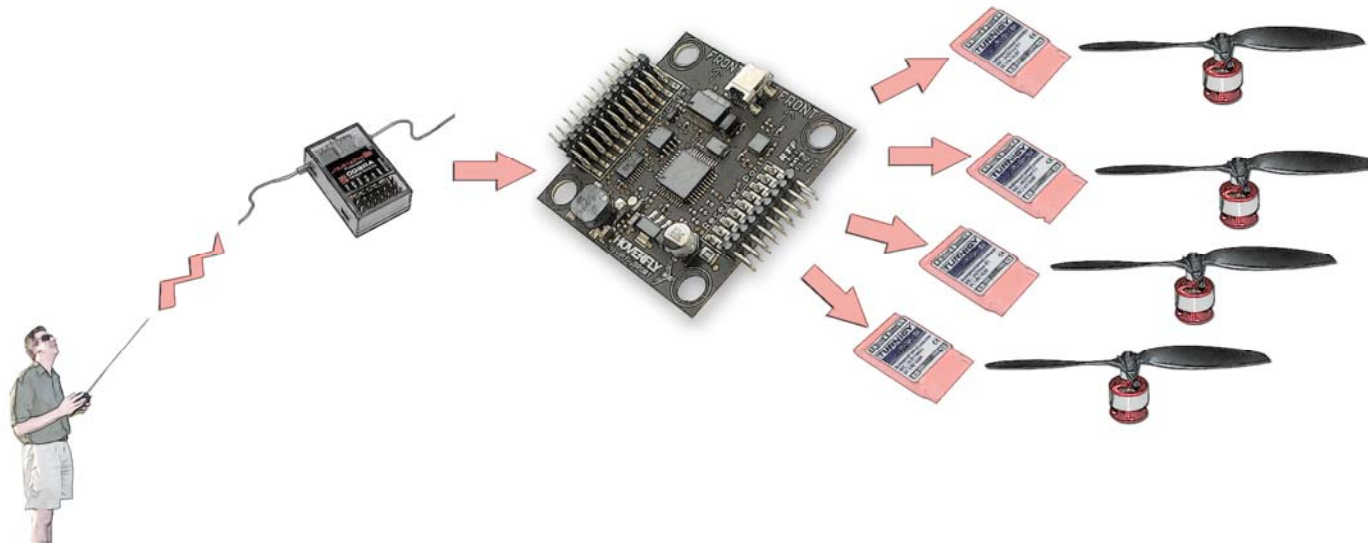

Figure 2. Diagram showing the operation of the HoverflyOPEN™ on a quadcopter (HoverflyPRO shown).

Ideally, under perfect windless conditions while the control inputs are centered the RPMs of all motors is equal. If a disturbance to the environment occurs such as a gust of wind, the HoverflyOPEN™ will change the RPMs each motor to continue to maintain the commanded center stick orientation. Thereby, maintaining the position of the aircraft.

In order to move the quadcopter forward the pilot would actuate the elevator (European customers may use left stick on mode 1 transmitters, maybe find a different term) control input up on the transmitter. This will cause the HoverflyOPEN™ to rotate the quadcopter forward called Pitch. If the pilot continues to hold the stick in the forward position the quadcopter will continue to pitch forward and eventually turn completely upside down. This is because in normal mode of flight (there are different modes discussed in Chapter 7) the control stick position is equal to the rotational rate of the quadcopter. More control input (moving the stick up further) results in a higher rotational rate. Less control input (moving the stick up slightly) results in a lower rotational rate.

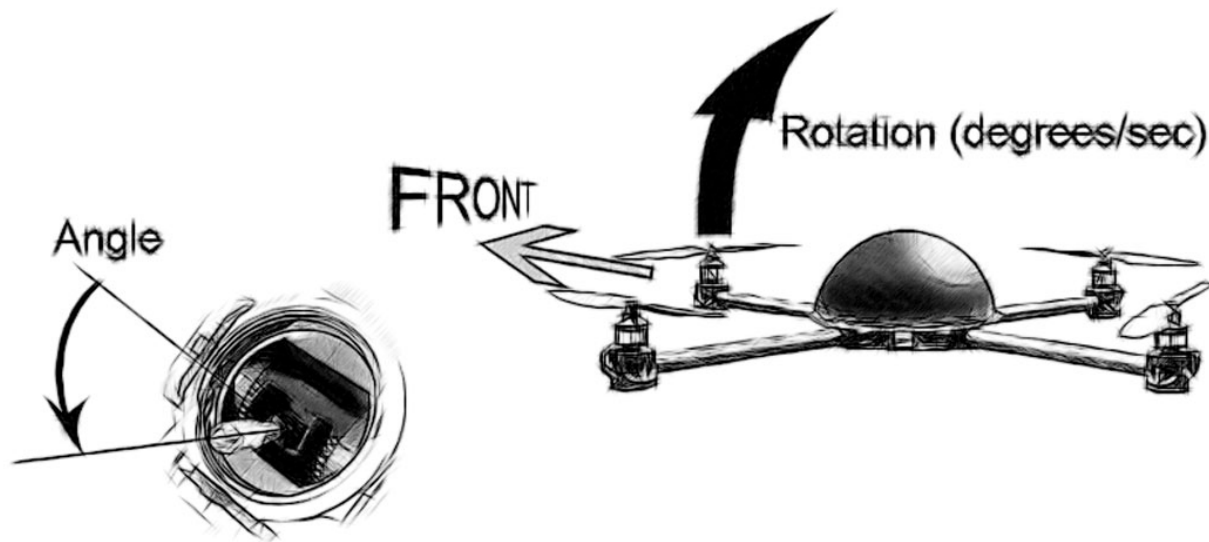

Figure 3. Rotational rate is proportional to stick angle.





Therefore, in order to move the quadcopter forward (without crashing it) the pilot must first initiate a slow rotational rate or pitch forward. The control input must be centered to maintain the angle-of-attack of the quadcopter. To stop the forward motion the control input must be reversed by moving the stick downward slightly to right the quadcopter. Then the stick is centered when the quadcopter is level to the ground.

The right control stick can also be actuated right and left. This will cause the quadcopter to rotate right and left called Roll. Once again the angle of the control stick is equal to rotation rate. Moving to the right would consist of first moving the stick right slightly, centering the stick to continue motion, then moving the stick left to level the quadcopter.

So far we have covered Pitch and Roll of the quadcopter but there are two other motions. First, the left control stick is used to control the altitude of the quadcopter by increasing and decreasing the speed of the motors (also referred to as throttle). This stick starts in the down position and corresponds to zero throttle and the motors will not spin. As the stick is moved up, the RPMs of the motors will increase. Every quadcopter has a *sweet spot* based on the weight of the aircraft and motor size where a constant altitude is maintained. This is called hovering and occurs when the quadcopter stays a single height above the ground. To increase the altitude of the quadcopter, the left stick is actuated upwards increasing the speed of the motors. This causes the quadcopter to rise and gain altitude. To hover at a new altitude the stick is moved back to the sweet spot. It will take some time and practice to discover the sweet spot and find it quickly after changing altitude. One of the challenges you will have is that the momentum of the quadcopter as it moves up and down requires some throttle counter action. In other words, after you change altitude you will need to increase or decrease the throttle around the sweet spot to fix the altitude. This is especially true when decreasing altitude. Once the quadcopter moves down to the desired altitude a swift increase in throttle will be required to offset the momentum of the falling aircraft.

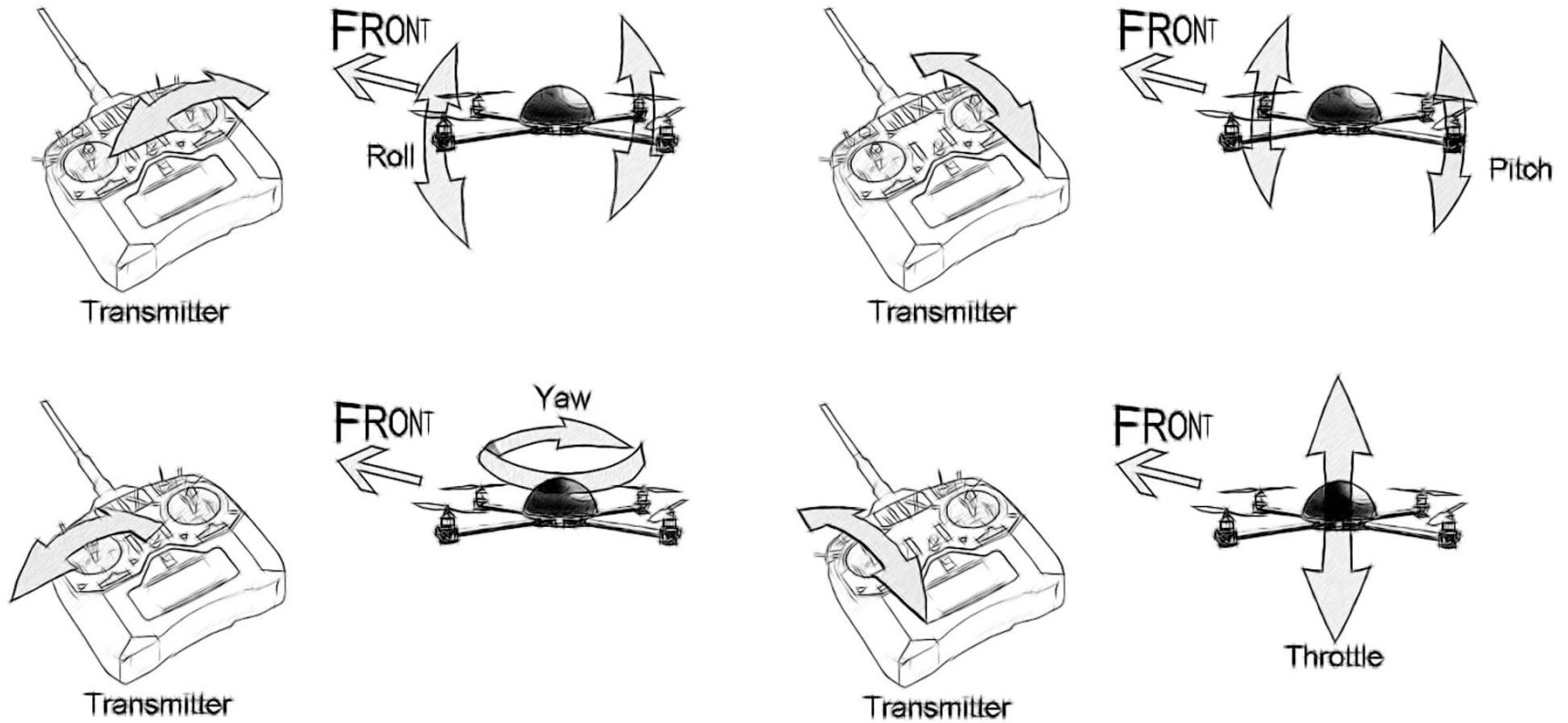

Figure 4. Control stick movement and aircraft roll, pitch, yaw, and throttle (altitude).



This leaves one more motion to cover called Yaw. Yaw is the spin of the quadcopter around the vertical axis. First, let's take a look at how the quadcopter counteracts Yaw. A traditional helicopter has a single rotor spinning in a constant direction. In addition, a helicopter has a tail boom with a smaller vertical rotor. The pitch or speed of the tail rotor is used to counteract the rotational force of the main rotor. Without the tail rotor (and many of us have unfortunately experienced this in a failure of the tail rotor) the helicopter will spin in the opposite direction of the main rotor. The tail rotor maintains the forward direction of the helicopter. Turning the helicopter or inducing Yaw requires a change in the tail rotor.

A quadcopter lacks the tail rotor of a traditional helicopter. So how is Yaw control achieved? Remember that the helicopter has a single rotor spinning in a constant direction. In order to control Yaw, a quadcopter has to balance the rotational force of the four motors. This is achieved very simply by spinning two motors in the clockwise (CW) direction and two motors in the counter-clockwise (CCW) direction. With all four motors spinning at the same RPM, the rotational forces are balanced so that the quadcopter doesn't spin. In order to command the quadcopter to spin in the CW direction this balance is adjusted. The speed of the CW motors is increased while the speed of the CCW motors is decreased. The overall thrust is maintained by this see-saw increase/decrease so that the quadcopter maintains altitude while turning in the CW direction. To Yaw the quadcopter in the CCW direction the see-saw balance is reversed.

The transmitter sticks allow the pilot to control the Roll, Pitch, Yaw, and altitude of the quadcopter. All of the complexity of flying a naturally unstable quadcopter is handled by the HoverflyOPEN™. Even environmental disturbances such as wind are monitored to enable consistent flight.

Flying a quadcopter with a HoverflyOPEN™ is a bit different from other aircraft such as planes and helicopters. Take for example the case where the quadcopter is flying into a gust of wind. The HoverflyOPEN™ will compensate for the wind so that the same user inputs achieve the same flight as in windless conditions. The pilot will then only need to adjust the throttle to maintain level flight similar to an airplane or



helicopter. The difference with a plane is the reaction that the aircraft will have to the increased airspeed over the wings. The quadcopter will feel the same going into wind whereas a plane will not.

Other flight modes such as Auto-Leveling change the flight characteristics of a multi-rotor aircraft and make it even easier to fly. These modes will be covered in Chapter 7. However, the beginning pilot should start with the basic rotational rate input flight mode.

---

## 2.4 HoverCore™

The HoverflyOPEN™ flight controller system is based on our core Sensor Data Fusion technology called HoverCore™. Lots of data from accelerometers and gyroscopes is useless no matter how fast you sample if the data is not fused effectively to provide stable flight control outputs. Our propriety HoverCore™ algorithm utilizes parallel processing architecture to independently collect sensor data. Then the algorithm utilizes custom digital filtering to extract only the necessary variables from all available data. The flight control algorithm utilizes the data it needs to generate Pulse-Width-Modulated (PWM) signals to accurately control external ESCs. All of this happens hundreds of times a second to provide reliable and highly stable flight control.

## 3 What's included

---

### 3.1 In the box

The following items should all be included with your HoverflyOPEN™ product:

- HoverflyOPEN™
- Vibration Grommets

### 3.2 Also included

In addition to the hardware you purchased the following is included with your purchase:

- HoverflyOPEN™ User's Guide (this manual) – Downloadable in PDF format from <http://www.hoverflytech.com/Documentation.html>
- Support Ticket System and Knowledgebase – <http://hoverflytech.zendesk.com>
- Firmware Update Client - [http://www.hoverflytech.com/Software\\_Updates.html](http://www.hoverflytech.com/Software_Updates.html)
- Set-Up Utility - [http://www.hoverflytech.com/Software\\_Updates.html](http://www.hoverflytech.com/Software_Updates.html)
- Free firmware updates – Using the free Update Client
- Building tutorials - <http://www.youtube.com/watch?v=7DHoLYf5pMA>

**IMPORTANT:** Check your Update Client for firmware updates often. Updates will include new features and possibly critical revisions of the firmware.

## 4 Installation and Building

In this section you will find detailed information concerning multi-rotor configurations, wiring, and installing the HoverflyOPEN™. It is recommended that even experienced builders read this chapter carefully. Proper operation of the HoverflyOPEN™ relies on the proper installation of the electrical and mechanical parts of the aircraft. Failure to carefully build your aircraft and properly install the HoverflyOPEN™ WILL result in POOR performance and potentially hazardous operation.

---

### 4.1 Vibration

The HoverflyOPEN™ utilizes extremely sensitive gyroscopes and accelerometers to monitor the orientation and motion of a multi-rotor aircraft. These sensors will register even the slightest vibration existing in the airframe. Unbalanced or damaged propellers are one of the biggest contributors of unwanted vibration. The special vibration grommets included with the HoverflyOPEN™ should be used at all times. These grommets mechanically de-couple the HoverflyOPEN™ from the airframe substantially. Over tightening the screws holding the HoverflyOPEN™ to the standoffs will negate the beneficial aspects of the grommets. Hand tighten these screws lightly to hold the HoverflyOPEN™ onto the airframe but do not compress the grommets too much.

The HoverCore™ algorithm is smart enough to discount most of the airframe vibrations. This is done so that only the actual rotation and acceleration of the aircraft are utilized. However, every effort should be made to build a solid airframe devoid of vibration.

## 4.2 Configurations

The HoverflyOPEN™ can be configured using the Update Client (see Chapter 6) so that it may be used on several different types of multi-rotor aircraft. The basic configurations are X, +, Hex, Octo, Y6, and X8. All of these configurations are shown in Fig. 5 shown below.

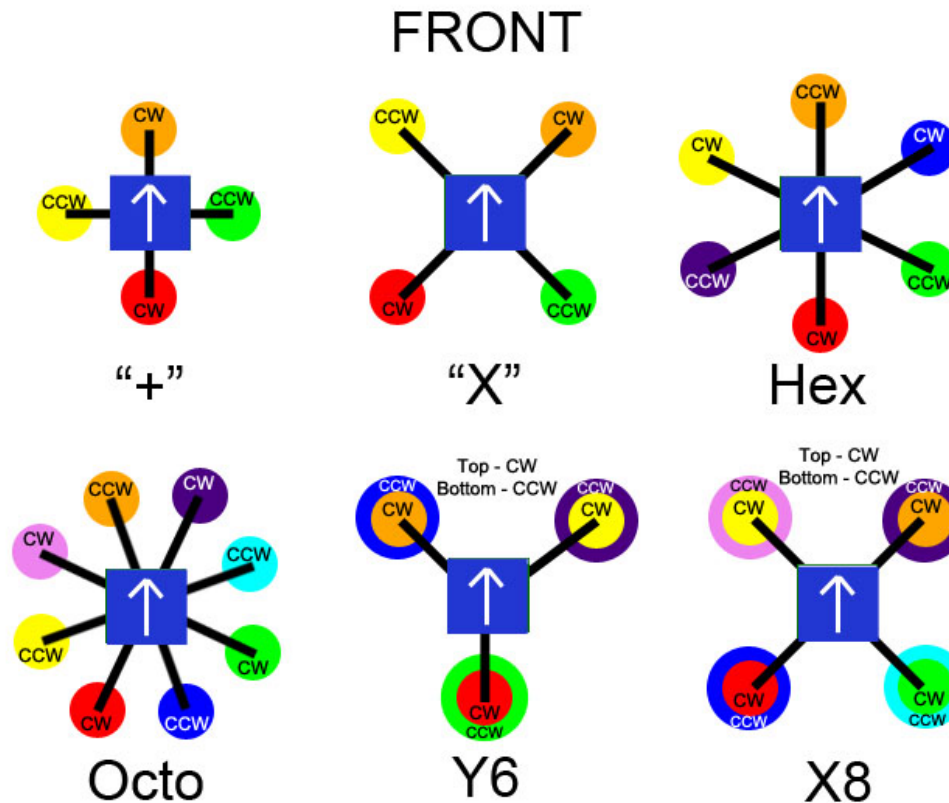

Figure 5. Supported configurations (CW – Clockwise and CCW – Counter Clockwise). Larger disc indicates bottom motor.

## 4.3 Transmitter

The transmitter used to pilot a multi-rotor aircraft but it also controls many of the advanced features of the HoverflyOPEN™. The four main controls are the sticks on the transmitter that control the Roll, Pitch, Yaw, and Throttle (altitude) of the aircraft. These controls are described in Fig. 4. You must use a transmitter that has the capability to program or set the End-Point Adjustment (EPA also called ATV) values for channels separately.

### 4.3.1 Channel Requirement

Flight requires the use of 5 channels. The four main channels are associated with the two control sticks and are used for Roll, Pitch, Yaw, and Throttle. The fifth additional channel is used to control the Gain of the HoverflyOPEN™ control. The Gain is the parameter that is used to tune the performance of your multi-rotor aircraft. This subject is covered in Chapter 5.

Following the manual supplied with your transmitter configure it according to these parameters. Keep in mind that your radio may not have some of the settings listed. In general, the default Acro configuration of most radios is a good starting point. Do not use Heli mode. The following should be set for all channels.





Table 1. Transmitter parameter settings.

Parameter	Setting
End point adjustment	100% for "+" and "-" sides
Dual-Rates (D/R)	100%
Channel Reverse	Normal – HiTec, Spektrum, JR Reversed - Futaba
Trims	Centered
Sub Trims	Centered
Exponential	Suggested to add up to 30% into aileron and elevator

## 4.4 Receiver

The HoverflyOPEN™ automatically senses the signal from which ever brand of Receiver that you choose for your aircraft. The power for your receiver will come from the channel connections to the HoverflyOPEN™. However, the number of channels available on the receiver must be at least 5.



Figure 6. Typical RC Receiver (6-channel Spektrum AR600 is shown).

---

## 4.5 Motor Wiring Harness

### 4.5.1 Proper Soldering (read even if you know how to solder)

The basic motor wiring harness consists of a battery, ESCs, and motors. The ESCs are connected to the HoverflyOPEN™ which is covered in the next section. The high levels of currents required by the motors through the ESCs from the battery require both correct wire diameter (gauge) and good solder joints. A good solder joint is achieved when both wires and the solder joining them are heated to an equal temperature. When the soldering iron is removed the entire joint should be shiny. If is dull and not shiny this is called a cold solder joint and will eventually fail. In addition, high-quality solder should be used at all times. If the solder contains flux the joint should be cleaned with flux remover after soldering. Flux (the black goo) is an acid meant to etch the metal connections to help the solder adhere to its surface. If the flux is left on the connection it will continue to etch the metal and the joint will eventually fail. If you are not a qualified electronics technician then you should search for “soldering techniques” on the internet.

A piece of heat-shrink tubing should be placed on one of the wires before joining them with solder. The length of heat-shrink tubing should be long enough to overlap the joint on both sides by at least 1/2” (~2 cm). Move the heat-shrink tubing as far away from the joint before applying heat. Otherwise it will shrink before you can slide it over the joint. Use a hot air gun or hair dryer to shrink the tubing over the joint. Do not use electrical tape because it will eventually un-wrap itself and can cause catastrophic failure. Do not use wire-nuts high-current joints require a solid connection between the wires.

**More Support:** You can watch a soldering tutorial on our site  
<http://www.youtube.com/watch?v=0aLX81YYQ6o>



## 4.5.2 Current vs. Wire Gauge

Stranded wire should always be used to build your wiring harness. Current actually flows mostly along the surface of a conductor (more so in high frequency AC than DC) and as a result stranded wire can carry more current than solid wire simply because of the greater surface area. This is one reason why battery cables in your car and welding cables are made up of many very fine strands of smaller wire. Copper conductors also have resistance that increases with length. All wires in your system should be kept as short as possible to reduce this resistance. Added length wastes power and your flight times will suffer. For example a 1 foot (~30cm) length of 12 AWG (American Wire Gauge) used at 12V carrying 25A will consume 4 watts of power.

The following table may be used to determine the gauge wire that is used in different parts of your wiring harness. Consult an online AWG vs. length vs. current calculator or reference to assure that the wire you choose is sized safely. After you build and fly your wiring harness run your finger across the entire harness looking for hot spots. If you cannot touch the wire for more than 1-2 seconds then it is at 60-70 degrees Celsius. The insulator (PVC covering) on most wires cannot withstand temperatures greater than 70 degrees Celsius (TW, UF rating). So if you can't touch a wire or solder joint for more than approximately 5 seconds it is liable to fail at some point during operation. Increase the gauge of your wire or re-solder the joint.



Table 2. Wire gauge vs. current carrying capacity (Ampacity).

Copper Wire AWG	Ampacity
18	15
14	30
12	40
10	50
8	70

**Fire Hazard:** Using improperly sized wires can result in a fire. Check your wire harness often for defects and hot spots.

### 4.5.3 Battery Source

One of the most critical parameters of all multi-rotor aircraft is weight. As a result, the standard battery source is Lithium-Ion Polymer (LiPo or LIPO) chemistry batteries because they offer the highest milli-ampere hours (mAh) to weight ratio. These batteries are widely available can come in 2-, 3-, 4-, and 5-cell configurations (denoted as 2S, 3S, 4S, and 5S) offering 7.4V, 11.1V, 14.8V, and 18.5V. Increased flight times can be obtained by placing two batteries in parallel doubling the overall mAh. All of these cell configurations can be used with the HoverflyOPEN™ since it is powered from the BEC incorporated into the ESCs.

You should follow all manufacturers warnings concerning using and charging your batteries. A cell-balancer should always be used on high-capacity LiPo batteries. Do not charge your batteries at a current greater than specified by the manufacturer. Care must also be taken with



respect the maximum discharge current the battery can handle safely. You should buy a watt meter and place it into your wiring harness during testing (don't leave it in place while flying since it will add weight). Measure the maximum current draw from your battery source while the multi-rotor aircraft is mounted to a test bench. Make sure that you are not exceeding the manufacturer's specifications.

**Danger:** Use extreme care when using LiPo batteries they can be extremely dangerous under certain conditions and when damaged.

#### 4.5.4 Electronic Speed Controllers (ESCs)

In this guide, we will limit the information provided to brushless-motors since the use of brushed motors is not commonly seen in recent times. It should also be noted that brushed motors generate a large amount of Electro-Magnetic Pulse noise because of the arcing between the brushes and the contacts on the rotor. Use of brushed motors has not been tested on the HoverflyOPEN and it is recommended that the user NOT use them.

An Electronic Speed Control or Electronic Speed Controller (ESC) is an electronic circuit that has two primary functions. First, the ESC regulates the battery source down to the voltage needed by servos and the RC receiver. Second, the ESC converts the signals from the RC receiver to a brushless motor control output. The regulation is used by your receiver and but is not used by the HoverflyOPEN™. In fact there is no circuit connection between this regulated voltage and the main processing electronics on the HoverflyOPEN™. This is why a separate connection from the battery to the Power input on the HoverflyOPEN™ is required (more on this in following sections).



Figure 7. Typical Electronic Speed Controller (ESC) for brushless motors.

The input signals to the ESC produced by the RC receiver are what are called Pulse-Width-Modulated (PWM) waveforms. The voltage levels of this signal vary in time between the common voltage, thought of as 0 volts, and the RC receiver voltage typically 5 or 6 volts. The PWM signal consists of square pulses separated in time where the width of the pulse corresponds to the commanded position of a servo. A short pulse would drive a servo to its minimum range and a long pulse to the maximum range. When the PWM signal is fed into an ESC the short pulses would signify low throttle (or no throttle) and long pulse to high throttle. The use of throttle here is related to the original use of a servo to literally close and open an air fuel mixture carburetor on a gas engine. For brushless motors, we use low throttle to mean low RPMs and high throttle for high RPMs.

All ESCs operate functionally the same but there are preferred brands that change over time. This information can be found on a forum such as RCgroups.com. However, the size of an ESC refers to the amount of current that it can handle. Each ESC will have an associated current rating and you must carefully design your motor drive system with this in mind. As a general rule, you should always use an ESC with twice the maximum current that you believe will be utilized by the motors. You can match the maximum current to the ESC current rating assuming that the manufacturer also used a safety buffer in the rating. However, we strongly recommend that you over specify your ESCs. If one fails, the aircraft may become unstable if you do not have redundancy built into the system (such as with an X8 configuration).



As part of your field box, you should purchase a watt-meter that also measures current. These simple and fairly inexpensive devices connect in-line with battery and allow you to make a quick measurement of the current draw and wattage used at different throttle settings. A simple calculation of current draw at hover will give you a good idea of what your expected flight times will be. As an example:

Measured Current at Hover = **25 A**

Battery Capacity = **4400 mAh**

Expected flight time =  $4400\text{mAh} / 25\text{A} \times 60\text{ mins/1hour} \times 1\text{A}/1000\text{mA} = 10.56\text{ minutes}$

There are many different ESCs available that are adequate for use with a multi-rotor aircraft. As a result, it is impossible to provide a specific description of the set-up and calibration steps required. The following is a suggested order for set-up and calibration that you should refer to while observing the guide that was supplied with your ESC.

Currently, Turnigy Plush series ESCs available from <http://www.hobbyking.com> work well for multi-rotors. Others may work but users should check RCGroups for the latest information.

**PWM Frequency: The HoverflyOPEN uses PWM output frequencies higher than the standard 50Hz accepted by most ESCs. Therefore there are some brands that do NOT work: Jeti and Scorpion.**





#### 4.5.4.1 ESC Configuration

You will want to use your battery, receiver, and ESC to program the following values. You MUST set-up all ESCs in your system to have equal configurations. Check the ESC manual and compare the following values, they are most likely the default values and you may not need to change them. Start by connecting a single ESC to the throttle channel of the receiver. Then connect the battery to the ESC and use the ESC manual to set the following values using your transmitter. Repeat for each ESC if needed.

Table 3. ESC Configuration Values

Parameter	Setting
Brake	OFF
Battery Type	NiMh (even if you use LiPo)
Cut Off Type	Soft Cut-off
Timing Mode	Medium
Startup Mode	Hard or Fast (NEVER soft)
Governor Mode	OFF (if available)

#### Motor Timing

To cover the most possible scenarios without prior testing, medium timing should be used. Those who wish to use low timing to conserve power should bench test the esc/motor/prop combo prior to flight by running it completely through the throttle range to make sure there are no sync issues that would cause the motor to hesitate or stall. If the motor manufacturer recommends a specific timing (such as high), then that



recommendation should always be followed. Bench testing all timing selections prior to flight and choosing the lowest one that gives smooth motor response throughout entire throttle range should provide the most efficient setup.

#### 4.5.4.2 ESC Calibration

Once again, it is best to follow the instructions in your ESC manual to perform this calibration. However, it is critical that you perform this calibration on ALL of the ESCs in your system. Start by connecting a single ESC to the throttle channel of the receiver. Then connect the battery to the ESC and use the ESC manual to complete the calibration using your transmitter. The following steps are the typical calibration procedure for most ESCs.

##### **Typical ESC Calibration Procedure**

1. Turn on your transmitter.
2. Move the throttle stick to full (all the way up).
3. Connect the battery to the ESC.
4. Your ESC will beep to indicate it is in programming mode (the beep will only be audible when connected to a motor).
5. Once in programming mode, exit programming mode by moving the throttle back to idle (all the way down).
6. Wait for confirmation that programming mode has been exited (usually a series of beeps when connected to a motor).
7. Disconnect your battery and receiver from the ESC.
8. Repeat procedure for each and every ESC in your system.

#### 4.5.5 Connectors

The connections between the wires in your wire harness can be joined in two ways: Soldering or Connectors. The battery connection to the wire harness will have to be made with a connector so that it can be removed for charging. All other connections can be made by soldering the wires together and then covered with heat-shrink tubing as explained in a previous section (4.3.1). However, we do recommend this approach. At some point during the use of your aircraft a major component such as a motor or ESC will need to be replaced. As a trade-off however, connectors are heavier (slightly) than solder joints. We recommend that you use connectors between all major components when you build your first multi-rotor aircraft. This will make life much easier especially when you are going through set-up and discover that a motor direction needs to be reversed. You won't be able to do this with the transmitter but if you use connectors it's a quick fix (more on this later). Experienced users will have their own methodology for the when to use connectors.

Remember that just like the wire gauge you choose the connectors must also be sized correctly. All connectors have an associated current capacity. You should follow the manufacturer's specification when designing your wire harness. When soldering your connectors and covering them with heat-shrink take your time and make sure that two adjacent connectors cannot physically touch conductor-to-conductor. This will result in a short and may lead to failure of the aircraft during flight.

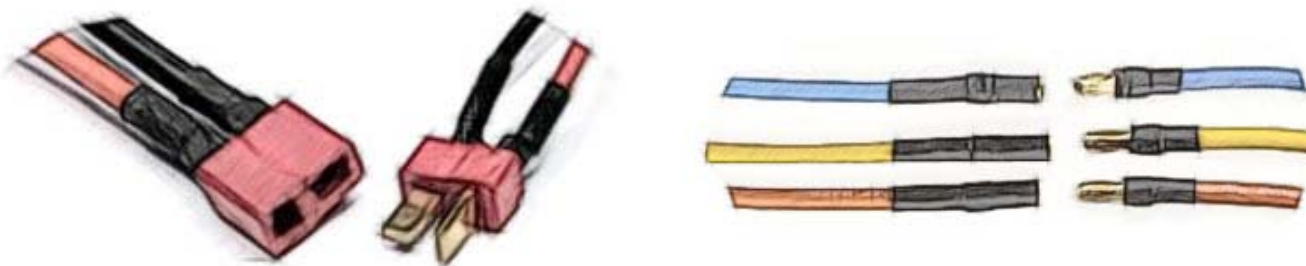

Figure 8. Typical power and brushless motor connectors.



## 4.5.6 Wiring Harness Layout

The wiring harness includes the wire connections from the battery through the ESCs to the motors. The following diagram is a suggested layout for your wiring harness. Use this diagram if you have no experience with building multi-rotor aircraft. Your layout should differ only if you have extensive experience with wiring.

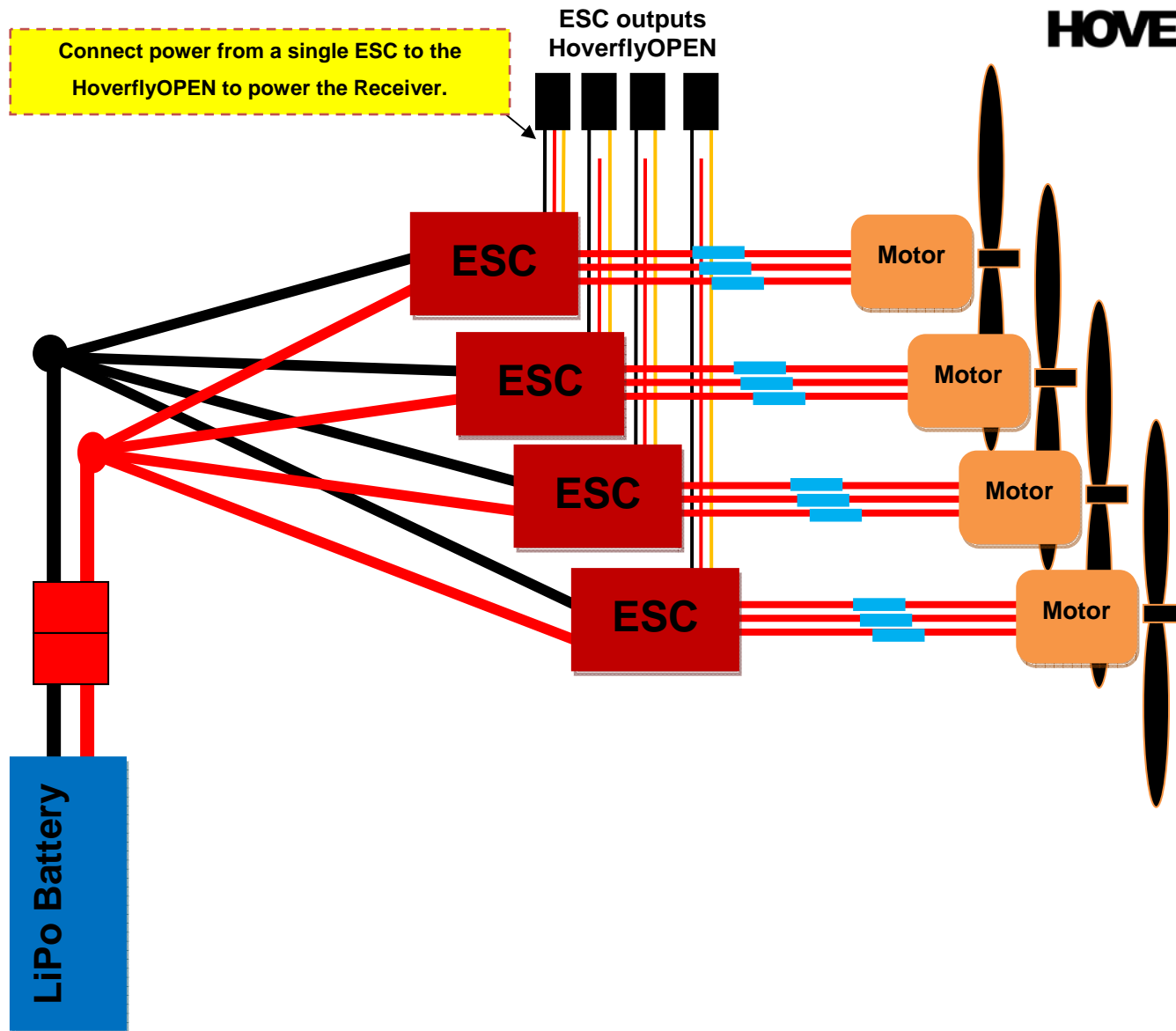

Figure 9. Typical wiring harness layout.



## 4.5.7 Power Filtering

The HoverflyOPEN does not have a separate power connection port. Instead, power is received directly from the output of the ESCs battery elimination circuit (BEC). On board filtering eliminates the need to use any type of external power filtering. When connecting the ESCs to the HoverflyOPEN the user should remove all but one of the power connections on the 3 pin hobby connector as shown in Fig. 9.

---

## 4.6 Airframe

The airframe is the solid structure used to fix the motors into a particular configuration and provide a platform for flight electronics and accessories such as cameras. Frames should be built from materials that lock the motors orientation and position about the HoverflyOPEN™. This guide will not go into great detail about frame construction. Users have built frames from everything from towel rods to molded and machined carbon fiber. You will want to balance rigidity with weight. A fantastically solid frame could be made by welding 1 inch (2.54cm) industrial steel together, but it may not fly because of the weight (it's certainly possible depending on the motors you use it's certainly possible). You will want to keep weight in mind when you are building. In addition, you will want to design your airframe so that you can repair it easily. Everyone crashes eventually so the easier it is to repair the more time you will have in the air.

### 4.6.1 Airframe Vibration Dampening

This chapter started with a discussion concerning vibration (4.1). There are simple things that can be done to reduce airframe vibration. A technique that yields very good results is to mount the arms of the frame to the main hub with dampening material. If the arms are sandwiched between two plates, silicon rubber can be used to between each side of the arm and the hub plates. Another method that works well is to use O-rings as washers when mounting the arms to the hub plate.



## 4.6.2 Stand-offs

The HoverflyOPEN™ should be mounted to the main platform using stand-offs. These are cylindrical aluminum, plastic, or rubber legs that are either threaded or hollow to accept a long mounting screw. The supplied vibration grommets should be used at all times between the HoverflyOPEN™ and the stand-off mounting screws. Do NOT over tighten the mounting screws. You can damage the printed circuit board (PCB) and reduce the performance of the aircraft. Screws should be hand-tightened ONLY until the vibration grommets just begin to compress.

The stand-off length should be kept as short as possible. You will most likely have to fit wires beneath the board so a short 1 inch (2.54cm) stand-off may be used. Longer stand-offs shorter than 2 inches (~5cm) should work fine. However, keep the HoverflyOPEN™ mounted as close to the main plate as possible. Unreasonably long stand-offs will increase vibration and reduce the performance of the HoverflyOPEN™.

---

## 4.7 Brushless Motors

All electric direct current (DC) motors consist of a rotor (rotating element) and a stator (fixed element). On older brushed motors, the coil was mounted on the rotor which is mechanically fixed to the shaft of the motor. This required brushes pushing onto a commutator. The result is low-life time and efficiency. Modern brushless motors eliminate the lossy commutator by mechanically fixing the shaft to the rotor and mounting the coil on the stator. Brushless motors typically have efficiencies greater than 75% (can be as high as 95%) and much longer life-times.

Brushless motors are used almost extensively for multi-rotor aircraft since increased efficiency means longer flight times. In addition, the power to weight ratio is higher because power is not lost from frictional forces of brushes on a commutator.



Brushless motors are rated in  $K_v$  for voltage constant not to be confused with KV for kilo-volts. The  $K_v$  rating of a motor relates to the RPM the motor will spin with 1 volt applied with no load (no propeller). To illustrate this if a motor has a rating of 500  $K_v$ , then it will spin at 500 RPM with no propeller. If a battery with a voltage of 11.1V is used with this motor then it could theoretically achieve 5550 RPMs. However, in reality this is a good rule-of-thumb but an effect called back-EMF may keep the motor from reaching this speed. Every motor has a base-speed that it can operate below that occurs with the back-EMF equals the battery voltage. An exact, RPM can be calculated using an online tool (<http://www.peakeff.com>) or a program like MotoCalc.

The speed of the motor and the size of the propeller will determine the amount of thrust that can be generated. The weight of the multi-rotor aircraft will govern how much thrust is required to hover and move it through the air. In order to specify your motor, propeller, and battery requirements you will need to use a program like MotoCalc.

---

## 4.8 Propellers

Multi-rotor aircraft require the use of an equal number of propeller and motors. In addition, half of the propellers need to spin clockwise and the other half in the counter-clockwise direction also called counter rotating configuration. This means that the pitch must be opposite for different directions. It is recommended that you use 10-12 inch (25.4-30.48 cm) diameter propellers with 3.8-4.5 pitch. There are several brands to choose from but we have found APC to be durable and consistent. One in particular is the APC 12x3.8 SFP Slow Flyer Counter Rotating Propeller.

If you are building a smaller aircraft then some of the GWS tri-blade propellers work well. Unfortunately, at this time there are few choices available on the market.





Each time you place propellers on your aircraft you will want to balance them. Failure to properly balance the propellers will induce unwanted vibration on the airframe and HoverflyOPEN™ and reduce flight performance. Inspect each propeller before each flight. If any damage is detected you should replace the propeller with a new balanced one.

You strongly recommend that you don't use Propeller Savers. Even though it may extend the lifetime of the propeller it will cause rotor flap that generates a strong vibration. You should use aluminum propeller holders that will provide a solid connection between the motor shaft and propeller.

---

## 4.9 Canopy

It is highly recommended that the sensitive and valuable flight control electronics of your aircraft be covered. The user will want to protect the HoverflyOPEN with a hard shell cover or canopy. At some point, the aircraft will have a harder than expected landing. A simple cover will protect the electronics from broken propellers and other foreign object damage (FOD).

---

## 4.10 Connecting the HoverflyOPEN™

Once the airframe is built, motors mounted with propellers, and the wiring harness is installed it is time to mount the HoverflyOPEN™ and connect it to the ESCs and Receiver. This part of the installation can be a bit confusing depending on the number of motors and channels your aircraft requires. This section has been divided into each configuration to make the required connections more clear.

### 4.10.1 HoverflyOPEN Orientation

Two distinct arrows can be seen on the HoverflyOPEN. These indicate the direction of forward movement for your aircraft. The picture below illustrates the correct orientation of the HoverflyOPEN.

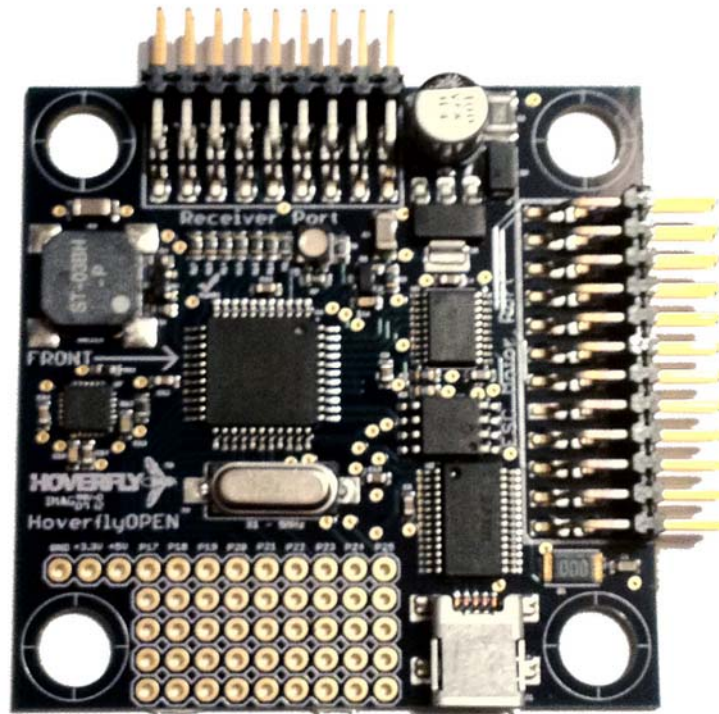

**Forward Flight**



Figure 10. Board orientation.

#### 4.10.2 Receiver Connection to HoverflyOPEN™

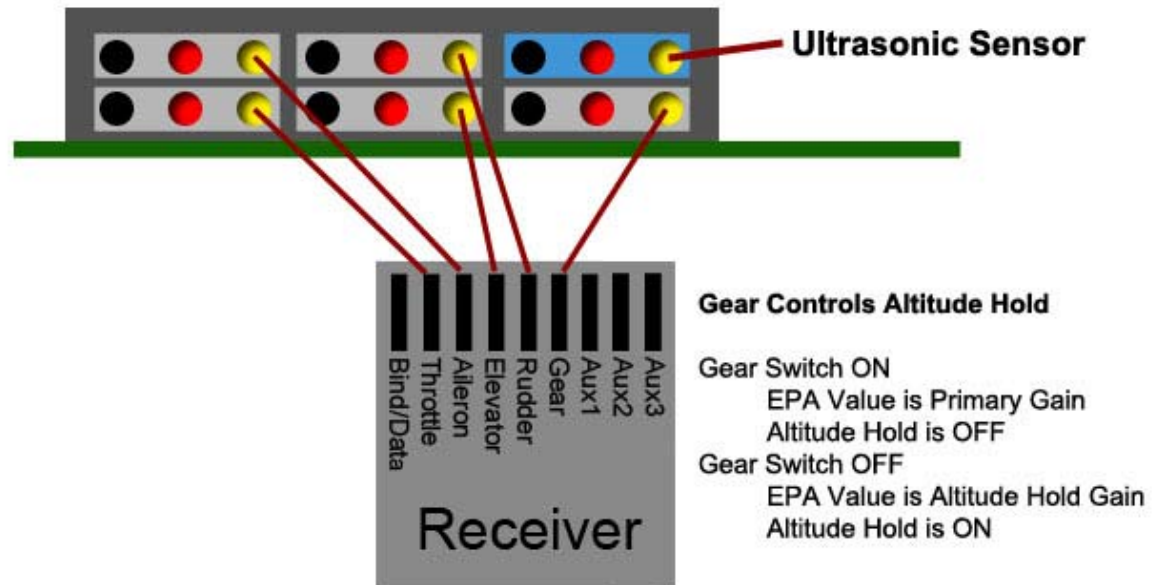
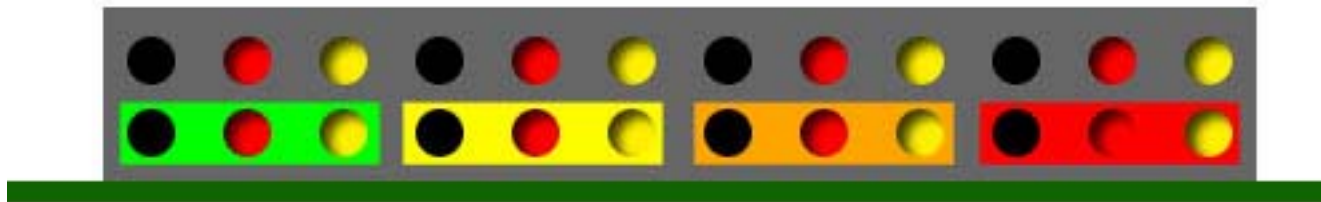
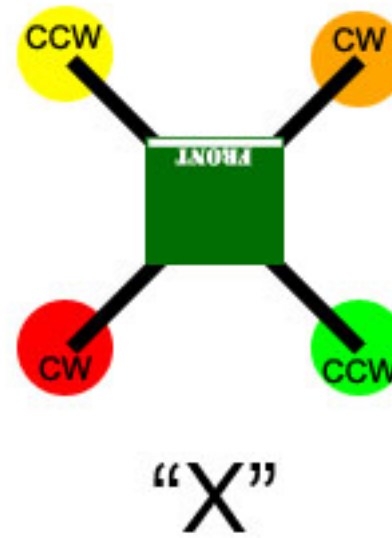
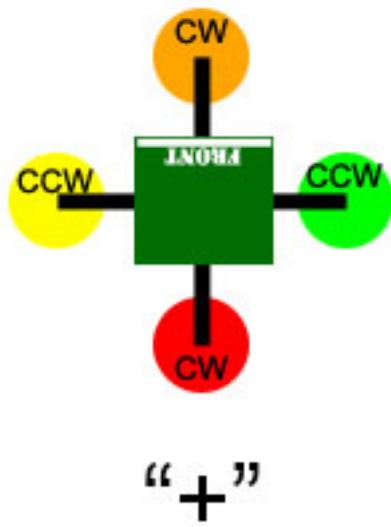

Figure 11. Receiver to HoverflyOPEN connections.

4.10.3 Configurations - “+” and “X”

FRONT



4.10.4 Configurations – Hex and Y6

FRONT

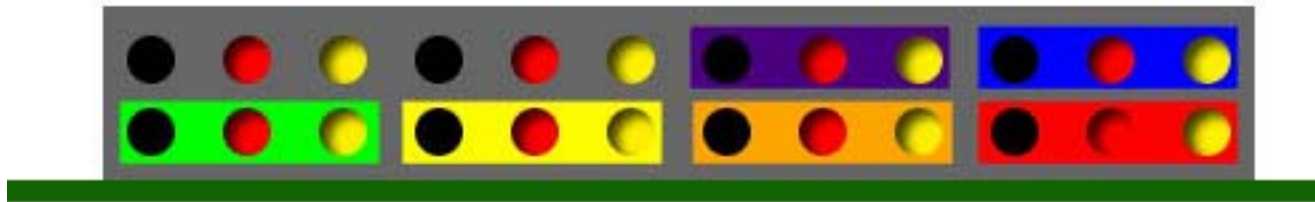
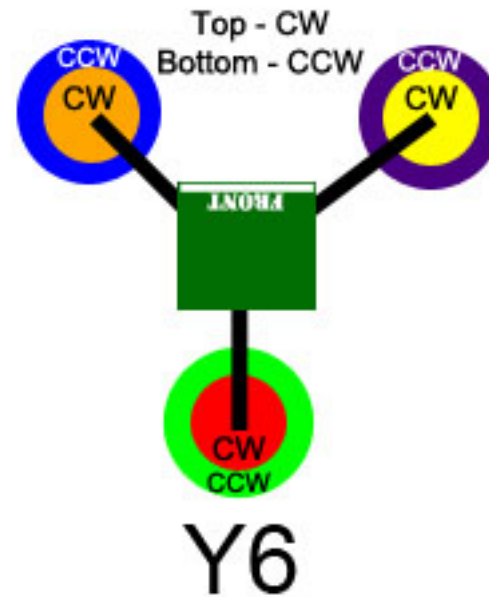
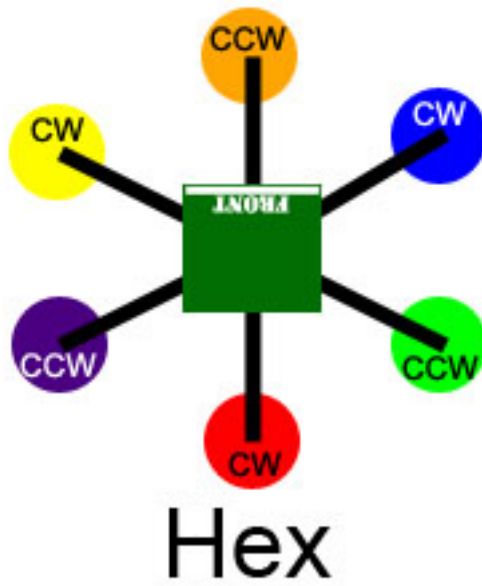

4.10.5 Configurations – Octo and X8

FRONT



Octo

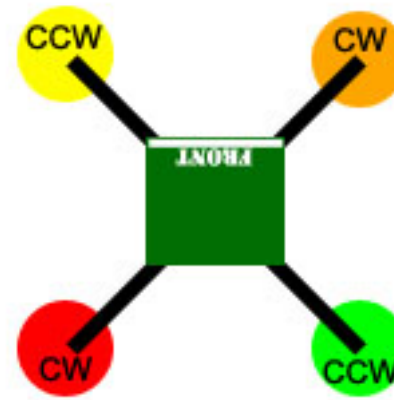

“X”

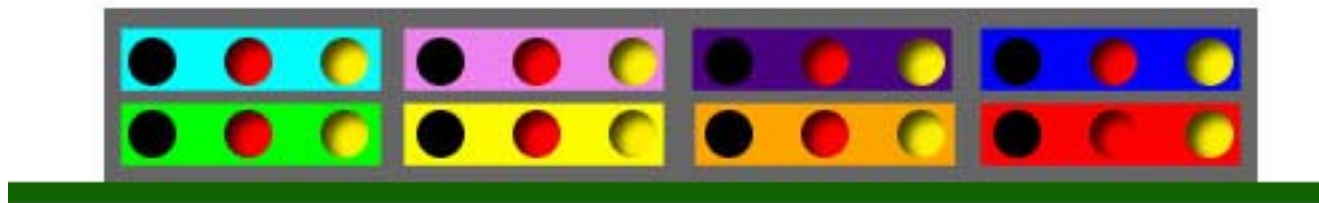

## 5 Operation

In this chapter, operating and flying your multi-rotor aircraft will be described in detail. Before beginning the procedures in this chapter your entire multi-rotor aircraft should be completely built and ready to fly. This includes charging the battery source but not connecting to the wire harness.

---

### 5.1 Before Flight

Before flying your aircraft you should check that all of the following items have been completed:

- ✓ Motors are installed with balanced propellers. Check pitch and rotation for each motor with the corresponding diagram. When the motor is spinning in the indicated direction (CW or CCW) the pitch should direct the thrust downward.
- ✓ None of the connectors are shorting to each other or the frame (if made from conducting material).
- ✓ All wires are secured so that they cannot move into the spinning propellers.
- ✓ None of the propellers are damaged.
- ✓ Each of the ESCs are programmed and calibrated correctly (see previous chapter for settings).
- ✓ All HoverflyOPEN™ connections to the ESCs and Receiver have been made correctly.
- ✓ The latest HoverflyOPEN™ firmware is loaded (see Chapter 6).
- ✓ The transmitter is programmed and set to the correct model.
- ✓ The testing area is clear of anything that could fly up and damage the aircraft.
- ✓ You follow all flying protocol such as airport locality, no power lines, no children, etc.

## 5.2 Setting Gains

The Primary Gain for the HoverCore™ flight stability algorithm is set by the End-Point Adjustment (EPA) value on channel 5. This channel should be associated with a two-position switch. This channel is also used to activate the Altitude Hold mode. You need to adjust the EPA on the “+” and “-” sides of the channel travel.

The value on the right side is typically the “DOWN” position of the Gear switch on Spektrum transmitters also considered the “OFF” position. The EPA travel value is used by the HoverflyOPEN as the Primary Gain value for the aircraft. Moving the switch to the “UP” position or “ON” will allow the left side value to be adjusted. Use a negative value on the left side so that the HoverflyOPEN will read the value correctly. The EPA travel value on the left side is used by the HoverflyOPEN for Altitude Hold Gain.

During flight the Altitude Hold function is enabled using the Gear switch. Moved to the UP or ON position will activate Altitude Hold and the LED will change to a blue color.

### Gear switch activates Altitude Hold

	Altitude Hold Gain Value	Primary Gain Value
[CTRL ADJ.]		
THRO L100% R100%	GEAR -25%	+25%
AILE L100% R100%	FLAP U100% D100%	
ELEV D100% U100%	AUX2 +100% -100%	
RUDD L100% R100%	AUX3 +100% -100%	
	AUX4 +100% -100%	

**Check Setup:** The user should check for proper configuration using the Hoverfly Setup Utility.

Figure 12. Example transmitter programming for EPA (JR9303 shown).





## Tuning Gain

The Primary Gain value is the EPA value that you can edit on your transmitter when the Gear switch is set to Altitude Hold disabled. The Primary Gain value is used by the HoverflyOPEN to increase the sensitivity of the control algorithm. In general a value that is too low would make the controls feel “mushy” and the aircraft would be difficult to fly. A value that is too high would result in quick oscillations of the aircraft and once again it would be difficult to fly. Every aircraft will have a slightly different gain and the user must adjust the Primary Gain to find the “sweet spot” where it feels best for their type of flying.

Begin tuning the Primary Gain starting with a low value of gain around +10 to +25 (as shown in Fig. 12). With the aircraft on the ground and armed increase the throttle until it just lifts off. If it is difficult to control or mushy increase the gain by +10 and repeat the procedure. Once you can safely lift off and hover observe the aircraft and look for oscillations. This is very similar to a remote gain on a helicopter where too high of gain will result in tail twitching. The Primary Gain should be increased to a value just before the oscillations begin.

Once you become more experienced flying with the HoverflyOPEN, you will be able to adjust your gain using the Gear EPA for Primary Gain during flight.

---

## 5.3 Arming the HoverflyOPEN™

In order to use the HoverflyOPEN™ and your aircraft you will have to connect the battery and arm the system. This should be done in the Bench Testing procedure after the aircraft is mounted to a test bench. The procedure will be described here so that you are familiar with it before starting your bench tests.

## Arming Procedure

1. Move your throttle stick to idle
2. Connect the battery source.
3. The ESCs should initialize within 5-10 seconds and beep according to the ESC manual.
4. The HoverflyOPEN will beep 2 times and flash it's LED light green when it is ready to be armed
5. To Arm the HoverflyOPEN™ and aircraft, move the throttle stick to the left-bottom until you hear one beep.
6. Move the throttle stick to the right-bottom you should hear two beeps. The HoverflyOPEN's LED will blink RED During this period the HoverflyOPEN is calibrating it's internal sensors and should remain motionless. (do not arm while holding the aircraft).
7. When arming is complete, the HoverflyOPEN will Beep 3 times.
8. At this time the LED light will turn solid green. The HoverflyOPEN™ is now armed and the aircraft is ready to fly.
9. If the Hoverfly's LED light turns Purple at any point during the arming sequence, ensure altitude hold is disabled and the aircraft remains motionless while arming. Repeat the arming sequence.

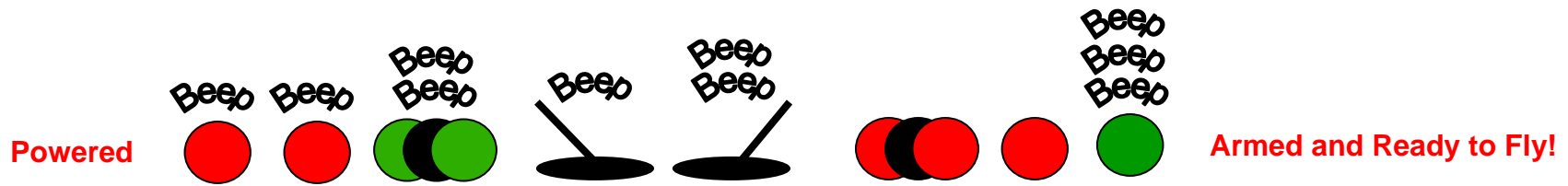

## Disarming Procedure

1. Move your throttle stick to idle.
2. Move throttle stick to left-bottom until you hear one beep.
3. Move throttle stick to right-bottom until you hear two beeps.
4. HoverflyOPEN is disarmed.

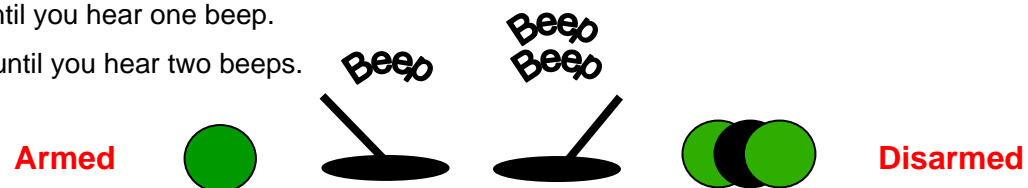

### Trouble Mode

Trouble mode is activated when one of the 5 required channels is not detected (Throttle, Elevator, Aileron, Rudder, Gain).

- Check Receiver connections and binding.
- Disconnect and re-connect power and repeat Arming procedure.

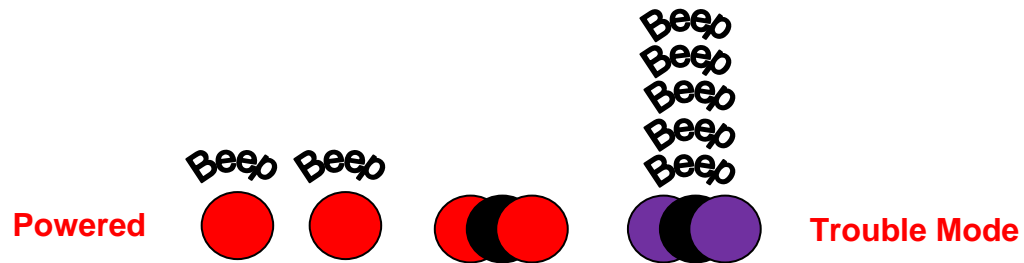

### Gyro Calibration Failure

The HoverflyOPEN performs a Gyro Calibration after power-up. If this calibration fails the LED will respond with a particular blinking sequence that is shown below.

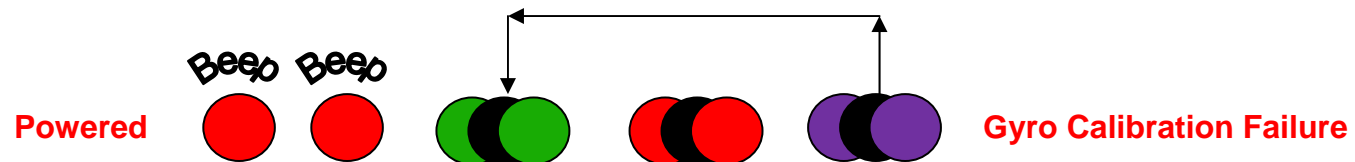

## Altitude Hold Enabled When Arming

The HoverflyOPEN cannot Arm when the Altitude Hold is enabled on power-up. You must disable Altitude Hold using the Gear switch in the “off” position and repeat the Arming process. The following LED sequence will be shown if Altitude Hold is enabled during the Arming process.



---

## 5.4 Bench Testing

Before taking your aircraft to the field you will want to completely check its operation. It is recommended that you mount the aircraft to a sturdy test bench. The mounting should be sturdy enough that at full power the aircraft will not free itself from the bench. Make sure that when the motors are rotating that there are not objects that will fly up and damage the aircraft or propellers.

The first thing that you will want to verify is that the rotation of all of the propellers is correct. Start by connecting the battery source and Arming the HoverflyOPEN™. Refer to the diagrams corresponding to your configuration (i.e., X, Hex, Y6, etc). Start by increasing the throttle stick slightly just until the propellers begin to spin. The thrust for all motors should be directed downward. If any of the motors are spinning in the incorrect direction simply switch two of the three motor wires. Once you are absolutely sure that all motors are rotating and producing thrust in the correct direction you can move to a field for flight testing.

## 5.5 Flight Controls

The basic flight controls for Roll, Pitch, Yaw, and Throttle have been shown previously in this guide but the control diagram is repeated here.

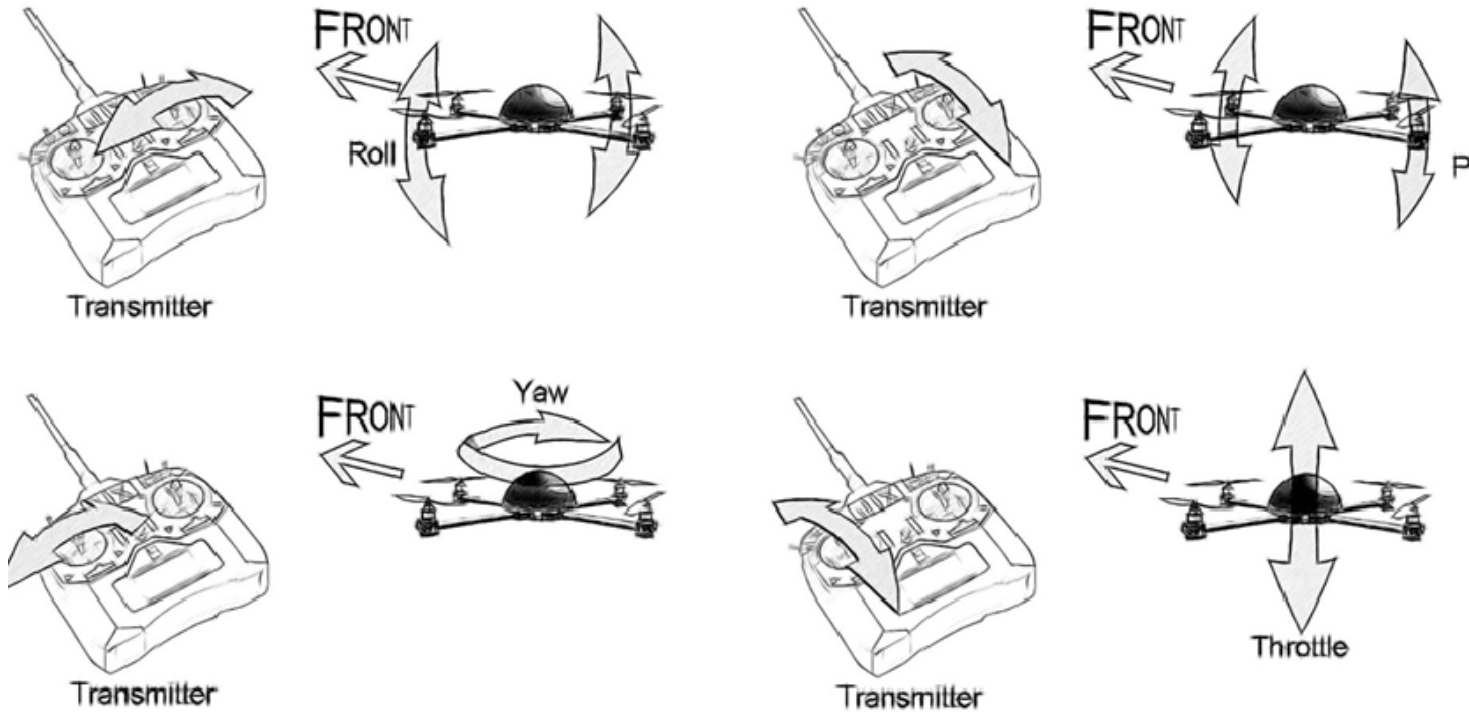

Figure 13. Control stick movement and aircraft roll, pitch, yaw, and throttle (altitude).

---

## 5.6 Basic Flight Mode

In Basic Flight Mode, the pilot will have normal Roll, Pitch, Yaw and Throttle control of the aircraft. The pilot should always start with this mode until the flight characteristics of the aircraft are understood.

---

## 5.7 Advanced Flight Mode

The difference between Basic and Advanced Flight Mode is the use of the Altitude Hold. These are explained in more detail here.

### 5.7.1 Altitude Hold Function

In order for Altitude Hold to be enabled you must have already associated a fifth channel with a two-position switch (as described in 5.2). The Altitude Hold Gain must have also been set to a starting value of - 25%. In addition, you must purchase a separate off-board ultrasonic sensor and attached it to the Receiver Port (see 4.10.2). The user will need to solder a standard 3-pin servo connector onto the ultrasonic sensor as shown below.

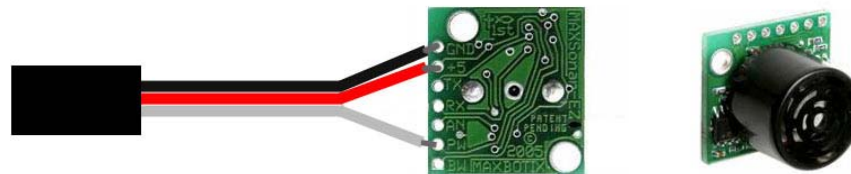

Figure 14. LV-MaxSonar-EZ0 and Connection Diagram  
[http://www.maxbotix.com/MB1000\\_\\_LV-MaxSonar-EZ0.html](http://www.maxbotix.com/MB1000__LV-MaxSonar-EZ0.html)



The Altitude Hold Gain is used by the altitude hold control algorithm based on the ultrasonic sensor. The user should mount the sensor so that it is pointing towards the ground and is not impeded by any wires or landing gear structures. Ultrasonic sensors have a wide beam width and a simple dangling wire within the beam can cause a huge error.

To use the Altitude Hold Function, rise to a safe altitude that you would like the aircraft to maintain. Then activate the Altitude Hold Function by turning the associated switch to on or enabled (position is user dependent). The aircraft will rise and fall within a range of altitude around the chosen altitude. The pilot can increase or decrease the Altitude Hold Gain to increase or decrease the range of altitudes. The accuracy of Altitude Hold depends on sensor configuration (hardware positioning), sensing surface, and other conditions. Typical operation is within a few centimeters.

### **Adjusting Altitude while in Altitude Hold Mode**

While Altitude Hold is enabled the throttle channel no longer adjusts the throttle level directly. Instead the throttle stick controls the altitude based on the ultrasonic sensor. The user can change the altitude simply by increasing or decreasing the throttle.

## 6 Update Client and Setup Utility

The Hoverfly Technologies Update Client is used to load the most current firmware onto the HoverflyOPEN™ and future add-on boards. The Update Client requires a PC running Windows XP/Vista/7 (Mac OS not currently available). Download the latest version of the Update Client from

[http://www.hoverflytech.com/Software\\_Updates.html](http://www.hoverflytech.com/Software_Updates.html)

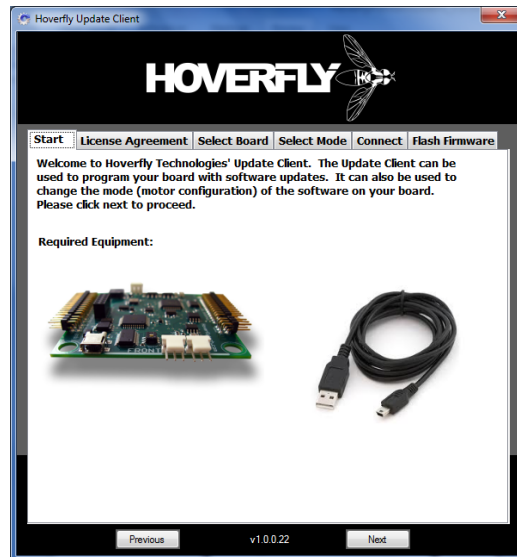

Update Client

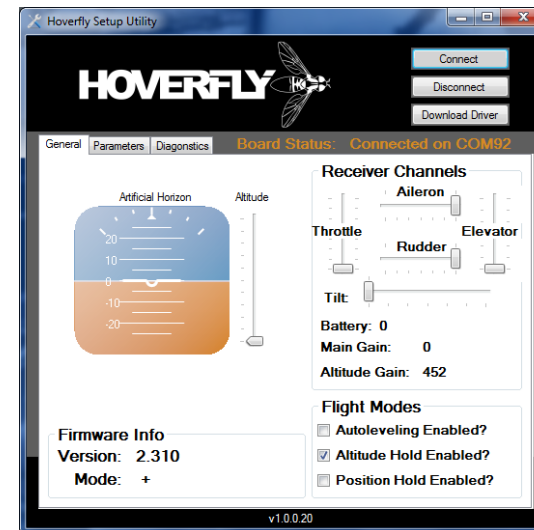

Setup Utility



## 6.1 Firmware Updates

To use the software, simply connect the HoverflyOPEN™ via the supplied USB cable to the computer. Follow the instructions for programming included in the Update Client software.

### 6.1.1 Update Procedure

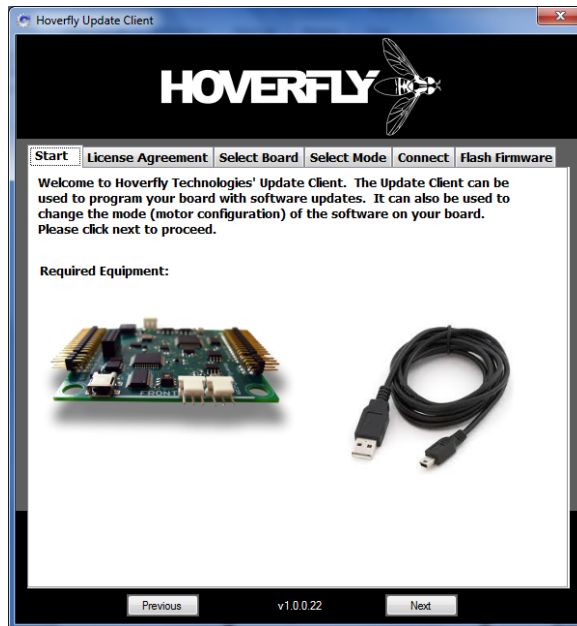

Download and run the Update Client

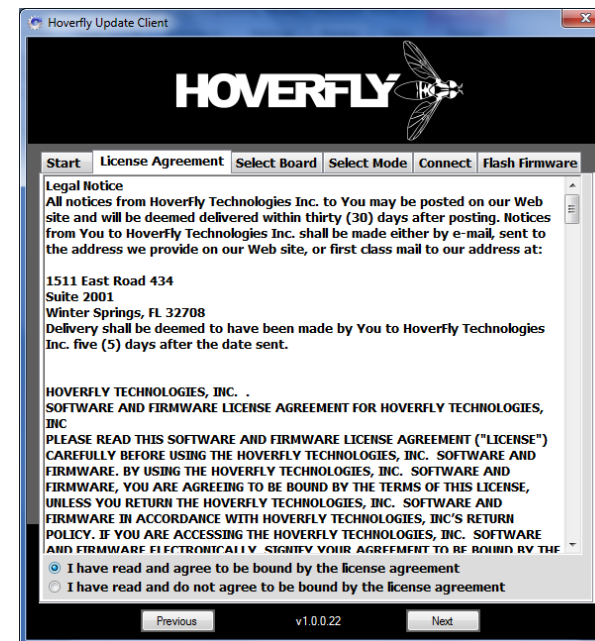

Agree to License Agreement

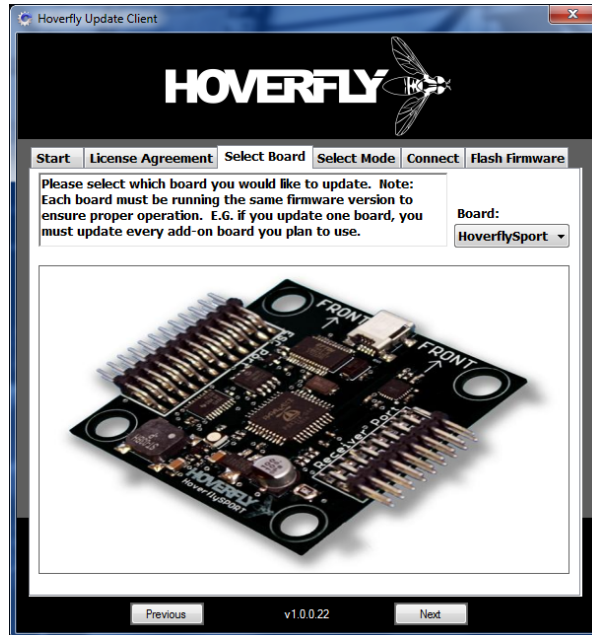

Select the HoverflyOPEN (HoverflySPORT shown)

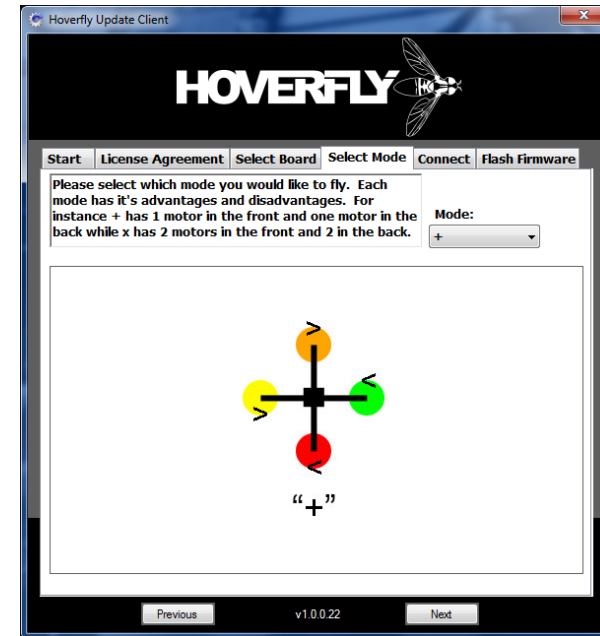

Select Aircraft Configuration



Wait for board to Connect. Use Download Driver only if board will not connect.

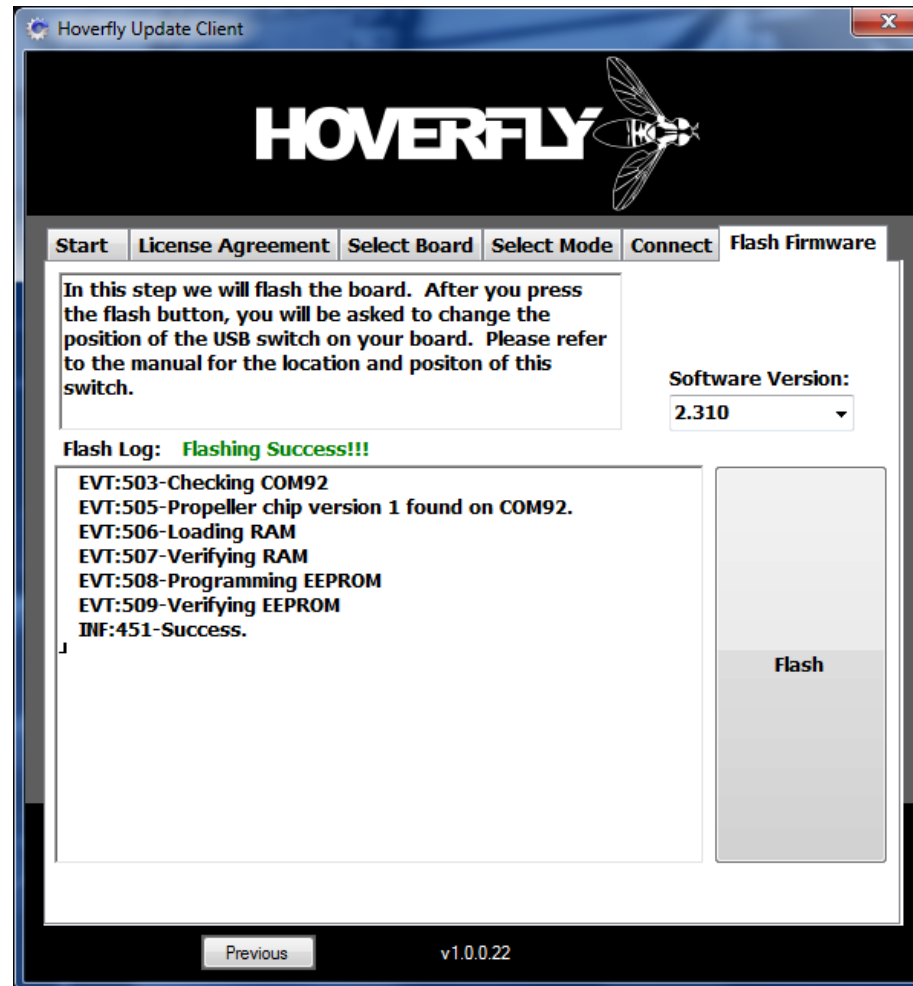

Select desired Software Version and press the “Flash” button.

## 6.2 Setup Utility

The Setup Utility is one of the functions available to the user using the Update Client software. This will enable the user to visually verify the operational status of the HoverflyOPEN™. The user should use this utility to determine if control sticks and switches are configured correctly. For example when the user enables the Altitude Hold Function the Flight Mode will show a check box next to this feature. The user must place the HoverflyOPEN into diagnostics mode before the setup client can connect. The HoverflyOPEN will enter diagnostics mode if the Throttle, Aileron, Elevator, or rudder channels are not connected. The easiest way to reach diagnostics mode is to simply plug the USB cable into your HoverflyOPEN without plugging in your main battery. This way your receiver will not receive power and the HoverflyOPEN will automatically enter diagnostics mode on start up.

### 6.2.1 General Tab

Once the HoverflyOPEN Setup Utility is installed and the board is connected via USB you will see real-time feedback on the operation of the HoverflyOPEN. Understand that the buttons and sliders are not user adjustable, they are only a visual display of current values. When the board or aircraft (if it is already installed) is moved (Roll, Pitch, and Yaw) the Gyro and Accelerometer values will change. When the receiver and transmitter are turned on, the Receiver Channel sliders will show the current positions of the control sticks. Additional information such as firmware version, gains, and battery voltage are also displayed. Understand that the Gain values may not correspond exactly to the EPA values on your transmitter.

The user can also flip the Altitude Hold switches on the transmitter. The detected position and corresponding function will be shown on the Setup Utility under Flight Modes.

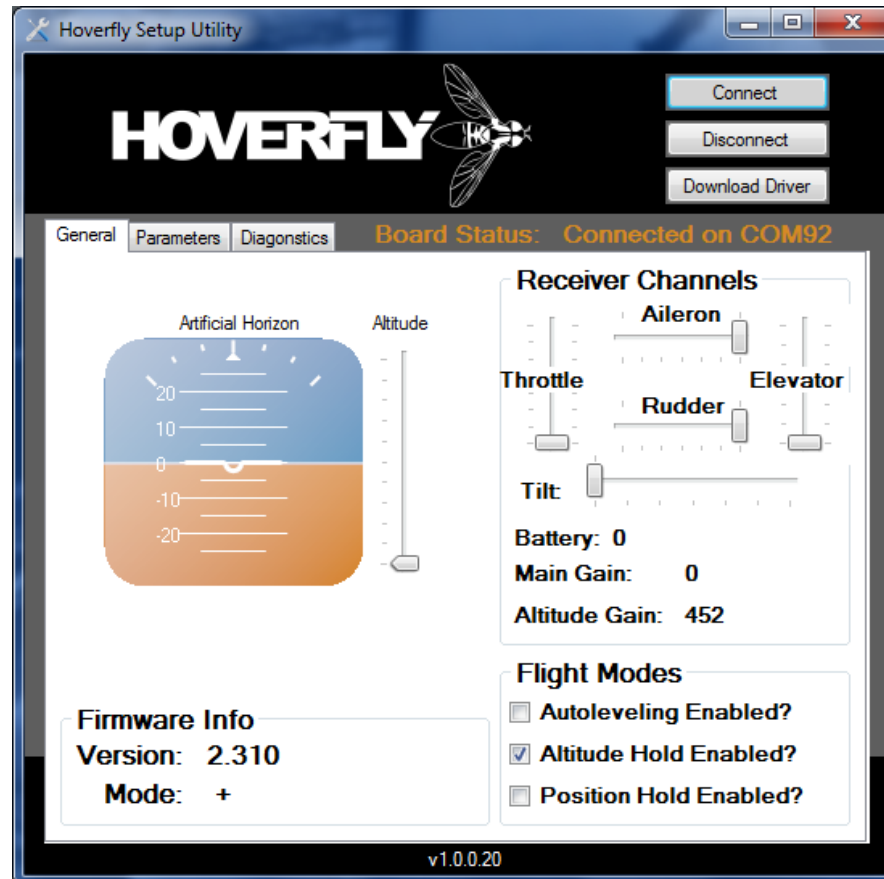

Screen shot of Setup Utility



## 6.2.2 Parameters Tab

The parameters tab is for use with the HoverflyPRO only.

## 6.2.3 Diagnostics Tab

The Diagnostics Tab will allow you to test your HoverflyOPEN for proper operation. Pressing the Test button will provide the user with instructions on how to test the flight controller. Results of the tests will be displayed by the check boxes.

The Flight Log Save button will allow the user to download a flight log from a previous flight saved into the on-board memory. This may be required if you have a problem during flight by the Technical Support Team at Hoverfly Technologies.

## 7 The Open Stuff

The HoverflyOPEN utilizes the amazing multi-core microcontroller made by Parallax, Inc. called the Propeller. We base all of our products on the Propeller because we have come to love the development environment, Spin, and the power of parallel processing. If you don't have it downloaded already you will need the Propeller/Spin Tool Software (<http://www.parallax.com/tabid/832/Default.aspx#Software>). Once you have it installed you can connect to the HoverflyOPEN using a USB mini cable. Now you need a few details about the electronic connections and specifications used. The HoverflyOPEN schematic can be found in Appendix E and the rest of the details are provided in this chapter.

### 7.1.1 Power

The HoverflyOPEN utilizes either the power from the USB port on your computer or power from the Battery-Elimination-Circuit (BEC) incorporated into the ESCs. **DO NOT CONNECT your computer and the aircraft battery at the same time.**

### 7.1.2 3-Axis Digital Gyroscope

The HoverflyOPEN includes one of the best gyroscopes available, the Invensense ITG-3200. What makes this gyro special is the fact that it is all digital (older gyros used analog outputs) and you will only need three connections to get all the 16-bit data. The communication protocol used by the ITG-3200 is I2C and includes the needed pullup resistors onboard. The orientation of the gyro on the board is with "+Y" towards the front of the aircraft. The other axes are shown in Fig. 15.



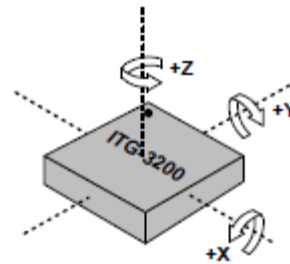

**Orientation of Axes of Sensitivity  
and Polarity of Rotation**

Figure 15 – Axes of ITG-3200 with +Y pointing towards front of aircraft.

Complete details of using the ITG-3200 can be found in the manufacturer's specification sheet  
<http://invensense.com/mems/gyro/itg3200.html>.



### 7.1.3 HoverflyOPEN Pinout Description

Peripheral	Propeller P-Pin
ITG-3200 SCL	P16
ITG-3200 SDA	P 15
ITG-3200 INT	P 14
Red LED	P 5
Green LED	P 6
Blue LED	P 4
Receiver Throttle	P 9
Receiver Aileron	P 8
Receiver Elevator	P 10
Receiver Rudder	P 11
Receiver Gain	P 13
Ultrasonic	P 12
Red Motor	P 2
Orange Motor	P 3
Yellow Motor	P 26
Green Motor	P 27
Blue Motor	P 1
Indigo Motor	P 0
Violet Motor	P 31
Cyan Motor	P 30
Buzzer	P 7
Proto Pins	P17-P25, +5V, 3.3V

Note: +5V on proto area is after power filtering and will be slightly lower.

## Appendix A – Physical Dimensions

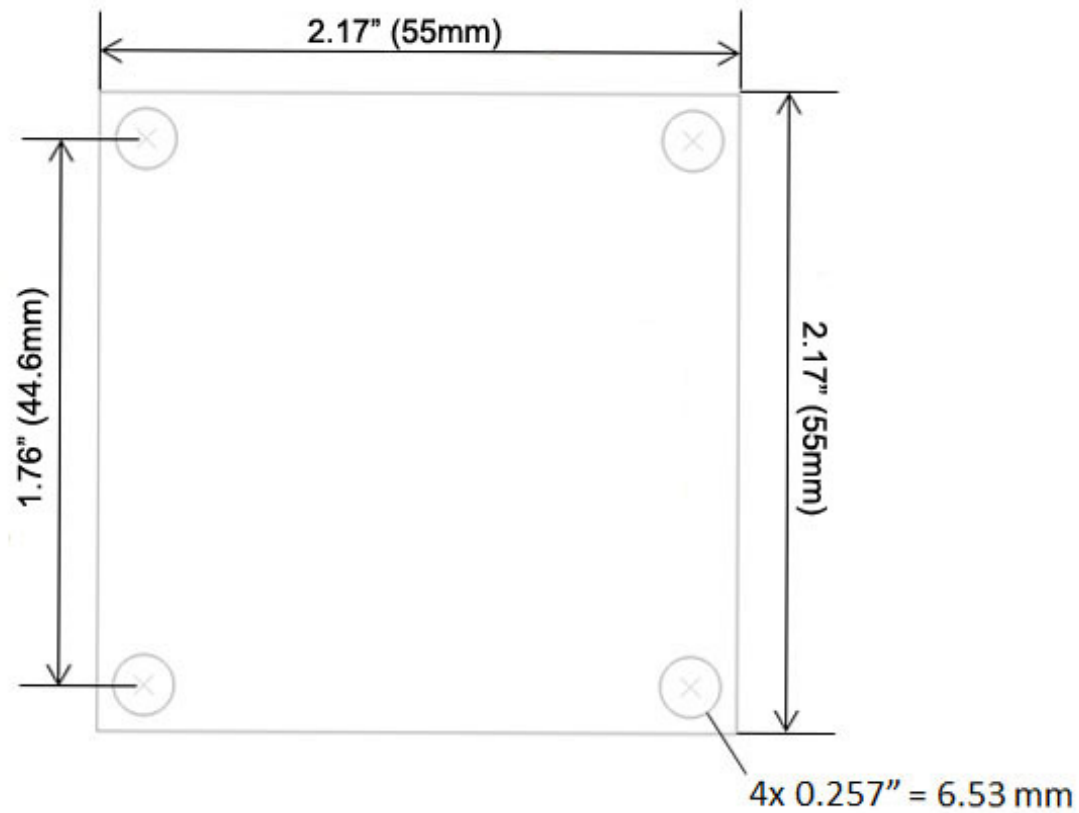

## Appendix B - Technical Specifications

Parameter	Supported Values
Battery Source Voltage	Not Applicable (Powered from ESCs)
ESC output signal	PWM (greater than standard 50Hz)
Receiver Input Signal	PWM (all receivers)
Current consumption	<100mA
PC Connection	USB
Update Client Operating System	Windows XP/Vista/7
Mounting	Standoffs with vibration grommets
Water resistance	None
ESD requirement	User should use appropriate ESD protection

## Appendix C - Quick Start Guide

# 1

### Installation

1. Build and install a single wiring harness connecting the Motors and ESCs.
2. Connect ESCs and Receiver to HoverflyOPEN using corresponding connection diagram.
3. Mount the HoverflyOPEN using stand-offs and the supplied vibration grommets.
4. Fit a canopy to protect the flight electronics.
5. Update to latest firmware using Update Client.

# 2

### ESC Programming

Use the ESC manual and set the following

- Brake - OFF
- Battery Type - NIMH (even when using LiPo)
- Cut-Off Type - SOFT CUTOFF
- Cut-Off Voltage - LOW
- Timing Mode - AUTO or Medium
- Startup Mode - HARD or FAST
- Governor Mode - OFF

# 3

### ESC Calibration

Follow the ESCs manual and calibrate ALL ESCs

# 4

### Transmitter Programming

1. Use the transmitter manual
2. Use a new Acro (airplane) model or set one to factory default settings.
3. Set End-Point Adjustments to 100% (+ and -) for Roll, Pitch, Yaw, and Throttle.
4. Set Channel Reverse to normal (reverse all on Futaba).
5. Center all Trims and Sub-Trims.
6. Turn-off Expo until confident with flight.
7. Set att Dual-Rates to 100%.
8. Set GEAR Primary Gain to + 25% on fifth channel by adjusting EPA.
9. When using Altitude Hold set GEAR Gain to - 25%.

# 5

### Check Operation

1. Use the Setup Utility feature of the Update Client Software to verify all channels and sensor operation.
2. Mount aircraft to test bench.
3. ARM using procedure in User's Guide
4. Check ALL motor rotations and confirm thrust is down.

# Fly!

**We recommend reading the complete User's Guide available at [www.hoverflytech.com](http://www.hoverflytech.com)**

## Appendix D - Connection Reference

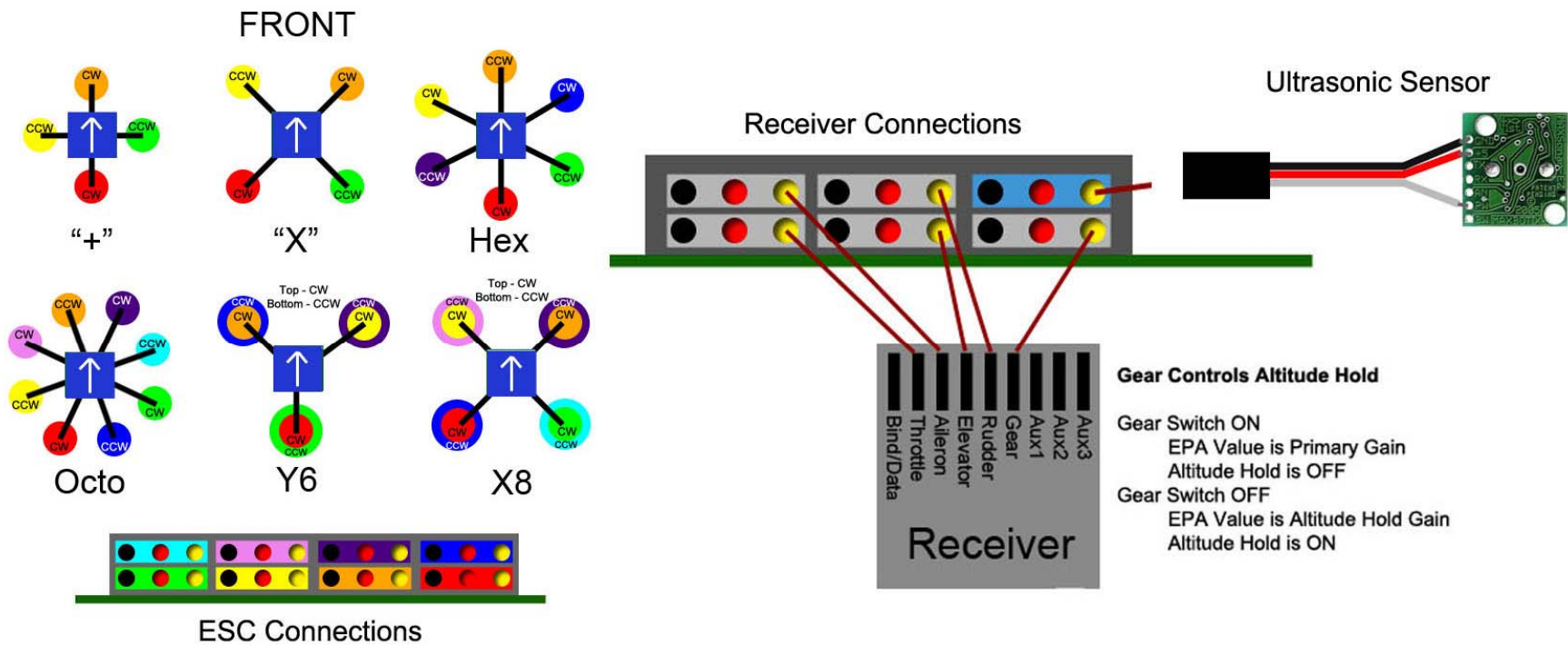

# Appendix E – Schematic

