

# OSRAM OSTAR - Projection

## Lead (Pb) Free Product - RoHS Compliant

LE A G3W, LE T G3W, LE B G3W

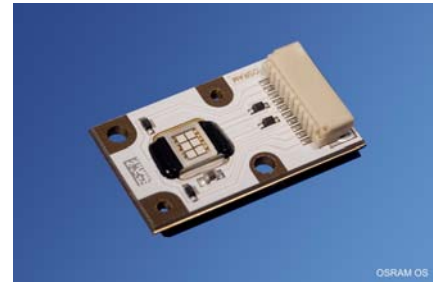

### Vorläufige Daten / Preliminary Data

#### Besondere Merkmale

- **Gehäusetypp:** Kompakte Lichtquelle in Multi-Chip on Board Technologie mit Glasabdeckung
- **Besonderheit des Bauteils:** extrem hohe Helligkeit und Leuchtdichte dank Oberflächenemission und niedrigem  $R_{th}$  Vorbereitet für den Einsatz mit zus. Optik
- **Wellenlänge:** 617 nm (amber); 520 nm (true green); 464 nm (blue)
- **Abstrahlwinkel:** Lambertischer Strahler (120°)
- **Abstrahlende Fläche:** typ. 3,2 x 2,1 mm<sup>2</sup>
- **Technologie:** Thinfilm InGaAlP; ThinGaN
- **Leuchtdichte:** 26\*10<sup>6</sup> cd/m<sup>2</sup> (amber); 41\*10<sup>6</sup> cd/m<sup>2</sup> (true green); 9\*10<sup>6</sup> cd/m<sup>2</sup> (blue)
- **Montierbarkeit:** verschraubbar
- **Stecker:** 10 Pin JST SM 10B-SRSS-TB
- **ESD-Festigkeit:** ESD-sicher bis 2 kV nach JESD22-A114-D
- **Verpackungseinheit:** 50 St. pro Box = Verpackungseinheit
- **Erweiterte Korrosionsfestigkeit:** Details siehe Seite 14

#### Anwendungen

- Projektion
- Medizintechnik: Operationslampen
- Strahler für die Allgemeinbeleuchtung

#### Features

- **package:** compact lightsource in multi chip on board technology with glass window on top
- **feature of the device:** outstanding brightness and luminance due to pure surface emission and low  $R_{th}$  prepared for additional optics
- **wavelength:** 617 nm (amber); 520 nm (true green); 464 nm (blue)
- **viewing angle:** Lambertian Emitter (120°)
- light emitting surface: typ. 3.2 x 2.1 mm<sup>2</sup>
- **technology:** Thinfilm InGaAlP; ThinGaN
- **Luminance:** 26\*10<sup>6</sup> cd/m<sup>2</sup> (amber); 41\*10<sup>6</sup> cd/m<sup>2</sup> (true green); 9\*10<sup>6</sup> cd/m<sup>2</sup> (blue)
- **mounting methods:** screw holes
- **connector:** 10 Pin JST SM 10B-SRSS-TB
- **ESD-withstand voltage:** up to 2 kV acc. to JESD22-A114-D
- **method of packing:** 50 pcs. per tray = packing unit
- **Superior Corrosion Robustness:** details see page 14

#### Applications

- projection
- medical lighting: surgery light
- spotlights

**Bestellinformation**  
**Ordering Information**

Typ Type	Emissionsfarbe Color of Emission	Lichstärke <sup>1)</sup> Seite 19 Luminous Intensity <sup>1)</sup> page 19 $I_F = 1 A$ $I_V (cd)$	Lichtfluss <sup>2)</sup> Seite 19 Luminous Flux <sup>2)</sup> page 19 $I_F = 1 A$ $\Phi_V (lm)$
LE A G3W-LAMA-34	amber	112 ...224	465 typ.
LE T G3W-MANA-25	true green	180 ...355	735 typ.
LE B G3W-JAKA-23	blue	45 ... 90	168 typ.

**Bestellinformation**  
**Ordering Information**

Typ Type	Bestellnummer Ordering Code
LE A G3W-LAMA-34	Q65110A7698
LE T G3W-MANA-25	Q65110A7703
LE B G3W-JAKA-23	Q65110A7701
LE_ACC_SHR_10V_SR	Q65110A4679 (Connector)*

Anm.: Die oben genannten Typbezeichnungen umfassen die bestellbaren Selektionen. Diese bestehen aus einer Helligkeitsgruppe. Es wird nur eine einzige Helligkeitsgruppe und Farbgruppe pro Verpackungsbox geliefert.

\* Zum Zweck der Bemusterung kann in kleinen Stückzahlen der konfektionierte JST-Gegenstecker mit Kabel angefordert werden.

Note: The above Type Numbers represent the order groups which includes only one brightness group per color and tray. Only one group will be shipped on each tray.

\*In small amounts for the purpose of sampling the corresponding connector assembled with cable can be ordered.

**Grenzwerte**  
**Maximum Ratings**

Bezeichnung Parameter	Symbol Symbol	Werte Values			Einheit Unit
		amber	true green	blue	
Betriebstemperatur* Operating temperature range*	$T_{\text{board, op}}$	- 40 ... + 85			°C
Lagertemperatur Storage temperature range	$T_{\text{board, stg}}$	- 40 ... + 85			°C
Sperrschichttemperatur Junction temperature	$T_j$	125			°C
Durchlassstrom pro Chip DC Forward current per chip DC ( $T_{\text{board}}=25^\circ\text{C}$ )	$I_F$	1000			mA
Stoßstrom pro Chip DC Surge current per chip DC $t \leq 10 \mu\text{s}$ , $D = 0.1$ ; $T_A=25^\circ\text{C}$	$I_{FM}$	2000			mA
Sperrspannung pro Chip DC Reverse voltage per chip DC ( $T_{\text{board}}=25^\circ\text{C}$ )	$V_R$	0.5			V
Sperrstrom pro Chip DC Reverse current per chip DC $V_R = 0.5 \text{ V}$	$I_R$	10			mA

\* Eine Betauung des Moduls muss vermieden werden.  
Condensation on the module has to be avoided.

**Kennwerte**  
**Characteristics**
 $(T_A = 25\text{ °C})$ 

Bezeichnung Parameter	Symbol Symbol	Werte Values			Einheit Unit
		amber	true green	blue	
Wellenlänge des emittierten Lichtes Wavelength at peak emission $I_F = 1\text{ A}$ (typ.)	$\lambda_{\text{peak}}$	627	516	460	nm
Dominantwellenlänge <sup>3) Seite 19</sup> Dominant wavelength <sup>3) page 19</sup> $I_F = 1\text{ A}$ (min.) (typ.) (max.)	$\lambda_{\text{dom}}$ $\lambda_{\text{dom}}$ $\lambda_{\text{dom}}$	611 617 625	509 520 533	456 464 469	nm nm nm
Spektrale Bandbreite bei 50 % $I_{V\text{rel max}}$ Spectral bandwidth at 50 % $I_{V\text{rel max}}$ $I_F = 1\text{ A}$ (typ.)	$\Delta\lambda$	26	44	30	nm
Abstrahlwinkel bei 50 % $I_V$ (Vollwinkel) Viewing angle at 50 % $I_V$ (typ.)	$2\varphi$	120			Grad deg.
Durchlassspannung pro Chip <sup>4) Seite 19</sup> Forward voltage per chip <sup>4) page 19</sup> $I_F = 1\text{ A}$ (min.) (typ.) (max.)	$V_F$ $V_F$ $V_F$	2.25 2.8 3.85	3.1 3.8 4.65		V V V
Optischer Wirkungsgrad Optical efficiency $I_F = 1\text{ A}$ (typ.)	$\eta_{\text{opt}}$	28	30	7	lm/W
Abstrahlende Fläche Radiating Surface (typ.)	$A_{\text{Color}}$	3.2 x 2.1			mm <sup>2</sup>
Leuchtdichte Luminance $I_F = 1\text{ A}$ (typ.)	$L_V$	$26 \cdot 10^6$	$41 \cdot 10^6$	$9 \cdot 10^6$	cd/m <sup>2</sup>
Partieller Lichtfluss Partial flux acc. CIE 127:2007 (typ.)	$\Phi_{\text{LED}, 120}$	$0.82 \times \Phi_{\text{LED}, 180}$			lm
Wärmewiderstand des gesamten Moduls Thermal resistance of the module Sperrschicht / Bodenplatte Junction / base plate	$R_{\text{th JB}}$	2.0 (typ.)			K/W

**SMD NTC Thermistors**  
**SMD NTC Thermistors**

$R_{25}$ [Ω]	No. of R/T characteristic s*	$B_{25/50}$ [K]	$B_{25/85}$ [K]	Resistance Tolerance $\Delta R_N/R_N$	B value Tolerance $\Delta B/B$	$P_{NTC,max,25}$ [mW]
10k	EPCOS 8502	3940	3980	± 5%	± 3%	180

\* for further information please visit [www.epcos.com](http://www.epcos.com)

$$R_T = R_N \cdot e^{B \cdot \left( \frac{1}{T} - \frac{1}{T_N} \right)}$$

$R_T$  = NTC resistance in Ω at temperature T in K  
 $R_N$  = NTC resistance in Ω at rated temperature  $T_N$   
 in K ( $T_N = 298$  K for test condition)  
 T,  $T_N$  = temperature in K  
 e = base of the natural logarithm (e = 2.71828)

B = B value, material specific constant of the NTC  
 thermistor

$$B = B_{N/T} = \frac{T \cdot T_N}{T - T_N} \cdot \ln \frac{R_N}{R_T}$$

**Typische Thermistor Kennlinie<sup>2) 5) Seite 19</sup>**  
**Typical Thermistor Graph<sup>2) 5) page 19</sup>**

$I_F = f(V_F); T_{board} = 25\text{ °C}$

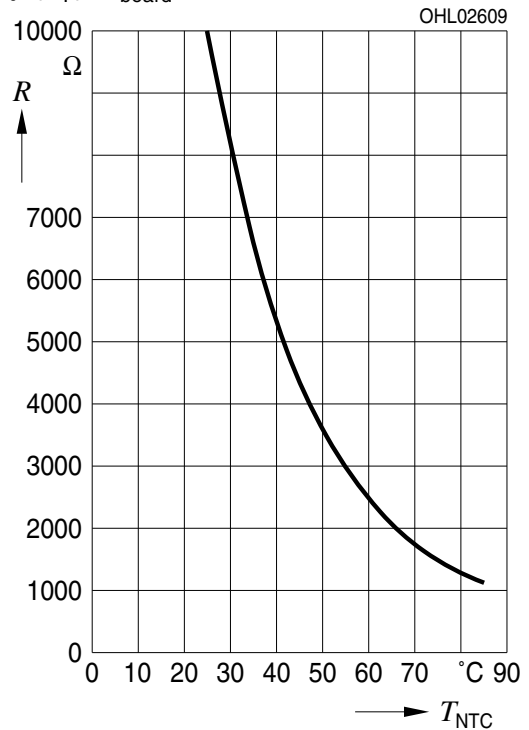

## Helligkeits-Gruppierungsschema Brightness Groups

	Helligkeitsgruppe Brightness Group	Lichtstärke <sup>1) Seite 19</sup> Luminous Intensity <sup>1) page 19</sup> $I_V$ (cd)	Lichtstrom <sup>2) Seite 19</sup> Luminous Flux <sup>2) page 19</sup> $\Phi_V$ (lm)
amber; true green	LA	112 ... 140	380 (typ.)
	LB	140 ... 180	480 (typ.)
	MA	180 ... 224	600 (typ.)
	MB	224 ... 280	760 (typ.)
	NA	280 ... 355	950 (typ.)
blue	JA	45.0 ... 56.0	150 (typ.)
	JB	56.0 ... 71.0	190 (typ.)
	KA	71.0 ... 90.0	240 (typ.)

Anm.: Die Standardlieferform von Serientypen beinhaltet eine Familiengruppe. Diese besteht aus wenigen Helligkeitsgruppen. Einzelne Helligkeitsgruppen sind nicht bestellbar.

Note: The standard shipping format for serial types includes a family group of only a few individual brightness groups. Individual brightness groups cannot be ordered.

## Wellenlängengruppen (Dominantwellenlänge)<sup>3) Seite 19</sup> Wavelength Groups (Dominant Wavelength)<sup>3) page 19</sup>

Gruppe Group	amber		true green		blue		Einheit Unit
	min.	max.	min.	max.	min.	max.	
2			509	515	456	464	nm
3	611	619	515	521	464	469	nm
4	619	625	521	527			nm
5			527	533			nm

## Gruppenbezeichnung auf Etikett Group Name on Label

Beispiel: LA-3

Example: LA-3

Helligkeitsgruppe Brightness Group	Wellenlänge Wavelength
LA	3

Anm.: In einer Verpackungseinheit ist immer nur eine Gruppe für jede Selektion enthalten.

Note: No packing unit ever contains more than one group for each selection.

**Relative spektrale Emission pro Chip**<sup>2) Seite 19</sup>

**Relative Spectral Emission per Chip**<sup>2) page 19</sup>

$V(\lambda)$  = spektrale Augenempfindlichkeit / Standard eye response curve

$I_{rel} = f(\lambda), T_A = 25\text{ °C}, I_F = 1\text{ A}$

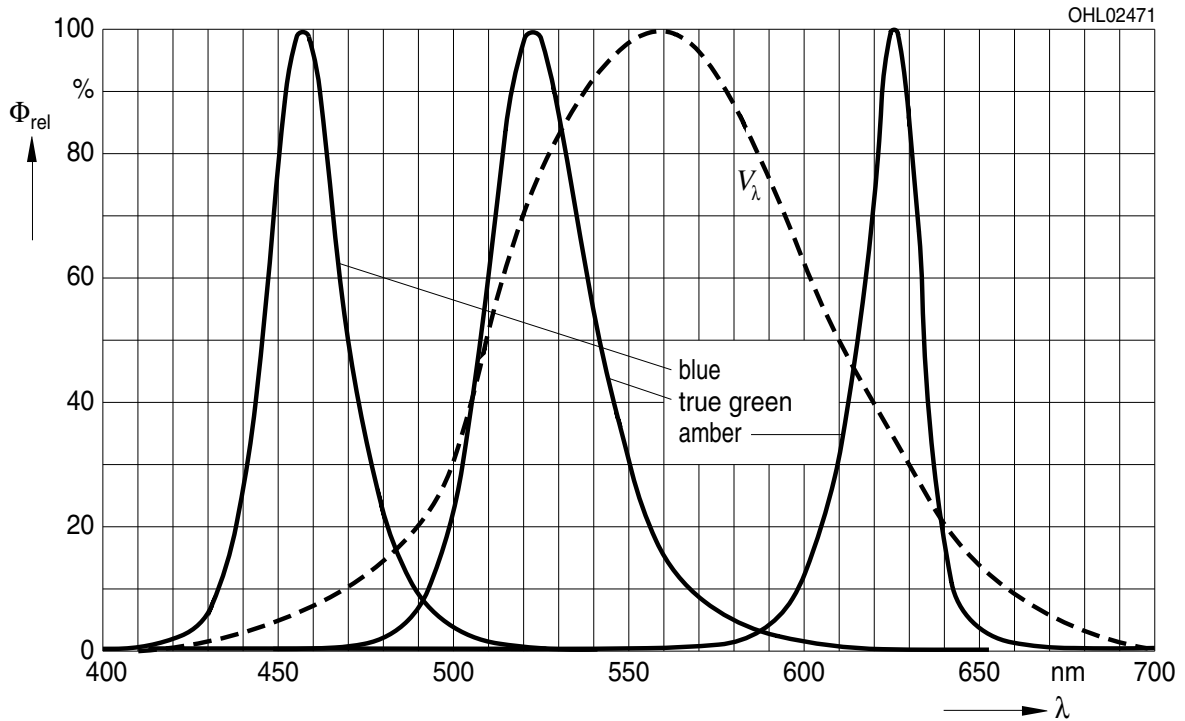

**Abstrahlcharakteristik**<sup>2) Seite 19</sup>

**Radiation Characteristic**<sup>2) page 19</sup>

$I_{rel} = f(\varphi); T_A = 25\text{ °C}$

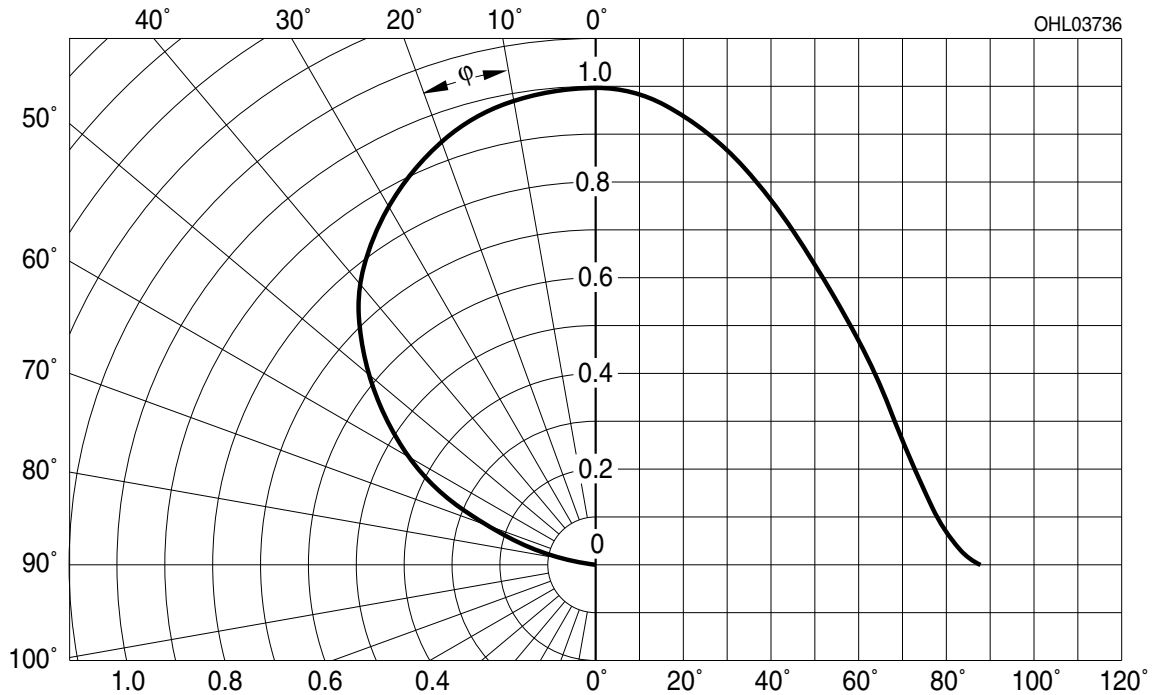

Durchlassstrom pro Chip<sup>2)</sup> Seite 19  
 Forward Current per chip<sup>2)</sup> page 19

$I_F = f(V_F); T_A = 25\text{ °C}; \text{LE A G3W}$

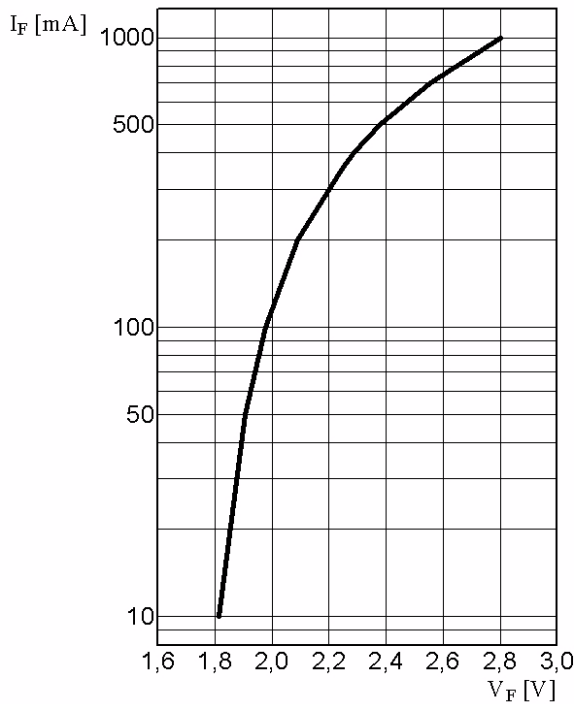

Durchlassstrom pro Chip<sup>2)</sup> Seite 19  
 Forward Current per chip<sup>2)</sup> page 19

$I_F = f(V_F); T_A = 25\text{ °C}; \text{LE T G3W}; \text{LE B G3W}$

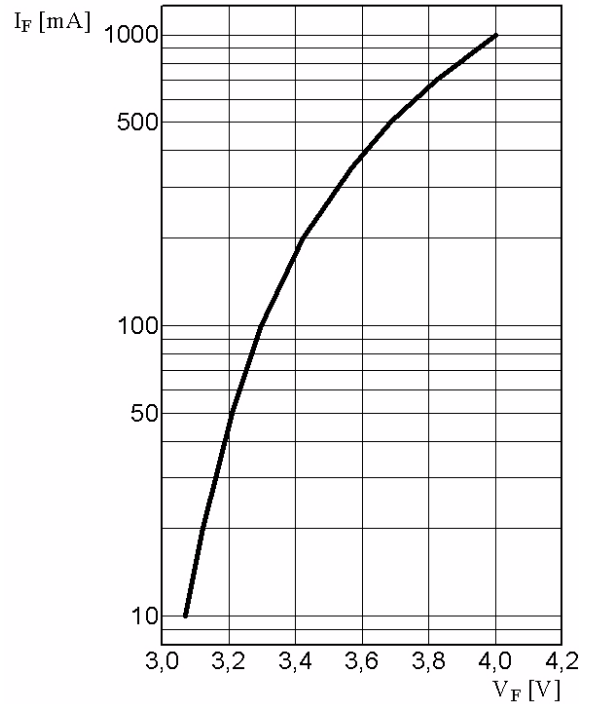

Relative Lichtstärke<sup>2) 6)</sup> Seite 19

Relative Luminous Intensity<sup>2) 6)</sup> page 19

$I_V/I_V(1\text{ A}) = f(I_F < 1\text{ A}); T_A = 25\text{ °C}; t_p = 1\text{ ms}, D = 0,0003$

LE A G3W

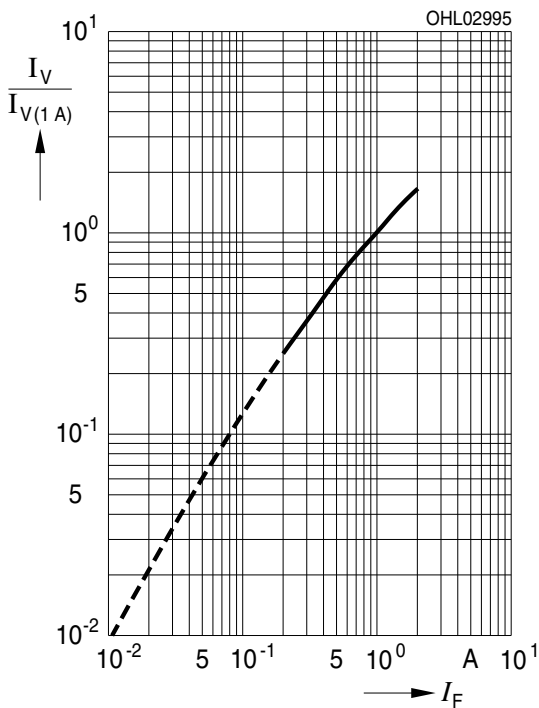

Relative Lichtstärke<sup>2) 6)</sup> Seite 19

Relative Luminous Intensity<sup>2) 6)</sup> page 19

$I_V/I_V(1\text{ A}) = f(I_F > 1\text{ A}); T_A = 25\text{ °C}; t_p = 1\text{ ms}, D = 0,0003$

LE A G3W

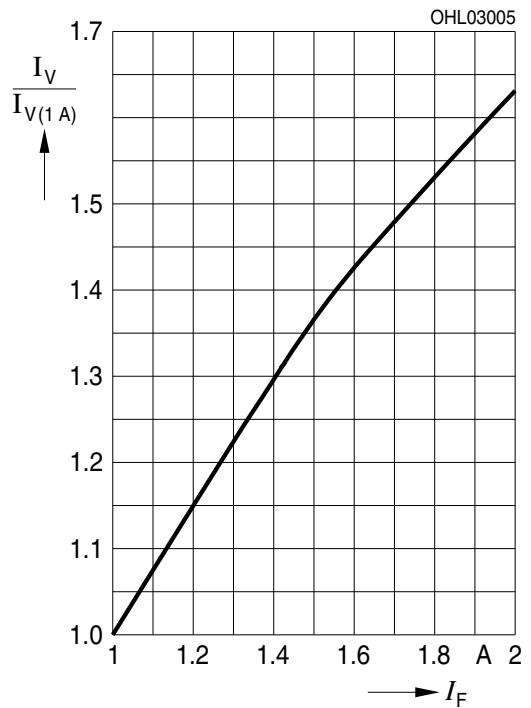



Relative Lichtstärke<sup>2) 6) Seite 19</sup>

Relative Luminous Intensity<sup>2) 6) page 19</sup>

$I_V/I_V(1\text{ A}) = f(I_F < 1\text{ A}); T_A = 25\text{ °C}; t_p = 1\text{ ms}, D = 0,0003$

LE T G3W; LE B G3W

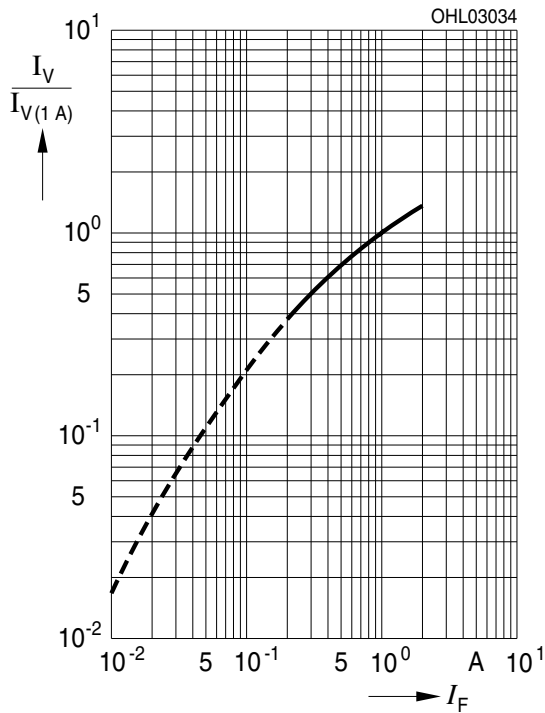

Relative Lichtstärke<sup>2) 6) Seite 19</sup>

Relative Luminous Intensity<sup>2) 6) page 19</sup>

$I_V/I_V(1\text{ A}) = f(I_F > 1\text{ A}); T_A = 25\text{ °C}; t_p = 1\text{ ms}, D = 0,0003$

LE T G3W; LE B G3W

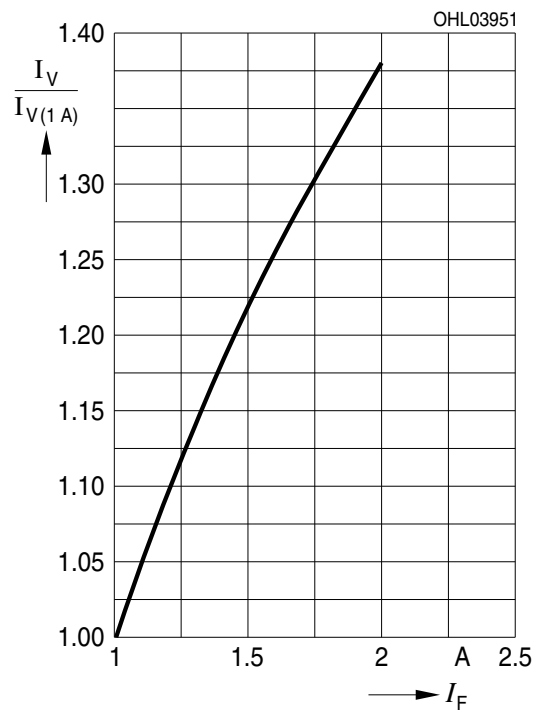

Dominante Wellenlänge<sup>2) Seite 19</sup>

Dominant Wavelength<sup>2) page 19</sup>

$\lambda_{\text{dom}} = f(I_F); T_A = 25\text{ °C}; \text{LE A G3W}$

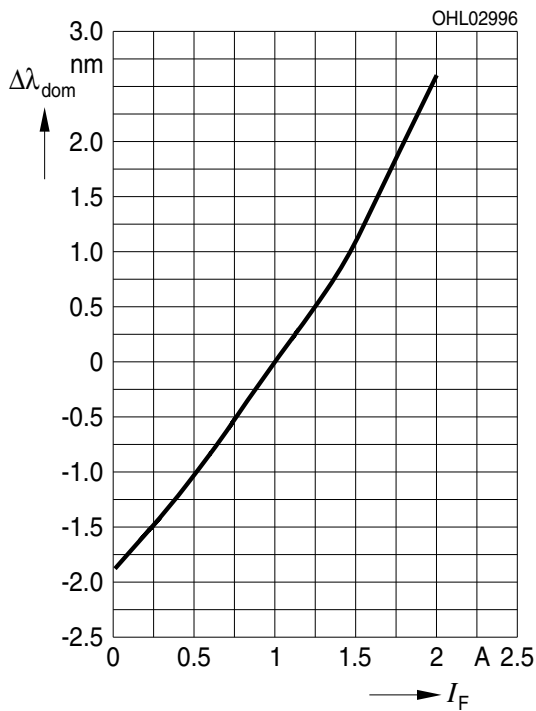

Dominante Wellenlänge<sup>2) Seite 19</sup>

Dominant Wavelength<sup>2) page 19</sup>

$\lambda_{\text{dom}} = f(I_F); T_A = 25\text{ °C}; \text{LE T G3W}$

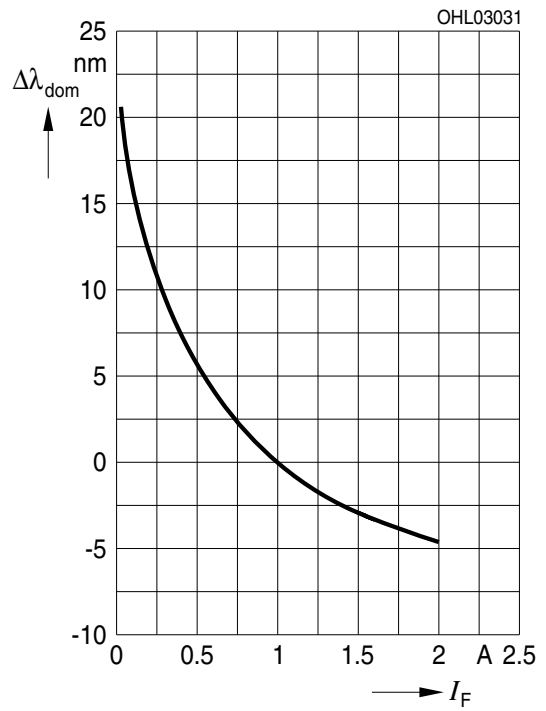

Dominante Wellenlänge<sup>2)</sup> Seite 19

Dominant Wavelength<sup>2)</sup> page 19

$\lambda_{\text{dom}} = f(I_F); T_A = 25 \text{ °C}; \text{LE B G3W}$

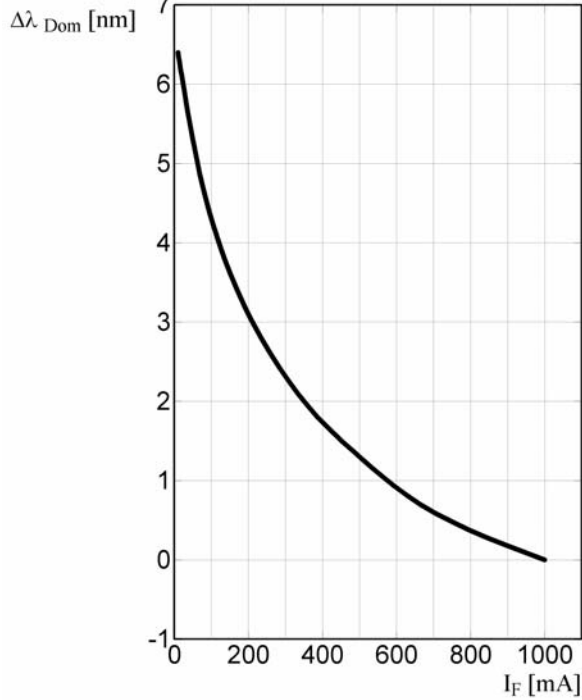

Relative Vorwärtsspannung<sup>2)</sup> Seite 19

Relative Forward Voltage<sup>2)</sup> page 19

$\Delta V_F = V_F - V_F(25 \text{ °C}) = f(T_j); I_F = 1 \text{ A}$

LE A G3W

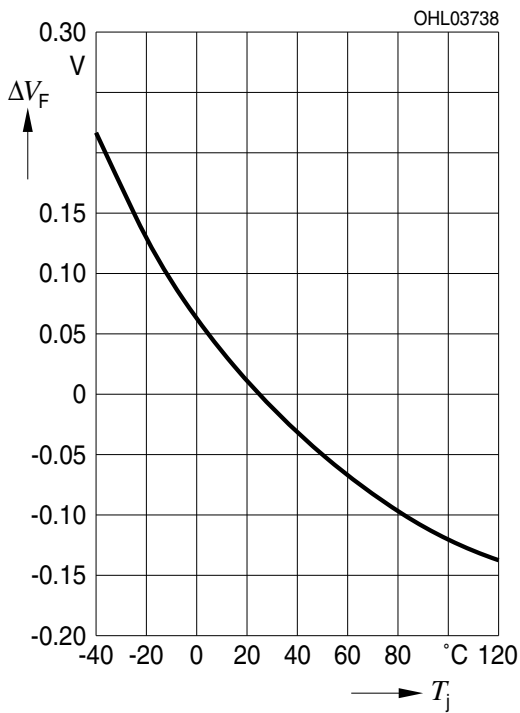

Relative Vorwärtsspannung<sup>2)</sup> Seite 19

Relative Forward Voltage<sup>2)</sup> page 19

$\Delta V_F = V_F - V_F(25 \text{ °C}) = f(T_j); I_F = 1 \text{ A}$

LE T G3W; LE B G3W

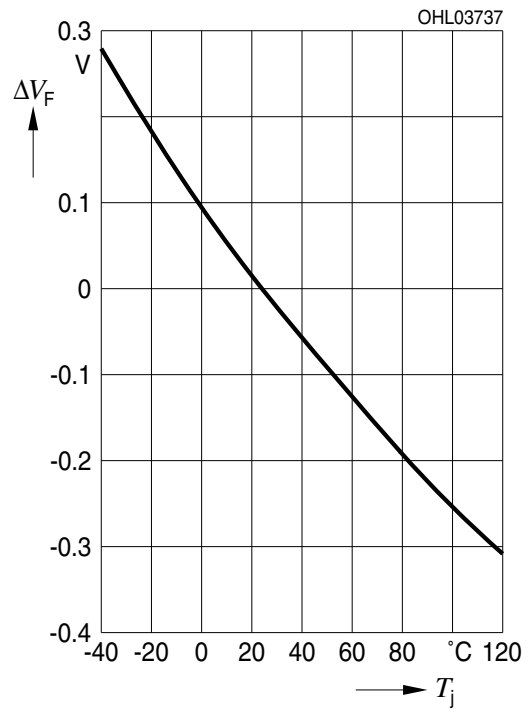

Relative Lichtstärke<sup>2)</sup> Seite 19

Relative Luminous Intensity<sup>2)</sup> page 19

$I_V/I_V(25\text{ °C}) = f(T_j)$ ;  $I_F = 1\text{ A}$ ; **LE A G3W**

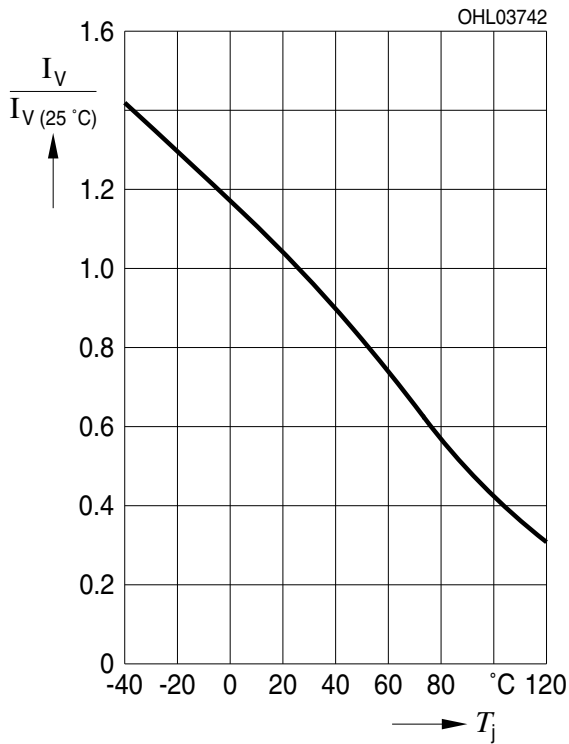

Relative Lichtstärke<sup>2)</sup> Seite 19

Relative Luminous Intensity<sup>2)</sup> page 19

$I_V/I_V(25\text{ °C}) = f(T_j)$ ;  $I_F = 1\text{ A}$ ; **LE T G3W**

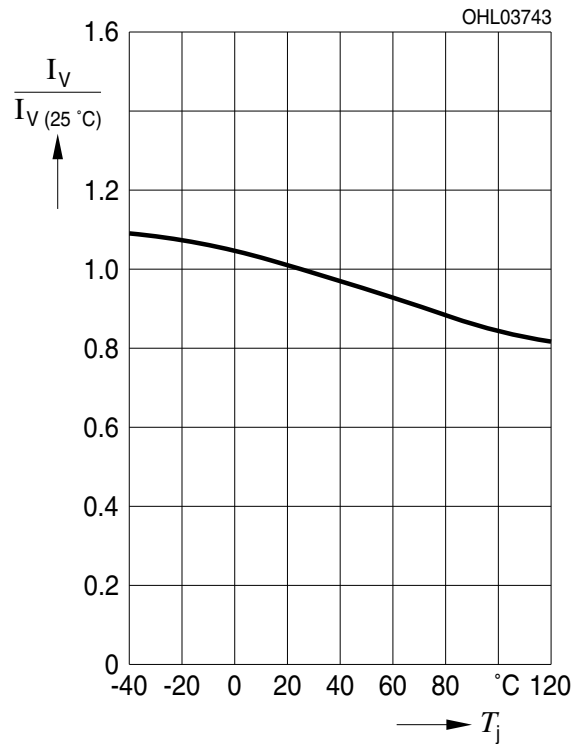

Relative Lichtstärke<sup>2)</sup> Seite 19

Relative Luminous Intensity<sup>2)</sup> page 19

$I_V/I_V(25\text{ °C}) = f(T_j)$ ;  $I_F = 1\text{ A}$ ; **LE B G3W**

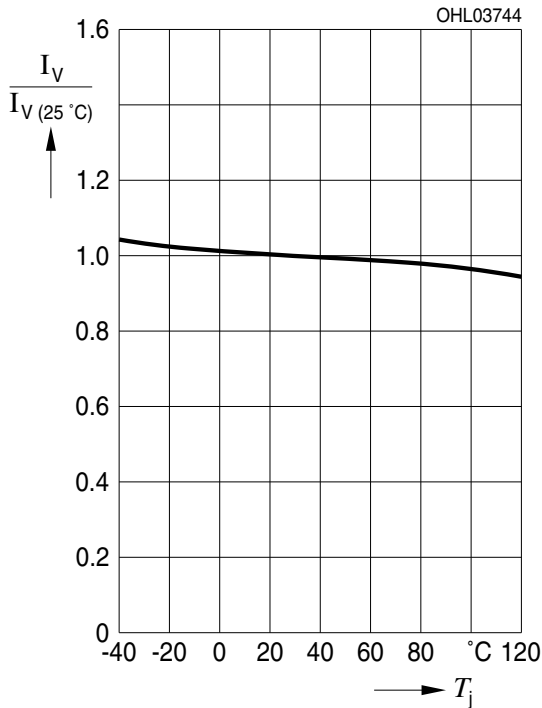

**Dominante Wellenlänge<sup>2)</sup> Seite 19**

**Dominant Wavelength<sup>2)</sup> page 19**

$\lambda_{\text{dom}} = f(T_j); I_F = 1 \text{ A}; \text{LE A G3W}$

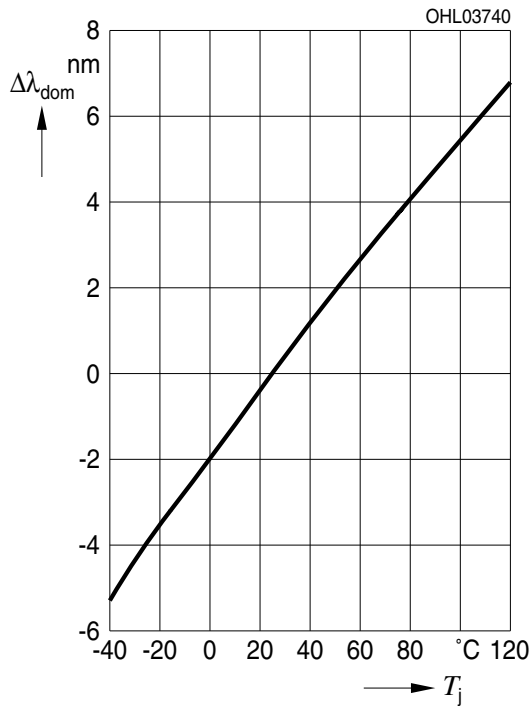

**Dominante Wellenlänge<sup>2)</sup> Seite 19**

**Dominant Wavelength<sup>2)</sup> page 19**

$\lambda_{\text{dom}} = f(T_j); I_F = 1 \text{ A}; \text{LE T G3W}$

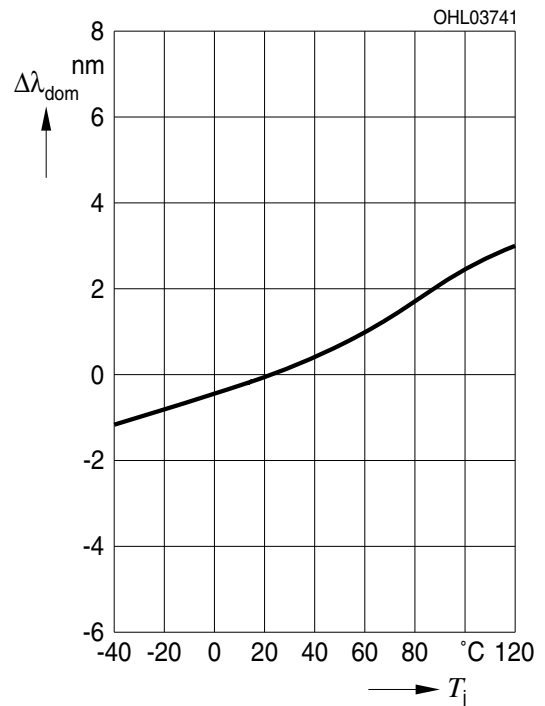

**Dominante Wellenlänge<sup>2)</sup> Seite 19**

**Dominant Wavelength<sup>2)</sup> page 19**

$\lambda_{\text{dom}} = f(T_j); I_F = 1 \text{ A}; \text{LE B G3W}$

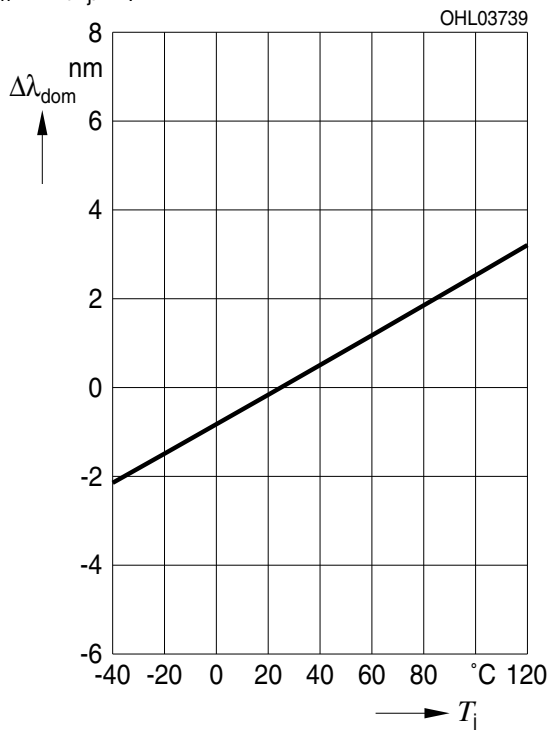

**Transient Thermal resistance**

**Z<sub>th</sub>\*(frequency,DC) for 6Chips operated**

6 Chips operated;  $I_F = f(T_S)$

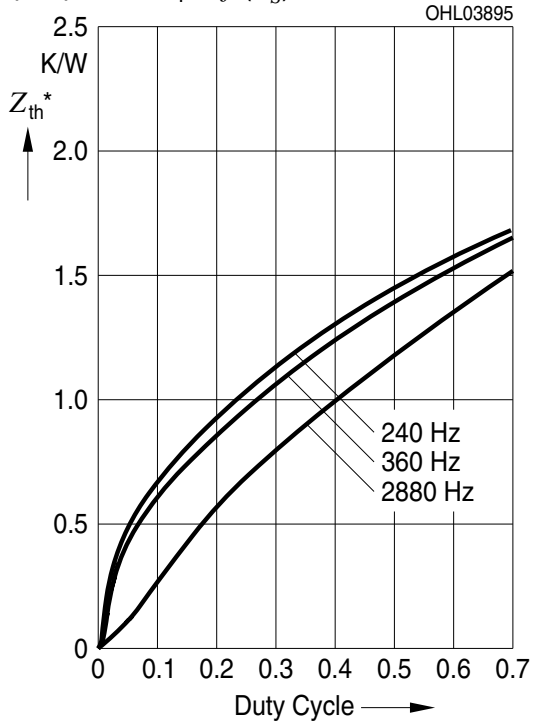

**Zulässige Impulsbelastbarkeit  $I_F = f(t_p)$**

**Permissible Pulse Handling Capability**

Duty cycle  $D =$  parameter,  $T_{board} = 55\text{ °C}$   
6 chips operated simultaneously in series

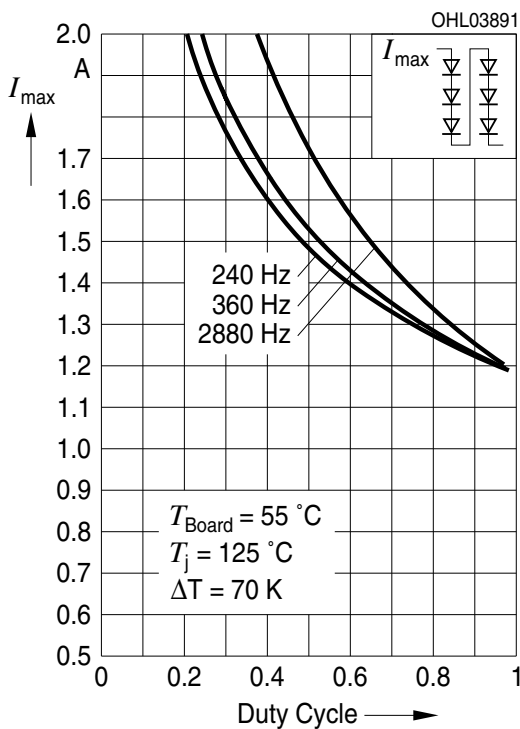

**Zulässige Impulsbelastbarkeit  $I_F = f(t_p)$**

**Permissible Pulse Handling Capability**

Duty cycle  $D =$  parameter,  $T_{board} = 85\text{ °C}$   
6 chips operated simultaneously in series

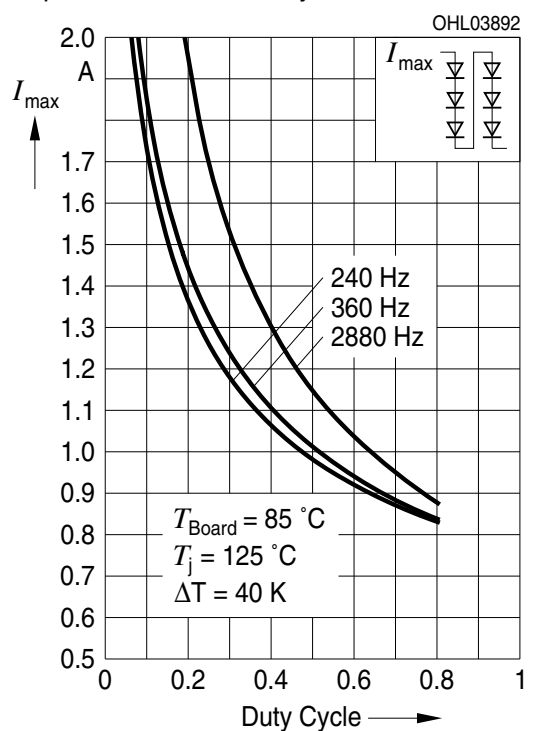

Maßzeichnung 7) Seite 19  
 Package Outlines 7) page 19

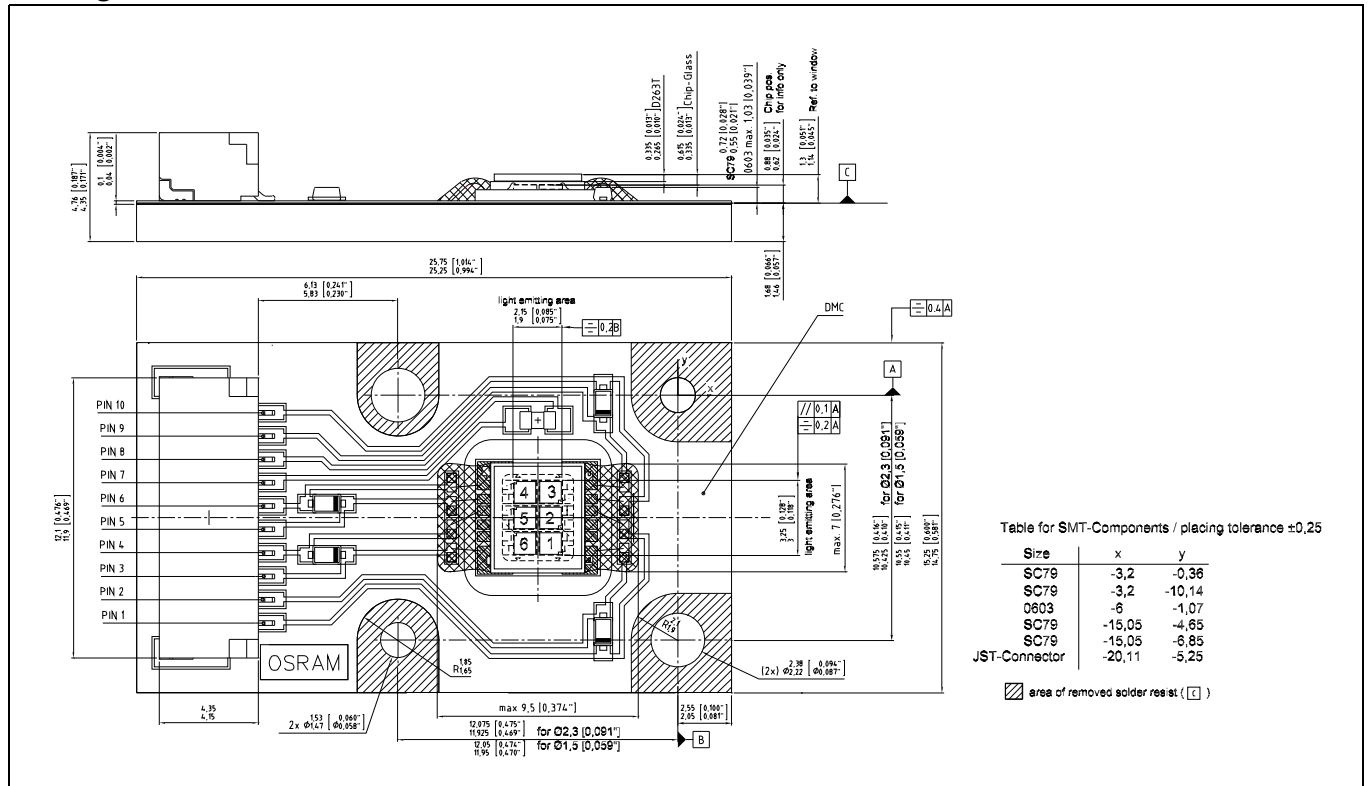

**Chip-Position:**

**LE A G3W**

1-6: amber

**LE T G3W**

1-6: true green

**LE B G3W**

1-6: blue

**Pin-Assignment:**

- 1: Anode; Chip 1, 2
- 2: Cathode; Chip 1, 2
- 3: Anode; Chip 5, 6
- 4: Cathode; Chip 5, 6
- 5: Anode; Chip 4
- 6: Cathode; Chip 4
- 7: NTC
- 8: NTC
- 9: Anode; Chip 3
- 10: Cathode; Chip 3

Verwendeter Stecker / Used male connector on board:

Empfohlene Gegenstecker /

Recommended female connector for power supply:

Kontakt - Pins:

JST SM10B-SRSS-TB ([www.jst.com](http://www.jst.com))

JST SHR-10V-S ([www.jst.com](http://www.jst.com))

JST SHR-10V-S-B ([www.jst.com](http://www.jst.com))

SSH-003T-P0.2 ([www.jst.com](http://www.jst.com))

**Korrosionsfestigkeit besser als EN 60068-2-60 (method 4):**

mit erweitertem Korrosionstest: 40°C / 90%rh / 15ppm H2S / 336h

**Corrosion robustness better than EN 60068-2-60 (method 4):**

with enhanced corrosion test: 40°C / 90%rh / 15ppm H2S / 336h

**Gewicht / Approx. weight:**

5.3 mg

**Connecting and disconnecting OSRAM OS Ostar Projection modules**

When connecting or disconnecting an Ostar Projection module care has to be taken in order to prevent a damage of the module. The module is equipped with a male connector socket (JST SM 10B-SR SS-TB). As a female connector for power supply a JST SHR-10V-S (without protrusions) or a JST SHR-10V-S-B (with protrusions) with SSH-003T-P0.2 pins is recommended.

When disconnecting the connector the applied pull force must not exceed 17 N \* (footnote \* A force of 17 N can only be applied dynamically during disconnecting. No constant force must be applied to the connector.) Disconnection of the module during operation or at high temperatures can damage the module. The board temperature must not exceed 40°C during disconnection. During mating operation, mate connectors while holding wires in a bundle on the same axis to the mating axis. For unmating wires must be held in a bundle within 20 degrees to the mating axis (see Fig. for explanation).

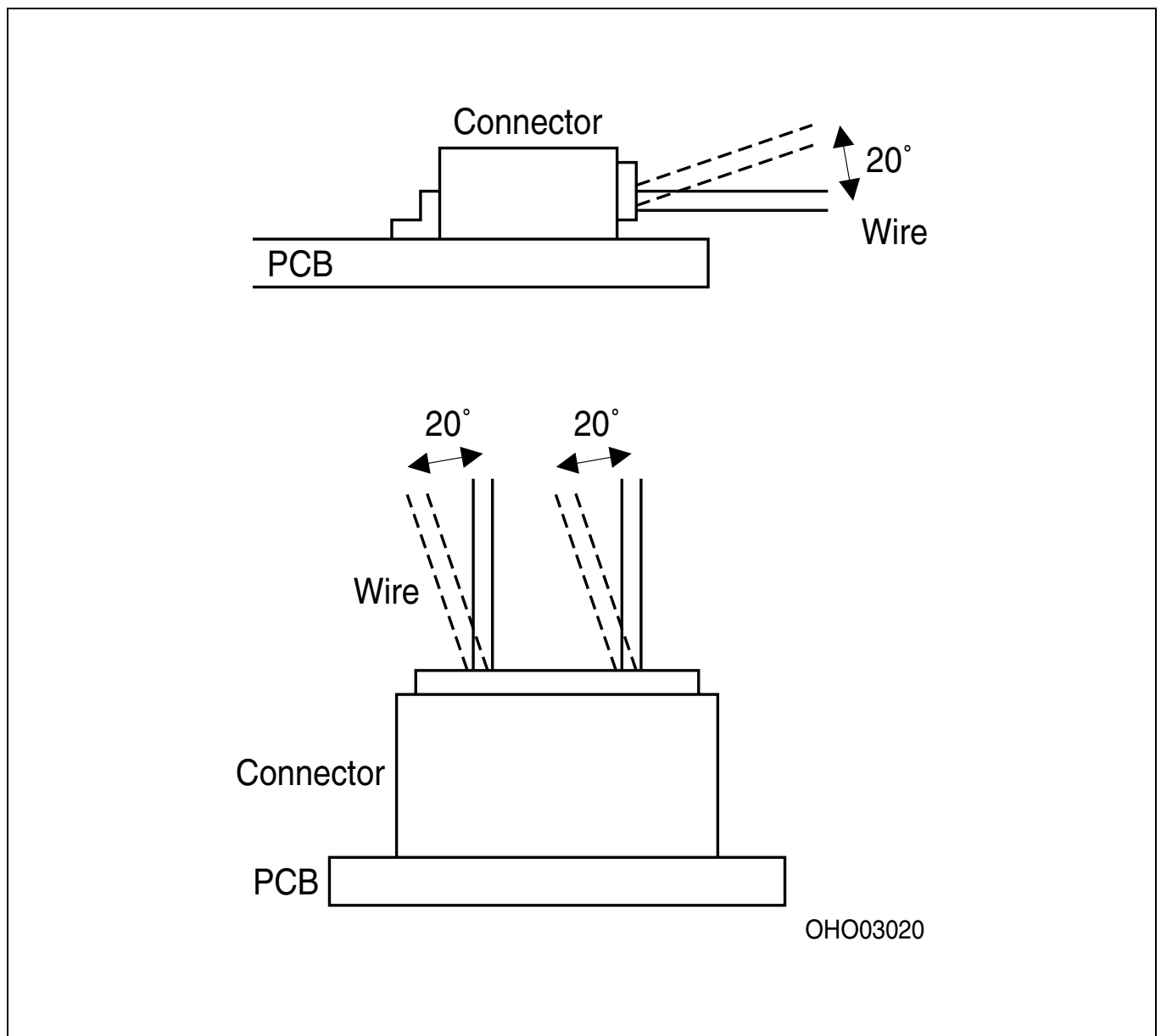

Verpackung 7) Seite 19

50 St. pro Box = Verpackungseinheit

Method of Packing 7) page 19

50 pcs. per tray = packing unit

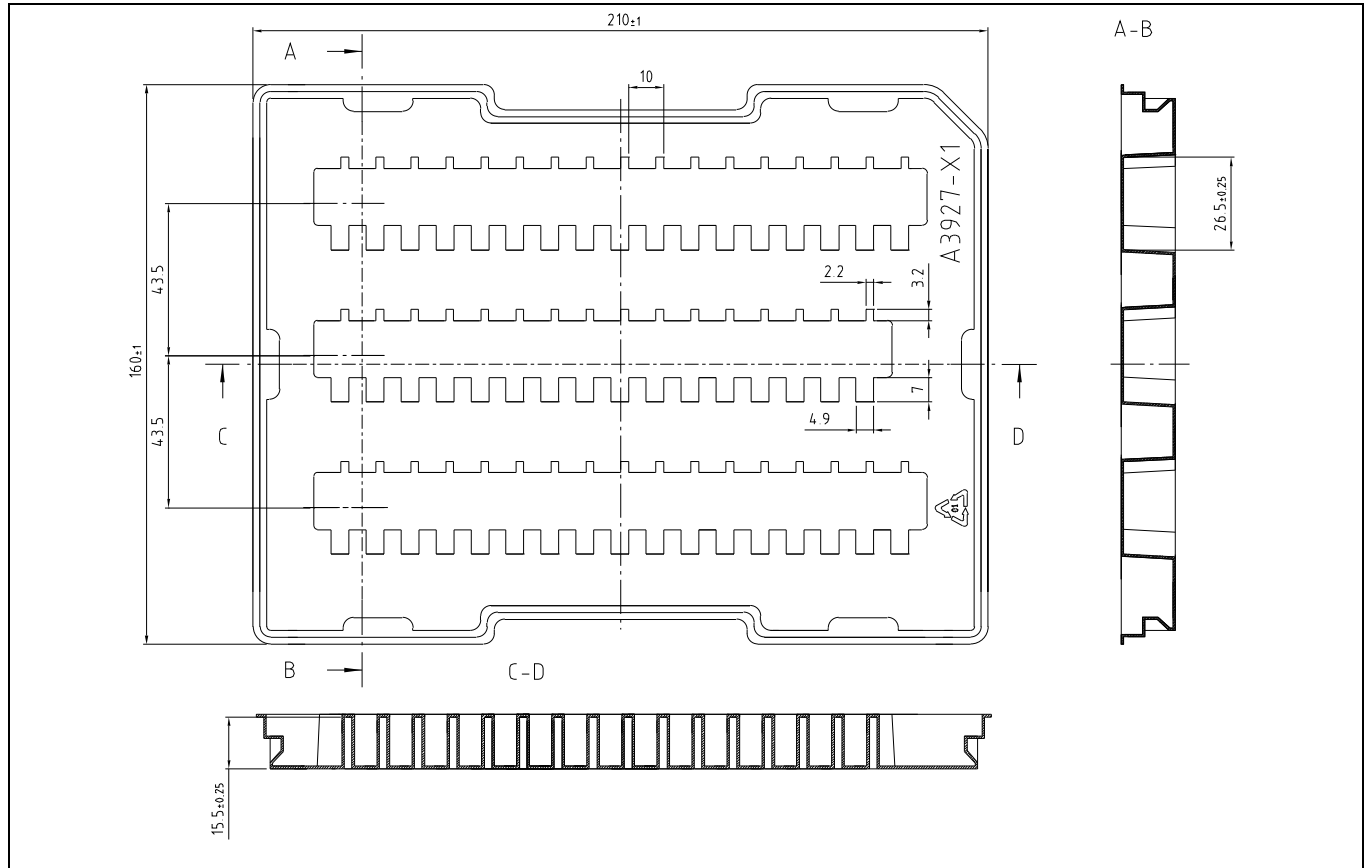

**Elektrisches Ersatzschaltbild**  
**Equivalent Circuit Diagram**

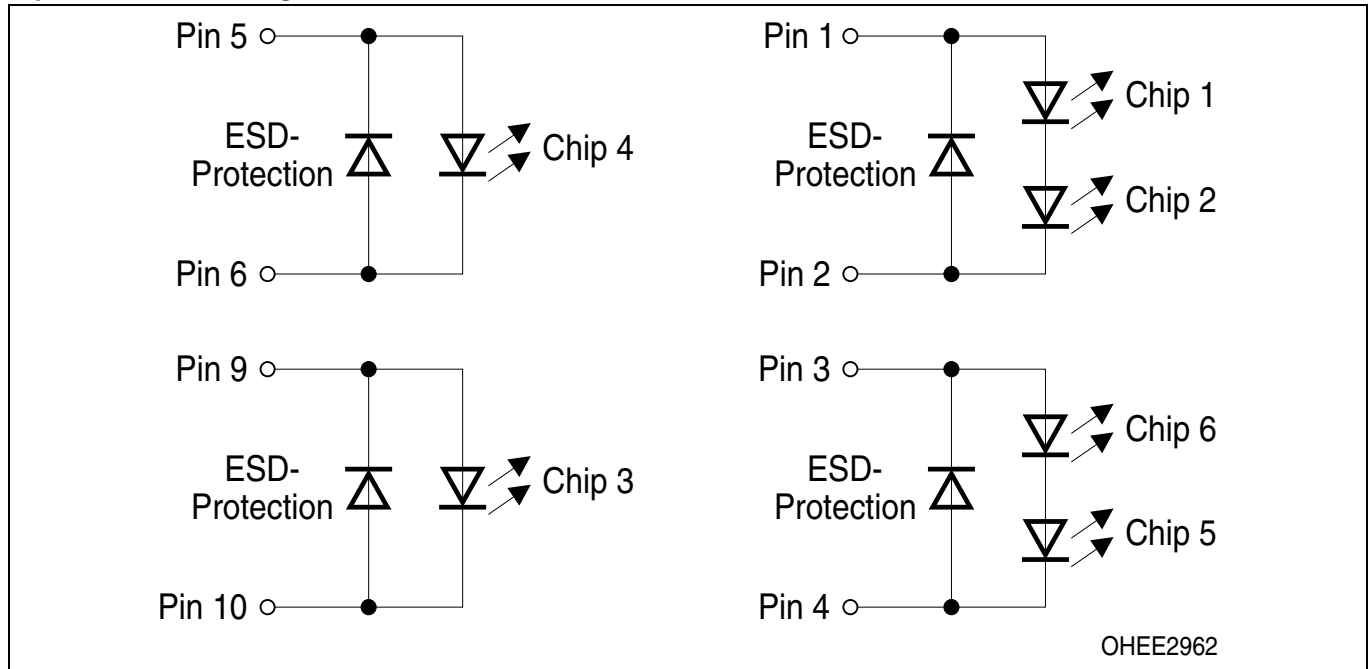



**Barcode-Tray-Etikett (BTL)**  
**Barcode-Tray-Label (BTL)**

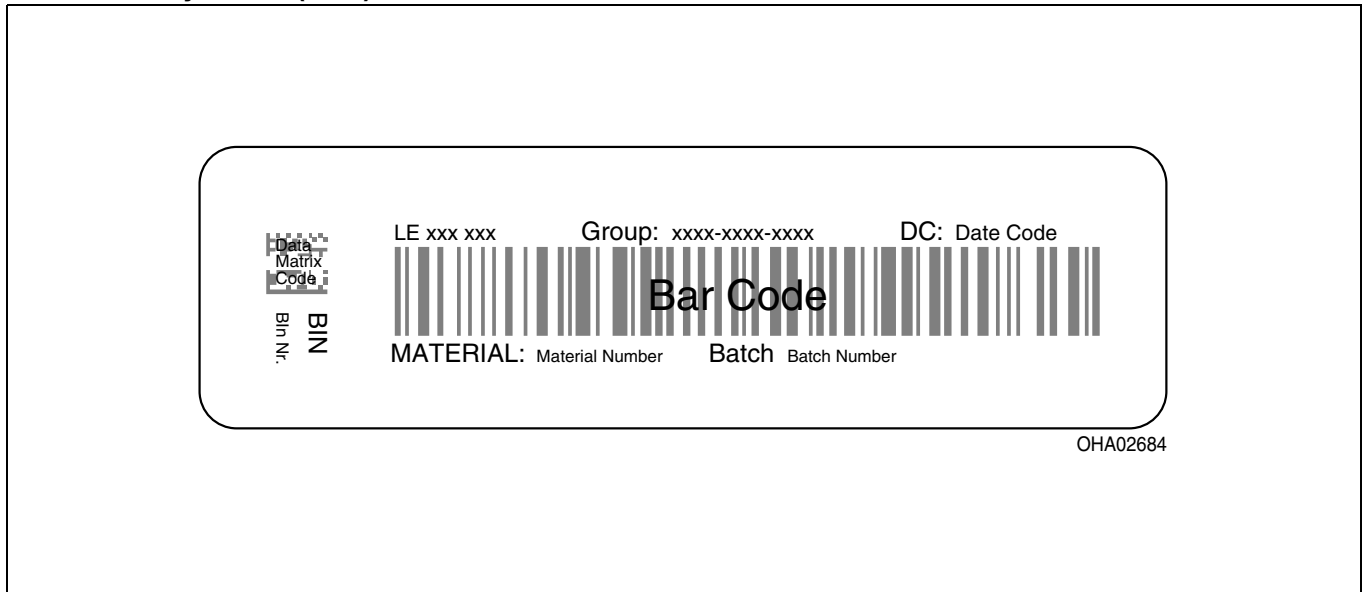

**Kartonverpackung und Materialien**  
**Transportation Packing and Materials**

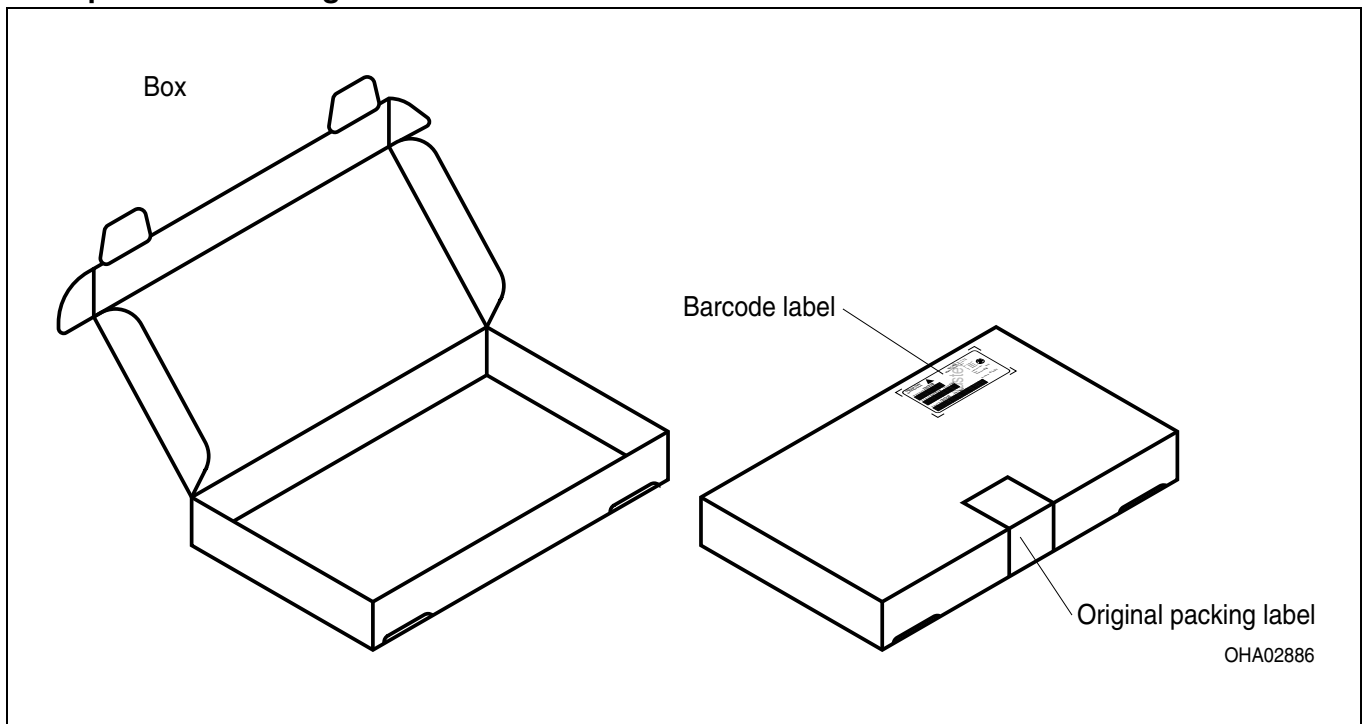

Dimensions of transportation box in mm (inch)

Breite / Width	Länge / length	Höhe / height
223 ±5 (8,7795 ±0,19685)	170 ±5 (6,6929 ±0,19685)	21 ±5 (0,826772 ±0,19685)

Revision History: 2010-03-03

Previous Version: 2009-02-05

Page	Subjects (major changes since last revision)	Date of change
1, 14	additional information	2010-03-03

Anm.: Wegen der Streichung der LED aus der IEC 60825-1 (2nd edition 2007-03) erfolgt die Bewertung der Augesicherheit nach dem Standard CIE S009/E:2002 ("photobiological safety of lamps and lamp systems") / IEC 62471 (1st edition 2006-07). Im Risikogruppensystem dieser CIE- Norm erfüllen die in diesem Datenblatt angegebenen LED die "moderate risk"- Gruppe (die sich im "sichtbaren" Spektralbereich auf eine Expositionsdauer von 0,25 s bezieht). Unter realen Umständen (für Expositionsdauer, Augenpupille, Betrachtungsabstand) geht damit von diesen Bauelementen keinerlei Augengefährdung aus. Grundsätzlich sollte jedoch erwähnt werden, dass intensive Lichtquellen durch ihre Blendwirkung ein hohes sekundäres Gefahrenpotenzial besitzen. Wie nach dem Blick in andere helle Lichtquellen (z.B. Autoscheinwerfer) auch, können temporär eingeschränktes Sehvermögen und Nachbilder je nach Situation zu Irritationen, Belästigungen, Beeinträchtigungen oder sogar Unfällen führen.

Note: Due to the cancellation of the LED from IEC 608251 (2nd edition 2007-03) , the evaluation of eye safety occurs according to the dual IEC/CIE logo standard CIE S009/E:2002 ("photobiological safety of lamps and lamp systems")- IEC 62471 (1st edition 2006-07). Within the risk grouping system of this CIE standard, the LEDs specified in this data sheet fall into the "Imoderate risk" group (relating to devices in the visible spectrum with an exposure time of 0.25s). Under real circumstances (for exposure time, eye pupils, observation distance), it is assumed that no endangerment to the eye exists from these devices. As a matter of principle, however, it should be mentioned that intense light sources have a high secondary exposure potential due to their blinding effect. As is also true when viewing other bright light sources (e.g. headlights), temporary reduction in visual acuity and afterimages can occur, leading to irritation, annoyance, visual impairment, and even accidents, depending on the situation.

### Attention please!

The information describes the type of component and shall not be considered as assured characteristics. Terms of delivery and rights to change design reserved. Due to technical requirements components may contain dangerous substances. For information on the types in question please contact our Sales Organization. If printed or downloaded, please find the latest version in the Internet.

### Packing

Please use the recycling operators known to you. We can also help you – get in touch with your nearest sales office. By agreement we will take packing material back, if it is sorted. You must bear the costs of transport. For packing material that is returned to us unsorted or which we are not obliged to accept, we shall have to invoice you for any costs incurred.

**Components used in life-support devices or systems must be expressly authorized for such purpose!** Critical components<sup>10) page 19</sup> may only be used in life-support devices or systems<sup>11) page 19</sup> with the express written approval of OSRAM OS.

## Fußnoten:

- 1) Helligkeitswerte werden mit einer Stromeinprägedauer von 25 ms und einer Genauigkeit von  $\pm 11\%$  ermittelt. Messbedingung für Lichtstärkemessung nach CIE127 Condition A.
- 2) Wegen der besonderen Prozessbedingungen bei der Herstellung von LED können typische oder abgeleitete technische Parameter nur aufgrund statistischer Werte wiedergegeben werden. Diese stimmen nicht notwendigerweise mit den Werten jedes einzelnen Produktes überein, dessen Werte sich von typischen und abgeleiteten Werten oder typischen Kennlinien unterscheiden können. Falls erforderlich, z.B. aufgrund technischer Verbesserungen, werden diese typischen Werte ohne weitere Ankündigung geändert.
- 3) Wellenlängen werden mit einer Stromeinprägedauer von 25 ms und einer Genauigkeit von  $\pm 1$  nm ermittelt.
- 4) Spannungswerte werden mit einer Stromeinprägedauer von 1 ms und einer Genauigkeit von  $\pm 0,1$  V ermittelt.
- 5) Die R-T-Kurve eines NTC läßt sich in einem engen Bereich um den spezifizierten Wert herum in erster Näherung durch einen exponentialen Zusammenhang beschreiben. Sofern eine detailliertere Beschreibung der R-T-Kurve für die Praxis nötig ist, können eine genauere Formel und entsprechende tabellierte Werte bei EPCOS gefunden werden.
- 6) Im gestrichelten Bereich der Kennlinien muss mit erhöhten Helligkeitsunterschieden zwischen Leuchtdioden innerhalb einer Verpackungseinheit gerechnet werden.
- 7) Maße werden wie folgt angegeben: mm (inch).
- 8) Ein kritisches Bauteil ist ein Bauteil, das in lebenserhaltenden Apparaten oder Systemen eingesetzt wird und dessen Defekt voraussichtlich zu einer Fehlfunktion dieses lebenserhaltenden Apparates oder Systems führen wird oder die Sicherheit oder Effektivität dieses Apparates oder Systems beeinträchtigt.
- 9) Lebenserhaltende Apparate oder Systeme sind für (a) die Implantierung in den menschlichen Körper oder (b) für die Lebenserhaltung bestimmt. Falls sie versagen, kann davon ausgegangen werden, dass die Gesundheit und das Leben des Patienten in Gefahr ist.

## Remarks:

- 1) Brightness groups are tested at a current pulse duration of 25 ms and a tolerance of  $\pm 11\%$ . Condition for luminous intensity measurement acc. to CIE127 condition A
- 2) Due to the special conditions of the manufacturing processes of LED, the typical data or calculated correlations of technical parameters can only reflect statistical figures. These do not necessarily correspond to the actual parameters of each single product, which could differ from the typical data and calculated correlations or the typical characteristic line. If requested, e.g. because of technical improvements, these typ. data will be changed without any further notice.
- 3) Wavelengths are tested at a current pulse duration of 25 ms and a tolerance of  $\pm 1$  nm.
- 4) Forward voltages are tested at a current pulse duration of 1 ms and a tolerance of  $\pm 0.1$  V.
- 5) The R-T-Curve of an NTC thermistor can be roughly described in a restricted range around the rated temperature. If a more precise description of the R/T curve is required for practical applications a refined formular and the corresponding tabulated values can be found at EPCOS
- 6) In the range where the line of the graph is broken, you must expect higher brightness differences between single LEDs within one packing unit.
- 7) Dimensions are specified as follows: mm (inch).
- 8) A critical component is a component used in a life-support device or system whose failure can reasonably be expected to cause the failure of that life-support device or system, or to affect its safety or the effectiveness of that device or system.
- 9) Life support devices or systems are intended (a) to be implanted in the human body, or (b) to support and/or maintain and sustain human life. If they fail, it is reasonable to assume that the health and the life of the user may be endangered.

Published by  
**OSRAM Opto Semiconductors GmbH**  
Leibnizstraße 4, D-93055 Regensburg  
[www.osram-os.com](http://www.osram-os.com)  
© All Rights Reserved.

EU RoHS and China RoHS compliant product



此产品符合欧盟 RoHS 指令的要求；

按照中国的相关法规和标准，不含有毒有害物质或元素。