

## *i*Coupler **ADuM3070** Isolated Switch Regulator With Integrated Feedback Evaluation Board

### FEATURES

- 2 independent **ADuM3070** circuits including 2.5 kV rms isolated dc-to-dc converters
- Single supply
  - 5 V in to 5 V out (regulated)
  - Reconfigurable to 5 V in to 3.3 V out or 3.3 V in to 3.3 V out
- Double supply
  - 5 V in to 15 V out (regulated) and 7.5 V out (unregulated)
  - Reconfigurable to 5 V in to 12 V out (regulated) and 6 V out (unregulated)
- Footprints for Coilcraft and Halo transformer options
- Multiple switching frequency options

### SUPPORTED *i*Coupler MODELS

**ADuM3070**

### GENERAL DESCRIPTION

The **EVAL-ADuM3070EBZ** demonstrates two separate applications for the **ADuM3070** isolated switch regulator with integrated feedback. It has two independent power supply circuits: a double supply and a single supply. The switching frequency can be set from 200 kHz to 1000 kHz. The board supports a variety of I/O configurations and multiple transformer options. It is equipped with two **ADuM3070** isolators.

### ADUM3070 EVALUATION BOARD

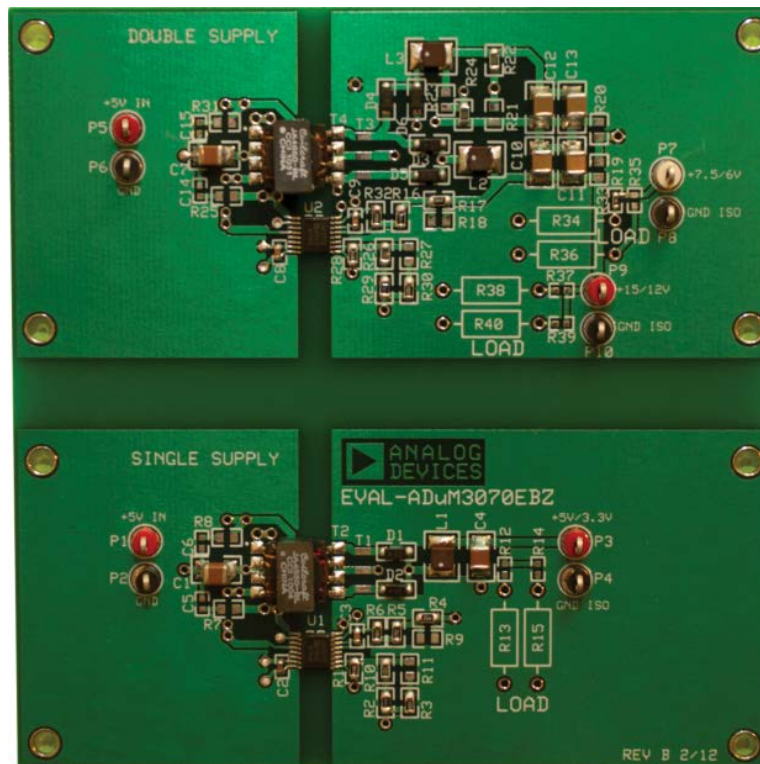

Figure 1. Double Supply (Top) and Single Supply (Bottom) Configurations

**TABLE OF CONTENTS**

Features .....	1	Schematic.....	5
Supported iCoupler Models .....	1	Double Supply.....	6
General Description .....	1	Terminals .....	6
ADuM3070 Evaluation Board .....	1	Transformer Selection .....	7
Revision History .....	2	Switching Frequency Options.....	7
Single Supply .....	3	Other Secondary Isolated Supply Configurations .....	8
Terminals .....	3	Schematic.....	8
Transformer Selection.....	3	Evaluation Board Layout .....	9
Switching Frequency Options.....	3	Ordering Information.....	10
Other Input and Isolated Output Supply Options .....	4	Bill of Materials.....	10

**REVISION HISTORY**

5/12—Revision 0: Initial Version

## SINGLE SUPPLY

Two independent and isolated circuits comprise the [ADuM3070](#) evaluation board. The lower half of the board, shown in Figure 2, is for a single power supply configuration (see the [ADuM3070](#) data sheet for applications information about the [ADuM3070](#) in this configuration).



Figure 2. Single Supply Configuration

The single supply is configured as a 5 V secondary isolated supply with a 5 V primary input supply, which can provide up to 2.5 W of regulated, isolated power. It can be reconfigured for a 3.3 V secondary isolated supply with a 5 V or 3.3 V primary input supply (see the Other Input and Isolated Output Supply Options section). Figure 9 shows the single supply schematic.

### TERMINALS

The single supply has terminal blocks on Side 1 (the primary/power supply input side) and Side 2 (the secondary/power supply output side). A 4.3 mm isolation barrier separates Side 1 and Side 2. Figure 3 shows these terminal locations.

Table 1 summarizes the functions of the terminal connections. They are described in detail in the Input Power Connections and Output Power Connections sections.



Figure 3. Single Supply Terminals

### Input Power Connections

Connect 5 V to P1, labeled +5V IN (or +3.3 V for a 3.3 V primary input supply with a 3.3 V secondary isolated supply). Connect the negative supply to P2, labeled GND (GND1 on the schematic). These are the only off-board connections required for the single supply to function.

$V_{DD1}$  supplies the voltage to the transformer primary and to the [ADuM3070](#) supply voltage,  $V_{DDA}$  (see the [ADuM3070](#) data sheet for additional information about the  $V_{DDA}$  pin function).  $V_{DD1}$  and  $V_{DDA}$  are bypassed by a 47  $\mu\text{F}$  ceramic capacitor (C1) and a 0.1  $\mu\text{F}$  local bypass capacitor (C2) located close to the [ADuM3070](#). R7, R8, C5, and C6 are provided for an optional and unpopulated snubber, which can be used to reduce radiated emissions.

Power is transferred to Side 2 by a regulated push-pull converter comprising the [ADuM3070](#) (U1), an external transformer (T1 or T2), and other components (see the [ADuM3070](#) data sheet for an explanation of this circuit functionality).

### Output Power Connections

An output load can be connected to P3 (labeled +5V/3.3V on the silkscreen and not labeled on the schematic), which is the isolated, regulated 5 V output supply. Connect the return of the load to P4, which is the Side 2 ground reference. P4 is labeled GND ISO on the silkscreen and GND2 on the schematic. This supply can provide up to 500 mA in the default 5 V primary input supply, 5 V secondary isolated supply configuration. Figure 5 through Figure 8 in this user guide show how the power supply's efficiency varies with load current, switching frequency, and temperature.

Table 1. Single Supply Terminal Function Descriptions

Terminal	Pin	Label	Description
P1	1	+5V IN	Side 1 5 V primary input supply
P2	1	GND	Side 1 ground reference
P3	1	+5V/3.3V	Side 2 5 V secondary isolated supply
P4	1	GND ISO	Side 2 ground reference

Care must be taken to avoid driving the  $V_{DD2}$  output with an external voltage because this can result in permanent damage to the [ADuM3070](#).

### TRANSFORMER SELECTION

The [EVAL-ADuM3070EBZ](#) supports multiple transformer options. The single supply is equipped with a Halo TGSAD-260V6LF (T1) or a Coilcraft JA4631-BL (T2) 1:2 turns ratio transformer. The Coilcraft footprint is offset to the left of the Halo footprint. Figure 5 and Figure 7 show the efficiency curves for the single supply operating with a Coilcraft and a Halo transformer, respectively.

### SWITCHING FREQUENCY OPTIONS

The resistor connected from the [ADuM3070](#) oscillator control pin (OC) to ground sets the single supply switching frequency. Figure 4 shows the relationship between this resistance and the converter switching frequency. The [EVAL-ADuM3070EBZ](#) can be configured with 0  $\Omega$ , 0805 resistors to four different preset switching frequencies. Short-circuiting R10 sets R1 (300 k $\Omega$ ) and R2 (150 k $\Omega$ ) in parallel, and short-circuiting R11 sets R1 and R3 (100 k $\Omega$ ) in parallel. Table 2 lists the switching frequencies that can be selected by short- or open-circuiting R10 and R11.

The user can select a different switching frequency by removing R10 and R11 and then choosing R1 based on Figure 4. The board is configured for the 500 kHz setting by default. Figure 5 and Figure 7 show how the switching frequency affects the supply's efficiency with either transformer installed. Figure 6 shows how the efficiency curve varies over temperature with a 500 kHz switching frequency.

Table 2. Switching Frequency Selection

R10	R11	Roc	Switching Frequency
Open	Open	300 kΩ	200 kHz
0 Ω	Open	100 kΩ	500 kHz
Open	0 Ω	75 kΩ	700 kHz
0 Ω	0 Ω	50 kΩ	1 MHz

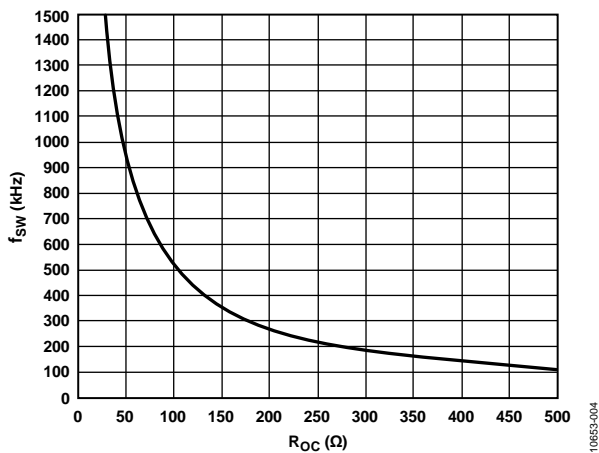

Figure 4. Switching Frequency vs. Roc Resistance

**OTHER INPUT AND ISOLATED OUTPUT SUPPLY OPTIONS**

The single supply can be configured to have a 3.3 V secondary isolated supply with a 3.3 V or 5 V primary input supply. Short-circuiting R4 by soldering a 0 Ω, 0805 resistor to R9 sets the output supply for 3.3 V. The voltage at the feedback node (the FB pin of the ADuM3070) should be the desired output voltage divided to approximately 1.25 V. Having R9 open-circuited sets the secondary isolated supply to 5 V, and having it short-circuited sets the supply to 3.3 V. See the ADuM3070 data sheet for more details on setting the secondary isolated output supply voltage. Figure 8 shows how the single supply efficiency curve changes when it is reconfigured for either of these supply options.

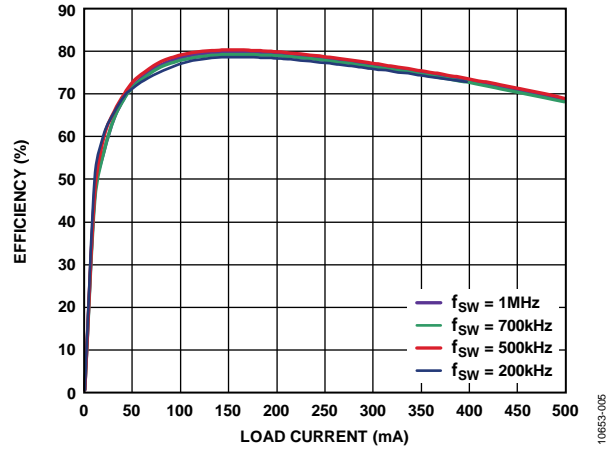

Figure 5. 5 V In to 5 V Out Efficiency with 1:2 Coilcraft Transformer at Various Switching Frequencies

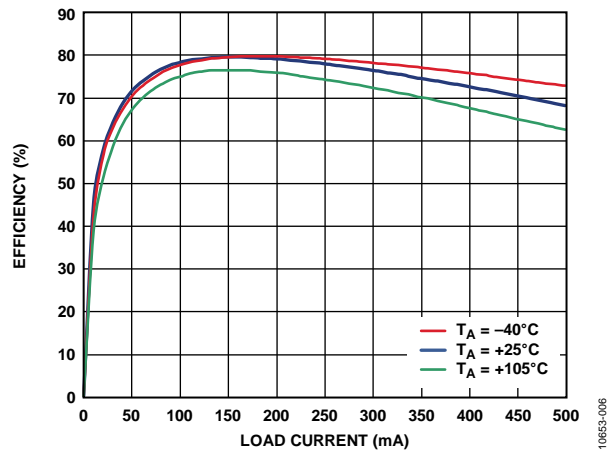

Figure 6. 5 V In to 5 V Out Efficiency with 1:2 Coilcraft Transformer at 500 kHz over Temperature

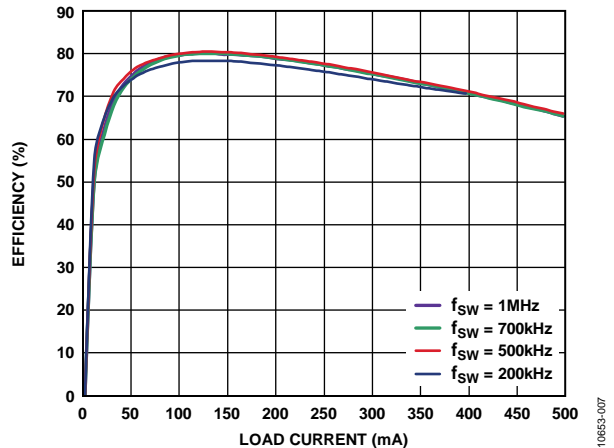

Figure 7. 5 V In to 5 V Out Efficiency with 1:2 Halo Transformer at Various Switching Frequencies

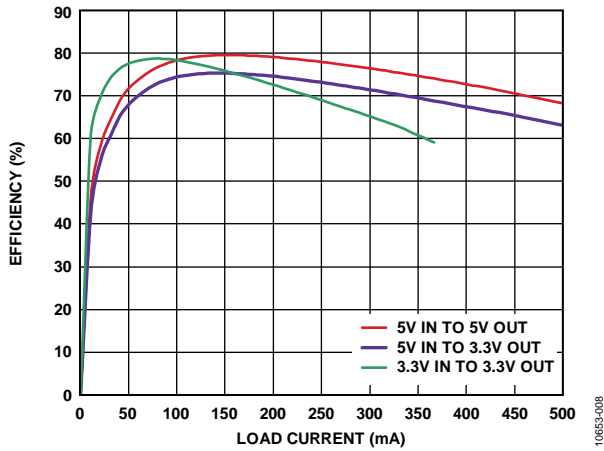
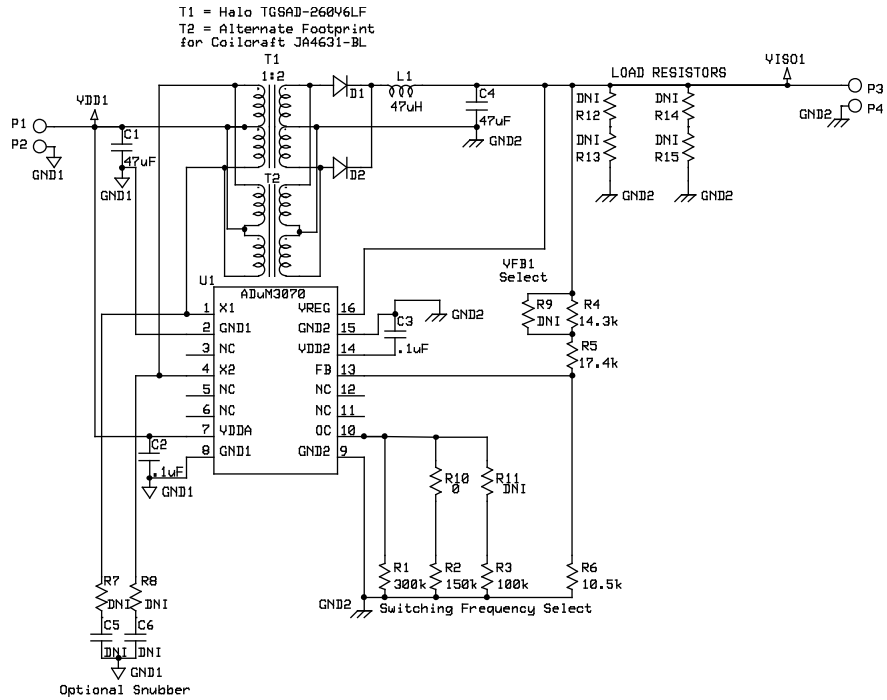

Figure 8. Single Supply Efficiency for Various Output Configurations with 1:2 Coilcraft Transformer at 500 kHz

SCHEMATIC



Notes:

- All resistors are 0805 packages.
- All .1uF are 0603 packages.
- All 22uF and 47 uF are 1210 packages.
- The diode footprints are for SOD-123 packages.
- All diodes are MBR0540 Schottky diodes.
- All inductors can be either 1212 or 1210s
- DNP = Do Not Populate / Not in BOM

Figure 9. Single Supply Schematic



## DOUBLE SUPPLY

The second power supply implemented with the [ADuM3070](#) on this evaluation board is a double supply. This circuit, which is shown in Figure 10, is located on the top half of the board. The [ADuM3070](#) data sheet also describes the [ADuM3070](#) in this configuration. Figure 17 shows the schematic.

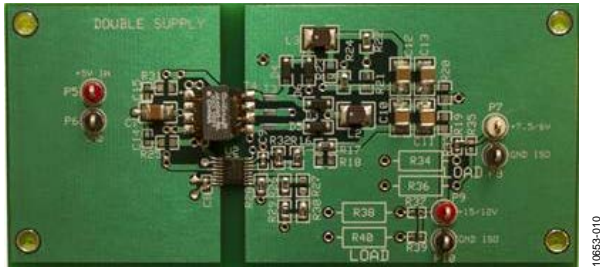

Figure 10. Double Supply Configuration

In its default configuration, the double supply provides a regulated 15 V output and an unregulated 7.5 V output, which are isolated from the 5 V primary input supply. The double supply is capable of delivering up to 140 mA to external loads. The isolated data channels on Side 2 load the secondary isolated supply and reduce the total available current. The double supply can be reconfigured as 12 V (regulated) and 6 V (unregulated) secondary isolated supplies or as positive and negative supplies. See the Other Secondary Isolated Supply Configurations section for more details.

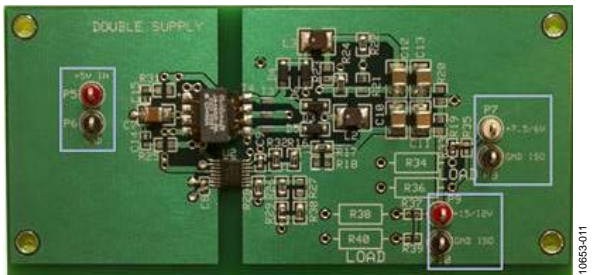

Figure 11. Double Supply Terminals

## TERMINALS

The double supply has terminal blocks on Side 1 (the primary/power supply input side) and Side 2 (the secondary/power supply output side). A 4.3 mm isolation barrier separates Side 1 and Side 2. Figure 11 shows these terminals. Table 3 summarizes the functions of the terminal connections. They are described in detail in the Input Power Connections and Output Power Connections sections.

### Input Power Connections

Connect 5 V to P5, labeled +5V IN. Connect the supply negative to P6, labeled GND (GND3 on the schematic). These are the only off-board connections required for the double supply to function.

$V_{DD2}$  supplies the voltage to the transformer primary and to the [ADuM3070](#) supply voltage,  $V_{DDA}$  (see the [ADuM3070](#) data sheet for additional information about the  $V_{DDA}$  pin function).  $V_{DD2}$

and  $V_{DDA}$  are bypassed by a 47  $\mu$ F ceramic capacitor (C7) and a 0.1  $\mu$ F local bypass capacitor (C8) located close to the [ADuM3070](#). R25, R31, C14, and C15 are provided for an optional and unpopulated snubber, which can be used to reduce radiated emissions.

### Output Power Connections

Output loads can be connected to P7 and P9, labeled VISO1 and VISO2, respectively, in the schematic and +7.5V/6V and +15/12V, respectively, on the silkscreen, which are the isolated, unregulated 7.5 V and regulated 15 V output supplies. Connect the return of the load to P8 and P10, which are labeled GND ISO on the silkscreen and GND4 in the schematic.

Side 2 is powered by the secondary isolated 15 V supply. The [ADuM3070](#) internal low dropout regulator converts this voltage to 5 V. The regulated 5 V supply powers the [ADuM3070](#) secondary side. Therefore, the [ADuM3070](#)  $V_{REG}$  pin is 15 V and the  $V_{DD2}$  pin is 5 V. The 15 V supply connects to P9. The 7.5 V supply connects to P7, which is labeled +7.5V/6V on the silkscreen and VISO1 on the schematic. The Side 2 ground reference is tied to P10. Note that the single and double supplies do not share grounds, although they have the same names on the silkscreen. The two supplies are isolated from each other with a greater than 15 mm gap. See the [ADuM3070](#) data sheet for an explanation of the double supply theory of operation. Figure 12 through Figure 15 show efficiency curves for the double supply with the +15/+12 V isolated output supply connected to  $V_{REG}$ .

### Powering $V_{REG}$ from the Unregulated 7.5 V Supply

$V_{REG}$  can be powered by the unregulated 7.5 V supply, which results in higher efficiency. However, when the 15 V supply is unloaded, the unregulated 7.5 V supply may drop to about 3 V, which may not be high enough to power the [ADuM3070](#) secondary side. This may cause the double supply to run open loop, leaving the 15 V supply unregulated. Using 15 V for  $V_{REG}$  ensures that the secondary side of the [ADuM3471](#) powers up under light load conditions. Move the 0  $\Omega$ , 0805 resistor from R19 to R20 to power Side 2 from the 7.5 V supply.

Care must be taken to avoid driving the  $V_{DD2}$  output because this can result in permanent damage to the [ADuM3070](#).

Table 3. Double Supply Terminal Function Descriptions

Terminal	Pin	Label	Description
P5	1	+5V IN	Side 1 5 V primary input supply
P6	1	GND	Side 1 ground reference
P7	1	+7.5V/6V	Side 2 7.5 V secondary isolated supply (regulated)
P8	1	GND ISO	Side 2 ground reference
P9	1	+15V/12V	Side 2 15 V secondary isolated supply (regulated)
P10	1	GND ISO	Side 2 ground reference

**TRANSFORMER SELECTION**

The EVAL-ADuM3070EBZ supports multiple transformer options. The double supply is equipped with a Halo TGSAD-290V6LF (T3) or a Coilcraft JA4650-BL (T4) 1:3 turns ratio transformer. The Coilcraft footprint is directly to the left of the Halo footprint (see the ADuM3070 data sheet for a details on transformer selection with the ADuM3070). Figure 12 and Figure 14 show the supply’s efficiency with a Coilcraft and a Halo transformer, respectively, at different switching frequencies.

**SWITCHING FREQUENCY OPTIONS**

The resistor connected from the ADuM3070 OC pin to ground sets the double supply switching frequency. Figure 4 shows the relationship between this resistance and the converter switching frequency. The EVAL-ADuM3070EBZ can be configured with 0 Ω, 0805 resistors to four different preset switching frequencies. Short-circuiting R26 sets R28 (300 kΩ) and R29 (150 kΩ) in parallel, and short-circuiting R27 sets R28 and R30 (100 kΩ) in parallel. Table 4 lists the switching frequencies that can be selected by short- or open-circuiting R26 and R27. The user can select a different switching frequency by removing R26 and R27 and then choosing R28 based on Figure 4. The board is configured for the 500 kHz setting by default. Figure 12 and Figure 14 show how the switching frequency affects the efficiency with either transformer installed. Figure 13 shows how temperature affects efficiency.

**Table 4. Switching Frequency Selection**

R26	R27	R <sub>oc</sub>	Switching Frequency
Open	Open	300 kΩ	200 kHz
0 Ω	Open	100 kΩ	500 kHz
Open	0 Ω	75 kΩ	700 kHz
0 Ω	0 Ω	50 kΩ	1 MHz

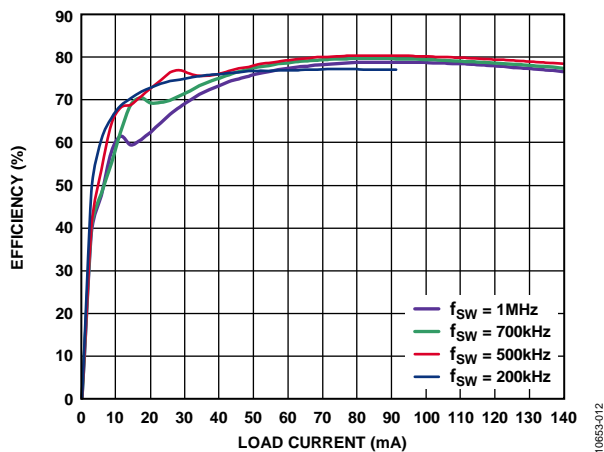

Figure 12. 5 V In to 15 V Out Efficiency with the 1:3 Coilcraft Transformer at Various Switching Frequencies

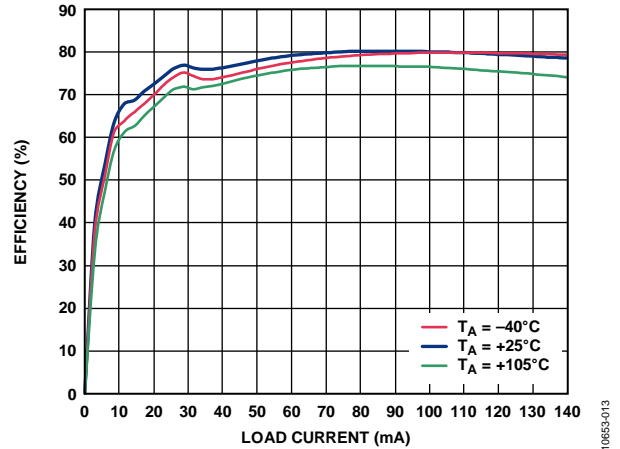

Figure 13. 5 V In to 15 V Out Efficiency with the 1:3 Coilcraft Transformer at 500 kHz and Various Temperatures

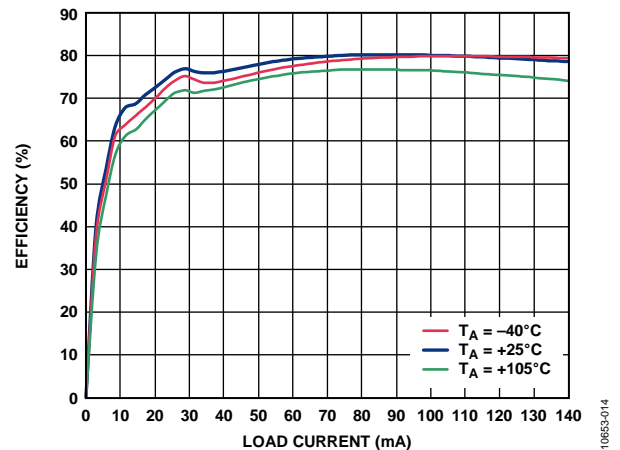

Figure 14. 5 V In to 15 V Out Efficiency with the 1:3 Halo Transformer at Various Switching Frequencies

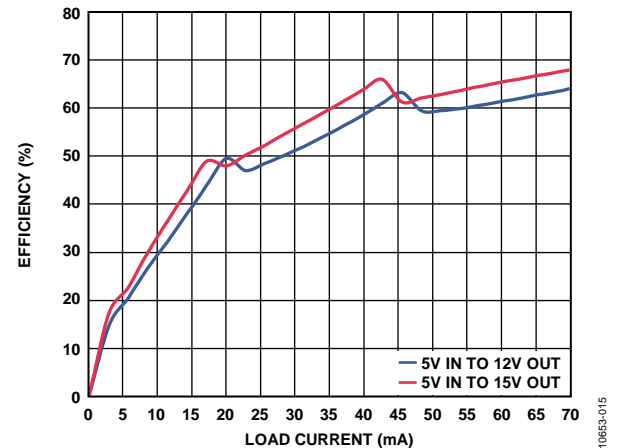

Figure 15. Double Supply Efficiency with the 1:5 Coilcraft Transformer for Different Output Options at 500 kHz

**OTHER SECONDARY ISOLATED SUPPLY CONFIGURATIONS**

The double supply can be configured for 12 V regulated and 6 V unregulated secondary isolated supplies by short-circuiting R17 with a 0 Ω resistor for R18. The regulated supply voltage is set by the fraction of it that is fed back to the ADuM3070 via the voltage divider comprising R16, R17, R32, and R18. The voltage at the feedback pin is 1.25 V. With R18 open-circuited, the ADuM3070 feedback voltage is approximately 1.25 V if VISO2 is 15 V. When R18 is short-circuited, the feedback voltage is approximately 1.25 V if VISO2 is 12 V (see the ADuM3070 data sheet for more details on setting the secondary isolated output supply voltage). Figure 15 shows the efficiency curves for both output settings at 500 kHz with the 1:5 Coilcraft transformer.

**Positive and Negative Outputs**

The double supply can be set up as a positive and negative ±15 V supply by changing the transformer to a turns ratio 1CT:5CT transformer (see the ADuM3070 data sheet for more information on these transformers). Other changes begin with removing the 0 Ω resistors from R24 and R22 and inserting them into R23 and R21. Short-circuiting R23 instead of R24 makes the 7.5 V/6 V P7

become the -15 V supply. Short-circuiting R21 instead of R22 connects the transformer center tap to the ground plane instead of the node where L3, C12, and C13 are connected. Figure 16 shows which resistors should be short-circuited and open-circuited for the double supply or positive and negative supply configurations. Note that the negative supply is unregulated. The positive and negative supplies can be set for ±12 V instead of ±15 V by short-circuiting R18.

Whereas the 15 V output can be regulated, the same problems with regulation can happen as described in the Powering V<sub>REG</sub> from the Unregulated 7.5 V Supply section. In addition, the -15 V supply can vary over a wide range because it is unregulated and influenced by the changes that happen on the 15 V output.

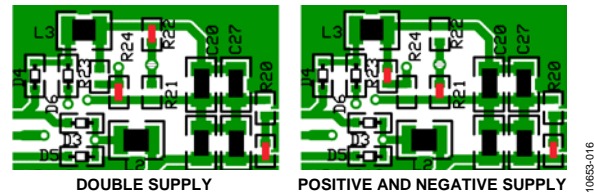

Figure 16. Double Supply Configuration with 0 Ω Resistors (Red)

**SCHEMATIC**

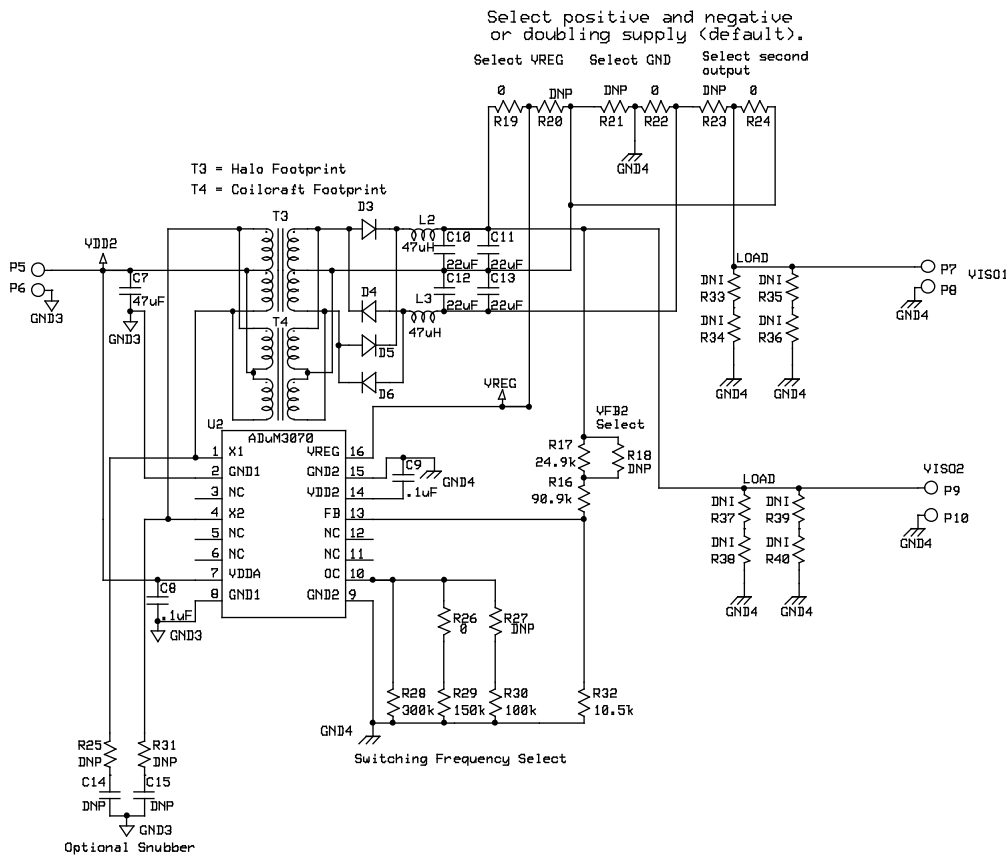

Figure 17. Double Supply Schematic



### EVALUATION BOARD LAYOUT

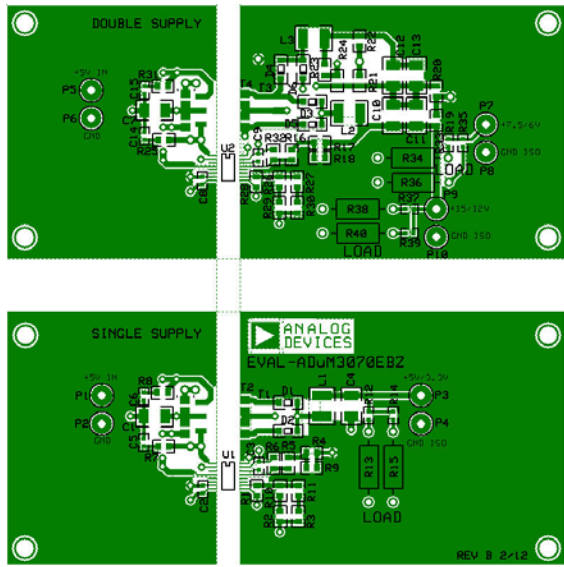

Figure 18. Top Layer: Power Fill

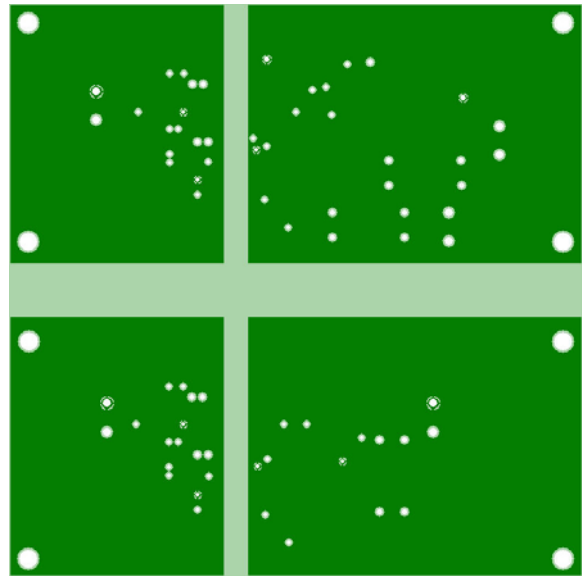

Figure 20. Layer 3: Power Plane

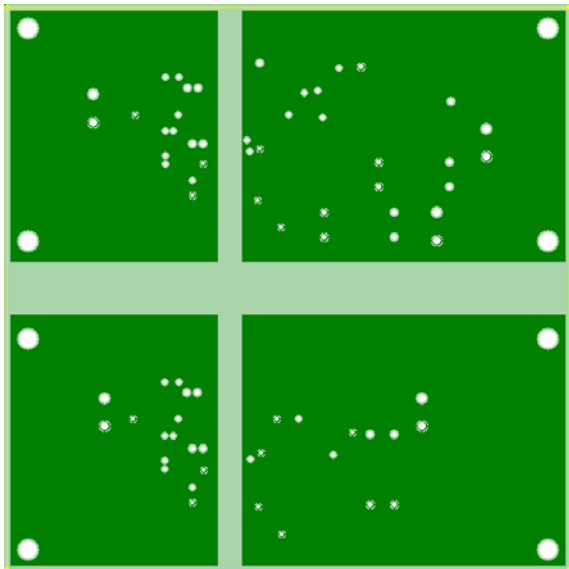

Figure 19. Layer 2: Ground Plane

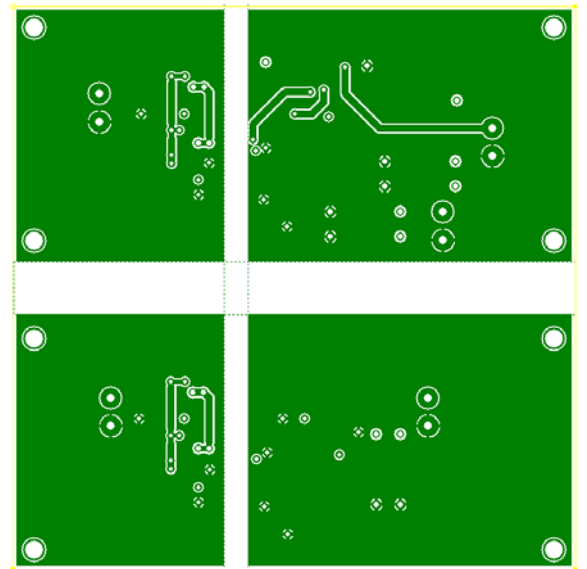

Figure 21. Bottom Layer: Ground Fill

## ORDERING INFORMATION

### BILL OF MATERIALS

Table 5.

Qty	Reference Designator	Description	Supplier/Part Number
5	P1, P3, P5, P7, P9	TP-104 series test point, black	Components Corp./TP-104-01-00
5	P2, P4, P6, P8, P10	TP-104 series test point, red	Components Corp./TP-104-01-02
2	U1, U2	ADuM3070	Analog Devices, Inc.
6	D1 to D6	Schottky barrier rectifier, 0.5 A, 40 V, SMD, SOD-123	ON Semi/MBR0540
1 <sup>1</sup>	T1	Transformer, 1:2 turns ratio, SMD	Halo/TGSAD-260V6LF
1 <sup>1</sup>	T2	Transformer, 1:2 turns ratio, SMD	Coilcraft/JA4631-BL
1 <sup>1</sup>	T3	Transformer, 1:3 turns ratio, SMD	Halo/TGSAD-290V6LF
1 <sup>1</sup>	T4	Transformer, 1:3 turns ratio, SMD	Coilcraft/JA4650-BL
4	C2, C3, C8, C9	Capacitor ceramic, X7R, SMD, 0603, 0.1 $\mu$ F	AVX/0603YC104KAT2A
3	C1, C4, C7	Capacitor ceramic, X7R, SMD, 1210, 47 $\mu$ F, 20%, 10 V	Murata/GRM32ER71A476KE15L
4	C10 to C13	Capacitor ceramic, X7R, SMD, 1210, 22 $\mu$ F, 20% 16 V	Murata/GRM32ER71C226KE18L
3	L1 to L3	Inductor, SMD 1212, 47 $\mu$ H, 20%, 1.25 $\Omega$	Murata/LQH3NPN470MM0
2	R1, R28	RES chip, SMD 0805, 300 k $\Omega$ , 1/8 W, 1%	Yageo/RC0805FR-07300KL
2	R2, R29	RES chip, SMD 0805, 150 k $\Omega$ , 1/8 W, 1%	Yageo/RC0805FR-07150KL
2	R3, R30	RES chip, SMD 0805, 100 k $\Omega$ , 1/8 W, 1%	Panasonic/ECG/ERJ-6ENF1003V
2	R6, R32	RES chip, SMD 0805, 10.5 k $\Omega$ , 1/8 W, 1%	Panasonic/ECG/ERJ-6ENF1052V
1	R4	RES chip, SMD 0805, 14.3 k $\Omega$ , 1/8 W, 1%	Panasonic/ECG/ERJ-6ENF1432V
1	R5	RES chip, SMD 0805, 17.4 k $\Omega$ , 1/8 W, 1%	Panasonic/ECG/ERJ-6ENF1742V
1	R17	RES chip, SMD 0805, 24.9 k $\Omega$ , 1/8 W, 1%	Panasonic/ECG/ERJ-6ENF2492V
1	R16	RES chip, SMD 0805, 90.9 k $\Omega$ , 1/8 W, 1%	Panasonic/ECG/ERJ-6ENF9092V
5	R19, R22, R24, R26, R10	RES chip, SMD 0805, 0 $\Omega$ , 1/8 W	Panasonic/ECG/ERJ-6GEY0R00V
0	R11 to R15, R18, R20, R21, R23, R25, R27, R31, R33 to R40, C5, C6, C14, C15	Not populated	N/A

<sup>1</sup> The board is populated with either Coilcraft or Halo transformers. Do not populate both T1 and T2 or T3 and T4.

**NOTES**

## NOTES

**ESD Caution**

**ESD (electrostatic discharge) sensitive device.** Charged devices and circuit boards can discharge without detection. Although this product features patented or proprietary protection circuitry, damage may occur on devices subjected to high energy ESD. Therefore, proper ESD precautions should be taken to avoid performance degradation or loss of functionality.

**Legal Terms and Conditions**

By using the evaluation board discussed herein (together with any tools, components documentation or support materials, the "Evaluation Board"), you are agreeing to be bound by the terms and conditions set forth below ("Agreement") unless you have purchased the Evaluation Board, in which case the Analog Devices Standard Terms and Conditions of Sale shall govern. Do not use the Evaluation Board until you have read and agreed to the Agreement. Your use of the Evaluation Board shall signify your acceptance of the Agreement. This Agreement is made by and between you ("Customer") and Analog Devices, Inc. ("ADI"), with its principal place of business at One Technology Way, Norwood, MA 02062, USA. Subject to the terms and conditions of the Agreement, ADI hereby grants to Customer a free, limited, personal, temporary, non-exclusive, non-sublicensable, non-transferable license to use the Evaluation Board FOR EVALUATION PURPOSES ONLY. Customer understands and agrees that the Evaluation Board is provided for the sole and exclusive purpose referenced above, and agrees not to use the Evaluation Board for any other purpose. Furthermore, the license granted is expressly made subject to the following additional limitations: Customer shall not (i) rent, lease, display, sell, transfer, assign, sublicense, or distribute the Evaluation Board; and (ii) permit any Third Party to access the Evaluation Board. As used herein, the term "Third Party" includes any entity other than ADI, Customer, their employees, affiliates and in-house consultants. The Evaluation Board is NOT sold to Customer; all rights not expressly granted herein, including ownership of the Evaluation Board, are reserved by ADI. CONFIDENTIALITY. This Agreement and the Evaluation Board shall all be considered the confidential and proprietary information of ADI. Customer may not disclose or transfer any portion of the Evaluation Board to any other party for any reason. Upon discontinuation of use of the Evaluation Board or termination of this Agreement, Customer agrees to promptly return the Evaluation Board to ADI. ADDITIONAL RESTRICTIONS. Customer may not disassemble, decompile or reverse engineer chips on the Evaluation Board. Customer shall inform ADI of any occurred damages or any modifications or alterations it makes to the Evaluation Board, including but not limited to soldering or any other activity that affects the material content of the Evaluation Board. Modifications to the Evaluation Board must comply with applicable law, including but not limited to the RoHS Directive. TERMINATION. ADI may terminate this Agreement at any time upon giving written notice to Customer. Customer agrees to return to ADI the Evaluation Board at that time. LIMITATION OF LIABILITY. THE EVALUATION BOARD PROVIDED HEREUNDER IS PROVIDED "AS IS" AND ADI MAKES NO WARRANTIES OR REPRESENTATIONS OF ANY KIND WITH RESPECT TO IT. ADI SPECIFICALLY DISCLAIMS ANY REPRESENTATIONS, ENDORSEMENTS, GUARANTEES, OR WARRANTIES, EXPRESS OR IMPLIED, RELATED TO THE EVALUATION BOARD INCLUDING, BUT NOT LIMITED TO, THE IMPLIED WARRANTY OF MERCHANTABILITY, TITLE, FITNESS FOR A PARTICULAR PURPOSE OR NONINFRINGEMENT OF INTELLECTUAL PROPERTY RIGHTS. IN NO EVENT WILL ADI AND ITS LICENSORS BE LIABLE FOR ANY INCIDENTAL, SPECIAL, INDIRECT, OR CONSEQUENTIAL DAMAGES RESULTING FROM CUSTOMER'S POSSESSION OR USE OF THE EVALUATION BOARD, INCLUDING BUT NOT LIMITED TO LOST PROFITS, DELAY COSTS, LABOR COSTS OR LOSS OF GOODWILL. ADI'S TOTAL LIABILITY FROM ANY AND ALL CAUSES SHALL BE LIMITED TO THE AMOUNT OF ONE HUNDRED US DOLLARS (\$100.00). EXPORT. Customer agrees that it will not directly or indirectly export the Evaluation Board to another country, and that it will comply with all applicable United States federal laws and regulations relating to exports. GOVERNING LAW. This Agreement shall be governed by and construed in accordance with the substantive laws of the Commonwealth of Massachusetts (excluding conflict of law rules). Any legal action regarding this Agreement will be heard in the state or federal courts having jurisdiction in Suffolk County, Massachusetts, and Customer hereby submits to the personal jurisdiction and venue of such courts. The United Nations Convention on Contracts for the International Sale of Goods shall not apply to this Agreement and is expressly disclaimed.