

General-purpose Operational Amplifiers / Comparators



TROPHY SERIES

Operational Amplifiers

LM358DR/PWR/DGKR, LM2904DR/PWR/DGKR/VQDR/VQPWR
LM324DR/PWR/KDR, LM2902DR/PER/KDR/KPWR/KVQDR/KVQPWR

No.11094EBT02

●Description

The Universal Standard family LM358 / 324 and LM2904 / 2902 monolithic ICs integrate two independent op-amp circuits and phase compensation capacitors on a single chip, feature high gain and low power consumption, and possess an operating voltage range between 3[V] and 32[V] (single power supply.)

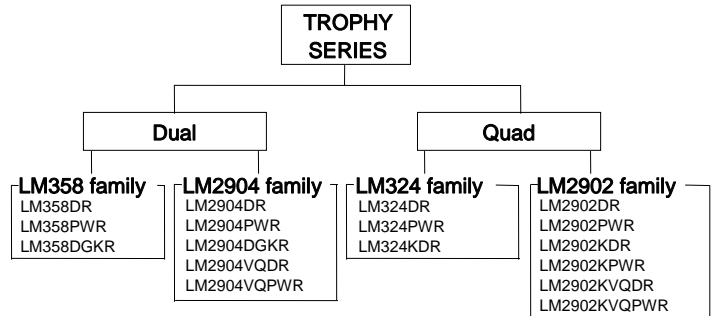

●Features

- 1) Operating temperature range
 Commercial Grade LM358/324 family : 0[°C] to + 70[°C]
 Extended Industrial Grade LM2904/2902 family : -40[°C] to +125[°C]
- 2) Wide operating voltage range
 +3[V] to +32[V] (single supply)
 ±1.5[V] to ±16[V] (dual supply)
- 3) Low supply current
- 4) Common-mode input voltage range, including ground
- 5) Differential input voltage range equal to maximum rated supply voltage
- 6) High large signal voltage gain
- 7) Wide output voltage range

●Pin Assignment

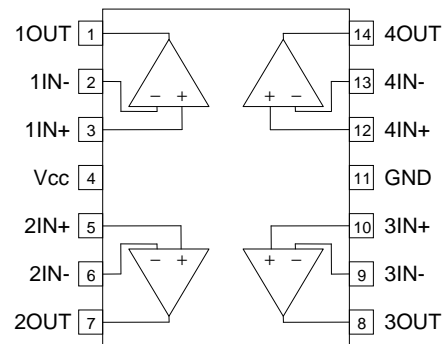
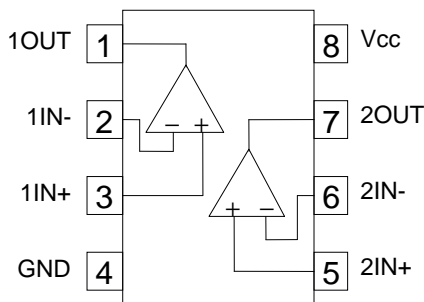

SOIC8
LM358DR
LM2904DR
LM2904VQDR

TSSOP8
LM358PWR
LM2904PWR
LM2904VQPWR

MSOP8/VSSOP8
LM358DGKR
LM2904DGKR

SOIC14
LM324DR
LM324KDR
LM2902DR
LM2902KDR
LM2902KVQDR

TSSOP14
LM324PWR
LM2902PWR
LM2902KPWR
LM2902KVQPWR

●Absolute Maximum Ratings (Ta=25[°C])

Parameter	Symbol	Ratings						Unit
		LM358 family	LM324 family	LM2904 family	LM2902 family	LM2904V family	LM2902V family	
Supply Voltage	Vcc-GND	+32		+26		+32		V
Operating Temperature Range	Topr	0 to +70			-40 to +125			°C
Storage Temperature Range	Tstg	-65 to +150						°C
Input Common-mode Voltage	VICM	-0.3 to +32		-0.3 to +26		-0.3 to +32		V
Maximum Junction Temperature	Tjmax	150						°C

●Electric Characteristics

OLM358,LM324 family (Unless otherwise specified, Vcc=+5[V])

Parameter	Symbol	Temperature range	Limits						Unit	Conditions	Fig. No
			LM358 family			LM324 family					
			Min.	Typ.	Max.	Min.	Typ.	Max.			
Input Offset Voltage (*1)	VIO	25°C	—	3	7	—	3	7	mV	VO=1.4[V] VIC=VICR(min) Vcc=5[V] to 30[V]	98
		Full range	—	—	9	—	—	9			
Input Offset Voltage Drift	αVIO	—	—	7	—	—	—	—	μV/°C	—	—
Input Offset Current (*1)	IIO	25°C	—	2	50	—	2	50	nA	VO=1.4[V]	98
		Full range	—	—	150	—	—	150			
Input Offset Current Drift	αIIO	—	—	10	—	—	—	—	pA/°C	—	—
Input Bias Current (*1)	IIB	25°C	—	20	250	—	20	250	nA	VO=1.4[V]	98
		Full range	—	—	500	—	—	500			
Input Common-mode Voltage Range	VICR	25°C	0	—	Vcc-1.5	—	—	Vcc-1.5	V	Vcc=5[V] to 30[V]	98
		Full range	0	—	Vcc-2.0	—	—	Vcc-2.0			
High Level Output Voltage	VOH	25°C	Vcc-1.5	—	—	Vcc-1.5	—	—	V	RL ≥ 2[kΩ]	99
		Full range	27	28	—	27	28	—		Vcc=30[V], RL ≥ 10[kΩ]	
Low Level Output Voltage	VOL	Full range	—	5	20	—	5	20	mV	RL ≤ 10[kΩ]	98
Large Signal Voltage Gain	AVD	25°C	25	100	—	25	100	—	V/mV	Vcc=15[V] VO=1[V] to 11[V] RL ≥ 2[kΩ]	98
Common-mode Rejection Ratio	CMRR	25°C	65	80	—	65	80	—	dB	Vcc=5[V] to 30[V], VIC=VICR(min)	98
Supply-Voltage rejection ratio	KSVR	25°C	65	100	—	65	100	—	dB	Vcc=5[V] to 30[V]	98
Cross-talk Attenuation	VO1/VO2	25°C	—	120	—	—	120	—	dB	f=1[kHz] to 20[kHz]	101
Output Current (*2)	Source	25°C	20	30	—	20	30	—	mA	Vcc=15[V], VO=0[V] VID=1[V]	99
		Full range	10	—	—	10	—	—			
	Sink	25°C	10	20	—	10	20	—	mA	Vcc=15[V], VO=0[V] VID=-1[V]	
		Full range	2	—	—	2	—	—			
Supply Current (All Amps)	ICC	25°C	12	30	—	12	30	—	μA	VO=200[mV], VID=-1[V]	
		Full range	—	0.7	1.2	—	0.7	1.2		mA	VO=2.5[V], No Load
Full range	—	1	2	—	1.4	3	—	Vcc=30[V], VO=0.5[V] No Load			
Slew Rate at Unity-Gain	SR	25°C	—	0.3	—	—	0.5	—	V/μs	RL=1[MΩ], CL=30[pF] VI=±10[V] Vcc=15[V], GND=-15[V] (reference to Fig100)	99
Unity Gain Bandwidth	B1	25°C	—	0.7	—	—	1.2	—	MHz	RL=1[MΩ], CL=20[pF] Vcc=15[V], GND=-15[V] (reference to Fig99)	99
Equivalent Input Noise Voltage	Vn	25°C	—	40	—	—	35	—	nV/√Hz	Vcc=15[V], GND=-15[V] RS=100[Ω], VI=0[V] f=1[kHz](reference to Fig99)	99

(*1) Absolute value

(*2) Under high temperature, consider the power dissipation of IC when selecting the output current.

When the output terminal is continuously shorted, the output current reduces the temperature inside the IC by flushing.

OLM2904,LM2902 family (Unless otherwise specified, Vcc=+5[V])

Parameter	Symbol	Temperature range	Limits						Unit	Conditions	Fig. No	
			LM2904 family			LM2902 family						
			Min.	Typ.	Max.	Min.	Typ.	Max.				
Input Offset Voltage (*3)	VIO	25°C	—	3	7	—	3	7	mV	VO=1.4[V],VIC=VICR(min) Vcc=5[V] to MAX(*5)	98	
		Full range	—	—	10	—	—	10				
Input Offset Voltage Drift	αVIO	—	—	7	—	—	7	—	μV/°C	—	—	
Input Offset Current (*3)	LM2904 LM2902(*5)	IIO	25°C	—	2	50	—	2	50	nA	VO=1.4[V]	98
			Full range	—	—	300	—	—	300			
	LM2904V LM2902V(*5)	25°C	—	2	50	—	2	50				
		Full range	—	—	150	—	—	150				
Input Offset Current Drift	αIIO	—	—	10	—	—	10	—	pA/°C	—	—	
Input Bias Current (*3)	IIB	25°C	—	20	250	—	20	250	nA	VO=1.4[V]	98	
		Full range	—	—	500	—	—	500				
Input Common-mode Voltage Range	VICR	25°C	—	—	Vcc-1.5	—	—	Vcc-1.5	V	Vcc=5[V] to MAX(*5)	98	
		Full range	—	—	Vcc-2.0	—	—	Vcc-2.0				
High Level Output Voltage	LM2904 LM2902(*5) LM2904V LM2902V(*5)	VOH	25°C	Vcc-1.5	—	—	Vcc-1.5	—	—	V	RL ≥ 10[kΩ]	99
			Full range	23	24	—	23	24	—		Vcc=MAX(*5),RL ≥ 10[kΩ]	
			Full range	27	28	—	27	—	—		Vcc=MAX(*5),RL ≥ 10[kΩ]	
Low Level Output Voltage	VOL	Full range	—	5	20	—	5	20	mV	RL ≤ 10[kΩ]	99	
Large Signal Voltage Gain	AVD	25°C	25	100	—	25	100	—	V/mV	Vcc=15[V],VO=1[V] to 11[V] RL ≥ 2[kΩ]	98	
Common-mode Rejection Ratio	LM2904 LM2902(*5) LM2902V(*5)	CMRR	25°C	50	80	—	50	80	—	dB	Vcc=5[V] to MAX(*5) VIC=VICR(min)	98
			25°C	65	80	—	60	80	—			
Supply Voltage Rejection Ratio	LM2904 LM2904V M2902(*5) LM2902V(*5)	KSVR	25°C	65	100	—	50	100	—	dB	Vcc=5[V] to MAX(*5)	98
				—	—	—	60	100	—			
Cross-talk Attenuation	VO1/VO2	25°C	—	120	—	—	120	—	dB	f=1[kHz] to 20[kHz]	101	
Output Current (*4)	Source	25°C	20	30	—	20	30	60	mA	Vcc=15[V],VO=0[V] VID=1[V]	99	
		Full range	10	—	—	10	—	—				
	Sink	25°C	10	20	—	10	20	—	mA	Vcc=15[V],VO=0[V] VID=-1[V]		
		Full range	2	—	—	2	—	—				
	LM2904 LM2902(*5) LM2904V LM2902V(*5)	Io	25°C	—	30	—	—	30	—	μA		VO=200[mV],VID=-1[V]
			25°C	12	40	—	12	40	—			
Supply Current (All Amps)	ICC	Full range	—	0.7	1.2	—	0.7	1.2	mA	VO=2.5[V],No Load	99	
		Full range	—	1	2	—	1.4	3		Vcc=MAX(*5),VO=0.5[V] No Load		
Slew Rate at Unity Gain	SR	25°C	—	0.3	—	—	0.5	—	V/μs	RL=1[MΩ],CL=30[pF], VI=±10[V] Vcc=15[V],GND=-15[V] (reference to Fig100)	99	
Unity-Gain Bandwidth	B1	25°C	—	0.7	—	—	1.2	—	MHz	RL=1[MΩ],CL=20[pF] Vcc=15[V],GND=-15[V] (reference to Fig99)	99	
Equivalent Input Noise Voltage	Vn	25°C	—	40	—	—	35	—	nV/√Hz	Vcc=15[V],GND=-15[V] RS=100[Ω]VI=0[V] f=1[kHz], (reference to Fig99)	99	

(*3) Absolute value

(*4) Under high temperature, consider the power dissipation of the IC when selecting the output current.

When the output terminal is continuously shorted the output current is reduced to lower the temperature inside the IC.

(*5) The maximum supply voltage is 26V for the LM2904DR, LM2904PW, LM2904PWR, and LM2904DQKR

The maximum supply voltage is 32V for the LM2904VQDR and LM2904VQPWR

●Reference Data LM358 family

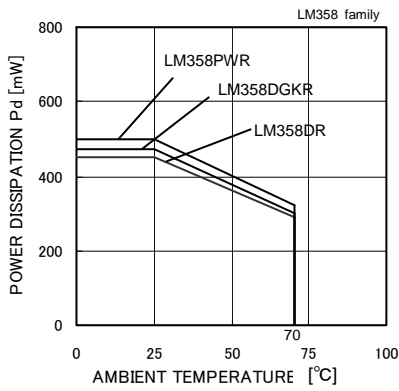

Fig. 1

Derating Curve

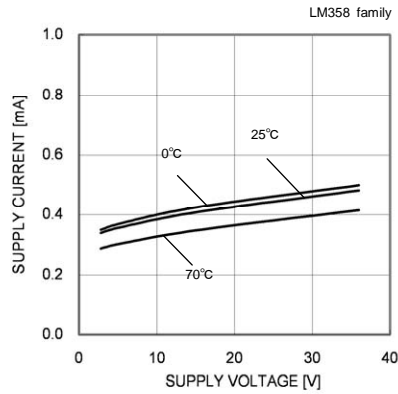

Fig. 2

Supply Current - Supply Voltage

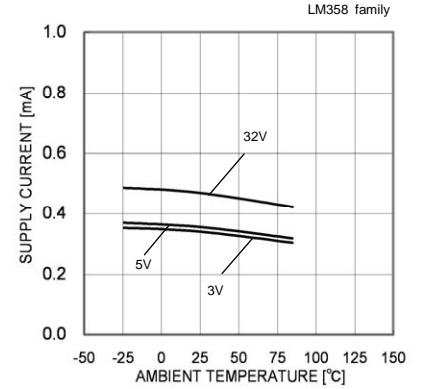

Fig. 3

Supply Current - Ambient Temperature

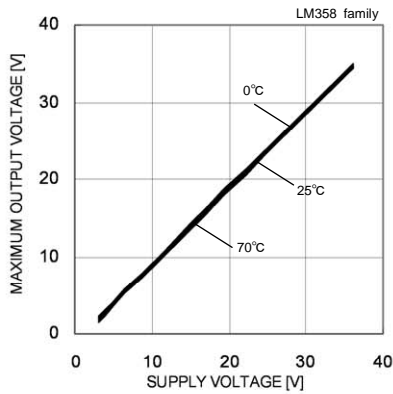

Fig. 4

Maximum Output Voltage - Supply Voltage (RL=10[kΩ])

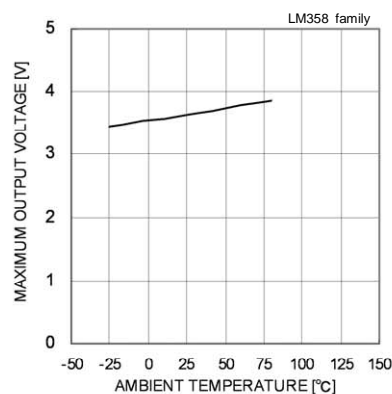

Fig. 5

Maximum Output Voltage - Ambient Temperature (VCC=5[V], RL=2[kΩ])

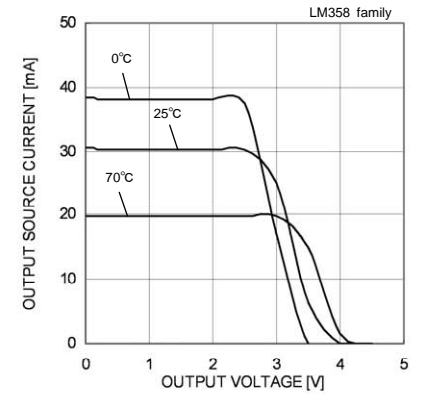

Fig. 6

Output Source Current - Output Voltage (VCC=5[V])

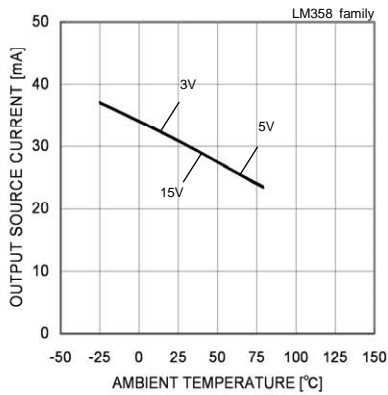

Fig. 7

Output Source Current - Ambient Temperature (VOUT=0[V])

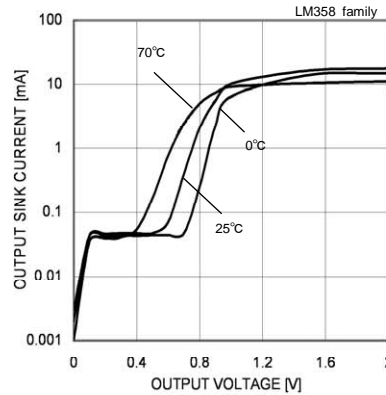

Fig. 8

Output Sink Current - Output Voltage (VCC=5[V])

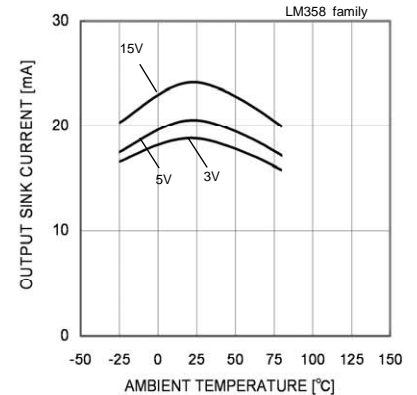

Fig. 9

Output Sink Current - Ambient Temperature (VOUT=VCC)

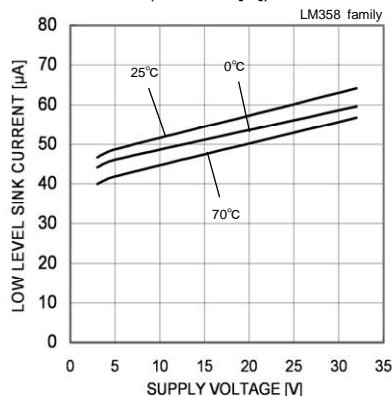

Fig. 10

Low Level Sink Current - Supply Voltage (VOUT=0.2[V])

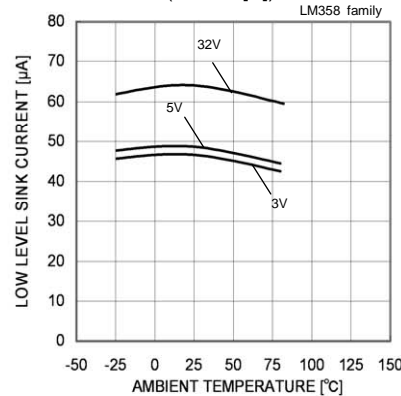

Fig. 11

Low Level Sink Current - Ambient Temperature (VOUT=0.2[V])

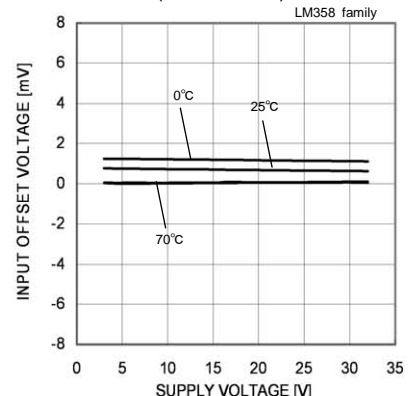

Fig. 12

Input Offset Voltage - Supply Voltage (Vicm=0[V], VOUT=1.4[V])

(*)The data above is ability value of sample, it is not guaranteed.

●Reference Data LM358 family

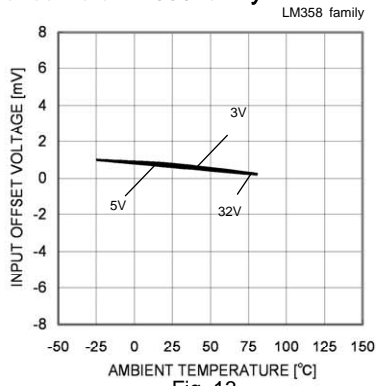

Fig. 13

Input Offset Voltage – Ambient Temperature
 (Vicm=0[V], VOUT=1.4[V])

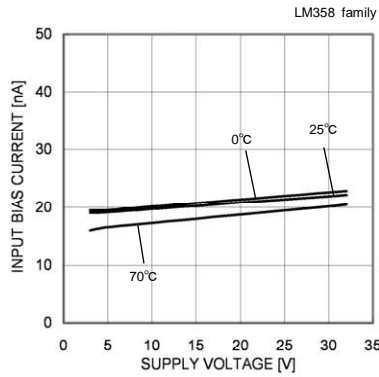

Fig. 14

Input Bias Current – Supply Voltage
 (Vicm=0[V], VOUT=1.4[V])

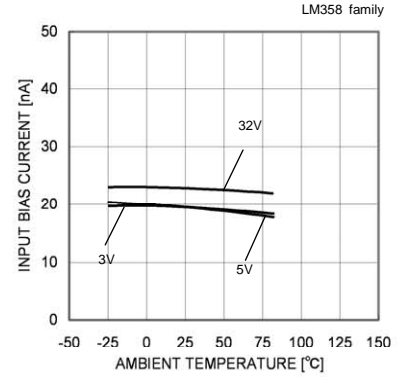

Fig. 15

Input Bias Current – Ambient Temperature
 (Vicm=0[V], VOUT=1.4[V])

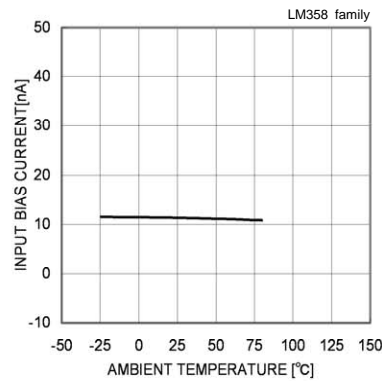

Fig. 16

Input Bias Current – Ambient Temperature
 (VCC=30[V], Vicm=28[V], VOUT=1.4[V])

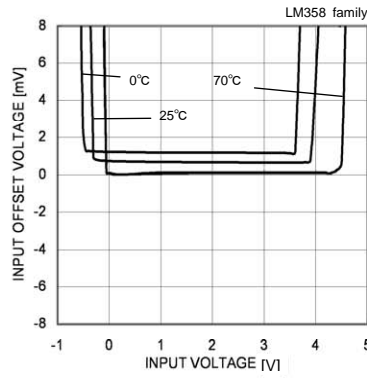

Fig. 17

Input Offset Voltage – Common Mode Input Voltage
 (VCC=5[V])

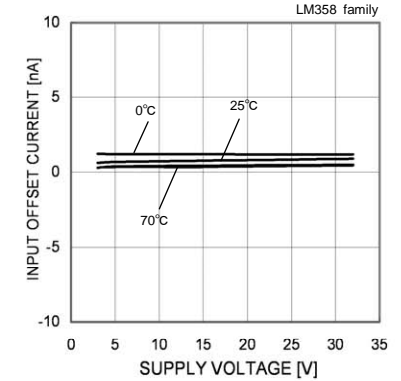

Fig. 18

Input Offset Current – Supply Voltage
 (Vicm=0[V], VOUT=1.4[V])

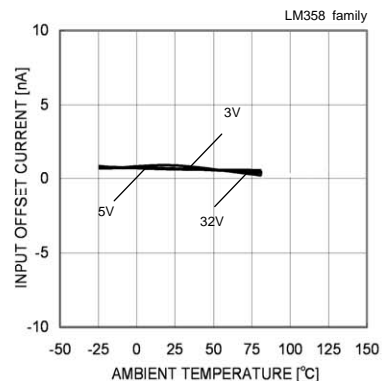

Fig. 19

Input Offset Current – Ambient Temperature
 (Vicm=0[V], VOUT=1.4[V])

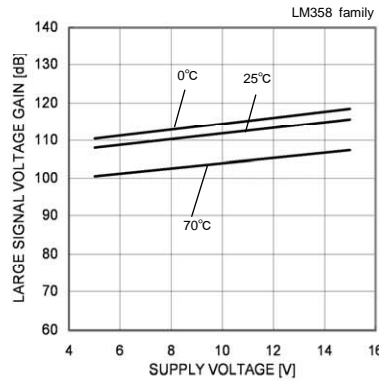

Fig. 20

Large Signal Voltage Gain – Supply Voltage
 (RL=2[kΩ])

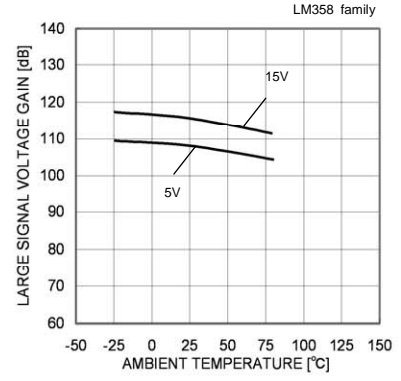

Fig. 21

Large Signal Voltage Gain
 – Ambient Temperature
 (RL=2[kΩ])

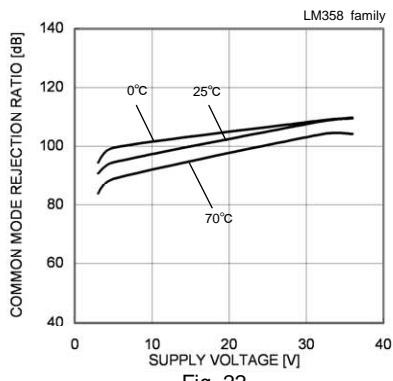

Fig. 22

Common Mode Rejection Ratio
 – Supply Voltage

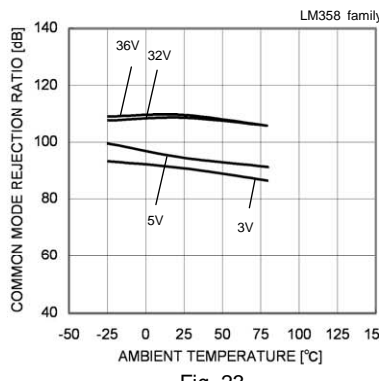

Fig. 23

Common Mode Rejection Ratio
 – Ambient Temperature

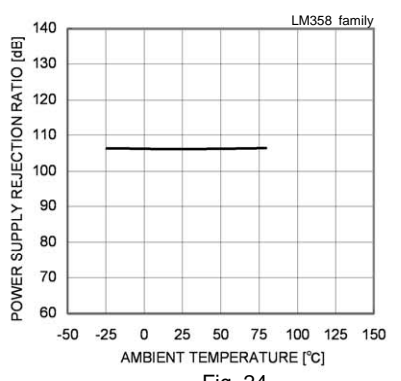

Fig. 24

Power Supply Rejection Ratio
 – Ambient Temperature

(*)The data above is ability value of sample, it is not guaranteed.

●Reference Data LM324 family

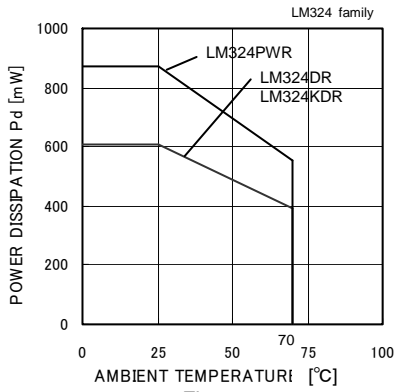

Fig. 25

Derating Curve

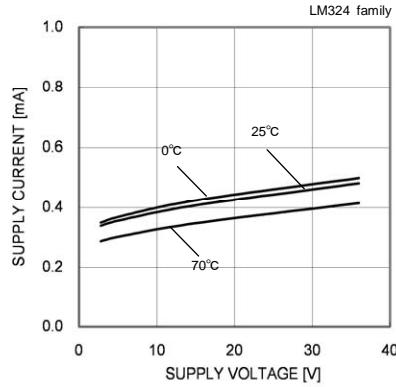

Fig. 26

Supply Current - Supply Voltage

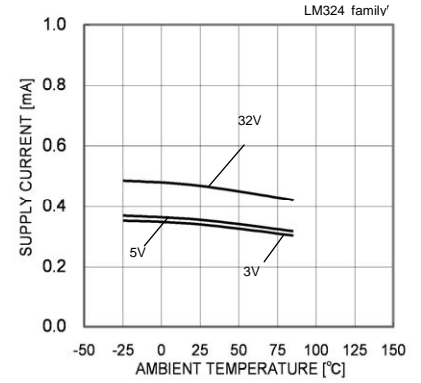

Fig. 27

Supply Current - Ambient Temperature

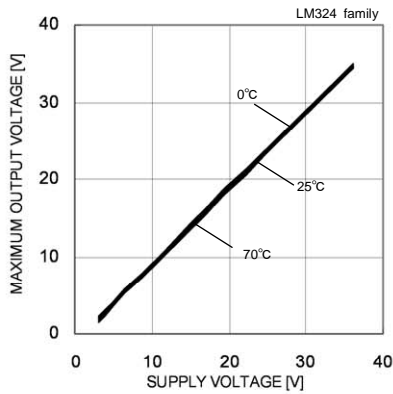

Fig. 28

Maximum Output Voltage - Supply Voltage
($R_L=10[k\Omega]$)

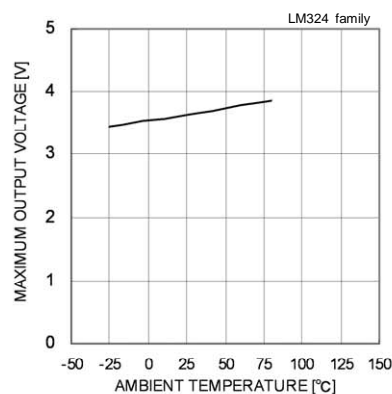

Fig. 29

Maximum Output Voltage - Ambient Temperature
($V_{CC}=5[V], R_L=2[k\Omega]$)

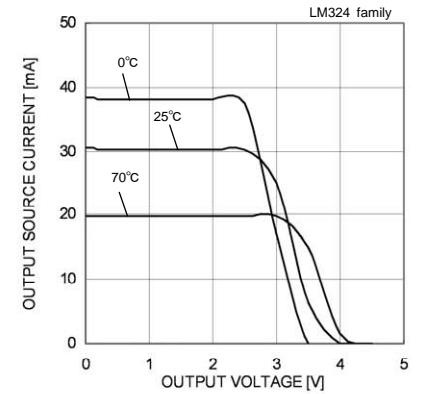

Fig. 30

Output Source Current - Output Voltage
($V_{CC}=5[V]$)

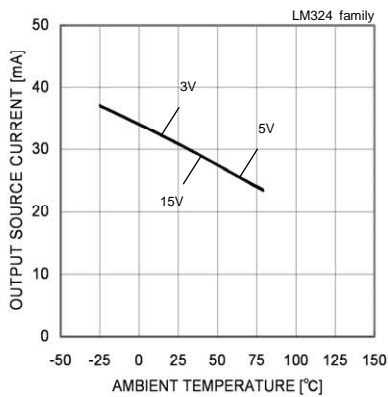

Fig. 31

Output Source Current - Ambient Temperature
($V_{OUT}=0[V]$)

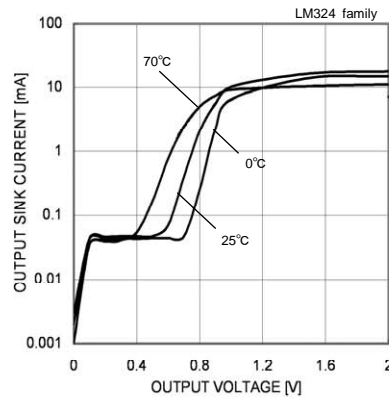

Fig. 32

Output Sink Current - Output Voltage
($V_{CC}=5[V]$)

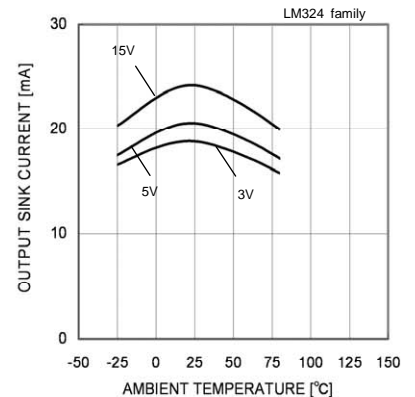

Fig. 33

Output Sink Current - Ambient Temperature
($V_{OUT}=V_{CC}$)

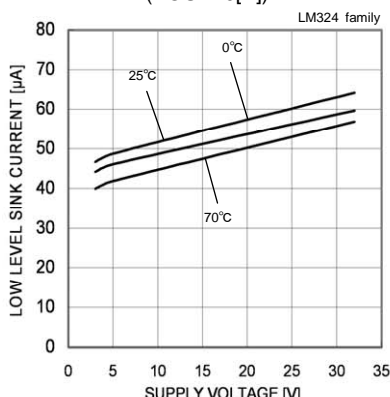

Fig. 34

Low Level Sink Current - Supply Voltage
($V_{OUT}=0.2[V]$)

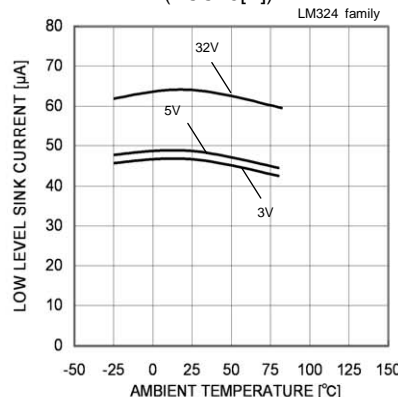

Fig. 35

Low Level Sink Current - Ambient Temperature
($V_{OUT}=0.2[V]$)

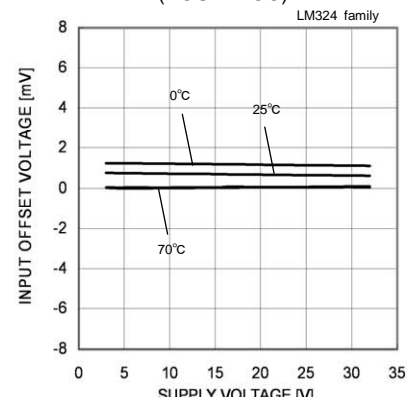

Fig. 36

Input Offset Voltage - Supply Voltage
($V_{icm}=0[V], V_{OUT}=1.4[V]$)

(*)The data above is ability value of sample, it is not guaranteed.

●Reference Data LM324 family

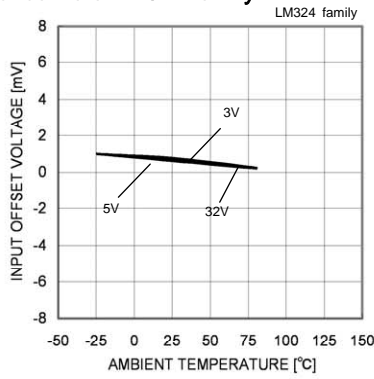

Fig. 37
 Input Offset Voltage – Ambient Temperature
 (Vicm=0[V], VOUT=1.4[V])

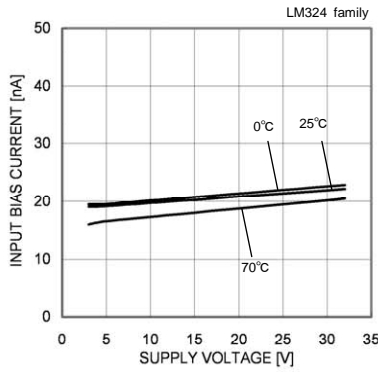

Fig. 38
 Input Bias Current – Supply Voltage
 (Vicm=0[V], VOUT=1.4[V])

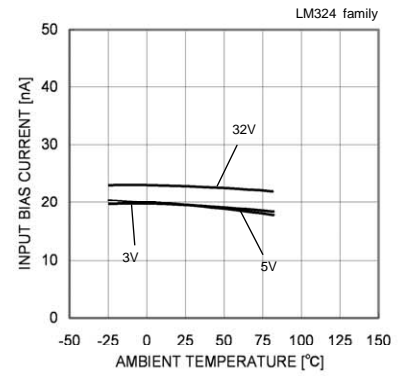

Fig. 39
 Input Bias Current – Ambient Temperature
 (Vicm=0[V], VOUT=1.4[V])

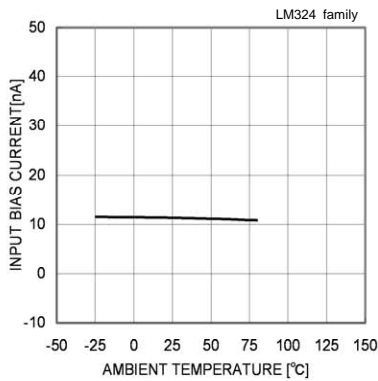

Fig. 40
 Input Bias Current – Ambient Temperature
 (VCC=30[V], Vicm=28[V], VOUT=1.4[V])

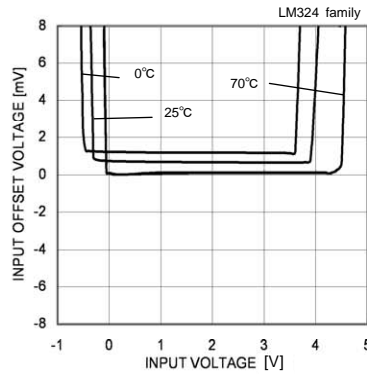

Fig. 41
 Input Offset Voltage – Common Mode Input Voltage
 (VCC=5[V])

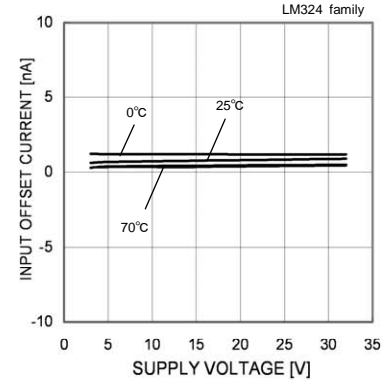

Fig. 42
 Input Offset Current – Supply Voltage
 (Vicm=0[V], VOUT=1.4[V])

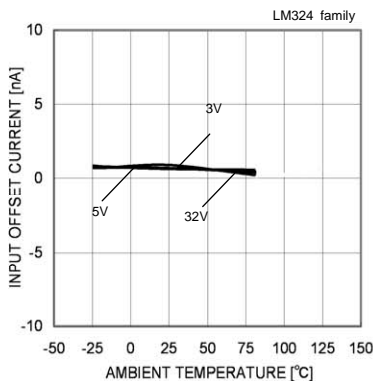

Fig. 43
 Input Offset Current – Ambient Temperature
 (Vicm=0[V], VOUT=1.4[V])

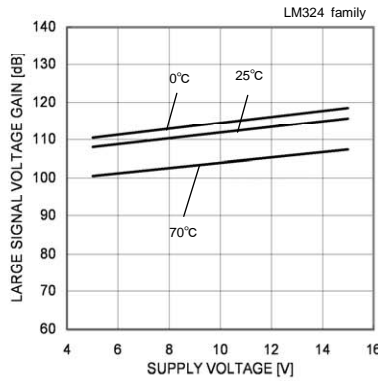

Fig. 44
 Large Signal Voltage Gain – Supply Voltage
 (RL=2[kΩ])

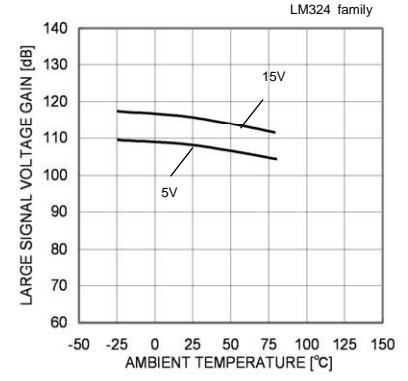

Fig. 45
 Large Signal Voltage Gain – Ambient Temperature
 (RL=2[kΩ])

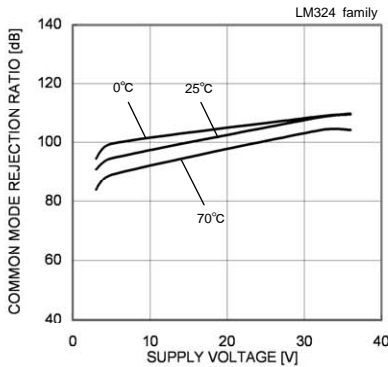

Fig. 46
 Common Mode Rejection Ratio – Supply Voltage

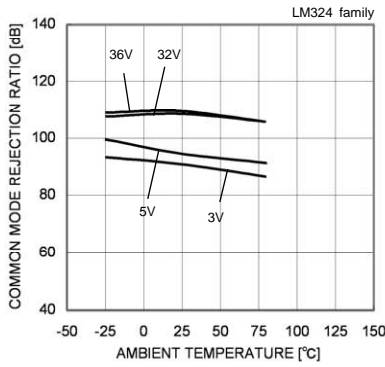

Fig. 47
 Common Mode Rejection Ratio – Ambient Temperature

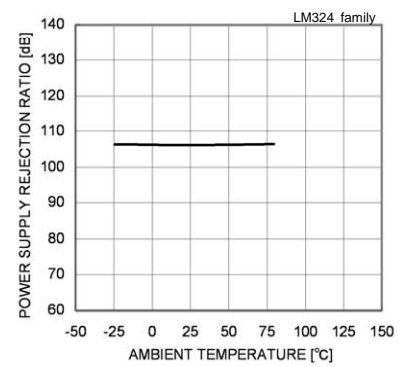

Fig. 48
 Power Supply Rejection Ratio – Ambient Temperature

(*)The data above is ability value of sample, it is not guaranteed.

●Reference Data LM2904 family

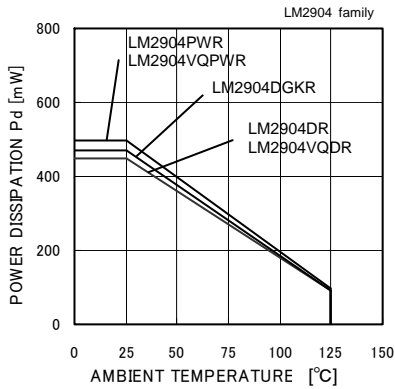

Fig. 49

Derating Curve

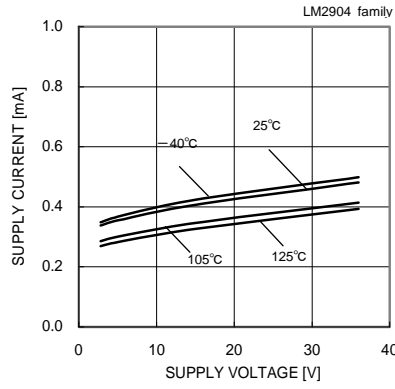

Fig. 50

Supply Current - Supply Voltage

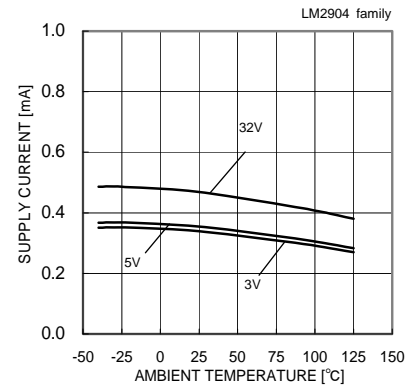

Fig. 51

Supply Current - Ambient Temperature

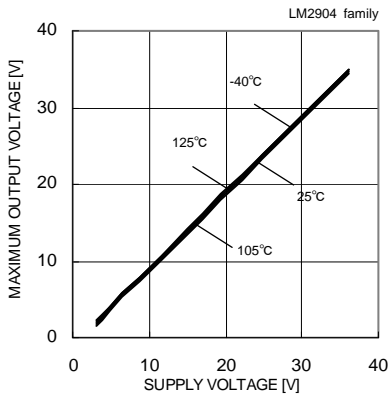

Fig. 52

Maximum Output Voltage - Supply Voltage (RL=10[kΩ])

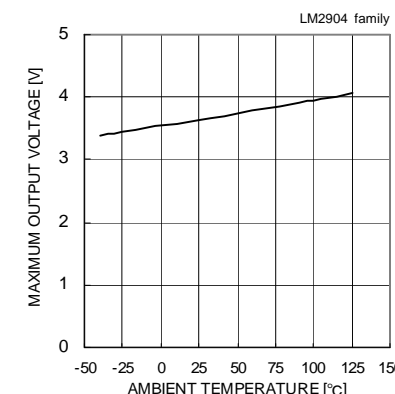

Fig. 53

Maximum Output Voltage - Ambient Temperature (VCC=5[V], RL=2[kΩ])

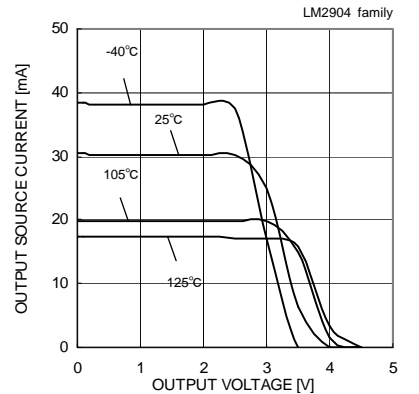

Fig. 54

Output Source Current - Output Voltage (VCC=5[V])

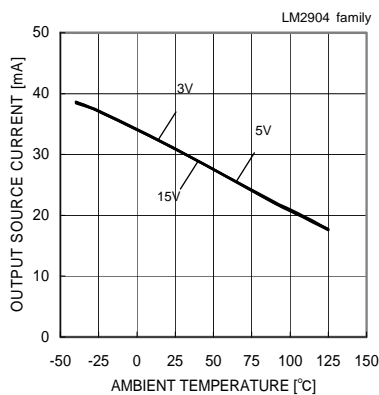

Fig. 55

Output Source Current - Ambient Temperature (VOUT=0[V])

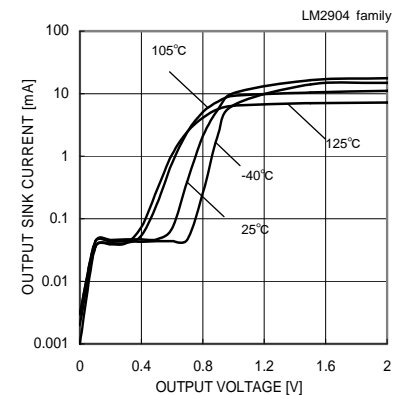

Fig. 56

Output Sink Current - Output Voltage (VCC=5[V])

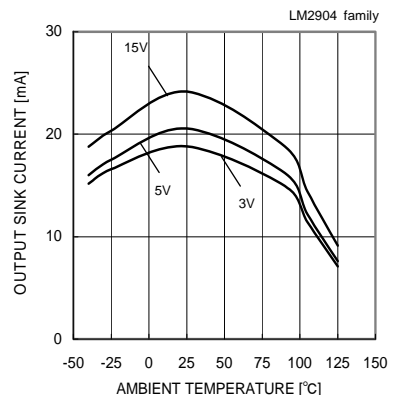

Fig. 57

Output Sink Current - Ambient Temperature (VOUT=VCC)

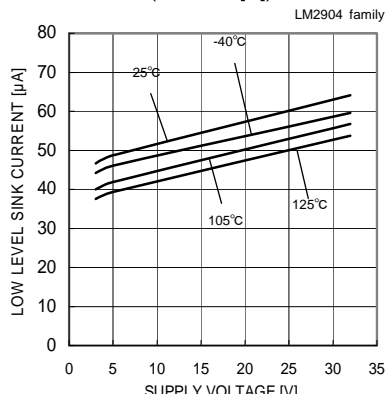

Fig. 58

Low Level Sink Current - Supply Voltage (VOUT=0.2[V])

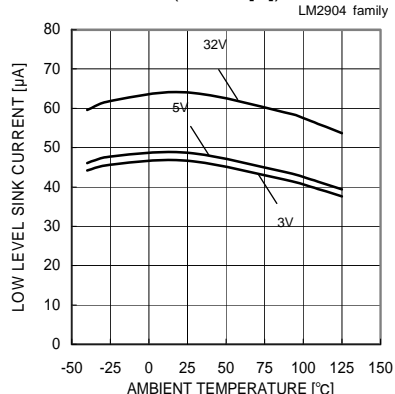

Fig. 59

Low Level Sink Current - Ambient Temperature (VOUT=0.2[V])

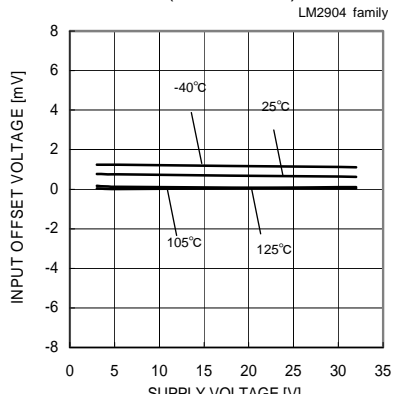

Fig. 60

Input Offset Voltage - Supply Voltage (Vicm=0[V], VOUT=1.4[V])

(*)The data above is ability value of sample, it is not guaranteed.

●Reference Data LM2904 family

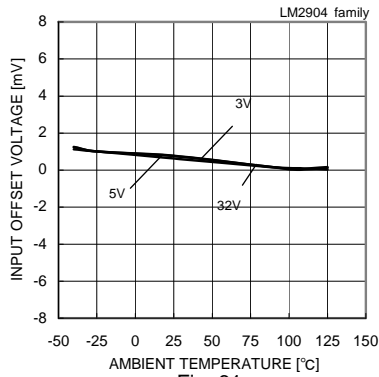

Fig. 61
 Input Offset Voltage – Ambient Temperature
 (Vicm=0[V], VOUT=1.4[V])

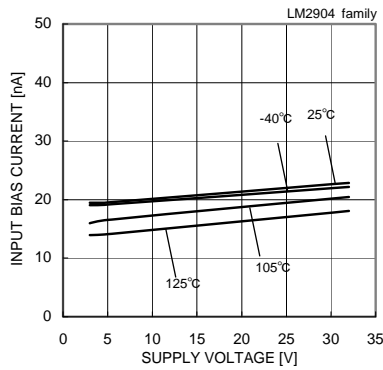

Fig. 62
 Input Bias Current – Supply Voltage
 (Vicm=0[V], VOUT=1.4[V])

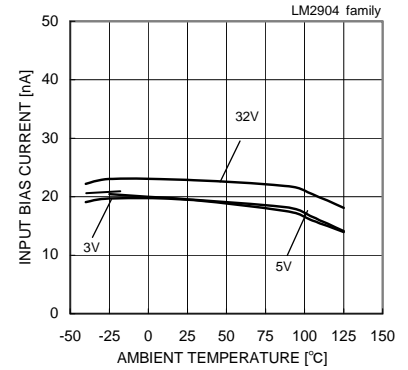

Fig. 63
 Input Bias Current – Ambient Temperature
 (Vicm=0[V], VOUT=1.4[V])

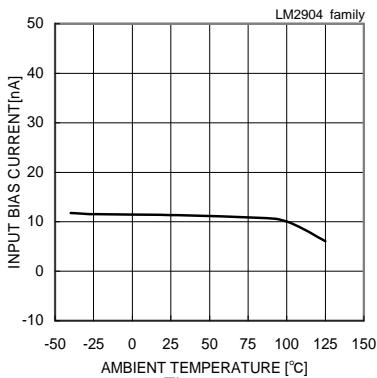

Fig. 64
 Input Bias Current – Ambient Temperature
 (VCC=30[V], Vicm=28[V], VOUT=1.4[V])

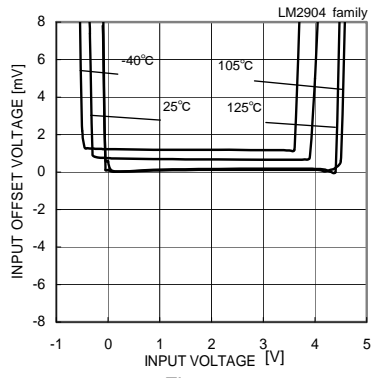

Fig. 65
 Input Offset Voltage – Common Mode Input Voltage
 (VCC=5[V])

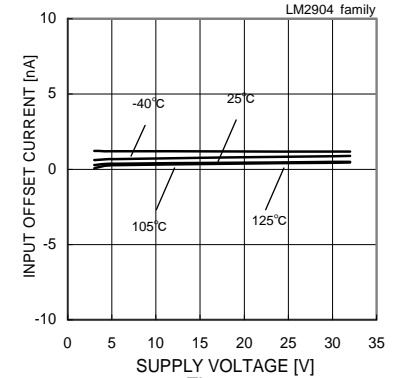

Fig. 66
 Input Offset Current – Supply Voltage
 (Vicm=0[V], VOUT=1.4[V])

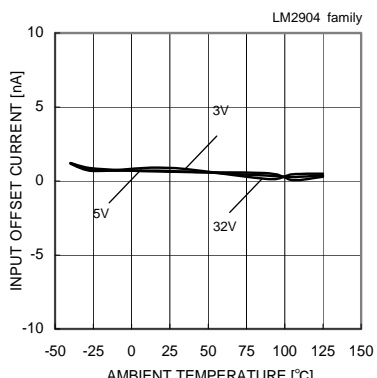

Fig. 67
 Input Offset Current – Ambient Temperature
 (Vicm=0[V], VOUT=1.4[V])

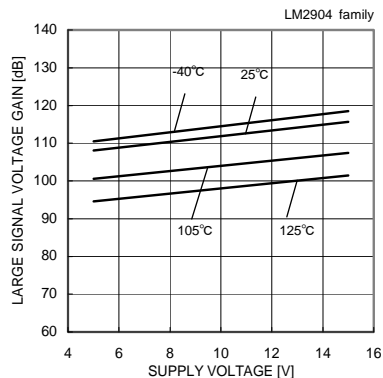

Fig. 68
 Large Signal Voltage Gain – Supply Voltage
 (RL=2[kΩ])

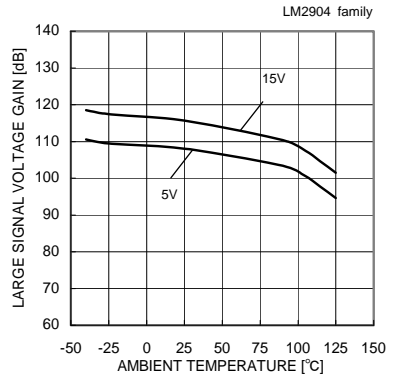

Fig. 69
 Large Signal Voltage Gain
 – Ambient Temperature
 (RL=2[kΩ])

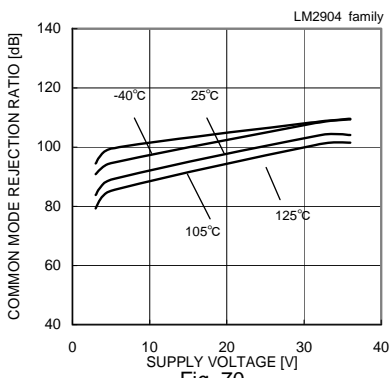

Fig. 70
 Common Mode Rejection Ratio
 – Supply Voltage

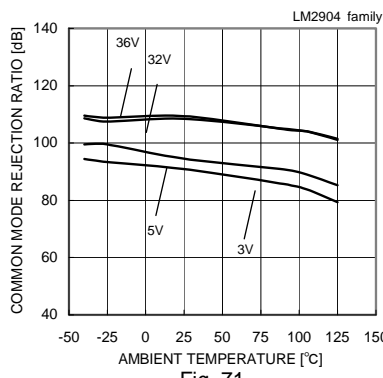

Fig. 71
 Common Mode Rejection Ratio
 – Ambient Temperature

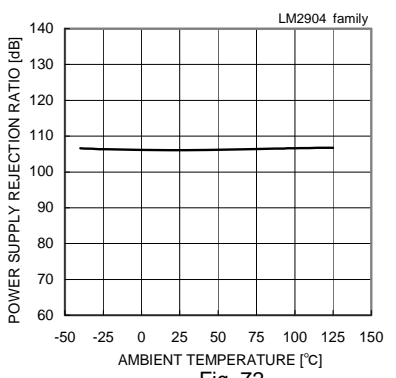

Fig. 72
 Power Supply Rejection Ratio
 – Ambient Temperature

(*The data above is ability value of sample, it is not guaranteed.)

●Reference Data LM2902 family

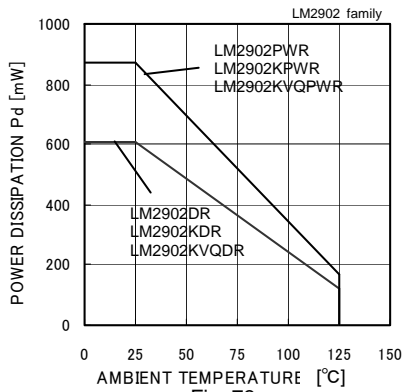

Fig. 73
 Derating Curve

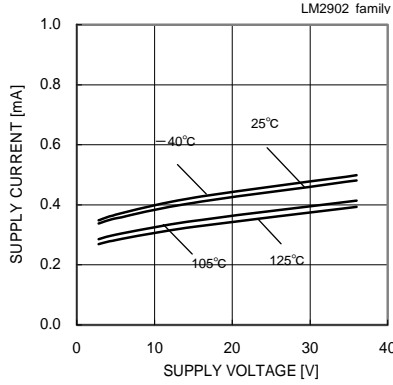

Fig. 74
 Supply Current - Supply Voltage

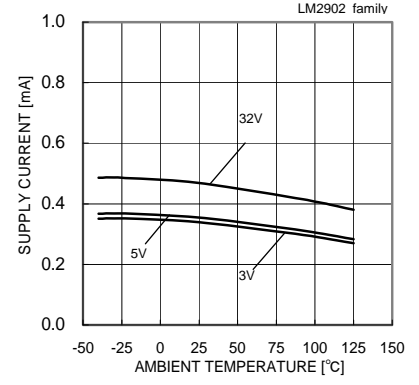

Fig. 75
 Supply Current - Ambient Temperature

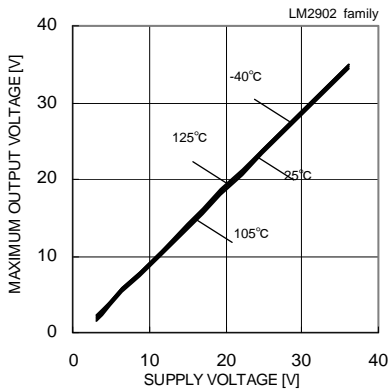

Fig. 76
 Maximum Output Voltage - Supply Voltage
 (RL=10[kΩ])

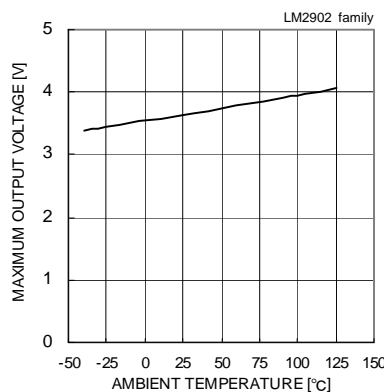

Fig. 77
 Maximum Output Voltage - Ambient Temperature
 (VCC=5[V], RL=2[kΩ])

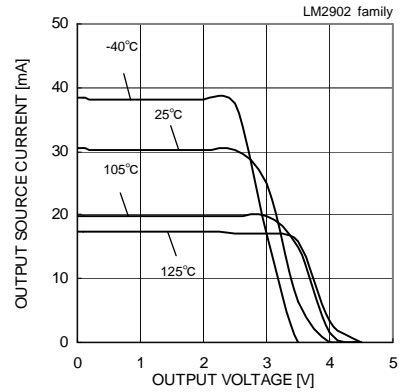

Fig. 78
 Output Source Current - Output Voltage
 (VCC=5[V])

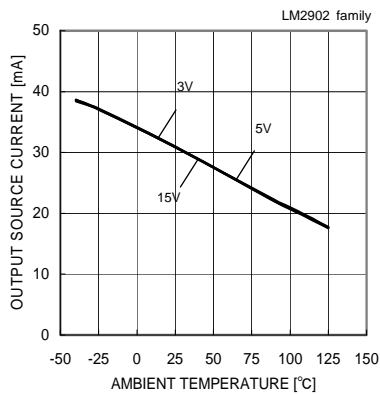

Fig. 79
 Output Source Current - Ambient Temperature
 (VOUT=0[V])

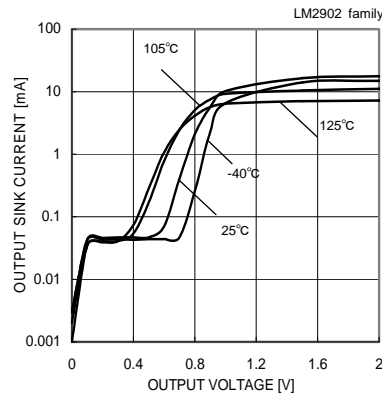

Fig. 80
 Output Sink Current - Output Voltage
 (VCC=5[V])

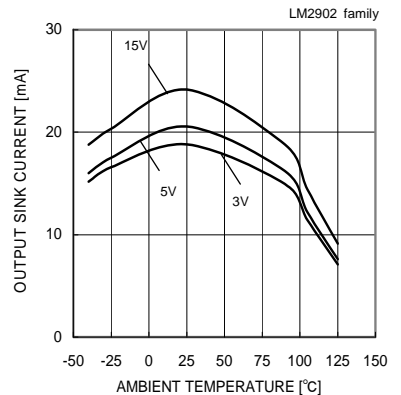

Fig. 81
 Output Sink Current - Ambient Temperature
 (VOUT=VCC)

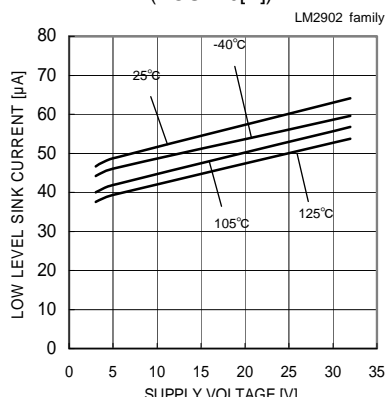

Fig. 82
 Low Level Sink Current - Supply Voltage
 (VOUT=0.2[V])

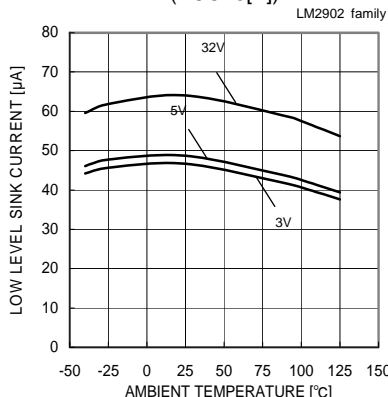

Fig. 83
 Low Level Sink Current - Ambient Temperature
 (VOUT=0.2[V])

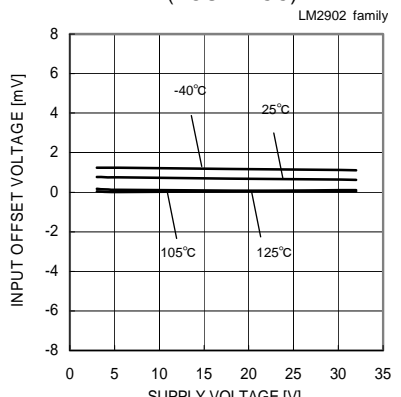

Fig. 84
 Input Offset Voltage - Supply Voltage
 (Vicm=0[V], VOUT=1.4[V])

(*The data above is ability value of sample, it is not guaranteed.)

●Reference Data LM2902 family

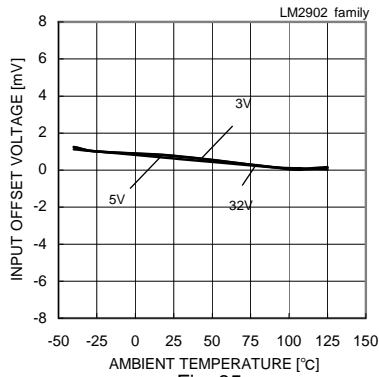

Fig. 85
 Input Offset Voltage – Ambient Temperature
 (Vicm=0[V], VOUT=1.4[V])

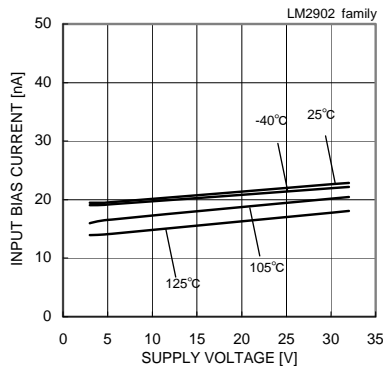

Fig. 86
 Input Bias Current – Supply Voltage
 (Vicm=0[V], VOUT=1.4[V])

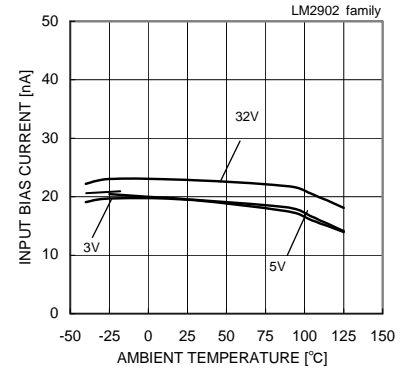

Fig. 87
 Input Bias Current – Ambient Temperature
 (Vicm=0[V], VOUT=1.4[V])

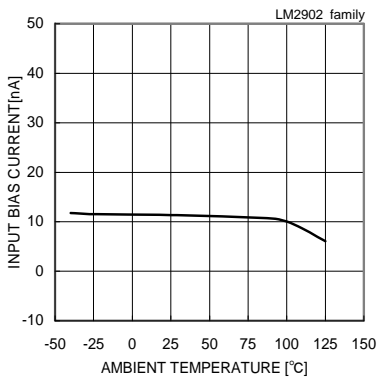

Fig. 88
 Input Bias Current – Ambient Temperature
 (VCC=30[V], Vicm=28[V], VOUT=1.4[V])

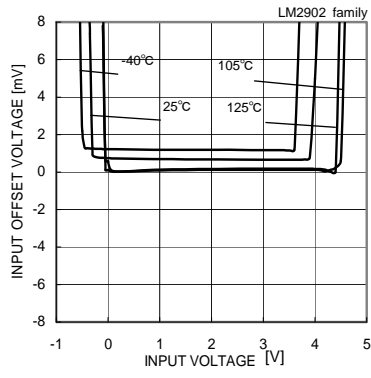

Fig. 89
 Input Offset Voltage – Common Mode Input Voltage
 (VCC=5[V])

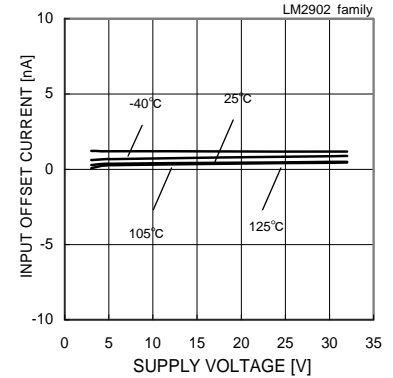

Fig. 90
 Input Offset Current – Supply Voltage
 (Vicm=0[V], VOUT=1.4[V])

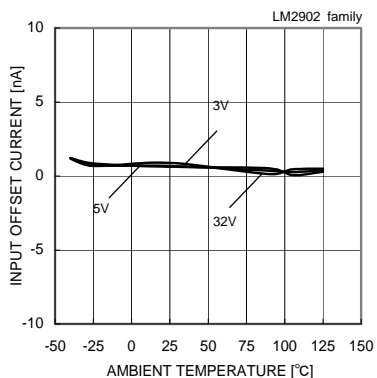

Fig. 91
 Input Offset Current – Ambient Temperature
 (Vicm=0[V], VOUT=1.4[V])

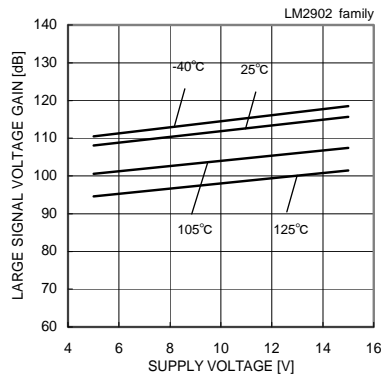

Fig. 92
 Large Signal Voltage Gain – Supply Voltage
 (RL=2[kΩ])

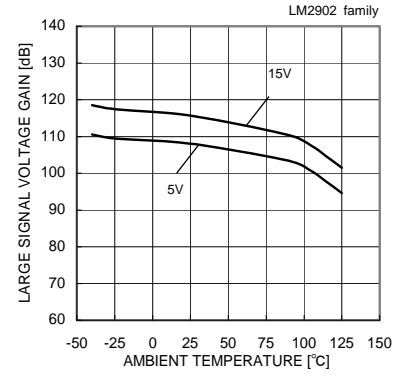

Fig. 93
 Large Signal Voltage Gain
 – Ambient Temperature
 (RL=2[kΩ])

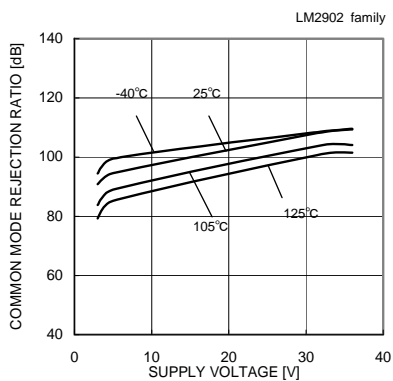

Fig. 94
 Common Mode Rejection Ratio
 – Supply Voltage

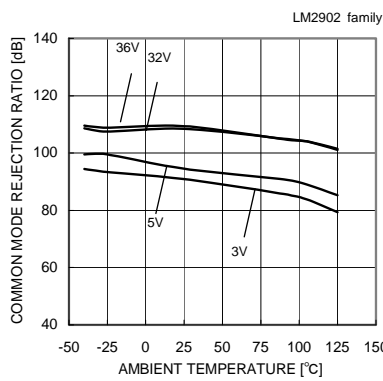

Fig. 95
 Common Mode Rejection Ratio
 – Ambient Temperature

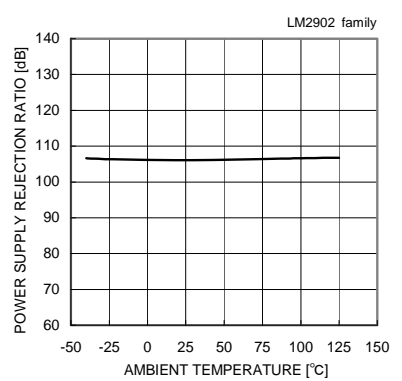

Fig. 96
 Power Supply Rejection Ratio
 – Ambient Temperature

(*)The data above is ability value of sample, it is not guaranteed.

●Circuit Diagram

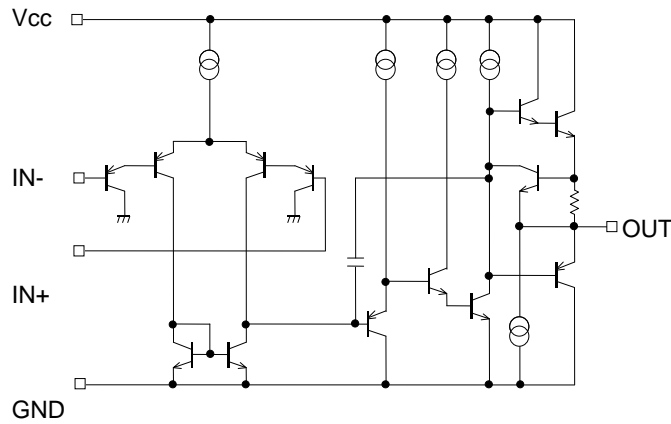

Fig.97 Circuit Diagram (each Op-Amp)

●Measurement Circuit 1 NULL Method Measurement Condition

Vcc,GND,EK,VICR Unit:[V]

Measurement item	VF	S1	S2	S3	LM358/LM324 family				LM2904/LM2902 family				Calculation
					Vcc	GND	EK	VICR	Vcc	GND	EK	VICR	
Input Offset Voltage	VF1	ON	ON	OFF	5 to 30	0	- 1.4	0	5 to 30	0	- 1.4	0	1
Input Offset Current	VF2	OFF	OFF	OFF	5	0	- 1.4	0	5	0	- 1.4	0	2
Input Bias Current	VF3	OFF	ON	OFF	5	0	- 1.4	0	5	0	- 1.4	0	3
	VF4	ON	OFF		5	0	- 1.4	0	5	0	- 1.4	0	
Large Signal Voltage Gain	VF5	ON	ON	ON	15	0	- 1.4	0	15	0	- 1.4	0	4
	VF6				15	0	-11.4	0	15	0	-11.4	0	
Common-mode Rejection Ratio	VF7	ON	ON	OFF	5	0	- 1.4	0	5	0	- 1.4	0	5
	VF8				5	0	- 1.4	3.5	5	0	- 1.4	3.5	
Supply Voltage Rejection Ratio	VF9	ON	ON	OFF	5	0	- 1.4	0	5	0	- 1.4	0	6
	VF10				30	0	- 1.4	0	30	0	- 1.4	0	

—Calculation—

1.Input Offset Voltage (VIO)

$$V_{io} = \frac{|VF1|}{1 + R_f/R_s} [V]$$

2. Input offset current (IIO)

$$I_{io} = \frac{|VF2 - VF1|}{R_i(1 + R_f/R_s)} [A]$$

3.Input Bias Current (IIB)

$$I_b = \frac{|VF4 - VF3|}{2 \times R_i(1 + R_f/R_s)} [A]$$

4.Large Signal Voltage Gain (AVD)

$$AV = 20 \times \text{Log} \frac{10 \times (1 + R_f/R_s)}{|VF6 - VF5|} [dB]$$

5.Common-mode rejection ratio (CMRR)

$$CMRR = 20 \times \text{Log} \frac{3.5 \times (1 + R_f/R_s)}{|VF8 - VF7|} [dB]$$

6.Supply Voltage rejection ratio (KSVR)

$$PSRR = 20 \times \text{Log} \frac{\Delta V_{cc} \times (1 + R_f/R_s)}{VF_{10} - VF_9} [dB]$$

ΔVcc=25V

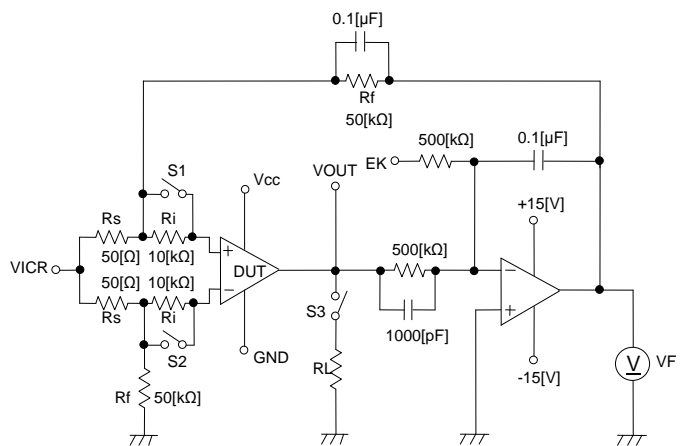

Fig.98 Measurement Circuit 1 (each Op-Amp)

● Measurement Circuit 2: Switch Condition

SW No.	SW 1	SW 2	SW 3	SW 4	SW 5	SW 6	SW 7	SW 8	SW 9	SW 10	SW 11	SW 12	SW 13	SW 14	SW 15
Supply Current	OFF	OFF	OFF	ON	OFF	OFF	ON	OFF	OFF	OFF	OFF	OFF	OFF	OFF	OFF
High Level Output Voltage	OFF	OFF	ON	OFF	OFF	OFF	ON	OFF	OFF	ON	OFF	OFF	OFF	ON	OFF
Low Level Output Voltage	OFF	OFF	ON	OFF	OFF	OFF	ON	OFF	OFF	OFF	OFF	OFF	OFF	ON	OFF
Output Source Current	OFF	OFF	ON	OFF	OFF	OFF	ON	OFF	OFF	OFF	OFF	OFF	OFF	OFF	ON
Output Sink Current	OFF	OFF	ON	OFF	OFF	OFF	ON	OFF	OFF	OFF	OFF	OFF	OFF	OFF	ON
Slew Rate	OFF	OFF	OFF	ON	OFF	OFF	OFF	OFF	ON	ON	ON	OFF	OFF	OFF	OFF
Unity-gain Bandwidth Product	OFF	ON	OFF	OFF	OFF	ON	ON	OFF	OFF	ON	ON	OFF	OFF	OFF	OFF
Equivalent Input Noise Voltage	ON	OFF	OFF	OFF	ON	OFF	ON	OFF	OFF	OFF	OFF	ON	OFF	OFF	OFF

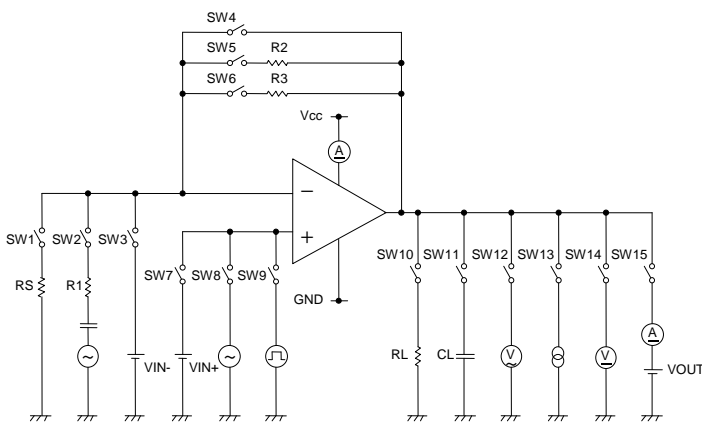

Fig.99 Measurement Circuit 2 (each Op-Amp)

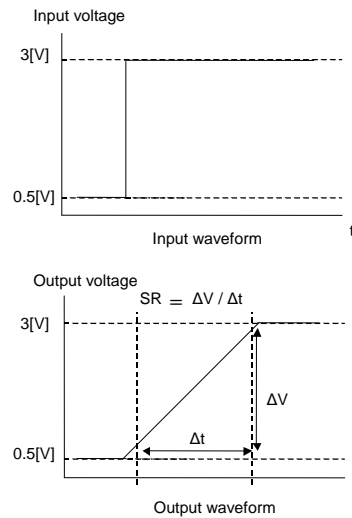

Fig.100 Slew Rate Input Waveform

● Measurement Circuit 3: Cross-talk Attenuation

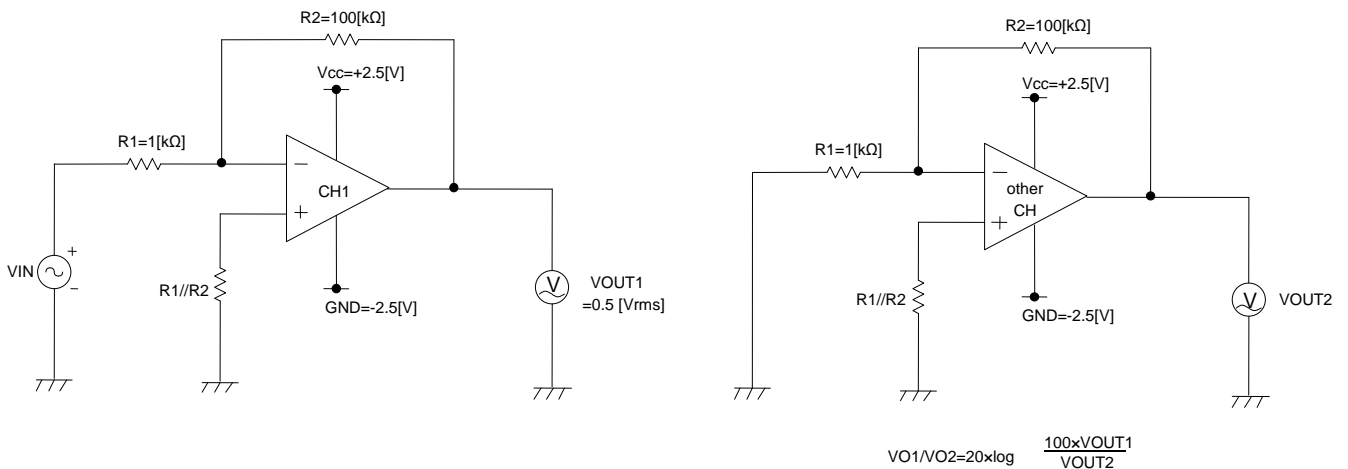

Fig.101 Measurement Circuit 3

●Description of Electrical Characteristics

Described below are descriptions of the relevant electrical terms

Please note that item names, symbols and their meaning may differ from those on another manufacturer's documents.

1. Absolute maximum ratings

The absolute maximum ratings are values that should never be exceeded, since doing so may result in deterioration of characteristics or damage to the part itself as well as peripheral components.

1.1 Power supply voltage (V_{CC}/GND)

Expresses the maximum voltage that can be supplied between the positive and negative power supply terminals without causing deterioration of characteristics or destruction of the internal circuitry.

1.2 Differential input voltage (V_{ID})

Indicates the maximum voltage that can be supplied between the non-inverting and inverting terminals without damaging the IC.

1.3 Input common-mode voltage range (V_{ICR})

Signifies the maximum voltage that can be supplied to the non-inverting and inverting terminals without causing deterioration of the electrical characteristics or damage to the IC itself. Normal operation is not guaranteed within the input common-mode voltage range of the maximum ratings – use within the input common-mode voltage range of the electrical characteristics instead.

1.4 Operating temperature range and storage temperature range (T_{opr} , T_{stg})

The operating temperature range indicates the temperature range within which the IC can operate. The higher the ambient temperature, the lower the power consumption of the IC. The storage temperature range denotes the range of temperatures the IC can be stored under without causing excessive deterioration of the electrical characteristics.

1.5 Power dissipation (P_d)

Indicates the power that can be consumed by a specific mounted board at ambient temperature (25°C). For packaged products, P_d is determined by the maximum junction temperature and the thermal resistance.

2. Electric characteristics

2.1 Input offset voltage (V_{IO})

Signifies the voltage difference between the non-inverting and inverting terminals. It can be thought of as the input voltage difference required for setting the output voltage to 0V.

2.2 Input offset voltage drift (αV_{IO})

Denotes the ratio of the input offset voltage fluctuation to the ambient temperature fluctuation.

2.3 Input offset current (I_{IO})

Indicates the difference of the input bias current between the non-inverting and inverting terminals.

2.4 Input offset current drift (αI_{IO})

Signifies the ratio of the input offset current fluctuation to the ambient temperature fluctuation.

2.5 Input bias current (I_{IB})

Denotes the current that flows into or out of the input terminal, it is defined by the average of the input bias current at the non-inverting terminal and the input bias current at the inverting terminal.

2.6 Circuit current (I_{CC})

Indicates the current of the IC itself that flows under specific conditions and during no-load steady state.

2.7 High level output voltage/low level output voltage (V_{OH}/V_{OL})

Signifying the voltage range that can be output by under specific load conditions, it is in general divided into high level output voltage and low level output voltage. High level output voltage indicates the upper limit of the output voltage, while low level output voltage the lower limit.

2.8 Differential voltage amplification (AVD)

The amplifying rate (gain) of the output voltage against the voltage difference between non-inverting and inverting terminals, it is (normally) the amplifying rate (gain) with respect to DC voltage.

$AVD = (\text{output voltage fluctuation}) / (\text{input offset fluctuation})$

2.9 Input common-mode voltage range (V_{ICR})

Indicates the input voltage range under which the IC operates normally.

2.10 Common-mode rejection ratio (CMRR)

Signifies the ratio of fluctuation of the input offset voltage when the in-phase input voltage is changed (DC fluctuation).

$CMRR = (\text{change in input common-mode voltage}) / (\text{input offset fluctuation})$

2.11 Power supply rejection ratio (KSVR)

Denotes the ratio of fluctuation of the input offset voltage when the supply voltage is changed (DC fluctuation).

$KSVR = (\text{change in power supply voltage}) / (\text{input offset fluctuation})$

2.12 Output source current/ output sink current (I_{OH}/I_{OL})

The maximum current that can be output under specific output conditions, it is divided into output source current and output sink current. The output source current indicates the current flowing out of IC, and the output sink current the current flowing into the IC.

2.13 Cross talk attenuation ($VO1/VO2$)

Expresses the amount of fluctuation in the input offset voltage or output voltage with respect to the change in the output voltage of a driven channel.

2.14 Slew rate at unity gain (SR)

Indicates the time fluctuation ratio of the output voltage when an input step signal is supplied.

2.15 Unity gain bandwidth (B_1)

The product of the specified signal frequency and the gain of the op-amp at such frequency, it gives the approximate value of the frequency where the gain of the op-amp is 1 (maximum frequency, unity gain frequency).

● Derating Curves

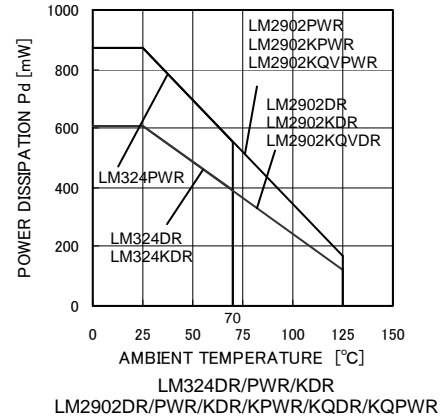
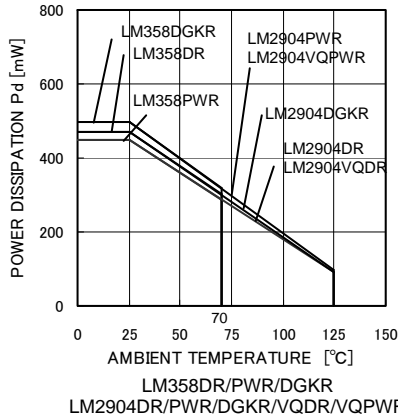

Power Dissipation

Package	Pd[W]	θ_{ja} [°C/W]
SOIC8 (*8)	450	3.6
TSSOP8 (*6)	500	4.0
MSOP8/VSSOP8 (*7)	470	3.76

Power Dissipation

Package	Pd[W]	θ_{ja} [°C/W]
SOIC14	610	4.9
TSSOP14	870	7.0

$$\theta_{ja} = (T_j - T_a) / P_d \text{ [}^\circ\text{C/W]}$$

Fig.102 Derating Curves

● Precautions

1) Unused circuits

When there are unused circuits, it is recommended that they be connected as in Figure 103, setting the non-inverting input terminal to a potential within the in-phase input voltage range (VICR).

2) Input terminal voltage

Applying GND + 32V to the input terminal is possible without causing deterioration of the electrical characteristics or destruction, irrespective of the supply voltage. However, this does not ensure normal circuit operation. Please note that the circuit operates normally only when the input voltage is within the common mode input voltage range of the electric characteristics.

3) Power supply (single / dual)

The op-amp operates when the voltage is applied between Vcc and GND. Therefore, the single supply op-amp can be used as a dual supply op-amp as well.

4) Power dissipation (Pd)

Using the unit in excess of the rated power dissipation may cause deterioration in electrical characteristics due to the rise of chip temperature, including reduced current capability. Therefore, please take into consideration the power dissipation (Pd) under the actual operating conditions and apply a sufficient margin in thermal design. Refer to the thermal derating curves for more information.

5) Short-circuits between pins and erroneous mounting

Incorrect mounting may damage the IC. In addition, the presence of foreign substances between the outputs, the output and the power supply, or the output and GND may also result in IC destruction.

6) Operation in a strong electromagnetic field

Operation in a strong electromagnetic field may cause malfunctions.

7) Radiation

This IC is not designed to withstand radiation.

8) IC handling

Applying mechanical stress to the IC by deflecting or bending the board may cause fluctuation of the electrical characteristics due to piezoelectric (piezo) effects.

9) IC operation

The output stage of the IC is configured using Class C push-pull circuits. Therefore, when the load resistor is connected to the middle potential of Vcc and GND, crossover distortion occurs at the changeover between discharging and charging of the output current. Connecting a resistor between the output terminal and GND and increasing the bias current for Class A operation will suppress crossover distortion.

10) Board inspection

Connecting a capacitor to a pin with low impedance may stress the IC. Therefore, discharging the capacitor after every process is recommended. In addition, when attaching and detaching the jig during the inspection phase, ensure that the power is turned OFF before inspection and removal. Furthermore, please take measures against ESD in the assembly process as well as during transportation and storage.

11) Output capacitor

Discharge of the external output capacitor to Vcc is possible via internal parasitic elements when Vcc is shorted to GND, causing damage to the internal circuitry due to thermal stress. Therefore, when using this IC in circuits where oscillation due to output capacitive load does not occur, such as in voltage comparators, use an output capacitor with a capacitance less than 0.1μF.

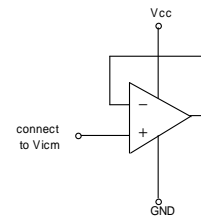

Fig.103 Disable circuit example

●Ordering part number

L M 2 9 0 2

Family name

LM358
 LM324
 LM2902
 LM2904

K

ESD tolerance application

K : 2kV
 None : Normal

V Q

Operating Voltage

VQ : 32V
 None : 26V

D

Package type

D : SOIC
 P W : TSSOP
 DGK : MSOP/VSSOP

R

R : Real

SOIC8

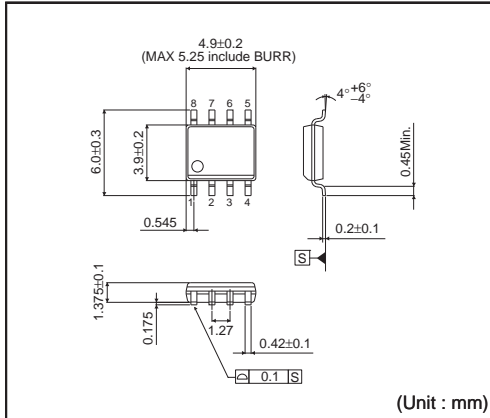

<Tape and Reel information>

Tape	Embossed carrier tape
Quantity	2500pcs
Direction of feed	(The direction is the 1pin of product is at the upper left when you hold reel on the left hand and you pull out the tape on the right hand)

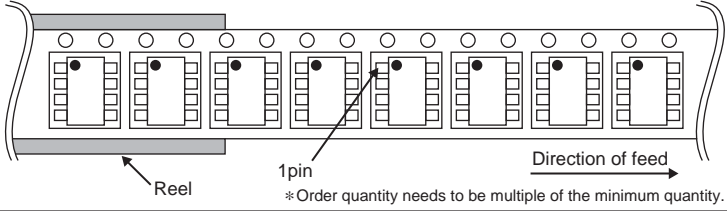

SOIC14

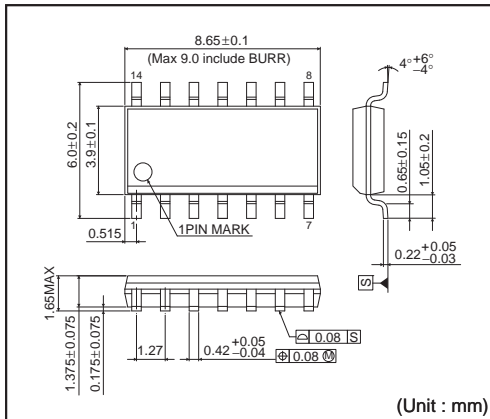

<Tape and Reel information>

Tape	Embossed carrier tape
Quantity	2500pcs
Direction of feed	(The direction is the 1pin of product is at the upper left when you hold reel on the left hand and you pull out the tape on the right hand)

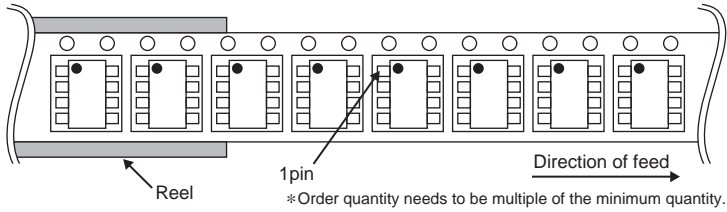

TSSOP8

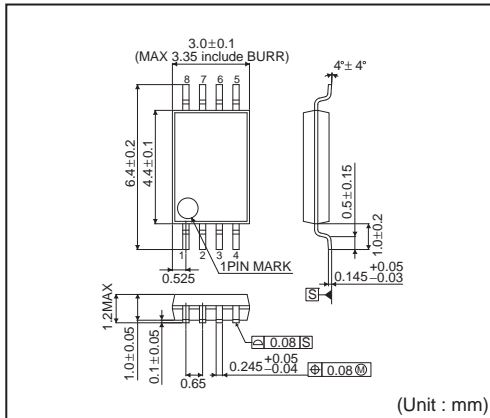

<Tape and Reel information>

Tape	Embossed carrier tape
Quantity	2500pcs
Direction of feed	(The direction is the 1pin of product is at the upper left when you hold reel on the left hand and you pull out the tape on the right hand)

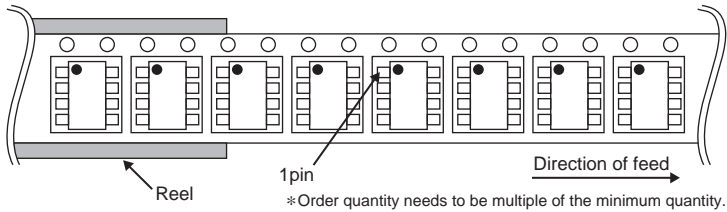

TSSOP14

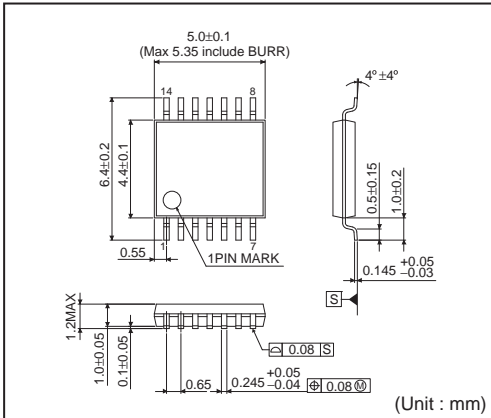

<Tape and Reel information>

Tape	Embossed carrier tape
Quantity	2500pcs
Direction of feed	(The direction is the 1pin of product is at the upper left when you hold reel on the left hand and you pull out the tape on the right hand)

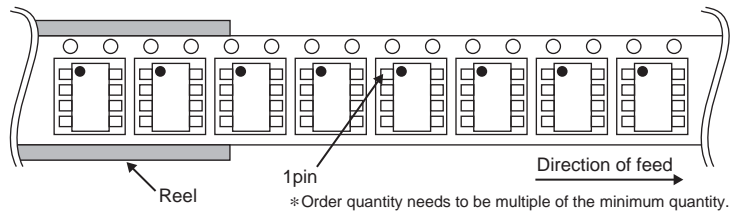

MSOP / VSSOP8

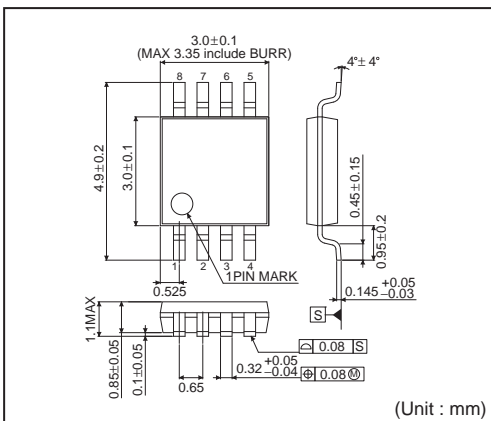

<Tape and Reel information>

Tape	Embossed carrier tape
Quantity	2500pcs
Direction of feed	(The direction is the 1pin of product is at the upper left when you hold reel on the left hand and you pull out the tape on the right hand)

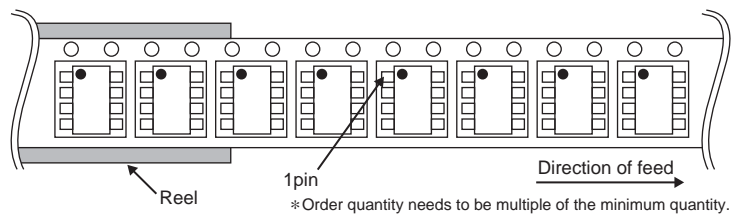

Notice

Precaution on using ROHM Products

- Our Products are designed and manufactured for application in ordinary electronic equipments (such as AV equipment, OA equipment, telecommunication equipment, home electronic appliances, amusement equipment, etc.). If you intend to use our Products in devices requiring extremely high reliability (such as medical equipment ^(Note 1), transport equipment, traffic equipment, aircraft/spacecraft, nuclear power controllers, fuel controllers, car equipment including car accessories, safety devices, etc.) and whose malfunction or failure may cause loss of human life, bodily injury or serious damage to property ("Specific Applications"), please consult with the ROHM sales representative in advance. Unless otherwise agreed in writing by ROHM in advance, ROHM shall not be in any way responsible or liable for any damages, expenses or losses incurred by you or third parties arising from the use of any ROHM's Products for Specific Applications.

(Note1) Medical Equipment Classification of the Specific Applications

JAPAN	USA	EU	CHINA
CLASS III	CLASS III	CLASS II b	CLASS III
CLASS IV		CLASS III	

- ROHM designs and manufactures its Products subject to strict quality control system. However, semiconductor products can fail or malfunction at a certain rate. Please be sure to implement, at your own responsibilities, adequate safety measures including but not limited to fail-safe design against the physical injury, damage to any property, which a failure or malfunction of our Products may cause. The following are examples of safety measures:
 - Installation of protection circuits or other protective devices to improve system safety
 - Installation of redundant circuits to reduce the impact of single or multiple circuit failure
- Our Products are designed and manufactured for use under standard conditions and not under any special or extraordinary environments or conditions, as exemplified below. Accordingly, ROHM shall not be in any way responsible or liable for any damages, expenses or losses arising from the use of any ROHM's Products under any special or extraordinary environments or conditions. If you intend to use our Products under any special or extraordinary environments or conditions (as exemplified below), your independent verification and confirmation of product performance, reliability, etc. prior to use, must be necessary:
 - Use of our Products in any types of liquid, including water, oils, chemicals, and organic solvents
 - Use of our Products outdoors or in places where the Products are exposed to direct sunlight or dust
 - Use of our Products in places where the Products are exposed to sea wind or corrosive gases, including Cl₂, H₂S, NH₃, SO₂, and NO₂
 - Use of our Products in places where the Products are exposed to static electricity or electromagnetic waves
 - Use of our Products in proximity to heat-producing components, plastic cords, or other flammable items
 - Sealing or coating our Products with resin or other coating materials
 - Use of our Products without cleaning residue of flux (even if you use no-clean type fluxes, cleaning residue of flux is recommended); or Washing our Products by using water or water-soluble cleaning agents for cleaning residue after soldering
 - Use of the Products in places subject to dew condensation
- The Products are not subject to radiation-proof design.
- Please verify and confirm characteristics of the final or mounted products in using the Products.
- In particular, if a transient load (a large amount of load applied in a short period of time, such as pulse. is applied, confirmation of performance characteristics after on-board mounting is strongly recommended. Avoid applying power exceeding normal rated power; exceeding the power rating under steady-state loading condition may negatively affect product performance and reliability.
- De-rate Power Dissipation (Pd) depending on Ambient temperature (Ta). When used in sealed area, confirm the actual ambient temperature.
- Confirm that operation temperature is within the specified range described in the product specification.
- ROHM shall not be in any way responsible or liable for failure induced under deviant condition from what is defined in this document.

Precaution for Mounting / Circuit board design

- When a highly active halogenous (chlorine, bromine, etc.) flux is used, the residue of flux may negatively affect product performance and reliability.
- In principle, the reflow soldering method must be used; if flow soldering method is preferred, please consult with the ROHM representative in advance.

For details, please refer to ROHM Mounting specification

Precautions Regarding Application Examples and External Circuits

1. If change is made to the constant of an external circuit, please allow a sufficient margin considering variations of the characteristics of the Products and external components, including transient characteristics, as well as static characteristics.
2. You agree that application notes, reference designs, and associated data and information contained in this document are presented only as guidance for Products use. Therefore, in case you use such information, you are solely responsible for it and you must exercise your own independent verification and judgment in the use of such information contained in this document. ROHM shall not be in any way responsible or liable for any damages, expenses or losses incurred by you or third parties arising from the use of such information.

Precaution for Electrostatic

This Product is electrostatic sensitive product, which may be damaged due to electrostatic discharge. Please take proper caution in your manufacturing process and storage so that voltage exceeding the Products maximum rating will not be applied to Products. Please take special care under dry condition (e.g. Grounding of human body / equipment / solder iron, isolation from charged objects, setting of ionizer, friction prevention and temperature / humidity control).

Precaution for Storage / Transportation

1. Product performance and soldered connections may deteriorate if the Products are stored in the places where:
 - [a] the Products are exposed to sea winds or corrosive gases, including Cl₂, H₂S, NH₃, SO₂, and NO₂
 - [b] the temperature or humidity exceeds those recommended by ROHM
 - [c] the Products are exposed to direct sunshine or condensation
 - [d] the Products are exposed to high Electrostatic
2. Even under ROHM recommended storage condition, solderability of products out of recommended storage time period may be degraded. It is strongly recommended to confirm solderability before using Products of which storage time is exceeding the recommended storage time period.
3. Store / transport cartons in the correct direction, which is indicated on a carton with a symbol. Otherwise bent leads may occur due to excessive stress applied when dropping of a carton.
4. Use Products within the specified time after opening a humidity barrier bag. Baking is required before using Products of which storage time is exceeding the recommended storage time period.

Precaution for Product Label

QR code printed on ROHM Products label is for ROHM's internal use only.

Precaution for Disposition

When disposing Products please dispose them properly using an authorized industry waste company.

Precaution for Foreign Exchange and Foreign Trade act

Since our Products might fall under controlled goods prescribed by the applicable foreign exchange and foreign trade act, please consult with ROHM representative in case of export.

Precaution Regarding Intellectual Property Rights

1. All information and data including but not limited to application example contained in this document is for reference only. ROHM does not warrant that foregoing information or data will not infringe any intellectual property rights or any other rights of any third party regarding such information or data. ROHM shall not be in any way responsible or liable for infringement of any intellectual property rights or other damages arising from use of such information or data.:
2. No license, expressly or implied, is granted hereby under any intellectual property rights or other rights of ROHM or any third parties with respect to the information contained in this document.

Other Precaution

1. This document may not be reprinted or reproduced, in whole or in part, without prior written consent of ROHM.
2. The Products may not be disassembled, converted, modified, reproduced or otherwise changed without prior written consent of ROHM.
3. In no event shall you use in any way whatsoever the Products and the related technical information contained in the Products or this document for any military purposes, including but not limited to, the development of mass-destruction weapons.
4. The proper names of companies or products described in this document are trademarks or registered trademarks of ROHM, its affiliated companies or third parties.

General Precaution

1. Before you use our Products, you are requested to carefully read this document and fully understand its contents. ROHM shall not be in any way responsible or liable for failure, malfunction or accident arising from the use of any ROHM's Products against warning, caution or note contained in this document.
2. All information contained in this document is current as of the issuing date and subject to change without any prior notice. Before purchasing or using ROHM's Products, please confirm the latest information with a ROHM sales representative.
3. The information contained in this document is provided on an "as is" basis and ROHM does not warrant that all information contained in this document is accurate and/or error-free. ROHM shall not be in any way responsible or liable for any damages, expenses or losses incurred by you or third parties resulting from inaccuracy or errors of or concerning such information.