



Micro Commercial Components

Micro Commercial Components
 20736 Marilla Street Chatsworth
 CA 91311
 Phone: (818) 701-4933
 Fax: (818) 701-4939

DTC123JKA

Features

- Epitaxial Planar Die Construction
- Complementary NPN Types Available
- Built-In Biasing Resistors
- Case Material: Molded Plastic. UL Flammability Classification Rating 94V-0
- Marking: E42

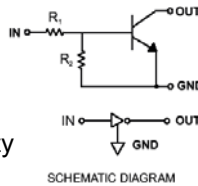

Digital Transistors

Absolute maximum ratings @ 25°C

Symbol	Parameter	Min	Typ	Max	Unit
V_{CC}	Supply voltage	---	50	---	V
V_{IN}	Input voltage	-5	---	+12	V
P_d	Power dissipation	---	200	---	mW
T_j	Junction temperature	---	150	---	°C
T_{stg}	Storage temperature	-55	---	150	°C
I_O	Output current	---	100	---	mA
$I_{C(MAX)}$		---	100	---	

Electrical Characteristics @ 25°C

Symbol	Parameter	Min	Typ	Max	Unit
$V_{I(off)}$	Input voltage ($V_{CC}=5V, I_O=100 \mu A$)	---	---	0.5	V
$V_{I(on)}$	Input voltage ($V_O=0.3V, I_O=5mA$)	1.1	---	---	V
$V_{O(on)}$	Output voltage ($I_O=5mA, I_I=0.25mA$)	---	0.1	0.3	V
I_I	Input current ($V_I=5V$)	---	---	3.6	mA
$I_{O(off)}$	Output current ($V_{CC}=50V, V_I=0$)	---	---	0.5	μA
G_I	DC current gain ($V_O=5V, I_O=10mA$)	80	---	---	
R_1	Input resistance	1.54	2.2	2.86	$K \Omega$
R_2/R_1	Resistance ratio	17	21	26	
f_T	Transition frequency ($V_{CE}=10V, I_E=5mA, f=100MHz$)	---	250	---	MHz

SOT-23-3L

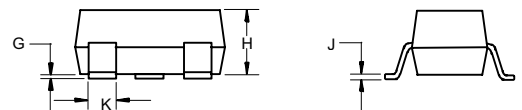
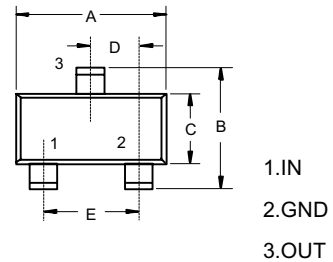

DIM	DIMENSIONS				NOTE
	INCHES		MM		
	MIN	MAX	MIN	MAX	
A	.113	.117	2.87	2.97	
B	.108	.112	2.75	2.85	
C	.061	.065	1.55	1.65	
D	.036	.038	.925	.975	
E	.073	.077	1.85	1.95	
G	.0016	.0039	.04	.100	
H	.044	.049	1.12	1.25	
J	.006	.007	.14	.17	
K	.013	.015	.34	.37	

Suggested Solder Pad Layout

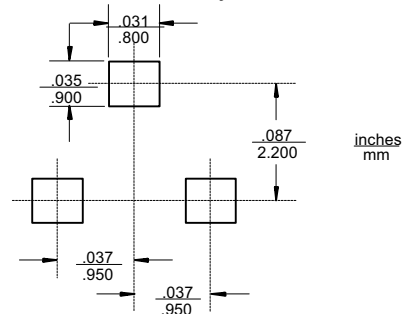

DTC123JKA



Micro Commercial Components

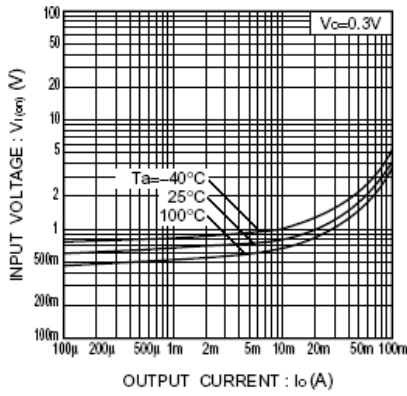

Fig.1 Input voltage vs. output current (ON characteristics)

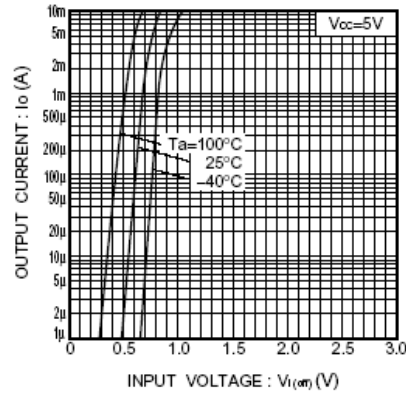

Fig.2 Output current vs. input voltage (OFF characteristics)

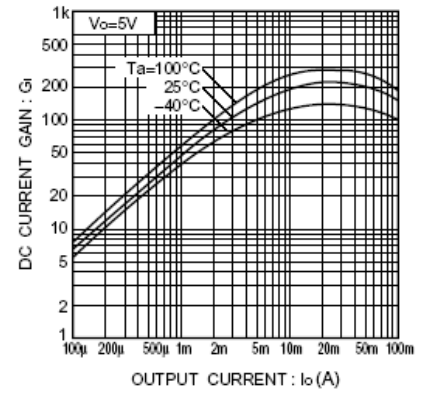

Fig.3 DC current gain vs. output current

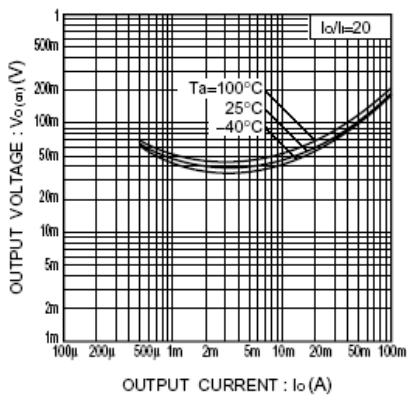

Fig.4 Output voltage vs. output current



TM

Micro Commercial Components

*****IMPORTANT NOTICE*****

Micro Commercial Components Corp. reserves the right to make changes without further notice to any product herein to make corrections, modifications, enhancements, improvements, or other changes. *Micro Commercial Components Corp.* does not assume any liability arising out of the application or use of any product described herein; neither does it convey any license under its patent rights, nor the rights of others. The user of products in such applications shall assume all risks of such use and will agree to hold *Micro Commercial Components Corp.* and all the companies whose products are represented on our website, harmless against all damages.

*****APPLICATIONS DISCLAIMER*****

Products offer by *Micro Commercial Components Corp.* are not intended for use in Medical, Aerospace or Military Applications.