



# RF Power LDMOS Transistor

## High Ruggedness N-Channel Enhancement-Mode Lateral MOSFET

Designed for handheld two-way radio applications with frequencies from 136 to 941 MHz. The high gain, ruggedness and wideband performance of this device make it ideal for large-signal, common-source amplifier applications in handheld radio equipment.

**Wideband Performance** (In 440–520 MHz reference circuit, 7.5 Vdc,  $T_A = 25^\circ\text{C}$ , CW)

Frequency (MHz)	$P_{in}$ (W)	$G_{ps}$ (dB)	$\eta_D$ (%)	$P_{out}$ (W)
440–520 (1,2)	0.16	16.2	62.0	6.5

**Narrowband Performance** (7.5 Vdc,  $T_A = 25^\circ\text{C}$ , CW)

Frequency (MHz)	$G_{ps}$ (B)	$\eta_D$ (%)	$P_{out}$ (W)
520 (3)	20.3	70.8	6.8

### Load Mismatch/Ruggedness

Frequency (MHz)	Signal Type	VSWR	$P_{in}$ (dBm)	Test Voltage	Result
520 (3)	CW	> 65:1 at all Phase Angles	21 (3 dB Overdrive)	10.8	No Device Degradation

1. Measured in 440–520 MHz broadband reference circuit (page 6).
2. The values shown are the minimum measured performance numbers across the indicated frequency range.
3. Measured in 520 MHz narrowband production test fixture (page 9).

### Features

- Characterized for operation from 136 to 941 MHz
- Unmatched input and output allowing wide frequency range utilization
- Integrated ESD protection
- Integrated stability enhancements
- Wideband — full power across the band
- Exceptional thermal performance
- Extreme ruggedness
- High linearity for: TETRA, SSB

### Typical Applications

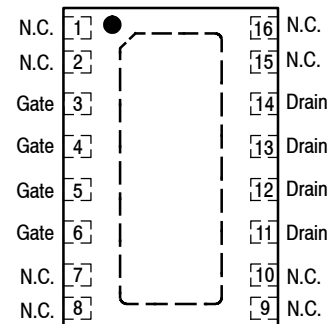
- Output stage VHF band handheld radio
- Output stage UHF band handheld radio
- Output stage for 700–800 MHz handheld radio
- Generic 6 W driver for ISM and broadcast final stage transistors

## AFM906N

136–941 MHz, 6.0 W, 7.5 V  
**WIDEBAND  
 AIRFAST RF POWER LDMOS  
 TRANSISTOR**



DFN 4 × 6



(Top View)

Note: Exposed backside of the package is the source terminal for the transistor.

**Figure 1. Pin Connections**

**Table 1. Maximum Ratings**

Rating	Symbol	Value	Unit
Drain-Source Voltage	$V_{DSS}$	-0.5, +30	Vdc
Gate-Source Voltage	$V_{GS}$	-6.0, +12	Vdc
Operating Voltage	$V_{DD}$	7.5, +0	Vdc
Storage Temperature Range	$T_{stg}$	-65 to +150	°C
Case Operating Temperature Range	$T_C$	-40 to +150	°C
Operating Junction Temperature Range (1,2)	$T_J$	-40 to +150	°C
Total Device Dissipation @ $T_C = 25^\circ\text{C}$ Derate above 25°C	$P_D$	65.8 0.53	W W/°C

**Table 2. Thermal Characteristics**

Characteristic	Symbol	Value (2,3)	Unit
Thermal Resistance, Junction to Case Case Temperature 78°C, 6 W CW, 7.5 Vdc, $I_{DQ} = 100$ mA, 520 MHz	$R_{\theta JC}$	1.9	°C/W

**Table 3. ESD Protection Characteristics**

Test Methodology	Class
Human Body Model (per JESD22-A114)	1C, passes 1000 V
Machine Model (per EIA/JESD22-A115)	A, passes 50 V
Charge Device Model (per JESD22-C101)	IV, passes 2000 V

**Table 4. Moisture Sensitivity Level**

Test Methodology	Rating	Package Peak Temperature	Unit
Per JESD22-A113, IPC/JEDEC J-STD-020	3	260	°C

**Table 5. Electrical Characteristics** ( $T_A = 25^\circ\text{C}$  unless otherwise noted)

Characteristic	Symbol	Min	Typ	Max	Unit
<b>Off Characteristics</b>					
Zero Gate Voltage Drain Leakage Current ( $V_{DS} = 30$ Vdc, $V_{GS} = 0$ Vdc)	$I_{DSS}$	—	—	2	$\mu\text{Adc}$
Zero Gate Voltage Drain Leakage Current ( $V_{DS} = 7.5$ Vdc, $V_{GS} = 0$ Vdc)	$I_{DSS}$	—	—	1	$\mu\text{Adc}$
Gate-Source Leakage Current ( $V_{GS} = 5$ Vdc, $V_{DS} = 0$ Vdc)	$I_{GSS}$	—	—	500	nAdc
<b>On Characteristics</b>					
Gate Threshold Voltage ( $V_{DS} = 10$ Vdc, $I_D = 78$ $\mu\text{Adc}$ )	$V_{GS(th)}$	1.8	2.15	2.6	Vdc
Drain-Source On-Voltage ( $V_{GS} = 10$ Vdc, $I_D = 0.78$ Adc)	$V_{DS(on)}$	—	0.11	—	Vdc
Forward Transconductance ( $V_{DS} = 7.5$ Vdc, $I_D = 4.7$ Adc)	$g_{fs}$	—	4.4	—	S

1. Continuous use at maximum temperature will affect MTTF.
2. MTTF calculator available at <http://www.nxp.com/RF/calculators>.
3. Refer to AN1955, *Thermal Measurement Methodology of RF Power Amplifiers*. Go to <http://www.nxp.com/RF> and search for AN1955.

(continued)

**Table 5. Electrical Characteristics** ( $T_A = 25^\circ\text{C}$  unless otherwise noted) (continued)

Characteristic	Symbol	Min	Typ	Max	Unit
<b>Dynamic Characteristics</b>					
Reverse Transfer Capacitance ( $V_{DS} = 7.5\text{ Vdc} \pm 30\text{ mV(rms)ac}$ @ 1 MHz, $V_{GS} = 0\text{ Vdc}$ )	$C_{rss}$	—	1.7	—	pF
Output Capacitance ( $V_{DS} = 7.5\text{ Vdc} \pm 30\text{ mV(rms)ac}$ @ 1 MHz, $V_{GS} = 0\text{ Vdc}$ )	$C_{oss}$	—	39.8	—	pF
Input Capacitance ( $V_{DS} = 7.5\text{ Vdc}$ , $V_{GS} = 0\text{ Vdc} \pm 30\text{ mV(rms)ac}$ @ 1 MHz)	$C_{iss}$	—	68.9	—	pF

**Functional Tests** (In NXP Narrowband Production Test Fixture, 50 ohm system)  $V_{DD} = 7.5\text{ Vdc}$ ,  $I_{DQ} = 100\text{ mA}$ ,  $P_{in} = 18\text{ dBm}$ ,  $f = 520\text{ MHz}$

Common-Source Amplifier Output Power	$P_{out}$	—	6.8	—	W
Drain Efficiency	$\eta_D$	—	70.8	—	%

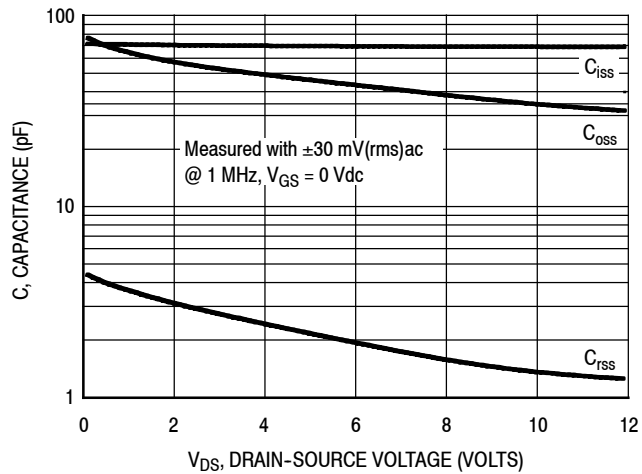
**Load Mismatch/Ruggedness** (In NXP Test Narrowband Production Fixture, 50 ohm system)  $I_{DQ} = 100\text{ mA}$

Frequency (MHz)	Signal Type	VSWR	$P_{in}$ (dBm)	Test Voltage, $V_{DD}$	Result
520	CW	> 65:1 at all Phase Angles	21 (3 dB Overdrive)	10.8	No Device Degradation

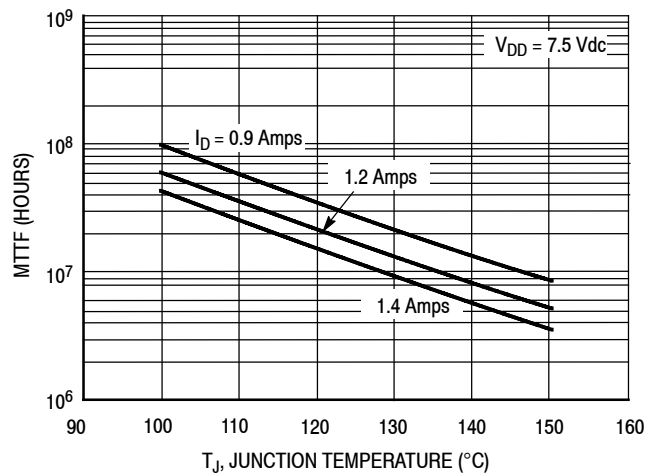
**Table 6. Ordering Information**

Device	Tape and Reel Information	Package
AFM906NT1	T1 Suffix = 1,000 Units, 16 mm Tape Width, 7-inch Reel	DFN 4 × 6

## TYPICAL CHARACTERISTICS



**Figure 2. Capacitance versus Drain-Source Voltage**



**Note:** MTTF value represents the total cumulative operating time under indicated test conditions.

MTTF calculator available at <http://www.nxp.com/RF/calculators>.

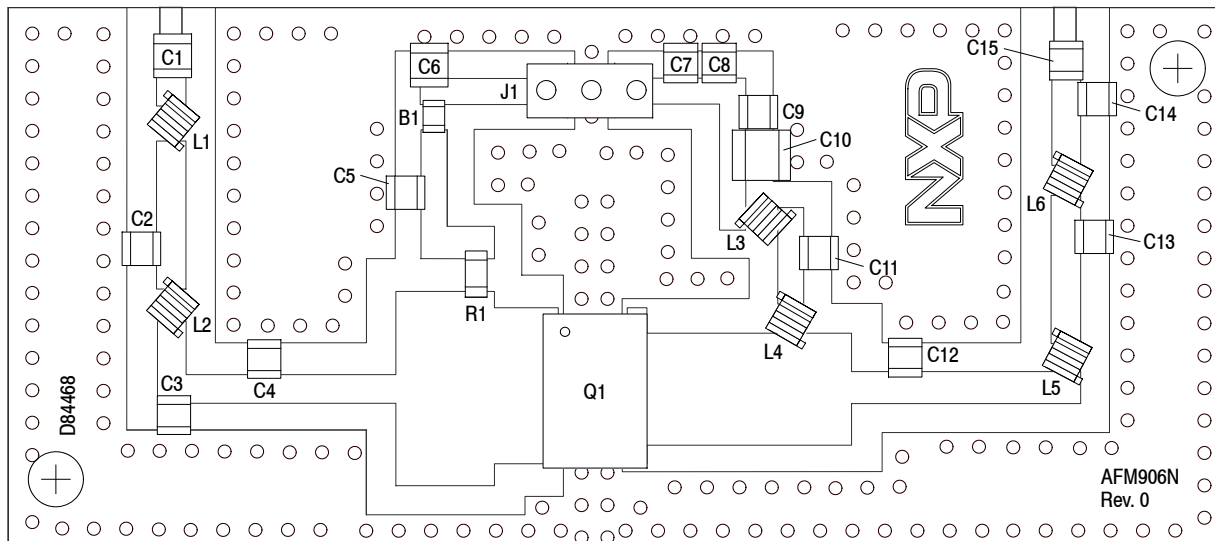
**Figure 3. MTTF versus Junction Temperature – CW**

## 440–520 MHz UHF BROADBAND REFERENCE CIRCUIT

**Table 7. 440–520 MHz UHF Broadband Performance** (In NXP UHF Broadband Reference Circuit, 50 ohm system)  $V_{DD} = 7.5$  Vdc,  $I_{DQ} = 150$  mA,  $T_A = 25^\circ\text{C}$ , CW

Frequency (MHz)	$P_{in}$ (W)	$G_{ps}$ (dB)	$\eta_D$ (%)	$P_{out}$ (W)
440	0.1	18.1	61.2	6.5
480	0.1	18.1	66.0	6.5
520	0.11	17.8	66.5	6.5

**440-520 MHz UHF BROADBAND REFERENCE CIRCUIT —  
0.83" × 1.88" (21.1 mm × 47.8 mm)**

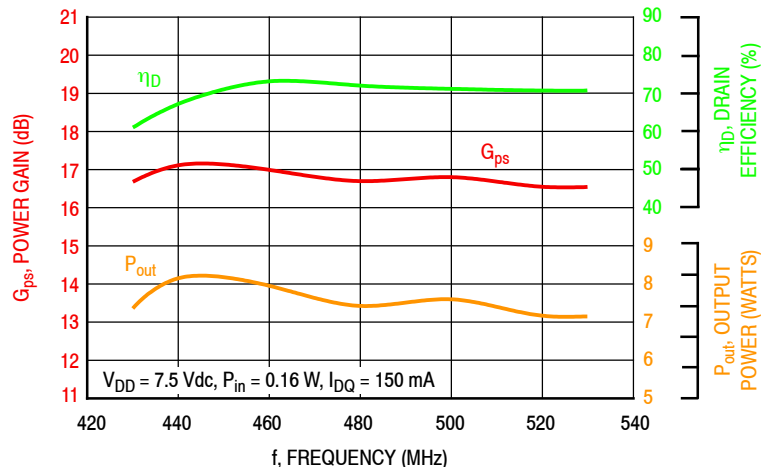


**Figure 4. AFM906N UHF Broadband Reference Circuit Component Layout — 440-520 MHz**

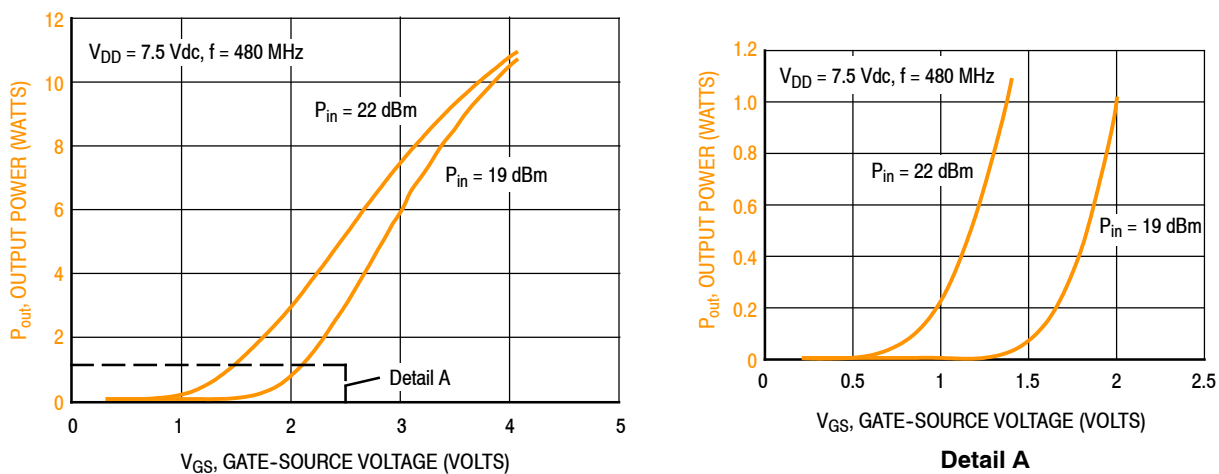
**Table 8. AFM906N UHF Broadband Reference Circuit Component Designations and Values — 440-520 MHz**

Part	Description	Part Number	Manufacturer
B1	30 Ω, 6 A Ferrite Bead	MPZ2012S300AT000	TDK
C1, C5, C15	100 pF Chip Capacitors	ATC600F101JT250XT	ATC
C2, C11	15 pF Chip Capacitors	ATC600F150JT250XT	ATC
C3	39 pF Chip Capacitor	ATC600F390JT250XT	ATC
C4, C12	47 pF Chip Capacitors	ATC600F470JT250XT	ATC
C6, C7	0.1 μF Chip Capacitors	GRM21BR71H104KA01B	Murata
C8	0.01 μF Chip Capacitor	GRM21BR72A103KA01B	Murata
C9	200 pF Chip Capacitor	GQM2195C2A201GB12D	Murata
C10	2.2 μF Chip Capacitor	GRM31CR71H225KA88L	Murata
C13	22 pF Chip Capacitor	ATC600F220JT250XT	ATC
C14	5.1 pF Chip Capacitor	ATC600F5R1BT250XT	ATC
J1	Right-Angle Breakaway Headers (3 Pins)	22-28-8360	Molex
L1, L2	5.5 nH Inductors	0806SQ-5N5JLC	Coilcraft
L3, L6	8.1 nH Inductors	0908SQ-8N1JLC	Coilcraft
L4	6 nH Inductor	0806SQ-6N0JLC	Coilcraft
L5	1.65 nH Inductor	0906-2JLC	Coilcraft
Q1	RF Power LDMOS Transistor	AFM906N	NXP
R1	10 Ω, 1/4 W Chip Resistor	CRCW120610R0JNEA	Vishay
PCB	0.020", ε <sub>r</sub> = 4.8, Shengyi S1000-2	D84468	MTL

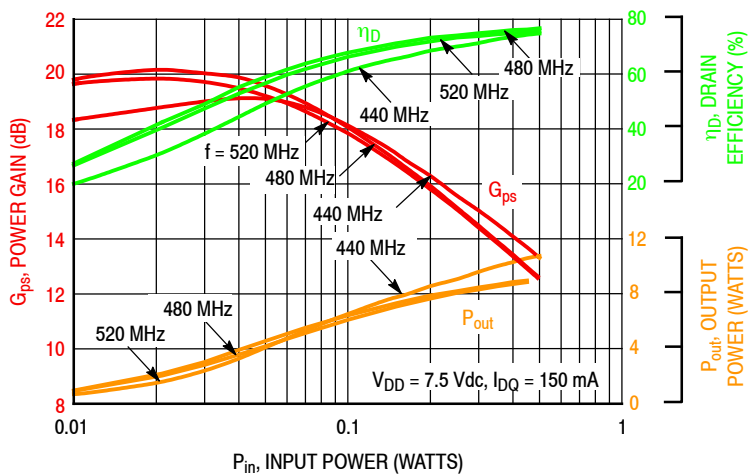
## TYPICAL CHARACTERISTICS — 440–520 MHz UHF BROADBAND REFERENCE CIRCUIT



**Figure 5. Power Gain, Drain Efficiency and Output Power versus Frequency at a Constant Input Power — 7.5 Vdc**

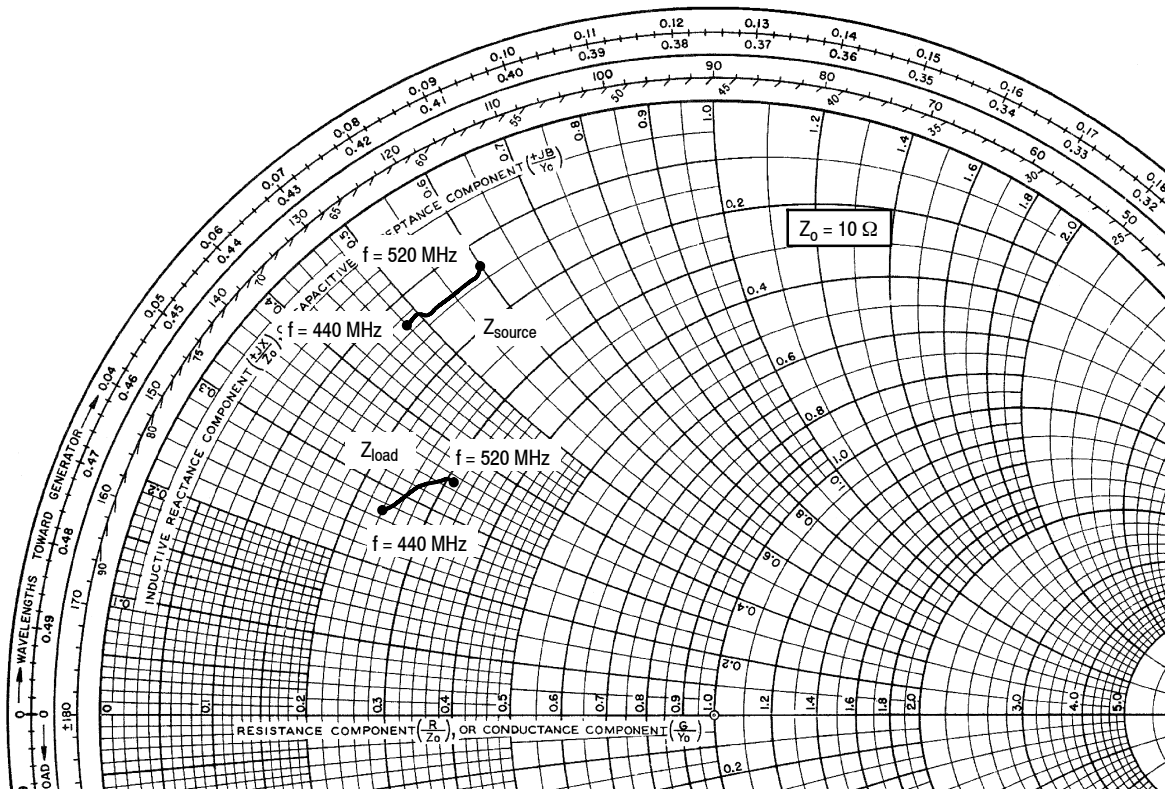


**Figure 6. Output Power versus Gate-Source Voltage**



**Figure 7. Power Gain, Drain Efficiency and Output Power versus Input Power and Frequency**

## 440–520 MHz UHF BROADBAND REFERENCE CIRCUIT



f MHz	$Z_{source}$ $\Omega$	$Z_{load}$ $\Omega$
440	$1.3 + j4.8$	$2.4 + j2.7$
450	$1.3 + j5.0$	$2.5 + j2.8$
460	$1.4 + j5.1$	$2.6 + j3.0$
470	$1.4 + j5.3$	$2.7 + j3.2$
480	$1.4 + j5.4$	$2.8 + j3.3$
490	$1.4 + j5.6$	$2.9 + j3.4$
500	$1.4 + j5.7$	$2.9 + j3.4$
510	$1.4 + j5.8$	$3.0 + j3.5$
520	$1.3 + j6.0$	$3.1 + j3.5$

$Z_{source}$  = Test circuit impedance as measured from gate to ground.

$Z_{load}$  = Test circuit impedance as measured from drain to ground.

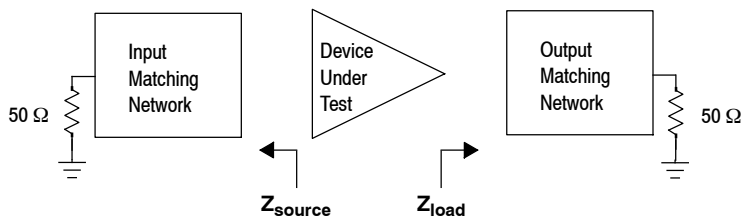
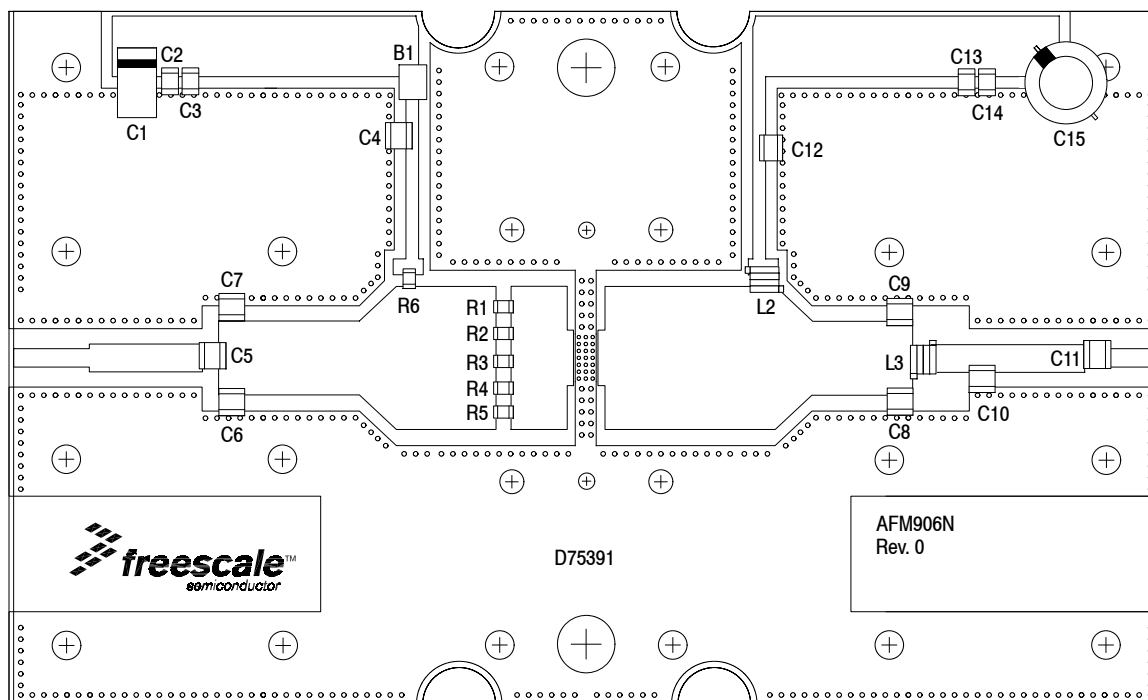


Figure 8. UHF Broadband Series Equivalent Source and Load Impedance — 440–520 MHz



## 520 MHz NARROWBAND PRODUCTION TEST FIXTURE — 3" × 5" (7.6 cm × 12.7 cm)

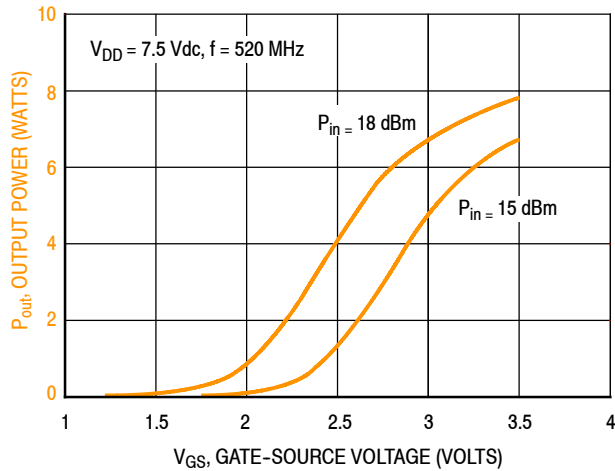


**Figure 9. AFM906N Narrowband Test Circuit Component Layout — 520 MHz**

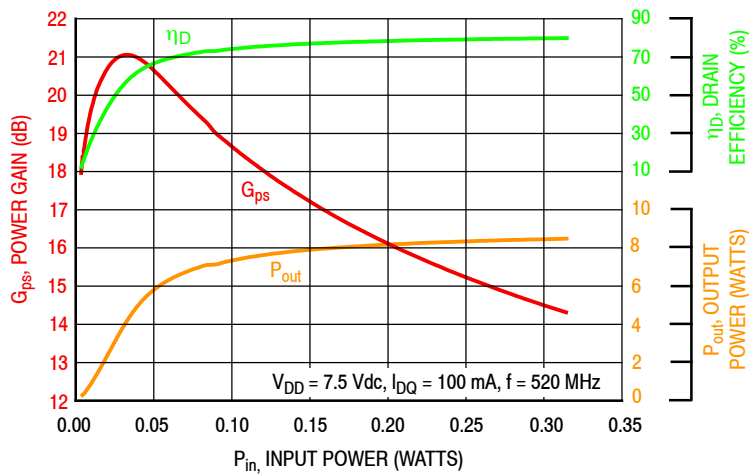
**Table 9. AFM906N Narrowband Test Circuit Component Designations and Values — 520 MHz**

Part	Description	Part Number	Manufacturer
B1	Short RF Bead	2743019447	Fair-Rite
C1	22 μF, 35 V Tantalum Capacitor	T491X226K035AT	Kemet
C2, C14	0.1 μF Chip Capacitors	CDR33BX104AKWS7370	Kemet
C3, C13	0.01 μF Chip Capacitors	C0805C103K5RACTU	Kemet
C4, C12	180 pF Chip Capacitors	ATC100B181JT300XT	ATC
C5	9.1 pF Chip Capacitor	ATC100B9R1CT500XT	ATC
C6, C11	15 pF Chip Capacitors	ATC100B150JT500XT	ATC
C7	13 pF Chip Capacitor	ATC100B130JT500XT	ATC
C8, C9	16 pF Chip Capacitors	ATC100B160JT500XT	ATC
C10	2 pF Chip Capacitor	ATC100B2R0BT500XT	ATC
C15	330 μF, 35 V Electrolytic Capacitor	MCGPR35V337M10X16-RH	Multicomp
L2	8 nH Inductor, 3 Turns	A03TKLC	Coilcraft
L3	5 nH Inductor, 2 Turns	A02TKLC	Coilcraft
R1, R2, R3, R4, R5	1.5 Ω, 1/4 W Chip Resistors	RC1206FR-071R5L	Yageo
R6	27 Ω, 1/4 W Chip Resistor	CRCW120627R0FKEA	Vishay
PCB	Rogers RO4350B, 0.030", $\epsilon_r = 3.66$	D75391	MTL

**TYPICAL CHARACTERISTICS — 520 MHz NARROWBAND  
PRODUCTION TEST FIXTURE**



**Figure 10. Output Power versus Gate-Source Voltage**



**Figure 11. Power Gain, Drain Efficiency, and Output Power versus Input Power**

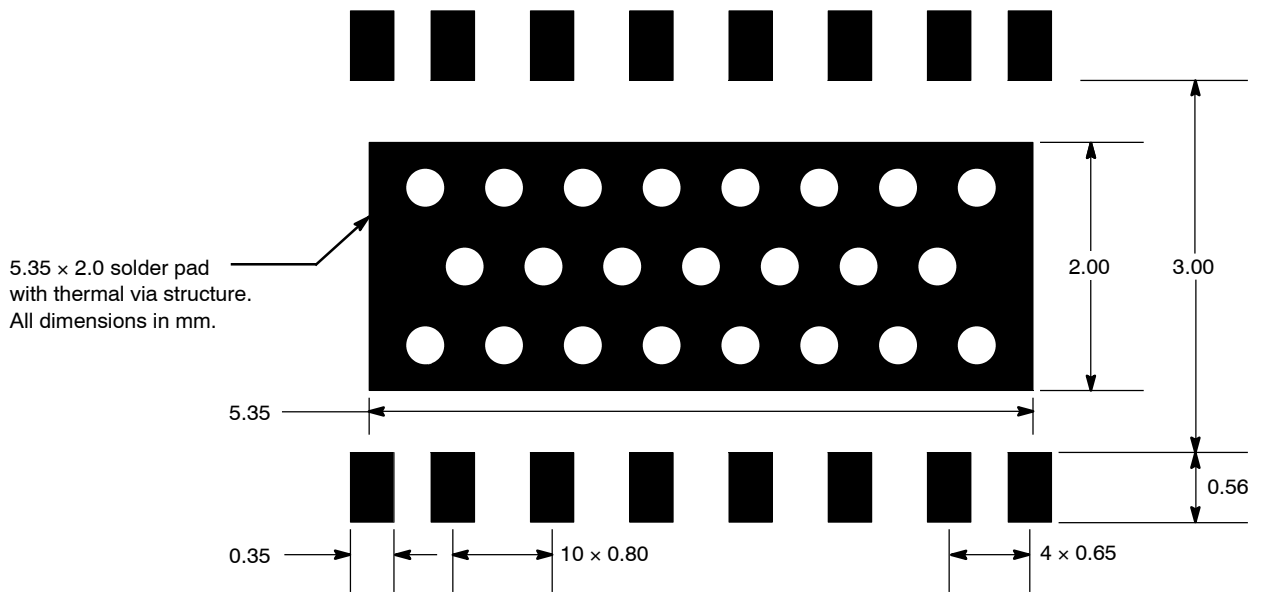
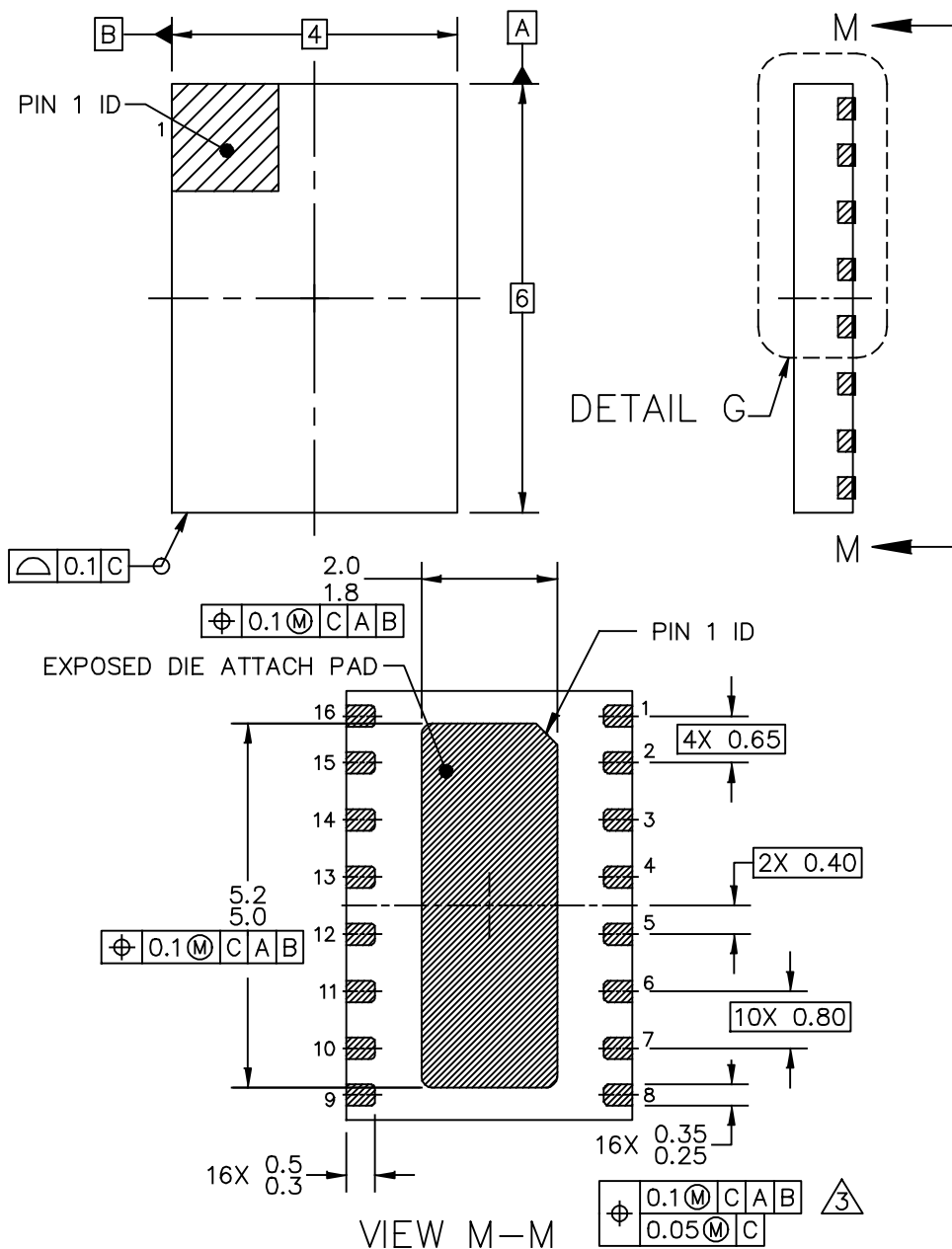


Figure 12. PCB Pad Layout for 16-Lead DFN 4 × 6

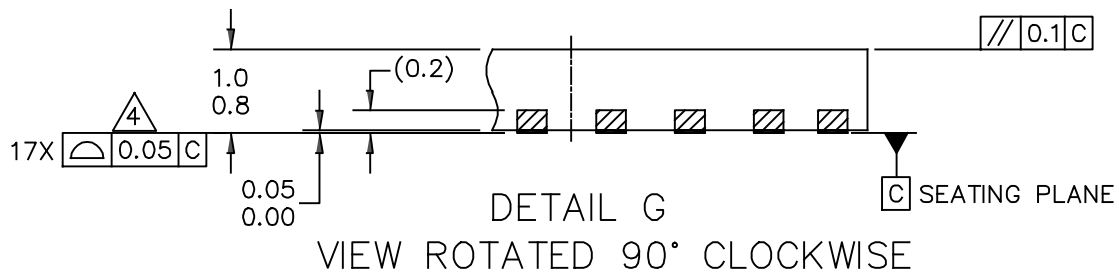


Figure 13. Product Marking

PACKAGE DIMENSIONS



© NXP SEMICONDUCTORS N.V. ALL RIGHTS RESERVED	MECHANICAL OUTLINE	PRINT VERSION NOT TO SCALE
TITLE: DFN, THERMALLY ENHANCED 4 X 6 X 0.9, 0.8 & 0.65 PITCH, 16 TERMINAL	DOCUMENT NO: 98ASA00868D	REV: B
	STANDARD: NON-JEDEC	
	SOT1862-1	27 JUL 2016



© NXP SEMICONDUCTORS N.V. ALL RIGHTS RESERVED	MECHANICAL OUTLINE	PRINT VERSION NOT TO SCALE
TITLE: DFN, THERMALLY ENHANCED 4 X 6 X 0.9, 0.8 & 0.65 PITCH, 16 TERMINAL	DOCUMENT NO: 98ASA00868D	REV: B
	STANDARD: NON-JEDEC	
	SOT1862-1	27 JUL 2016

NOTES:

1. DIMENSIONING & TOLERANCING CONFIRM TO ASME Y14.5M–1994.
2. ALL DIMENSIONS ARE IN MILLIMETERS. ANGLES ARE IN DEGREES.
3. THIS DIMENSION APPLIES TO METALLIZED TERMINAL AND IS MEASURED BETWEEN 0.25 MM AND 0.30 MM FROM TERMINAL TIP.
4. COPLANARITY APPLIES TO THE EXPOSED HEAT SLUG AS WELL AS THE TERMINALS.

© NXP SEMICONDUCTORS N.V. ALL RIGHTS RESERVED	MECHANICAL OUTLINE	PRINT VERSION NOT TO SCALE
TITLE: DFN, THERMALLY ENHANCED 4 X 6 X 0.9, 0.8 & 0.65 PITCH, 16 TERMINAL	DOCUMENT NO: 98ASA00868D	REV: B
	STANDARD: NON–JEDEC	
	SOT1862–1	27 JUL 2016

## PRODUCT DOCUMENTATION, SOFTWARE AND TOOLS

Refer to the following resources to aid your design process.

### Application Notes

- AN1907: Solder Reflow Attach Method for High Power RF Devices in Over-Molded Plastic Packages
- AN1955: Thermal Measurement Methodology of RF Power Amplifiers

### Engineering Bulletins

- EB212: Using Data Sheet Impedances for RF LDMOS Devices

### Software

- Electromigration MTTF Calculator
- RF High Power Model
- .s2p File

### Development Tools

- Printed Circuit Boards

### To Download Resources Specific to a Given Part Number:

1. Go to <http://www.nxp.com/RF>
2. Search by part number
3. Click part number link
4. Choose the desired resource from the drop down menu

## REVISION HISTORY

The following table summarizes revisions to this document.

Revision	Date	Description
0	July 2016	<ul style="list-style-type: none"><li>• Initial release of data sheet</li></ul>
1	Aug. 2016	<ul style="list-style-type: none"><li>• 440-520 MHz UHF broadband reference circuit: added performance data and graphs, reference circuit component layout and component designations, pp. 5-8.</li></ul>

## ***How to Reach Us:***

**Home Page:**  
nxp.com

**Web Support:**  
nxp.com/support

Information in this document is provided solely to enable system and software implementers to use NXP products. There are no express or implied copyright licenses granted hereunder to design or fabricate any integrated circuits based on the information in this document. NXP reserves the right to make changes without further notice to any products herein.

NXP makes no warranty, representation, or guarantee regarding the suitability of its products for any particular purpose, nor does NXP assume any liability arising out of the application or use of any product or circuit, and specifically disclaims any and all liability, including without limitation consequential or incidental damages. "Typical" parameters that may be provided in NXP data sheets and/or specifications can and do vary in different applications, and actual performance may vary over time. All operating parameters, including "typicals," must be validated for each customer application by customer's technical experts. NXP does not convey any license under its patent rights nor the rights of others. NXP sells products pursuant to standard terms and conditions of sale, which can be found at the following address: [nxp.com/SalesTermsandConditions](http://nxp.com/SalesTermsandConditions).

NXP, the NXP logo, Freescale, the Freescale logo, and Airfast are trademarks of NXP B.V. All other product or service names are the property of their respective owners.  
© 2016 NXP B.V.

