

# 2013 Product Selection Guide

**MACOM**<sup>TM</sup>

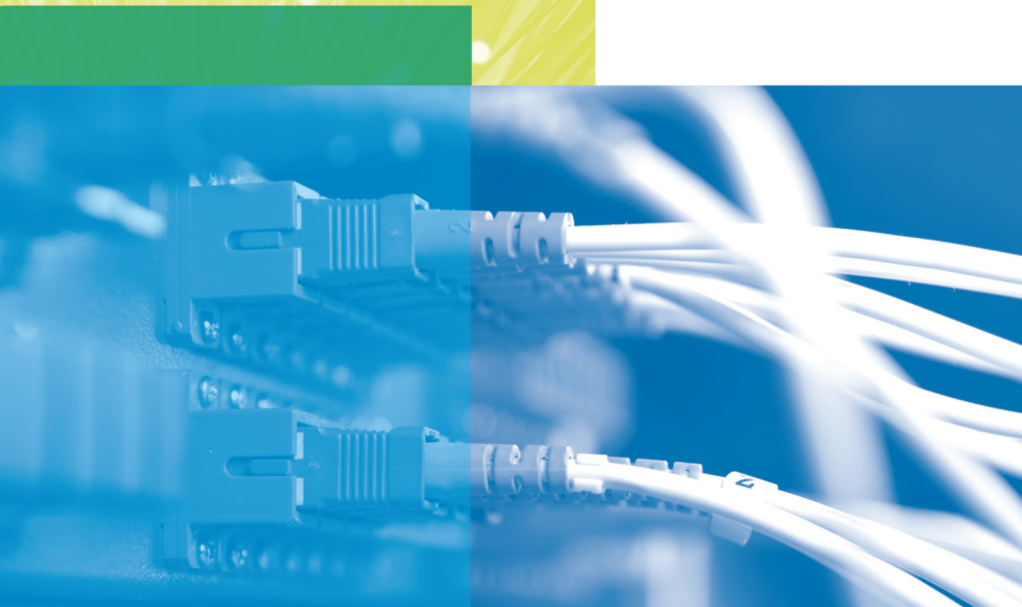

M/A-COM Technology Solutions Inc.'s (MACOM) **2013 Product Selection Guide** features our complete range of RF and microwave products. Inside, you will find detailed product specifications and block diagrams designed to help engineers quickly evaluate and select the right products to differentiate their designs.

We have more than sixty years of hands-on experience designing and building analog semiconductor technology across the RF, microwave and millimeter wave spectrum. Our team works with you, engineer-to-engineer, to identify solutions and inspire success in markets from Aerospace to Automotive, Infrastructure to Industrial, and Military to Medical.

Additional product information can be found on our website at [macomtech.com](http://www.macomtech.com). Contact our worldwide sales offices, authorized representatives, and industry-leading distributors to request samples, test boards, and application support. All contacts are listed on our website at: <http://www.macomtech.com/Content/contactus>

MACOM's broad portfolio of products, combined with our global organization of expert engineers, can help you solve the world's most demanding wireless and wireline application challenges.

## Markets 4-12

Point-to-Point and Infrastructure  
CATV and Broadband  
Optoelectronics  
Aerospace and Defense

## Amplifiers 10-18

Broadband Amplifiers  
CATV Amplifiers and Active Splitters  
CATV MoCA Front End ICs  
Driver Amplifiers  
Low Noise Amplifiers  
Power Amplifiers  
General Amplifiers

## Attenuators 19-21

Voltage Variable Attenuators  
Digital Attenuators  
CATV Digital Attenuators

## Diodes 22-28

Limiter Diodes  
Multiplier Diodes  
Mixing and Detector Diodes  
Switch and Attenuator Diodes  
Tuning Diodes

## Drivers 29

Drivers

## Frequency Doublers 30-31

Frequency Doublers

## Limiters 32-33

Limiting Amplifiers  
Packaged Limiters  
Signal Limiters

## Modulators and Mixers 34-39

Demodulators  
Receivers  
Up/Down Converters  
Mixers

## Optoelectronics 40-41

Modulator Driver Amplifiers  
Transimpedance Amplifiers  
Limiting Amplifiers

## Passives 42-55

Transformers  
Designer's Kit  
CATV Transformers  
Capacitors  
Inductors  
CATV Power Splitters/Combiners  
Couplers  
CATV Couplers  
Filters/Diplexers  
CATV Diplexer Filters  
CATV MoCA Filters

## Power Detectors 56

Power Detectors

## Switches 57-61

General  
CATV Switches  
Switches with Drivers  
Switch Limiters

## Transistors 62-70

Communication, Broadcast,  
Industrial, Scientific, Medical  
Avionics  
Broadcast Modules and Pallets  
Radar: L- and S-Band  
GaN RF Power

## Voltage Controlled Oscillators 71-74

Voltage Controlled Oscillators  
Signal Sources: Low Noise VCOs

## Appendix and Index 76-89

Package Selection Guide  
Decibels-Volts-Watts Conversion Table  
Wavelength and Frequency  
Telecommunications Standards  
Part Number Index

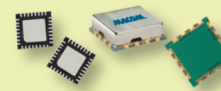
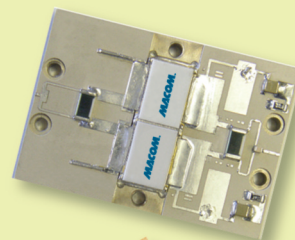
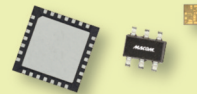
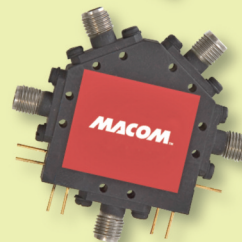
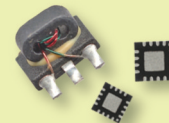
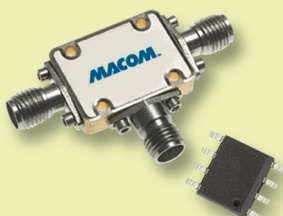
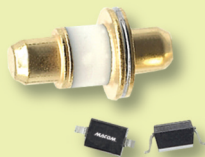
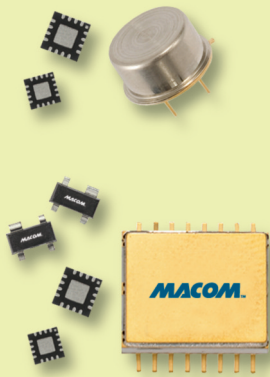



# About MACOM



## Partners in RF and Microwave

MACOM ([macomtech.com](http://macomtech.com)) is a leading supplier of high-performance semiconductors, active and passive components, and subassemblies for use in radio frequency (RF), microwave, and millimeter wave applications. Our broad portfolio of more than 3,000 products can help accelerate your growth in markets including CATV, wireless infrastructure, optical communications, aerospace and defense, automotive, industrial, medical, and mobile devices. We are proud of our more than sixty years of hands-on experience designing and building analog semiconductor technology across the RF, microwave, and millimeter wave spectrum.

Headquartered in Lowell, Massachusetts, MACOM is certified to the ISO 9001 international quality standard and the ISO 14001 environmental management standard. MACOM has design centers and sales offices throughout North America, Europe, Asia, and Australia.

## RF and Microwave Capabilities

MACOM offers end-to-end customer solutions and support, from proprietary process technologies to high-quality customer service. We can produce and process semiconductor materials, design and manufacture complex devices, and combine these devices into multi-function components. We offer dual-use technologies that enable us to service commercial and aerospace and defense markets. We have unique technologies and capabilities to create innovative design solutions, including:

- Si, GaAs, AlGaAs, InGaAs, InP, GaN, SiGe, and RF CMOS IC products
- Unique processes: HMIC™, GMIC™ and AlGaAs™
- In-house design, fabrication, assembly, and screening capabilities
- Multiple design and sales locations to provide global coverage
- Wide spectrum coverage from RF to millimeter wave frequencies
- One of the broadest selections of standard and custom products in the industry



### Commercial, Industrial and Military Products

This guide features our catalog products. We work with you, engineer-to-engineer, to provide custom products to meet your unique application-specific requirements. If you cannot find a product that meets your needs in this guide, please contact us and we will work together to develop or recommend an appropriate solution. Our dependable team of product managers and engineers is available to support all product and management needs, and offers the experience and attention to detail that ensure success.

### Quality and Reliability

MACOM is committed to delivering high-quality products and services that meet our customers' and internal operations' needs in terms of delivery, reliability, performance and value. Process controls are implemented to ensure that tasks are performed properly the first time, so that products and services meet established, agreed-to requirements. It is the personal responsibility of every MACOM employee to ensure quality, customer satisfaction, continual improvement, maintenance of our quality management system and compliance with customer and regulatory requirements.

### Design and Manufacturing Facilities

MACOM hosts design, Si and GaAs fabrication, and other operational facilities in a number of geographies. We operate ISO 9001 facilities in Lowell, Massachusetts; Long Beach and Santa Clara, California; Cork, Ireland; Belfast, Northern Ireland; and Sydney, Australia.

#### How to Purchase

##### Sales Representatives and Distribution Partners

Most of the standard products listed in this selection guide are available directly from your local MACOM sales office or nearest sales representative.

Visit our website at <http://www.macomtech.com/Content/contactus> for a list of our industry-leading distributors.

##### eCommerce

Our products are also available for purchase online. To purchase, simply browse our products and click the "buy" button to add products to your cart.

For inquiries about your e-Commerce order contact our customer service team:

Online: <https://www.macomtech.com/forms/customerservicerequest>

Phone: 1.978.656.2222

For general e-Commerce inquiries, contact: [ecommerce@macomtech.com](mailto:ecommerce@macomtech.com).

**MACOM produces custom products and modifications to standard products to meet your specific requirements. Please contact us with your specifications if you cannot find a standard product for your application. See the back cover of this catalog for contact information.**

**Or visit us at [macomtech.com](http://www.macomtech.com) for more information.**

# Point-to-Point and Infrastructure



## MACOM 42 GHz SmartSet Chipset

High reliability and cost-effective solution

- MACOM offers a complete solution for 42 GHz point-to-point radio applications
- Systems-driven approach to integration, coupled with innovative IC and package design capabilities, enable OEM customers to achieve faster time-to-market with optimal performance
- Offered in convenient surface mount packages, facilitating the use of common high-volume assembly lines in lower-cost manufacturing operations.

## Point-to-Point Backhaul Evolution

High performance for increasing capacity needs

MACOM understands that ever-increasing bandwidth demands, from mobile device usage, require more advanced backhaul systems to meet increasing capacity needs. We also realize that microwave point-to-point (PtP) systems provide an ideal choice for backhaul, particularly where optical fiber is cost prohibitive in areas such as dense urban environments. Our chipset offers a high performance solution for the 40.5-43.5 GHz band which will open up additional spectrum for voice, video, and data transmission over cellular backhaul systems.

## MACOM Infrastructure Products

Supporting 3G and 4G base station infrastructure applications

MACOM offers a wide variety of products to support the demanding requirements of today's 3G and 4G base station infrastructure applications. Our portfolio includes low noise amplifiers, driver amplifiers, gain blocks, high power switches, digital and analog attenuators, high isolation switches, transformers and discrete diodes.

Our products deliver leading edge solutions to today's challenging wireless communications systems. We supply both standard products and custom solutions that set the industry standard for high performance and reliability.

For more information, including advanced data sheets, please contact your MACOM sales office or visit [macomtech.com](http://macomtech.com)

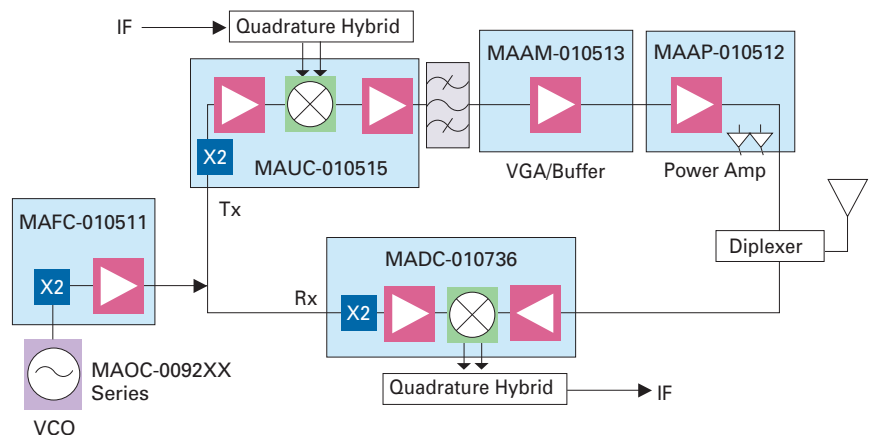
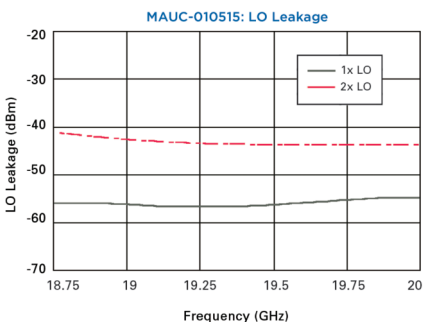
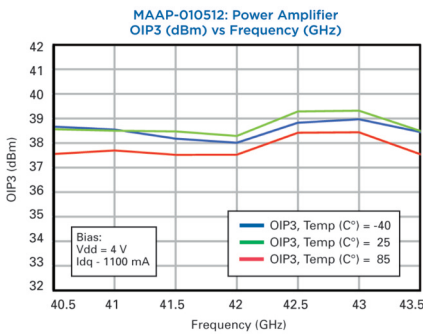

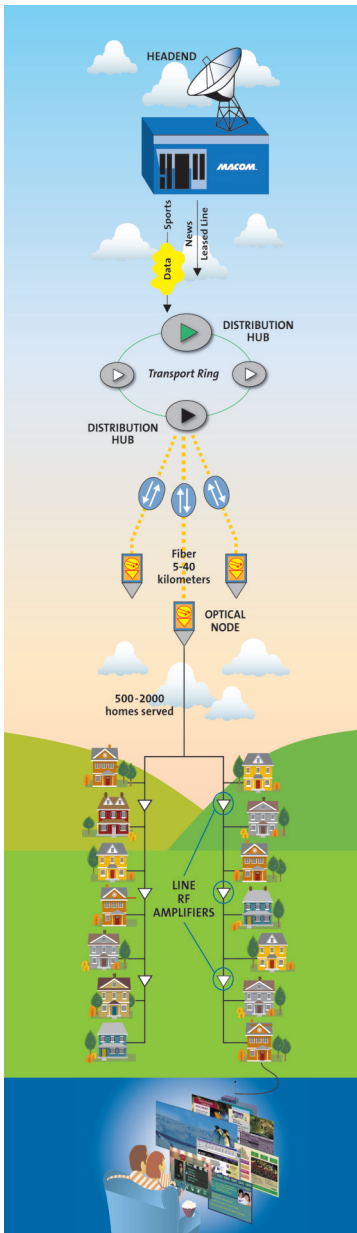

## Delivering comprehensive solutions for demanding CATV and broadband applications

MACOM offers an extensive range of components and modules for MoCA®, DOCSIS® and EdgeQAM as well as FTTx system nodes and interconnect applications. We make components for the “RF side” of the fiberoptic cable network.

- EdgeQAM-DOCSIS variable gain amplifiers
- FTTx RF amplifiers
- Low noise amplifiers and gain blocks
- Ultra-low noise, high linearity active splitters
- MoCA triplex, duplex and bandpass filters
- High isolation, low-loss multi-way switches
- Digital step attenuators
- Multi-function ICs
- Transformers, couplers and power dividers

From head end to client side, applications include:

- EdgeQAM distribution equipment
- Hybrid fiber coax (HFC) nodes
- Line extenders and drop amplifiers
- FTTx passive optical nodes
- Optical Network Terminals (ONT)
- Customer premises equipment and cable modems
- Interdiction and telephony systems
- MoCA, home gateway and Ethernet-to-Coax Bridges (ECB)



# CATV and Broadband

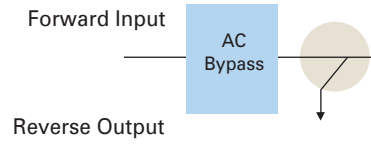

Baluns:  
 MABACT0051 (Forward)  
 MABACT0055 (Forward)  
 MABACT0036 (Reverse)  
 MABACT0045 (Reverse)

## Head End Modules – Modulator Output

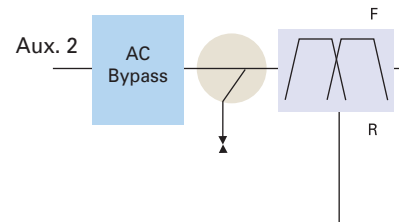
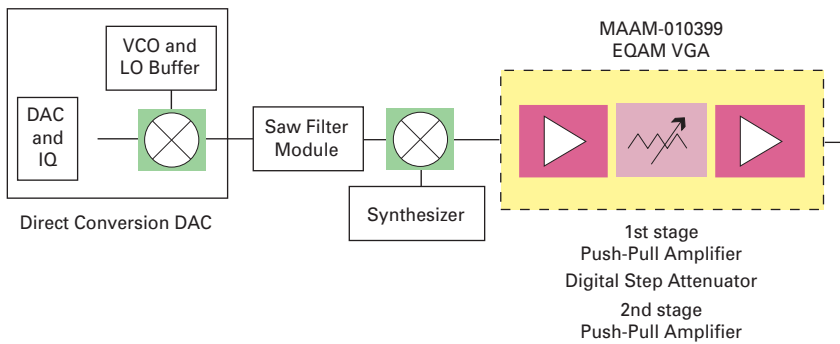

## MoCA-Enabled Set-Top Box Front End

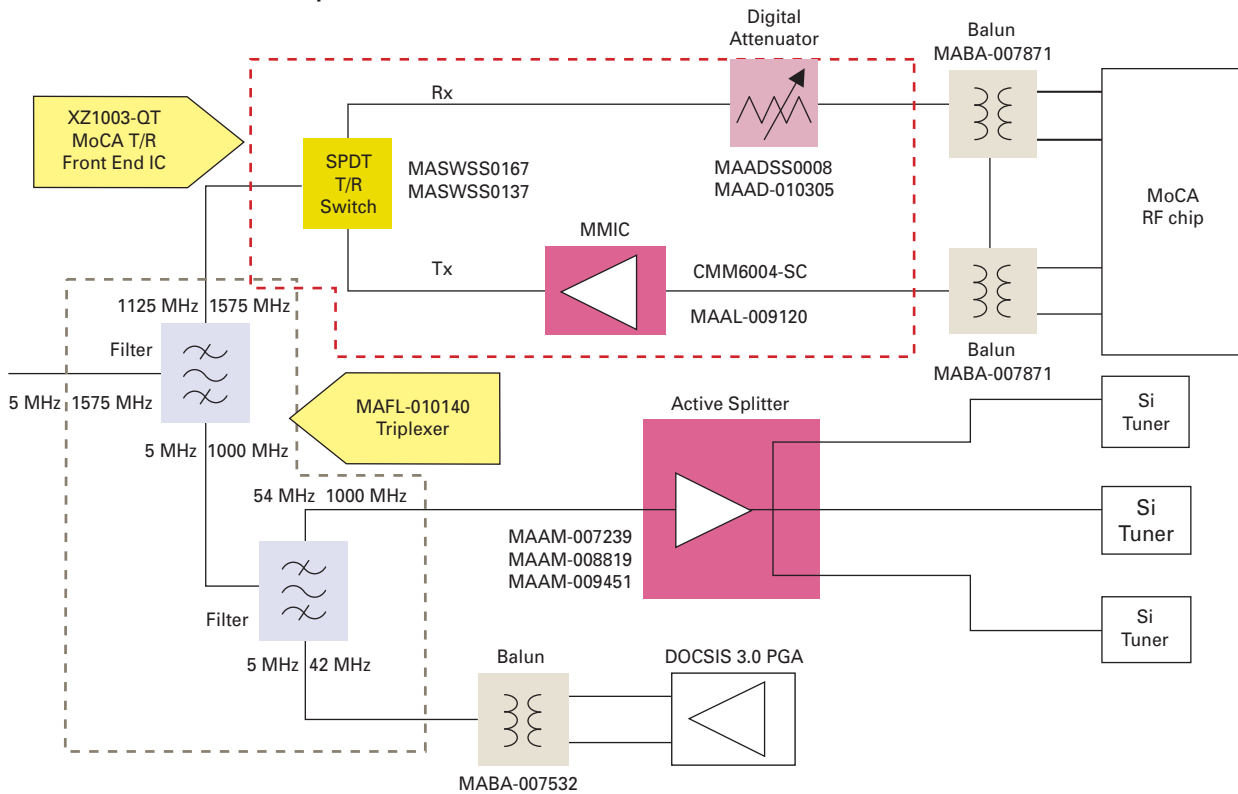

Typical Line Amplifier Architecture

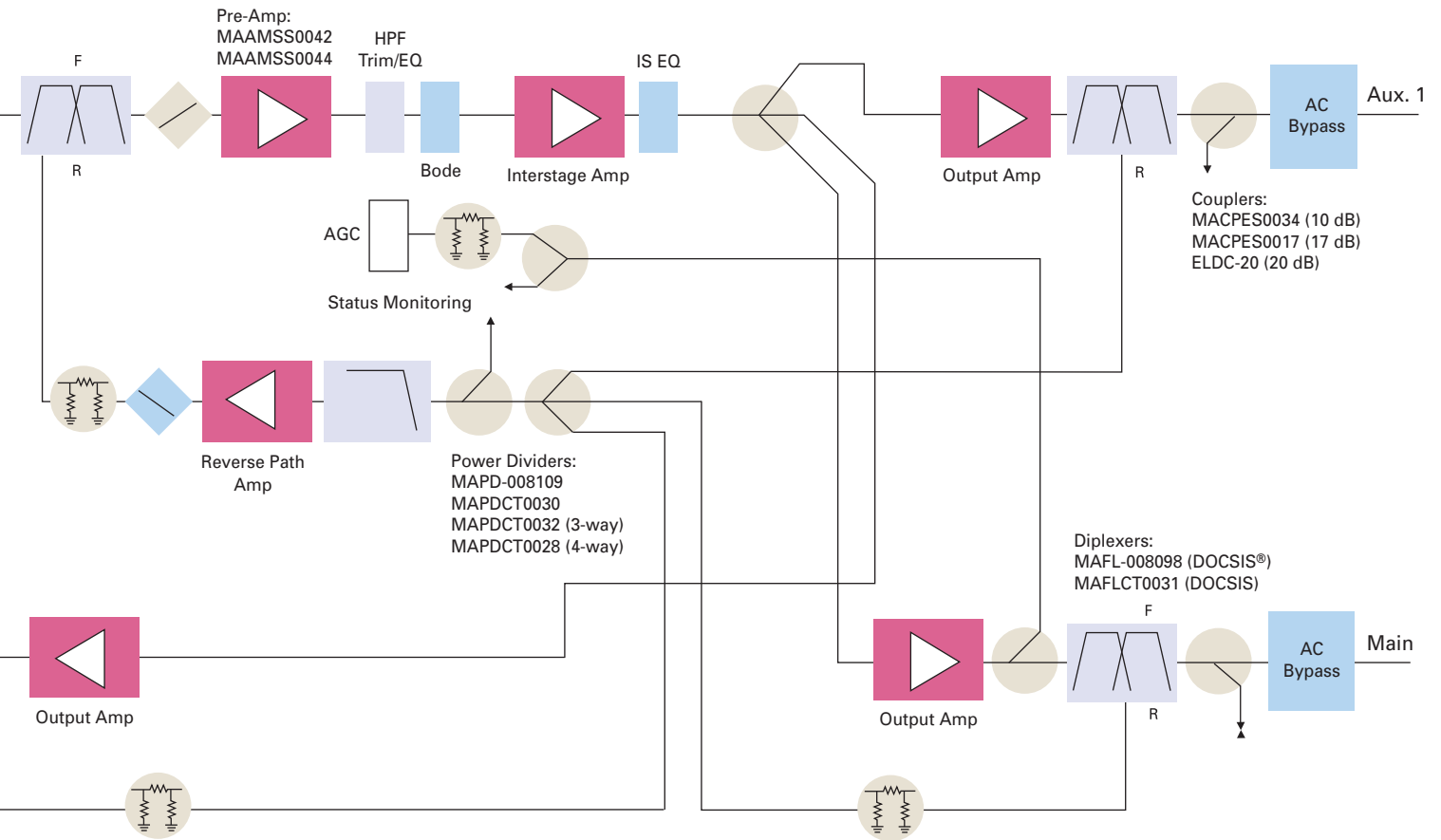

FTTx Video Amplifier with MoCA

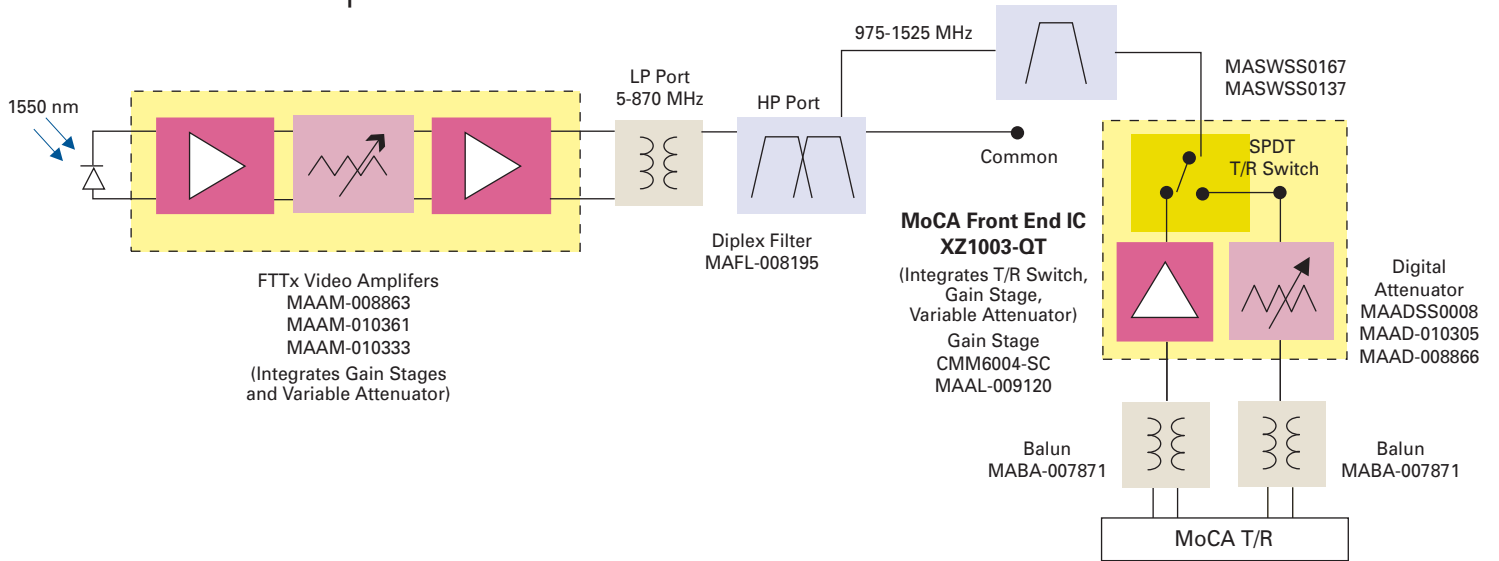

# Optoelectronics



MACOM offers the industry's largest portfolio of modulator drivers and transimpedance amplifiers for line and client side 10G, 40G and 100G optical communications systems. Our products leverage GaAs pHEMT and InP technologies to achieve market leading performance with minimum size. Our experienced design team works in close collaboration with leading customers to develop products which offer the optimum tradeoff between performance, power, size and cost. The explosion in data communications due to smartphone proliferation, video on demand, cloud computing, and other data-centric applications has forced telecommunication companies to migrate their core fiber optic networks from 10 Gbps to both 40 Gbps and 100 Gbps to increase capacity without the expense of laying additional fiber. This transition is enabled using complex modulation schemes to increase bandwidth efficiency and reduce the cost per bit. The analog electronics that interface the digital domain to the optical domain are a key building block in these systems.

## MACOM Modulator Driver Amplifiers

The modulator driver amplifier line includes Electro-absorption (EA) modulator drivers for low cost, short range, datacom applications, as well as high voltage Mach Zehnder (MZ) drivers for metro and long haul telecoms systems.

Some key features of the MACOM modulator drivers include:

- Optional differential inputs for reduced cross-talk and improved noise immunity
- Optional differential outputs for use with InP MZ modulators
- Single- and multi-channel solutions
- Low power dissipation
- Choice of die, surface mount packages and GPPO solutions

## MACOM Transimpedance Amplifiers (TIA)

Our Optoelectronics product line also includes a wide range of transimpedance amplifiers (TIA) for 10G, 40G and 100G fiber optic receivers. The family includes linear TIAs for coherent receivers and limiting TIAs for non-coherent receivers. These parts feature market leading gain and power dissipation. They are available in die form for integration with photo-detectors in an optical sub-assembly.

The key features of the MACOM TIA family are:

- Linear and limiting TIAs for line and client side 10G, 40G and 100G systems
- High transimpedance gain — up to 6 k $\Omega$
- Low power dissipation — <0.4 W
- Optional closed loop gain control
- Integrated DC offset cancellation

## MACOM Limiting Amplifiers

Our Optoelectronics product family includes limiting amplifiers for non-coherent 40G receivers. Limiting amplifiers are used to further amplify the output of a transimpedance amplifier prior to the digital SERDES (Serializer-Deserializer). The limiting amplifier is required to maintain a constant output voltage over a wide range of input voltages with minimal distortion.

Key features of the MACOM limiting amplifiers are:

- Differential inputs and outputs
- Wide input voltage range
- Crossing control
- Built-in closed loop AGC
- QFN style surface mount package







## Integrated Modules and Discrete Components for Radar and EW Applications

Aerospace and defense applications require a diverse suite of RF components that support a broad range of system architectures. From military communications to radar and sensing to electronic warfare, today's battlefield systems require high performance and the utmost in reliability and affordability to provide our warfighters with the tools they deserve. MACOM has supported the demanding needs of aerospace and defense for more than 60 years. Our engineers understand and deliver the performance that keeps our warfighters safe. MACOM offers a broad range of products and technical capabilities that meet today's aerospace and defense requirements to support systems with both standard and custom solutions.

MACOM uses high volume, dual use processes to create aerospace and defense applications:

- Si, GaAs and AlGaAs diodes
- GaAs MESFET and pHEMT-based MMICs
- Hybrid components—both both passive and active
- Hermetic and printed circuit board-based modules and assemblies

Our extensive design experience, coupled with our assembly and automated test capability, makes MACOM uniquely qualified to address the most demanding aerospace and defense specifications.

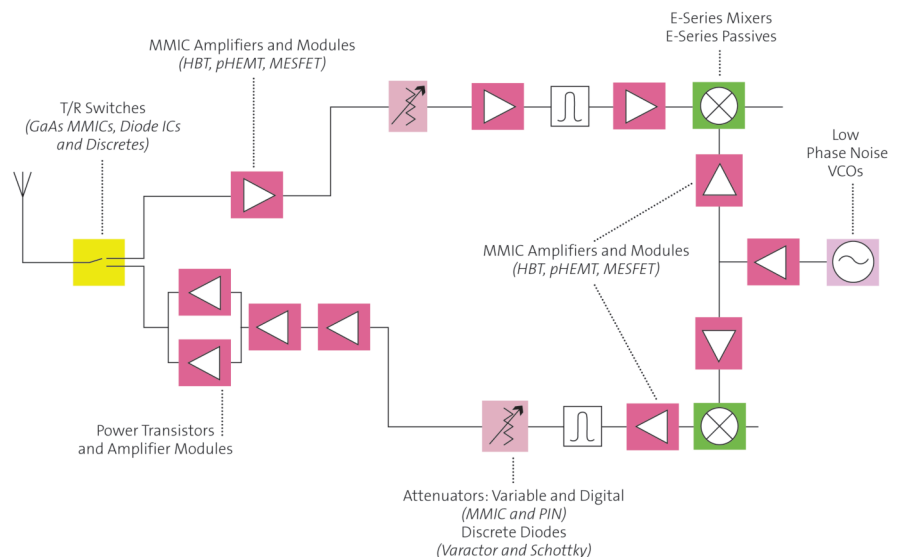
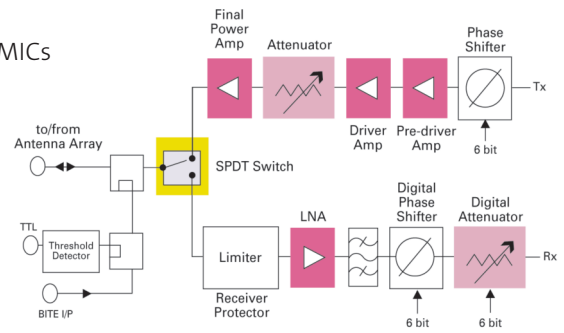

# Amplifiers



MACOM amplifiers are used extensively in commercial and military electronics applications. We produce low noise amplifiers (LNA), power amplifiers (PA), driver amplifiers and wideband amplifiers ranging from 50 MHz to 77 GHz. Our products are your ideal choice for voice, data and point-to-point applications, for the consumer and military markets.

- Cordless and mobile phones
- Infrastructure cellular base stations for
  - GSM
  - CDMA
  - PHS
  - UMTS
- Satellite radios
- Mobile GPS radios
- VSAT
- CATV and broadband
- WLAN cards and access points
- Aerospace and defense products
- Bluetooth
- RFID

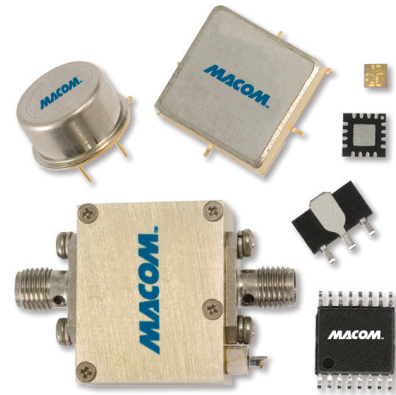

## Broadband Amplifiers

Frequency (MHz)	Part Number	Gain (dB)	NF (dB)	Output P1dB (dBm)	Output IP3 (dBm)	Voltage (Volts)	Current (mA)	Package
<b>Die Products</b>								
0 - 6000	CGB7001-BD-000V	20.5	3.3	14.2	28	5	35	Die
0 - 6000	CGB7003-BD-000V	20.7	2.9	16.6	31.5	5	50	Die
0 - 6000	CGB7004-BD-000V	16.5	3.6	17	32	5	62	Die
0 - 6000	CGB7005-BD-000V	21	3.2	17.6	32.5	5	63	Die
0 - 6000	CGB7006-BD-000V	15.2	4.1	18	33.5	8	64	Die
0 - 6000	CGB7007-BD-000V	19	4.5	18.8	34	8	67	Die
0 - 6000	CGB7008-BD-000V	21.2	3.2	18.8	33.5	8	64	Die
0 - 6000	CGB7009-BD-000V	16.8	3.9	19.2	35.3	8	73	Die
0 - 6000	CGB7010-BD-000V	21.5	3.2	20	35.5	8	75	Die
0 - 6000	CGB7011-BD-000V	21.7	3.4	21	36	8	82	Die
0 - 6000	CGB7012-BD-000V	15.7	4.3	20.3	36	8	86	Die
0 - 8000	CGB7014-BD-000V	24.5	3.5	20.3	36	8	80	Die
0 - 6000	CGB7015-BD-000V	23	4	21.1	37	8	92	Die
0 - 6000	CGB7016-BD-000V	22.4	3.8	18.4	34	5	78	Die
0 - 8000	CGB7017-BD-000V	23.1	3.3	18.2	33.8	5	70	Die
<b>200 - 3000</b>	<b>MAAM02350</b>	<b>17</b>	<b>3.7</b>	<b>14</b>	<b>24</b>	<b>6</b>	<b>65</b>	<b>Die</b>
2000 - 9000	CMM-9-BD-000V	14.5	5.5	17	27	6	80	Die
2000 - 18000	CMM1100-BD-000V	17	3.5	16	33	5	100	Die
2000 - 18000	CMM4000-BD-000V	8.5	4.5	19	29	5	115	Die
2000 - 22000	CMM0014-BD-000V	11	5	24	36	8	300	Die
2000 - 22000	CMM0015-BD-000V	10	6.5	28	35	12	350	Die
2000 - 22000	CMM0016-BD-000V	9	7	29	37	11.5	690	Die
<b>Packaged Products</b>								
0 - 6000	CGB7001-SC-0G0T	20.5	3.3	14.2	28	5	35	SOT-89
0 - 6000	CGB7003-SC-0G0T	20.7	2.9	16.6	31.5	5	50	SOT-89
0 - 6000	CGB7004-SC-0G0T	16.5	3.6	17	32	5	62	SOT-89
0 - 6000	CGB7005-SC-0G0T	21	3.2	17.6	32.5	5	63	SOT-89
0 - 6000	CGB7006-SC-0G0T	15.2	4.1	18	33.5	8	64	SOT-89
0 - 6000	CGB7007-SC-0G0T	19	4.5	18.8	34	8	67	SOT-89
0 - 6000	CGB7008-SC-0G0T	21.2	3.2	18.8	33.5	8	64	SOT-89
0 - 6000	CGB7009-SC-0G0T	16.8	3.9	19.2	35.3	8	73	SOT-89
0 - 6000	CGB7010-SC-0G0T	21.5	3.2	20	35.5	8	75	SOT-89
0 - 6000	CGB7011-SC-0G0T	21.7	3.4	21	36	8	82	SOT-89
0 - 6000	CGB7012-SC-0G0T	15.7	4.3	20.3	36	8	86	SOT-89
0 - 8000	CGB7014-SC-0G0T	24.5	3.5	20.3	36	8	80	SOT-89
0 - 6000	CGB7015-SC-0G0T	23	4	21.1	37	8	92	SOT-89
0 - 6000	CGB7016-SC-0G0T	22.4	3.8	18.4	34	5	78	SOT-89
0 - 8000	CGB7017-SC-0G0T	23.1	3.3	18.2	33.8	5	70	SOT-89
2 - 2400	A33-1	9	4	6	19	15	19	TO-8, SMT, SMA
2 - 2400	A35-1	9	4.2	9.5	23	15	26	TO-8, SMT, SMA
100 - 2600	A36-2	15	7	14	30	15	63	TO-8, SMT, SMA
20 - 2700	MAAM-007501-SA2002	11.5	2.5	27	40	9	165	TO-8, SMT, SMA
<b>200 - 3000</b>	<b>MAAM02350-A2</b>	<b>18</b>	<b>4</b>	<b>14</b>	<b>24</b>	<b>6</b>	<b>65</b>	<b>CR-3</b>
100 - 3200	A43	11.5	7	8.5	21	15	45	TO-8, SMT, SMA
4000 - 20000	MAAM-011101	12	4	18	30	12	45	1.5 x 1.2 mm TDFN-12

Note: Part numbers are RoHS compliant ♦ indicates non-RoHS compliant

Blue listings indicate standard stock items widely available from our franchised distribution partners.

Detailed specifications for our standard parts can be found quickly on our website at [macomtech.com](http://macomtech.com) by typing the part number into the search box.

All specifications are subject to change.



## CATV Amplifiers and Active Splitters

Frequency (MHz)	Part Number	Description	Gain (dB)	N.F. (dB)	Output P1dB	CTB (dBm)	CSO (dBm)	Channel Loading (dBmV/Ch)	Bias (V)	Current (mA)	Package
<b>Amplifiers</b>											
35 - 350	PAW1027 ♦	50 ohm hybrid	38.5	3.7	—	-59	-59	46/60	24	300	SOT115J
35 - 500	PAW1027-1 ♦	50 ohm hybrid	38	4.5	—	-59	-59	46/60	24	300	SOT115J
45 - 1000	MAAM-009634	Push-Pull Line Amp	24	4	26	-70	-70	44/79	24	265	TSSOP-16
45 - 1200	MAAM-010355	Pwr Doubler Line Amp	23	4	30.8	-73	-76	59/79	24	465	TSSOP-16
50 - 3000	CMM6004-SC	High Dynamic Range	14.5	2.1	23.5	—	—	—	3 - 5	150	SOT-89
50 - 1005	MAAM-007724	LNA	12.2	3.3	24	-78	-78	13/135	5	190	4 mm PQFN-20
50 - 1000	MAAM-007796	LNA	21	3.8	20	-70	-70	20/132	5	160	4 mm PQFN-20
50 - 1000	MAAM-007807	LNA	9	3.8	18	-75	-65	15/132	5	60	SOT-89
50 - 1000	MAAM-009100	LNA	13.8	3	18	63	63	30/132	5	105	SOT-89
50 - 1000	MAAM-009633	LNA	17	1.9	23	-75	-60	30/132	8	120	SOT-89
50 - 1000	MAAMSS0041	LNA	14.8	2.7	23	-80	-70	23/132	5/8	100	SOT-89
50 - 1000	MAAMSS0042	LNA	15	3	21	-70	-70	30/132	5	110	SOT-89
50 - 1000	MAAMSS0044	LNA	12.5	3.7	24	75	85	34/79	5	225	4 mm PQFN-20
50 - 1000	MAAMSS0060	LNA	17	1.8	23	-75	-60	30/132	5/8	120	SOT-89
50 - 1000	MAAM-009455	Gain Block	20.5	5.5	26	-70	-70	39/77	8	325	4 mm PQFN-20
50 - 1000	MAAM-010144	Gain Block	20.5	5.5	26	-70	-70	39/78	8	325	TSSOP-16
50 - 1000	MAAM-010373	LNA	22	2.2	25	-74	-62	33/80	8	148	SOT-89
50 - 1100	MAAM-010399	VGA	28	5	28	-78	-78	39/77	6	800	5x7 mm PQFN-40
50 - 2700	MAAM-011117	LNA	16	2.7	19.5	-75	-65	15/79	5	85	2 mm PDFN-8
100 - 3500	MAAL-010704	LNA	16	0.8	18	—	—	—	3/5	100	SOT-363

Frequency (MHz)	Part Number	Description	Gain (dB)	Noise Figure (dB)	Output P1dB (dBm)	OIP2 (dBm)	OIP3 (dBm)	64 QAM MER Pwr (dBmV)	Bias (V)	Current (mA)	Package
<b>Reverse Path Amplifiers</b>											
5 - 300	MAAM-011122	Docsis 3.1	39	3	27	70	42	35/72	8	280	7 mm PQFN-48

Frequency (MHz)	Part Number	Description	Gain (dB)	N.F. (dB)	Output P1dB	CTB (dBm)	CSO (dBm)	Channel Loading (dBmV/Ch)	Bias (V)	Current (mA)	Package
<b>Active Splitter Modules</b>											
50 - 1100	MAAM-007239	3 splits	6	4.5	17	-77	-65	15/132	5	125	3 mm PQFN-16
50 - 1100	MAAM-007805	2 splits	8.5	4	17	-75	-60	15/132	5	100	3 mm PQFN-12
50 - 1100	MAAM-008818	2 splits	3.6	2.6	9	-63	-60	15/132	5	120	2 mm PDFN-8
50 - 1100	MAAM-008819	3 splits	2.5	3.8	8.5	-63	-60	15/132	5	120	2 mm PDFN-8
50 - 1100	MAAM-008820	4 splits	3	3.8	10	-63	-60	15/132	5	120	3 mm PQFN-12
<b>50 - 1100</b>	<b>MAAM-008821</b>	<b>5 splits</b>	<b>3.5</b>	<b>3.8</b>	<b>9</b>	<b>-70</b>	<b>-60</b>	<b>15/132</b>	<b>5</b>	<b>120</b>	<b>3 mm PQFN-12</b>
50 - 1100	MAAM-008822	3 splits	1/3	4.5	7.5/11	-63	-60	23.5/135	5	120	2 mm PDFN-8

<b>Default-On Active Splitters</b>											
Frequency (MHz)	Part Number	Description	Gain (dB)	N.F. (dB)	Output P1dB	CTB (dBm)	CSO (dBm)	Channel Loading (dBmV/Ch)	Bias (V)	Current (mA)	Package
50 - 1100	MAAM-009879	2 splits	3	4.5	6	-70	-60	15/132	5	100	3 mm PQFN-12
50 - 1100	MAAM-009450	3 splits	3	3.8	7	-65	-65	15/132	5	100	3 mm PQFN-12
50 - 1100	MAAM-009778	4 splits	2.5	4.5	6	-65	-60	15/132	5	100	3 mm PQFN-12
50 - 1100	MAAM-009779	5 splits	1.5	4.5	6	-65	-60	15/132	5	100	3 mm PQFN-12
50 - 1100	MAAM-010263	6 splits	3	4.5	6	-65	-60	15/132	5	140	4 mm PQFN-24
50 - 1100	MAAM-010237	8 splits	3	4.5	25	-65	-60	15/135	5	140	4 mm PQFN-24
50 - 1100	MAAM-009451	3 splits	2.5	4.5	—	-70	-68	15/135	3.3	90	2 mm PDFN-8
50 - 1100	MAAM-009452	4 splits	2.5	3.8	5	-65	-65	15/132	3.3	120	3 mm PQFN-12
50 - 1100	MAAM-009811	2 splits	2.5	4	—	-70	-68	15/135	3.3	90	2 mm PDFN-8
950 - 2150	MAAM-008970	2 splits	4.8	5	7	-60	-68	15/135	3 - 5	60	3 mm PDFN-12

Note: Part numbers are RoHS compliant ♦ indicates non-RoHS compliant

Blue listings indicate standard stock items widely available from our franchised distribution partners.

Detailed specifications for our standard parts can be found quickly on our website at [macomtech.com](http://macomtech.com) by typing the part number into the search box.

## CATV Amplifiers and Active Splitters (continued)

Frequency (MHz)	Part Number	Description	Gain (dB)	EIN (PA/rHz)	Gain Range (dB)	CTB (dBm)	CSO (dBm)	Channel Loading (dBmV/Ch)	Bias (V)	Current (mA)	Package
<b>FTTx Amplifiers</b>											
50 - 1000	MAAM-008863	FTTx VGA	35	4.8	25	-61	-62	20/79	5	220	4 mm PQFN-2
50 - 1000	MAAM-010333	FTTx VGA	34	3.2	27	-68	-65	24/79	5	224	4 mm PQFN-24

## CATV MoCA Front End ICs

Frequency (MHz)	Part Number	TxP1dB (dBm)	Tx Gain (dB)	TxOIP3 (dBm)	Rx Gain (dB)	Icc (mA)	Vd (Volts)	Package
775 - 1525	XZ1003-QT	21.5	16/13/10	36	-0.7/-15.8	200	3.3 - 5	3 mm QFN-16
475 - 0625	XZ1004-QT	21.5	17/14	34.5	-0.8/-15.3	200	3.3 - 5	3 mm QFN-16

## Driver Amplifiers

Frequency (MHz)	Part Number	Gain (dB)	NF (dB)	Output P1dB (dBm)	Output IP3 (dBm)	Voltage (Volts)	Current (mA)	Package
<b>250 - 2500</b>	<b>MAAM-009286</b>	<b>15.5</b>	<b>3.5</b>	<b>27</b>	<b>42</b>	<b>5</b>	<b>160</b>	<b>SOT-89</b>
<b>250 - 2500</b>	<b>MAAM-009560</b>	<b>15.5</b>	<b>3.5</b>	<b>28.5</b>	<b>42</b>	<b>5</b>	<b>230</b>	<b>SOT-89</b>
<b>0 - 2800</b>	<b>CGB8001-SC-0G0T</b>	<b>15.5</b>	<b>3.9</b>	<b>27</b>	<b>—</b>	<b>5</b>	<b>100</b>	<b>SOT-89</b>
<b>250 - 3000</b>	<b>MAAM-009563</b>	<b>19.5</b>	<b>6</b>	<b>31</b>	<b>47</b>	<b>5</b>	<b>510</b>	<b>SOT-89</b>
40500 - 43500	MAAM-010513	23	—	23	32	4	400	4 mm laminate

## Low Noise Amplifiers

Frequency (MHz)	Part Number	Gain (dB)	NF (dB)	Output P1dB (dBm)	Output IP3 (dBm)	Voltage (Volts)	Current (mA)	Package
<b>Die Products</b>								
1200 - 1750	MAAM12000	26	1.25	14	24	5	80	Die
20000 - 40000	XL1000-BD	20	3	—	—	3/5	35/50	Die
<b>Packaged Products</b>								
10 - 100	AM-162-PIN	12.5	1.5	15	30	15	11	TO-8-1
10 - 100	AMS-162-PIN	12.5	1.5	15	30	15	11	SF-1
5 - 200	A71	18	2.1	-2.5	10	15	9	TO-8, SMT, SMA
10 - 200	A80-1	27.3	2	16	28	15	30	TO-8, SMT, SMA
10 - 250	A231	26	1.7	10	22	5	16	TO-8, SMT, SMA
10 - 250	A70	8	1.6	8	24	15	10	TO-8, SMT, SMA
10 - 250	A70-1	8	1.8	14	28	15	15	TO-8, SMT, SMA
10 - 250	A70-2	8	2.2	19	38	15	25	TO-8, SMT, SMA
5 - 500	A1	16	2.4	-1	11	15	9	TO-8, SMT, SMA
10 - 500	A531	31.7	2	2.5	14	5	17	TO-8, SMT, SMA
5 - 500	A75	21	2.1	9	21	15	24	TO-8, SMT, SMA
10 - 500	A75-3	20.5	1.7	3	16	15	14	TO-8, SMT, SMA
20 - 500	A80	29	2.3	14.3	27	15	45	TO-8, SMT, SMA
<b>400 - 500</b>	<b>MAAL-008624</b>	<b>21</b>	<b>0.9</b>	<b>—</b>	<b>28</b>	<b>5</b>	<b>60</b>	<b>SOIC-8</b>
<b>800 - 1000</b>	<b>MAAL-008091</b>	<b>15</b>	<b>1.2</b>	<b>16.5</b>	<b>30</b>	<b>5</b>	<b>60</b>	<b>SOIC-8</b>
5 - 1200	SMA21-1	15.5	2.4	-1	11	15	10	TO-8, SMT, SMA

(continued on page 14)

## Low Noise Amplifiers (continued)

Frequency (MHz)	Part Number	Gain (dB)	NF (dB)	Output P1dB (dBm)	Output IP3 (dBm)	Voltage (Volts)	Current (mA)	Package
100 - 1200	A1212	14	1.8	19	29	5	70	TO-8, SMT, SMA
<b>500 - 1600</b>	<b>MAAL-010705</b>	<b>21</b>	<b>0.5</b>	<b>18.5</b>	<b>32</b>	<b>4</b>	<b>60</b>	<b>2 mm PDFN-8</b>
<b>1550 - 1600</b>	<b>MAALSS0042</b>	<b>27</b>	<b>1.15</b>	<b>1</b>	<b>13</b>	<b>5</b>	<b>20</b>	<b>SOIC-8</b>
<b>1500 - 1600</b>	<b>MAALSS0044</b>	<b>21</b>	<b>1.55</b>	<b>6</b>	<b>19</b>	<b>5</b>	<b>8</b>	<b>SOIC-8</b>
1200 - 1750	MAAMI2000-A1	26	1.35	14	24	5	80	CR-3, CR-10
100 - 2000	A32	13	2.1	22	32	15	92	TO-8, SMT, SMA
<b>1800 - 2000</b>	<b>PA2001</b> ♦	<b>21</b>	<b>2</b>	<b>30.3</b>	<b>46.5</b>	<b>12</b>	<b>345</b>	<b>Flange Mount Carrier</b>
1400 - 2000	MAALSS0048	18	1.6	1	13	3	6.5	SOT-26
<b>1700 - 2000</b>	<b>MAAL-007673</b>	<b>20</b>	<b>1.65</b>	<b>7</b>	<b>19</b>	<b>5</b>	<b>8</b>	<b>SOIC-8</b>
<b>1700 - 2000</b>	<b>MAAM12031</b> ♦	<b>20</b>	<b>1.65</b>	<b>7</b>	<b>19</b>	<b>5</b>	<b>8</b>	<b>SOIC-8</b>
<b>1400 - 2000</b>	<b>MAAMSS0045</b>	<b>14</b>	<b>1.4</b>	<b>16</b>	<b>29</b>	<b>5</b>	<b>45</b>	<b>SOIC-8</b>
500 - 3000	MAAL-007304	25.5	.7	7	19	3	11.5	SOT-26
<b>70 - 3000</b>	<b>MAAL-010200</b>	<b>11</b>	<b>1.4</b>	<b>18</b>	<b>36</b>	<b>3</b>	<b>77</b>	<b>SOT-89</b>
<b>70 - 3000</b>	<b>MAAL-009120</b>	<b>11</b>	<b>1.4</b>	<b>18</b>	<b>35</b>	<b>3</b>	<b>80</b>	<b>SC-70</b>
<b>100 - 3500</b>	<b>MAAL-010704</b>	<b>14</b>	<b>0.84</b>	<b>19.1</b>	<b>34.5</b>	<b>3</b>	<b>60</b>	<b>SC-70</b>
1000 - 4000	A4011	15.5	2	18.3	29	5	65	TO-8, SMT, SMA
<b>1400 - 4000</b>	<b>MAAL-010706</b>	<b>17.5</b>	<b>0.6</b>	<b>19.1</b>	<b>34.5</b>	<b>4</b>	<b>60</b>	<b>2 mm DFN</b>
5150 - 5850	MAMF-010614	12	2.2	-3	5	3	10	2 mm STQFN-12
2000 - 6000	A6011	14.8	1.5	18	30	5	58	TO-8, SMT, SMA
3500 - 8000	XL1007-QT	12	2	13	25	3	44	3 mm QFN-16
8000 - 12000	MAAL-010528	20	1.6	14	26	4	60	3 mm QFN-16
20000 - 38000	XL1010-QT	17	3	—	—	4	45	3 mm QFN-16

## Power Amplifiers

Frequency (MHz)	Part Number	Gain (dB)	NF (dB)	Output P1dB (dBm)	Output IP3 (dBm)	Voltage (Volts)	Current (mA)	Package
<b>Die Products</b>								
27 - 32	XPI026-BD	21	—	33 (Psat)	40	5.5	900	Die
27 - 31	XPI027-BD	21	—	35.5 (Psat)	43	5.5	2000	Die
35 - 43	XPI005-BD	26	—	24 (Psat)	—	4.5	500	Die
<b>Packaged Products</b>								
5 - 100	A101	17	3	23	36	12	105	TO-8, SMT, SMA
35 - 350	PAW1027 ♦	38.5	3.7	31	43	24	300	SOT115J
10 - 500	PA511	12.7	4.6	24.8	40	15	118	TO-8, SMT, SMA
10 - 500	PA512	18	5.2	27.5	40	15	200	TO-8, SMT, SMA
35 - 500	PAW1027-1	38	4.2	31	43	24	300	SOT115J
10 - 1000	SMRA69	25	4.5	23	34	15	130	TO-8B, SMT, SMA
1435 - 1525	AM42-0054	26	—	—	—	—	—	R380
1600	XP9003-MB	38	—	43	—	9	2900	40 x 36 mm
1710 - 1910	AM40-0023	11	0.9	-13	—	—	—	CR-5
<b>1800 - 2000</b>	<b>PA2003</b> ♦	<b>21</b>	<b>2.5</b>	<b>33.5</b>	<b>49</b>	<b>12</b>	<b>495</b>	<b>Flange Mount Carrier</b>
1800 - 2000	AM55-0004	24	—	24	—	—	—	SSOP-28
200 - 2000	PA2010	10	5	25.5	33	15	179	TO-8, SMT, SMA
200 - 2000	PA38	10	4	23	34	15	150	TO-8, SMT, SMA
<b>1800 - 2000</b>	<b>PA2001</b> ♦	<b>21</b>	<b>2</b>	<b>30.3</b>	<b>46.5</b>	<b>12</b>	<b>345</b>	<b>Flange Mount Carrier</b>
2200 - 2400	AM42-0055	29	—	—	—	—	—	R380
<b>2400 - 2500</b>	<b>MAAPSS0075</b>	<b>29.5</b>	<b>—</b>	<b>26.5</b>	<b>52</b>	<b>3.3</b>	<b>185</b>	<b>3 mm PQFN-12</b>
2400 - 2500	MAAP-008516	30	—	23	—	3.3	80	2.5 x 2 mm PQFN-14
200 - 2600	PA38-2	8.5	4.5	23.5	33	15	150	TO-8, SMT, SMA
20 - 2700	MAAM-007501-SA2002	11.5	2.5	27	40	9	165	TO-8, SMT, SMA
500 - 3000	MAAP-010168	24	—	41 (Psat)	—	10	3500	Flange Mount Carrier

## Power Amplifiers (continued)

Frequency (MHz)	Part Number	Gain (dB)	NF (dB)	Output P1dB (dBm)	Output IP3 (dBm)	Voltage (Volts)	Current (mA)	Package
3100 - 3500	MAAP-010171	27	—	39 (Psat)	—	9	1000	5 mm QFN-20
1000 - 4000	PA48	16	5.5	24	34	15	225	TO-8B, SMT, SMA
2000 - 6000	MAAP-010169	18	—	41 (Psat)	—	10	3500	Flange Mount Carrier
5600 - 7100	XP1039-QJ	17	—	33	48	7	1350	6 mm QFN-24
7100 - 8500	XP1050-QJ	15.5	—	33	47	7	1350	6 mm QFN-24
5900 - 9500	XP1035-QH	26	—	29	39	6	500	4 mm QFN-24
10000 - 13000	MAAP-008924	21	7	31	42	6	1000	5 mm QFN-20
12700 - 13300	MAAP-010516	26	7	34	42	6	1200	5 mm QFN-24
14000 - 14500	AM42-0002	22	—	29.5	39	9	800	CR-15
14000 - 14500	AM42-0007	22	—	32	41	9	1000	CR-15
14400 - 15400	MAAP-010517	24	7	34.5	42	6	1200	5 mm QFN-24
14400 - 15401	MAAP-010518	21	7	33.5	40	6	1200	5 mm QFN-24
12000 - 16000	XP1042-QT	21	—	25	38	5	500	3 mm QFN-16
12000 - 16000	XP1043-QH	21.5	—	30	41	7	700	4 mm QFN-24
37000 - 40000	XP1080-QU	25	—	27	38	4	1000	7 mm SMD-28
37000 - 40000	XP1031-QK	25	—	25	35.5	4	600	7 mm SMD-28
40500 - 43500	MAAP-010512	22	—	27	38	4	1117	7 mm laminate

## General

Frequency (MHz)	Part Number	Gain (dB)	NF (dB)	Output P1dB (dBm)	Output IP3 (dBm)	Voltage (Volts)	Current (mA)	Package
<b>Die Products</b>								
4000 - 11000	XB1007-BD	23	4.5	20	30	4	100	Die
10000 - 21000	XB1008-BD	18	5.5	20	30	4	100	Die
16000 - 30000	XB1004-BD	20/21	2.2/3.2	14/19	324/29	4/6	90/180	Die
35000 - 45000	XB1005-BD	19/23	2.7/3.7	13/16	23/26	3.5/4.5	50/154	Die
<b>Packaged Products</b>								
5 - 100	A101	17	3	23	36	12	105	TO-8, SMT, SMA
10 - 100	AM-162-PIN	12.5	1.5	15	30	15	11	TO-8-1, CONN
10 - 100	AMS-162-PIN	12.5	1.5	15	30	15	11	SF-1
15 - 100	AM05-0005	15	5	23	37	—	—	LGA-1
15 - 100	AM05-0006	10.6	5	23	40	—	—	LGA-1
5 - 200	A71	18	2.1	-2.5	10	15	9	TO-8, SMT, SMA
10 - 200	A80-1	27.3	2	16	28	15	30	TO-8, SMT, SMA
5 - 250	A74-1	31	4.5	8.5	21	15	40	TO-8, SMT, SMA
5 - 250	A75-2	21	4.2	8	19	15	24	TO-8, SMT, SMA
5 - 250	EA54	27	3.8	5	16	5	30	TO-5
10 - 250	A83-1	35.5	2.5	-1.5	9	15	31	TO-8, SMT, SMA
10 - 250	A181	16.5	3.8	22	35	15	95	TO-8, SMT, SMA
10 - 250	A231	26	1.7	10	22	5	16	TO-8, SMT, SMA
10 - 250	A70	8	1.6	8	24	15	10	TO-8, SMT, SMA
10 - 250	A70-1	8	1.8	14	28	15	15	TO-8, SMT, SMA
10 - 250	A70-2	8	2.2	19	38	15	25	TO-8, SMT, SMA
20 - 250	A70-3	8	2.8	21	40	15	37	TO-8, SMT, SMA
20 - 250	A81	25.5	3	17	28	15	35	TO-8, SMT, SMA
20 - 250	A81-1	25	2.5	13.5	27	15	25	TO-8, SMT, SMA
20 - 250	A82	25	2.8	20	31	15	50	TO-8, SMT, SMA

(continued on page 16)

Note: Part numbers are RoHS compliant ♦ indicates non-RoHS compliant

Blue listings indicate standard stock items widely available from our franchised distribution partners.

Detailed specifications for our standard parts can be found quickly on our website at [macomtech.com](http://macomtech.com) by typing the part number into the search box.

All specifications are subject to change.



## General Amplifiers (continued)

Frequency (MHz)	Part Number	Gain (dB)	NF (dB)	Output P1dB (dBm)	Output IP3 (dBm)	Voltage (Volts)	Current (mA)	Package
20 - 250	A82-1	19	2.8	15	26	15	50	TO-8, SMT, SMA
30 - 250	AM-119-PIN	8	2.5	21	35	15	50	TO-8-1, CONN
5 - 300	A78	14	3.5	19.5	35	15	65	TO-8, SMT, SMA
5 - 300	A79	14	4	22	38	15	88	TO-8, SMT, SMA
510 - 300	A87-2	16	2.9	11	24	5	15	TO-8, SMT, SMA
35 - 350	PAW1027 ♦	38.5	3.7	31	43	24	300	SOT115J
5 - 400	A56	26	5.5	13.5	27	15	69	TO-8, SMT, SMA
5 - 400	EA1	14	4.3	-4.5	13	15	10	TO-5
5 - 400	EA2	13.5	5.7	9	21	15	27	TO-5
10 - 400	A411	15.8	3	10	24	5	16	TO-8, SMT, SMA
10 - 400	A87	14	3.8	17.5	33	15	33	TO-8, SMT, SMA
10 - 400	A87-1	16	3.4	17	31	15	30	TO-8, SMT, SMA
10 - 400	MAAM-008199-000A51	15	2.7	-3.5	10	15	7	TO-8, SMT, SMA
5 - 500	A5	14.8	4.5	8.5	22	15	25	TO-8, SMT, SMA
5 - 500	A514	28	4	19	32	15	96	TO-8, SMT, SMA
5 - 500	A515	27.5	3.5	22	33	15	127	TO-8, SMT, SMA
5 - 500	A54	15.5	4	9	21	15	34	TO-8, SMT, SMA
5 - 500	A5-5	15.5	4	9	21	15	24	TO-8, SMT, SMA
5 - 500	A58	11.5	4	19	34	15	65	TO-8, SMT, SMA
5 - 500	A59	11.5	4.3	22	36	15	88	TO-8, SMT, SMA
5 - 500	A72	15	3.3	12.5	26	15	30	TO-8, SMT, SMA
5 - 500	A73	32	3.5	1.5	15	15	20	TO-8, SMT, SMA
5 - 500	A74	30	3	8.5	20	15	40	TO-8, SMT, SMA
5 - 500	A74-2	26	3.8	-1	10	5	13	TO-8, SMT, SMA
5 - 500	A76	28	3	14.7	28	15	62	TO-8, SMT, SMA
5 - 500	A76-1	27.5	3	12.7	26	5	47	TO-8, SMT, SMA
5 - 500	A77	16.5	4.5	16.5	30	15	50	TO-8, SMT, SMA
5 - 500	A88	18.7	6.5	20.5	30	15	79	TO-8, SMT, SMA
5 - 500	AM-123-PIN	10	5.5	18	30	15	62	FP-9, CONN
5 - 500	AM-131-PIN	10	5	19	35	15	65	TO-8-1
5 - 500	AM-143-PIN	15.8	2.5	6	20	15	13	TO-8-1, CONN
5 - 500	AM-147-PIN	17	3.4	20	32	15	52	TO-8-1, CONN
5 - 500	AM-151-PIN	12	4.3	22	36	15	88	TO-8-1, CONN
5 - 500	EA53-2	19	3.6	11	24	15	33	TO-5
5 - 500	EA54-2	29.5	4.5	9.5	20	15	55	TO-5
5 - 500	A1	16	2.4	-1	11	15	9	TO-8, SMT, SMA
5 - 500	A75	21	2.1	9	21	15	24	TO-8, SMT, SMA
5 - 500	RA89	26.5	3.7	21.5	35	15	130	TO-8B, SMT, SMA
5 - 500	MAAM-009503-AM147A	17	3.5	21	35	15	52	TO-8-1
10 - 500	A180	16.5	3.4	18	33	15	63	TO-8, SMT, SMA
10 - 500	A511	17	3.4	20	32	15	52	TO-8, SMT, SMA
10 - 500	A513	20	5.5	18	30	12	120	TO-8, SMT, SMA
10 - 500	A53	15	3	3.5	16	15	12	TO-8, SMT, SMA
10 - 500	A55	14.7	5	11	24	15	30	TO-8, SMT, SMA
10 - 500	A57	14.7	4.8	14	28	15	44	TO-8, SMT, SMA
10 - 500	AM-146-PIN	21	4.5	22	35	15	130	FP-9, CONN
10 - 500	MAAM-008200-000A83	30	3	-1	10	5	13	TO-8, SMT, SMA
10 - 500	A531	31.7	2	2.5	14	5	17	TO-8, SMT, SMA
10 - 500	A75-3	20.5	1.7	3	16	15	14	TO-8, SMT, SMA
10 - 500	PA511	12.7	4.6	24.8	40	15	118	TO-8, SMT, SMA
10 - 500	PA512	18	5.2	27.5	40	15	200	TO-8, SMT, SMA

## General Amplifiers (continued)

Frequency (MHz)	Part Number	Gain (dB)	NF (dB)	Output P1dB (dBm)	Output IP3 (dBm)	Voltage (Volts)	Current (mA)	Package
10 - 500	RA89-1	30	3.2	21.5	36	15	130	TO-8B, SMT, SMA
20 - 500	A81-2	24.5	3	15	28	15	29	TO-8, SMT, SMA
20 - 500	A81-3	17	4	8	20	15	29	TO-8, SMT, SMA
20 - 500	A80	29	2.3	14.3	27	15	45	TO-8, SMT, SMA
20 - 500	SMA80	29	2.3	14.3	27	15	45	TO-8, SMT, SMA
35 - 500	PAW1027-1	38	4.2	31	43	24	300	SOT115J
5 - 600	A77-1	16	5	16.5	30	15	50	TO-8, SMT, SMA
6 - 600	A5-6	16	4.5	8.5	21	15	24	TO-8, SMT, SMA
10 - 600	A67-1	15	3.7	17	30	15	36	TO-8, SMT, SMA
10 - 600	CA67-1	15	3.7	17	30	15	36	TO-8, SMT, SMA
100 - 600	AM-160-PIN	28.2	2.5	19	30	15	70	FP-9
100 - 600	AM-191-PIN	23.5	3	22	32	15	77	FP-2
5 - 700	A611	15	3.2	12.5	24	5	31	TO-8, SMT, SMA
10 - 700	A59-1	10.5	6	22	36	15	88	TO-8, SMT, SMA
10 - 800	A67	14	4	16	30	15	32	TO-8, SMT, SMA
100 - 800	A89	22	4.5	17.5	30	15	42	TO-8, SMT, SMA
5 - 1000	A11	14.7	3.1	-2	10	15	9	TO-8, SMT, SMA
5 - 1000	A11-2	16	2.5	-1	10	15	9	TO-8, SMT, SMA
5 - 1000	A63	16	3	4	15	15	14	TO-8, SMT, SMA
5 - 1000	AM-176-PIN	13.2	4	13	27	15	38	TO-8-1
5 - 1000	AM-182-PIN	28.2	3.5	10	20	15	44	TO-8-1
10 - 1000	A1021	26	3.8	14.5	26	5	60	TO-8, SMT, SMA
10 - 1000	A1031	28.5	2.7	10	22	5	36	TO-8, SMT, SMA
10 - 1000	A12	16	2.8	8	22	15	22	TO-8, SMT, SMA
10 - 1000	A17	12	6	15.3	27	15	44	TO-8, SMT, SMA
10 - 1000	A18-1	14.7	3.8	16	30	15	44	TO-8, SMT, SMA
0 - 1000	A19-1	11.5	5.5	22.5	35	15	90	TO-8, SMT, SMA
10 - 1000	A66-1	27.5	2.9	15	28	15	66	TO-8, SMT, SMA
10 - 1000	A66-3	26	3	3	13	5	16	TO-8, SMT, SMA
10 - 1000	AM-145-PIN	10.7	3	18	32	15	50	TO-8-1, CONN
10 - 1000	AM-177-PIN	12	6.5	22	35	15	105	TO-8-1
10 - 1000	AM-183-PIN	28.5	4	14	23	15	72	TO-8-1, CONN
10 - 1000	RA66	37	3.5	15.5	30	15	81	TO-8B, SMT, SMA
10 - 1000	RA69	25	4.5	23	34	15	130	TO-8B, SMT, SMA
5 - 1200	A21-1	15.5	2.4	-1	11	15	10	TO-8, SMT, SMA
10 - 1200	A1211	14	2.8	6	20	5	15.5	TO-8, SMT, SMA
10 - 1200	A64	26	3.4	8	20	15	35	TO-8, SMT, SMA
10 - 1200	A66	23.5	4	15	28	15	64	TO-8, SMT, SMA
10 - 1200	MAAM-008198-00A162	13	3.5	6	18	5	15	TO-8, SMT, SMA
100 - 1200	A1212	14	1.8	19	29	5	70	TO-8, SMT, SMA
2 - 1500	A25-1	13.5	3	9	22	15	25	TO-8, SMT, SMA
5 - 1500	A24	20	4.2	8	21	15	34	TO-8, SMT, SMA
5 - 1500	A25	10	6	9	21	15	24	TO-8, SMT, SMA
10 - 1500	A26	20.5	5	16	27	15	64	TO-8, SMT, SMA
10 - 1500	A27	8.5	7.5	15.5	28	15	50	TO-8, SMT, SMA
10 - 1500	A28	11	6	15	29	15	45	TO-8, SMT, SMA
10 - 1500	A28-2	14	3.5	10.5	24	5	27	TO-8, SMT, SMA

(continued on page 18)

Note: Part numbers are RoHS compliant ♦ indicates non-RoHS compliant

Blue listings indicate standard stock items widely available from our franchised distribution partners.

Detailed specifications for our standard parts can be found quickly on our website at [macomtech.com](http://macomtech.com) by typing the part number into the search box.

All specifications are subject to change.

## General Amplifiers (continued)

Frequency (MHz)	Part Number	Gain (dB)	NF (dB)	Output P1dB (dBm)	Output IP3 (dBm)	Voltage (Volts)	Current (mA)	Package
10 - 1500	A29-1	9	5.5	22	32	15	90	TO-8, SMT, SMA
300 - 1800	AM-153-PIN	12.4	2.5	7.5	17	15	13	TO-8-1
300 - 1800	AM-155-PIN	12.3	3.5	20	30	15	50	TO-8-1, CONN
10 - 2000	A31-1	11.5	3.5	-2	9	15	9	TO-8, SMT, SMA
10 - 2000	A33	9.5	4.5	3	15	15	14	TO-8, SMT, SMA
10 - 2000	A35	10	5	9	21	15	24	TO-8, SMT, SMA
10 - 2000	A37	10	6.8	15	28	15	47	TO-8, SMT, SMA
10 - 2000	A38	9.5	6.5	19	30	15	65	TO-8, SMT, SMA
10 - 2000	A39	7.5	8.5	22	34	15	90	TO-8, SMT, SMA
10 - 2000	AM-180-PIN	9.7	6	14.5	2.8	15	45	TO-8-1, CONN
10 - 2000	AM-184-PIN	20	5	11	21	15	52	TO-8-1, CONN
100 - 2000	A32-1	11.5	2.5	15.5	25	5	44	TO-8, SMT, SMA
100 - 2000	A34	16	5.5	7	18	15	35	TO-8, SMT, SMA
100 - 2000	A36	16.5	5.5	12	23	15	63	TO-8, SMT, SMA
100 - 2000	A32	13	2.1	22	32	15	92	TO-8, SMT, SMA
100 - 2000	RA36	24	5.5	13	22	15	76	TO-8B, SMT, SMA
200 - 2000	PA2010	10	5	25.5	33	15	179	TO-8, SMT, SMA
200 - 2000	PA38	10	4	23	34	15	150	TO-8, SMT, SMA
1800 - 2000	PA2003 ♦	21	2.5	33.5	49	12	495	Flange Mount Carrier
1800 - 2000	PA2001 ♦	21	2	30.3	46.5	12	345	Flange Mount Carrier
100 - 2300	A36-1	16.2	6	12	23	15	63	TO-8, SMT, SMA
2 - 2400	A33-1	9	4	6	19	15	19	TO-8, SMT, SMA
2 - 2400	A35-1	9	4.2	9.5	23	15	26	TO-8, SMT, SMA
0.01 - 2500	A3010	9.5	4.5	19	35	12	160	TO-8, SMA
100 - 2600	A36-2	15	7	14	30	15	63	TO-8, SMT, SMA
200 - 2600	PA38-2	8.5	4.5	23.5	33	15	150	TO-8, SMT, SMA
20 - 2700	MAAM-007501-SA2002	11.5	2.5	27	40	9	165	TO-8, SMT, SMA
1000 - 4000	A4012	18	3.5	15.5	26	5	65	TO-8, SMT, SMA
1000 - 4000	A45	17.5	4	19.5	29	15	120	TO-8, SMT, SMA
1000 - 4000	A45-1	17.5	4	13	26	5	65	TO-8, SMT, SMA
1000 - 4000	A4011	15.5	2	18.3	29	5	65	TO-8, SMT, SMA
1000 - 4000	PA48	16	5.5	24	34	15	225	TO-8B, SMT, SMA
1000 - 4000	RA46	25.5	4.5	19	30	12	175	TO-8B, SMT, SMA
2000 - 6000	A61	7.5	3.2	12.5	25	5	35	TO-8, SMT, SMA
2000 - 6000	A6011	14.8	1.5	18	30	5	58	TO-8, SMT, SMA
2000 - 6000	RA62	16	4	13	28	15	65	TO-8B, SMT, SMA
2000 - 6000	RA63-1	22	5.5	16	32	5	120	TO-8B, SMT, SMA
4000 - 11000	XB1007-QT	23	4.5	20	31	4	100	3 mm QFN-16
10000 - 21000	XB1008-QT	17	4.5	19	32	4	100	3 mm QFN-16
37000 - 40000	XB1014-QT	20	6	20	30	4	250	3 mm QFN-16

Note: Part numbers are RoHS compliant ♦ indicates non-RoHS compliant

Blue listings indicate standard stock items widely available from our franchised distribution partners.

Detailed specifications for our standard parts can be found quickly on our website at [macomtech.com](http://macomtech.com) by typing the part number into the search box.

All specifications are subject to change.

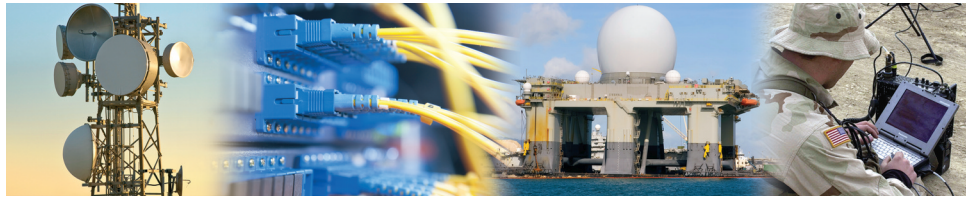

MACOM attenuators are used in various applications for automotive and wireless markets, including 75 ohm versions for CATV. We offer serial and parallel logic controlled digital attenuators and voltage variable analog attenuators (VVAs) that range from DC to 6 GHz.

- Cellular infrastructure
- Handset gain control
- Radar systems
- Satellite radios
- Test equipment

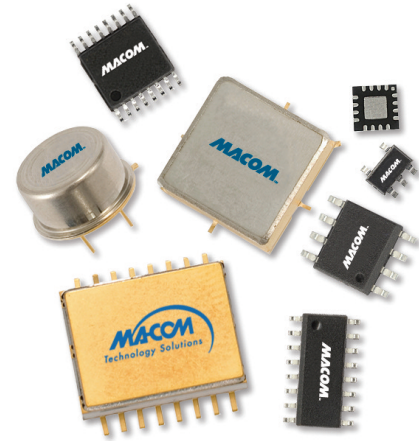



## Voltage Variable Attenuators

Frequency (MHz)	Part Number	Insertion Loss (dB)	Attenuator Range (dB)	Input IP3 (dBm)	Voltage (Volts)	Current (mA)	Package
<b>0 - 2000</b>	<b>MAAV-007941</b>	<b>3.2</b>	<b>12</b>	<b>36</b>	<b>-4</b>	<b>0.02</b>	<b>SOIC-8</b>
<b>0 - 2000</b>	<b>MAAVSS0005</b>	<b>3.2</b>	<b>12</b>	<b>36</b>	<b>-4</b>	<b>0.02</b>	<b>SOT-143</b>
0 - 2000	MAAVSS0004	7.2	35	36	-4	0.02	SOIC-14
<b>0 - 2000</b>	<b>MAAVSS0006</b>	<b>3.6</b>	<b>25</b>	<b>36</b>	<b>-3</b>	<b>0.025</b>	<b>SOT-25</b>
5 - 2000	G1*	2.5	25	—	+15	15	TO-8, SMT, SMA
5 - 2000	G2	2.6	23	—	+5	15	TO-8, SMT, SMA
5 - 3000	MA4P7455-1225T	1	30	43	—	—	SOT-25
5 - 3000	MADP-007167-12250T	2.8	25	50	—	—	SOT-25
50 - 1000	MAAV-007088-000100	2.8	42	34	—	—	SOW-16
100 - 2000	G30**	2.5	35	—	+15	10	TO-8, SMT, SMA
<b>500 - 2000</b>	<b>MAAVSS0008</b>	<b>2.8</b>	<b>39</b>	<b>28</b>	<b>+5</b>	<b>0.3</b>	<b>SOIC-8</b>
<b>500 - 2000</b>	<b>MAAV-008022</b>	<b>2.7</b>	<b>40</b>	<b>28</b>	<b>+3</b>	<b>0.05</b>	<b>SOIC-8</b>
<b>500 - 3000</b>	<b>MAAVSS0007</b>	<b>2.5</b>	<b>40</b>	<b>32</b>	<b>+5</b>	<b>0.05</b>	<b>SOIC-8</b>
500 - 4000	G40	2.5	25	—	+15	12	TO-8, SMT, SMA
600 - 1200	MA4VAT904-1061T	1	24	49	—	—	SOIC-8
600 - 1200	MA4VAT907-1061T	1	24	49	—	—	SOIC-8
600 - 2000	MA4VAT900-1277T	1	24	40	—	—	3 mm PQFN
800 - 1000	MAAV-007089-000100	4.2	35	35	—	30	SOW-16
800 - 1000	MAAV-007092-000100	3.6	38	40	—	30	CSP-8
1200 - 2500	MA4VAT2000-1277T	1.2	25	21	—	—	3 mm PQFN
1500 - 2500	MA4VAT2004-1061T	1.4	24	49	—	—	SOIC-8
1500 - 2500	MA4VAT2007-1061T	1.4	24	52	—	—	SOIC-8
1700 - 2000	MAAV-007090-000100	3.5	35	31	—	—	SOW-16
1700 - 2200	MAAV-007091-000100	2.9	33	31	—	30	CSP-8
<b>1800 - 2500</b>	<b>MAAVSS0001</b>	<b>2.4</b>	<b>42</b>	<b>32</b>	<b>+2.25</b>	<b>0.05</b>	<b>SOT-25</b>
5000 - 45000	MAAT-010521	2	40	30	-2	—	3 mm QFN-16

\*LG1 Linearizer is compatible with the G1 Attenuator. Yields linear attenuation (dB) for linear control voltage. Available in TO-8, SMT, SMA

\*\*LG30 Linearizer is compatible with the G30 Attenuator. Yields linear attenuation (dB) for linear control voltage. Available in TO-8, SMT, SMA

## Digital Attenuators

Frequency (MHz)	Part Number	Insertion Loss (dB)	Step Size (dB)	Attenuator Range (dB)	Input IP3 (dBm)	Package
<b>Packaged Products</b>						
<b>0 - 2000</b>	<b>MAATSS0015</b>	<b>1.5</b>	<b>1</b>	<b>15</b>	<b>50</b>	<b>SOIC-16</b>
<b>0 - 2000</b>	<b>MAADSS0009</b>	<b>1.6</b>	<b>2</b>	<b>30</b>	<b>50</b>	<b>SOIC-16</b>
0 - 2000	AT-232	2.5	2	30	50	CR-6
<b>0 - 2000</b>	<b>MAATSS0020</b>	<b>1.9</b>	<b>1</b>	<b>31</b>	<b>50</b>	<b>SSOP-20</b>
<b>0 - 2000</b>	<b>MAATSS0018</b>	<b>0.3</b>	<b>10</b>	<b>10</b>	<b>50</b>	<b>SOT-25</b>
<b>0 - 2000</b>	<b>MAADSS0008</b>	<b>0.3</b>	<b>15</b>	<b>15</b>	<b>50</b>	<b>SOT-25</b>
<b>0 - 2000</b>	<b>MAATSS0021</b>	<b>1.5</b>	<b>0.5</b>	<b>15.5</b>	<b>45</b>	<b>SOIC-16</b>
0 - 2000	AT-357 ♦	6.5	1	31	47	C-46
0 - 2000	AT15-0001	7.3	1	31	40	Ceramic
<b>0 - 3000</b>	<b>AT-213</b>	<b>2.5</b>	<b>1</b>	<b>15</b>	<b>50</b>	<b>CR-11</b>

Note: Part numbers are RoHS compliant ♦ indicates non-RoHS compliant

Blue listings indicate standard stock items widely available from our franchised distribution partners.

Detailed specifications for our standard parts can be found quickly on our website at [macomtech.com](http://macomtech.com) by typing the part number into the search box.

All specifications are subject to change.

## Digital Attenuators (continued)

Frequency (MHz)	Part Number	Insertion Loss (dB)	Step Size (dB)	Attenuator Range (dB)	Input IP3 (dBm)	Package
<b>Packaged Products</b>						
20 - 2000	AT-358 ◆	2.7	10	10	35	TO-8-2
<b>400 - 2500</b>	<b>MAATSS00017</b>	<b>1.9</b>	<b>0.5</b>	<b>15.5</b>	<b>46</b>	<b>QSOP-16 (SSOP-16)</b>
<b>500 - 2000</b>	<b>MAATSS0016</b>	<b>2.2</b>	<b>2</b>	<b>30</b>	<b>47</b>	<b>TSSOP-16</b>
500 - 2500	MAATSS0022	1.75	0.5	15.5	46	MSOP-10
<b>500 - 4000</b>	<b>MAATSS0019</b>	<b>1.6</b>	<b>1</b>	<b>15</b>	<b>47</b>	<b>TSSOP-16</b>
<b>500 - 4000</b>	<b>MAADSS0016</b>	<b>1.4</b>	<b>—</b>	<b>31</b>	<b>42</b>	<b>3 mm PQFN-16</b>
<b>2000 - 6000</b>	<b>MAADSS0012</b>	<b>0.75</b>	<b>—</b>	<b>21</b>	<b>42</b>	<b>2 mm PDFN-8</b>
<b>2000 - 6000</b>	<b>MAADSS0018</b>	<b>2.0</b>	<b>—</b>	<b>15.5</b>	<b>42</b>	<b>3 mm PQFN-16</b>
<b>2000 - 6000</b>	<b>MAADSS0019</b>	<b>1.3</b>	<b>—</b>	<b>15</b>	<b>42</b>	<b>3 mm PQFN-16</b>
<b>Attenuators with Drivers</b>						
0 - 2000	AT-106	4.6	1	50	46	CR-13
0 - 2000	AT-107	4	0.5	31.5	48	CR-13
0 - 2000	AT-233	2.8	2	30	50	CR-12
<b>0 - 2000</b>	<b>AT-263</b>	<b>3</b>	<b>1</b>	<b>31</b>	<b>48</b>	<b>CR-12</b>
0 - 2000	AT-273	1.9	16	32	48	CR-11
0 - 2000	AT-283	2.9	0.5	15.5	47	CR-12
<b>0 - 2000</b>	<b>AT20-0106</b>	<b>4.6</b>	<b>1</b>	<b>50</b>	<b>46</b>	<b>CR-13</b>
<b>0 - 2000</b>	<b>AT20-0107</b>	<b>3.8</b>	<b>0.5</b>	<b>31.5</b>	<b>48</b>	<b>CR-13</b>
0 - 2000	AT20-0263	3	1	31	48	CR-12
0 - 2000	AT20-0273	1.9	16	32	48	CR-11
0 - 2000	MAAD-007086-000100	4.7	1	50	48	SOW-24
0 - 2000	MAATCC0005	4.2	0.5	31.5	48	SOW-24
0 - 2000	MAATCC0007	3.2	1	31	48	SOW-16
0 - 2000	MAAD-007084-000100	3	0.5	15.5	48	SOW-16
0 - 2400	MAAD-007082-000100	6	1	50	48	CSP-1
0 - 2400	MAAD-007080-000100	6	1	50	48	CSP-1
0 - 2500	MAATCC0012	2.7	2	30	48	CSP-1
0 - 2500	MAAD-007079-000100	2.7	2	30	48	CSP-1
0 - 3000	MAAD-007085-000100	2.8	1	15	50	SOW-16
0 - 3000	MAATCC0006	3.1	2	30	50	SO-16
0 - 3000	MAATCC0008	1.7	1	15	50	SO-16
0 - 3000	MAATCC0010	4	1	31	48	CSP-1
0 - 3000	MAATCC0012	3.1	2	30	50	SO-16
0 - 3000	MAAD-007078-000100	3.8	1	31	48	CSP-1
0 - 3500	MAAD-007081-000100	3.2	0.5	15.5	48	CSP-1
0 - 3500	MAATCC0014	3.2	0.5	15.5	48	CSP-1
0 - 4000	MAATCC0009	5.1	0.5	31.5	48	CSP-1
0 - 4000	MAADCC0006	2.5	1	15	48	CSP-1
0 - 4000	MAATCC0011	5.1	0.5	31.5	48	CSP-1
0 - 4000	MAAD-007077-000100	2.5	1	15	48	CSP-1
700 - 6000	MAAD-000523	1.6	0.5	31.5	50	4 mm PQFN-24

## CATV Digital Attenuators

Frequency (MHz)	Part Number	Insertion Loss (dB)	Step Size (dB)	Attenuator Range (dB)	Input IP3 (dBm)	Package
50 - 1000	MAAD-008866	1.4	0.5	0 - 31.5	40	4 mm PQFN-24
50 - 1100	MAAD-010305	0.3	15	0 - 15	50	SOT-25

# Diodes



## RF and Microwave Diodes: PIN, Schottky, and Varactor Devices

MACOM produces one of the widest variety of PIN, Schottky, and varactor diodes in the industry for microwave circuit applications from 1 MHz to 80 GHz. Diodes are manufactured in die form, plastic, ceramic, and metal packaging.

- Broadband and high power switch circuits: silicon and GaAs PIN switch diodes
- Analog attenuator circuits: silicon PIN attenuator diodes
- High power limiter circuits: silicon PIN limiter diodes
- Detector and mixer circuits: GaAs and silicon Schottky diodes
- Multiplier circuits: GaAs and silicon Schottky diodes
- Filter and VCO circuits: GaAs and silicon varactor diodes

## Limiter Diodes

- Die series for chip and wire high frequency microwave applications
- Ceramic packaged series for waveguide, coaxial and surface mount applications

## Multiplier Diodes

- Flip chip series for higher frequency millimeter wave applications
- Plastic packaged series for microwave frequency surface mount applications
- Ceramic packaged series for high power waveguide and coaxial applications

## Mixer and Detector Diodes

- Surmount™ chipscale style diodes for surface mount high performance applications
- GaAs flip chip and GaAs beam lead series for surface mount millimeter wave frequency applications
- Plastic series for cost effective, surface mount applications
- Ceramic series for microwave frequency surface mount applications

## Switch and Attenuator PIN Diodes

- CERMACHIP® series for microwave frequency applications
- Plastic series for cost effective, surface mount applications
- \* AlGaAs series for low loss, high isolation millimeter wave frequency applications
- GaAs and silicon flip chip series for surface mount millimeter wave applications
- Surmount chipscale style diodes for surface mount high performance applications
- HIPAX series for high average power surface mount UHF applications
- Kilovolt series for high peak voltage HF and VHF applications
- HIPAX non-magnetic series for high average power MRI HF and VHF applications

## Tuning Diodes

- GaAs constant gamma series for higher frequency and high Q applications
- Plastic packaged silicon varactor diodes for surface mount applications, including VCOs, tunable filters, and phase shifters



## Limiter

Part Number Series	Junction Capacitance (pf)	Max. Peak Power (W) at 1_S P.W. 0.1% Duty	Carrier Lifetime (ns)	Voltage Rating (V)	Input P1dB (dBm)	Package
<b>Die and Packaged Products</b>						
MA4L011 Series	0.13 - 0.24	80	10	15-35	7	Die, Ceramic
MA4L021 Series	0.14 - 0.24	90	10	20-35	8	Die, Ceramic
MA4L022 Series	0.13 - 0.23	90	10	20-35	8	Die, Ceramic
MA4L031 Series	0.14 - 0.21	125	15	30-50	10	Die, Ceramic
MA4L032 Series	0.13 - 0.2	125	15	30-50	11	Die, Ceramic
MA4L062 Series	0.07 - 0.15	200	40	50-75	15	Die, Ceramic
MA4L101 Series	0.15 Max	250	90	100 Min	20	Die, Ceramic
MA4L401 Series	0.3 Max	1000	800	250 Min	30	Die, Ceramic

## Multiplier

Part Number/ Part Number Series	Total Capacitance at Vr=6V (pf)	Min. Breakdown Voltage (Vb)	Carrier Lifetime (ns)	Typical Transition Time (ns)	Package
<b>Plastic Packaged Products</b>					
MA144769, MAVR-044769 Series	0.8 - 1.2	30	50	150	SOT-23
MAVR-044767 Series	3 - 4.5	30	500	600	SOT-23

## Mixing and Detector

Part Number	Junction Capacitance (pf)	Tss (dBm)	Frequency (MHz)	Package
<b>Flip Chip &amp; Beam Lead Products — GaAs</b>				
MA4E1317	0.045	-55	0 - 60000	Flip Chip
MADS-001317-1500	0.045	-55	0 - 60000	Flip Chip with Solder Bumps
MA4E1318	0.045	-55	0 - 60000	Flip Chip
MA4E1319-1	0.045	-55	0 - 60000	Flip Chip
MA4E1319-2	0.045	-55	0 - 60000	Flip Chip
MA4E2160	0.045	-56	1 - 80000	Flip Chip
MA4E2037	0.045	-55	0 - 60000	Beam Lead
MA4E2039	0.045	-55	0 - 60000	Beam Lead
MA4E2040	0.045	-55	0 - 60000	Beam Lead

(continued on page 24)

Note: Part numbers are RoHS compliant

Blue listings indicate standard stock items widely available from our franchised distribution partners.

Detailed specifications for our standard parts can be found quickly on our website at [macomtech.com](http://macomtech.com) by typing the part number into the search box.

All specifications are subject to change.



## Mixing and Detector (continued)

Part Number/ Part Number Series	Junction Capacitance (pf)	Tss (dBm)	Frequency (MHz)	Package
<b>Die and Surface Mount Products — Silicon</b>				
MA4E931Z2-1261A	0.11	-55	0 - 18000	Die
MA4E2054L-1261	0.15	-55	0 - 18000	Die
<b>MA4E2062 Series</b>	<b>0.4</b>	<b>—</b>	<b>0 - 20000</b>	<b>Die</b>
MADS-002545-1307MG	0.11	-53	1 - 18000	Surmount
MA4E2501L-1290	0.12	-53	0 - 26000	Surmount
<b>MA4E2502 Series</b>	<b>0.12</b>	<b>-53</b>	<b>0 - 26000</b>	<b>Surmount</b>
MA4E2513L-1289	0.12	-53	0 - 26000	Surmount
<b>MA4E2514 Series</b>	<b>0.12</b>	<b>-53</b>	<b>0 - 26000</b>	<b>Surmount</b>
<b>MA4E2532 Series</b>	<b>0.11</b>	<b>-53</b>	<b>0 - 26000</b>	<b>Surmount</b>
<b>MA4E2544L-1282</b>	<b>0.15</b>	<b>-53</b>	<b>0 - 26000</b>	<b>Surmount</b>
<b>MA4E2508 Series</b>	<b>0.1</b>	<b>-53</b>	<b>0 - 26000</b>	<b>Surmount</b>

Part Number/ Part Number Series	Junction Capacitance (pf)	Total Max. Capacitance (pf)	Tss (dBm)	Frequency (MHz)
<b>Plastic Packaged Products</b>				
<b>MA4E2200X1*, MADS-002200 Series</b>	<b>0.11</b>	<b>0.25</b>	<b>-55</b>	<b>0 - 4000</b>
<b>MA4E2054X1*, MADS-002054 Series</b>	<b>0.15</b>	<b>0.3</b>	<b>-50</b>	<b>0 - 4000</b>
MADS-003000 Series	0.4	0.5	-50	0 - 3000
MA4E2062, MADS-002062 Series	0.4	0.5	-50	0 - 3000
MA4E2072, MADS-002072 Series	0.5	0.63	-50	0 - 3000
<b>MA4E1338X1*, MADS-001338 Series</b>	<b>0.7</b>	<b>1</b>	<b>-47</b>	<b>0 - 3000</b>
<b>MA4E1340X1*, MADS-001340 Series</b>	<b>0.9</b>	<b>2</b>	<b>-45</b>	<b>0 - 3000</b>
<b>MA4E1339X1*, MADS-001339 Series</b>	<b>1</b>	<b>1.2</b>	<b>-45</b>	<b>0 - 3000</b>

\*Note: The "X" in the above RoHS compliant part numbers varies depending upon the specific part configuration.

Part Number	Junction Capacitance (pf)	Total Max. Capacitance (pf)	Tss (dBm)	Frequency (MHz)
<b>Ceramic Packaged Products</b>				
MA40045-137	0.1	0.3	—	0 - 6000
MA40115-276	0.12	0.32	—	0 - 16000
MA40126-186	0.12	0.32	—	0 - 16000
MA40143-213	0.12	0.32	-50	0 - 10000
MA40147-213	0.12	0.32	-50	0 - 10000
MA40201-119	0.12	0.32	-55	0 - 10000
MA40205-119	0.12	0.32	-55	0 - 10000
MA40215-120	0.12	0.32	-55	0 - 10000
MA40261	0.12	0.32	-55	0 - 10000
MA40264	0.12	0.32	-55	0 - 10000
MA4E914-276	0.14	0.35	—	0 - 18000
MA4E920-276	0.14	0.35	—	0 - 18000
MA4E185-276	0.2	0.4	—	0 - 12000
MA4E190-276	0.2	0.4	—	0 - 12000
MA4E929A-119	0.25	0.45	-55	0 - 18000
MA4E929B-119	0.25	0.45	-55	0 - 18000

Note: Part numbers are RoHS compliant

Blue listings indicate standard stock items widely available from our franchised distribution partners.

Detailed specifications for our standard parts can be found quickly on our website at [macomtech.com](http://macomtech.com) by typing the part number into the search box.

All specifications are subject to change.

## Switch and Attenuator

Part Number/ Part Number Series	Total Capacitance (pF)	Dynamic Resistance (ohms)	Frequency (MHz)	Package
<b>Discrete Diode Products — GaAs</b>				
MA4GP905	0.025	3	100 - 30000	Beam Lead
MA4GP907	0.025	4.2	100 - 30000	Flip Chip
<b>Discrete Diode Products — AlGaAs</b>				
MA4AGP907	0.025	3	100 - 30000	Flip Chip
MADP-000907-14020W	0.025	3	100 - 30000	Flip Chip with Solder Bumps
MA4AGFCP910	0.018	5.2	100 - 40000	Flip Chip
MA4AGBLP912	0.02	4	100 - 40000	Beam Lead
<b>Discrete Diode Products — Silicon</b>				
MA4SPS422	0.18	3.1	1 - 6000	Surmount
MA4SPS421	0.09	6	1 - 10000	Surmount
MA4SPS502	0.14	2.4	10 - 18000	Surmount
MADP-000208-13180W	0.81	0.4	30 - 2000	Surmount
MADP-030015-1314	0.79	0.49	50 - 2000	Surmount
MADP-042505-130600	0.6	0.6	50 - 2000	Surmount
MADP-030025-1314	0.5	0.65	50 - 2000	Surmount
MADP-042408-1305	0.36	0.67	50 - 4000	Surmount
MADP-017015-1314	0.32	0.72	50 - 4000	Surmount
MADP-042405-130600	0.27	0.8	50 - 4000	Surmount
MA4SPS302	0.4	1	50 - 4000	Surmount
MADP-042305-130600	0.14	1.3	50 - 6000	Surmount
MADP-017025-1314	0.23	1	50 - 8000	Surmount
MADP-042508-1305	0.18	0.97	50 - 10000	Surmount
MADP-042308-1305	0.09	1.57	50 - 15000	Surmount
MA4SPS552	0.06	2.5	50 - 15000	Surmount
MADP-042905-130600	0.06	3.1	50 - 16000	Surmount
MADP-042908-1305	0.04	3.63	50 - 18000	Surmount
MA4SPS402	0.04	4.5	50 - 18000	Surmount
MADP-064908-131000	0.05	5	50 - 18000	Surmount
MA4FCP305	0.05	2.1	100 - 18000	Flip Chip
MA4FCP300	0.025	2.6	100 - 30000	Flip Chip
MA4FCP200	0.02	2.8	100 - 40000	Flip Chip
MA4PBL027	0.03	2.8	100 - 18000	Beam Lead
<b>Ceramic Packaged Products — GaAs</b>				
MA4GP030 Series	0.06	2	100 - 18000	Ceramic, Die
MA4GP022 Series	0.15	1.0	100 - 10000	Ceramic, Die
<b>Ceramic Packaged Products — Silicon</b>				
MA4P203 Series	0.15	1.5	30 - 18000	Ceramic, Die
<b>MA4P303 Series</b>	<b>0.15</b>	<b>1.5</b>	<b>20 - 18000</b>	<b>Ceramic, Die</b>
MA4P202 Series	0.25	2.5	50 - 18000	Ceramic, Die
MA4P604 Series	0.3	1	0.5 - 8000	Ceramic, Die
MA4P606 Series	0.6	0.7	0.5 - 1000	Ceramic, Die
MA4P607 Series	1.3	0.4	0.5 - 500	Ceramic, Die

(continued page 26)

Note: Part numbers are RoHS compliant

Blue listings indicate standard stock items widely available from our franchised distribution partners.

Detailed specifications for our standard parts can be found quickly on our website at [macomtech.com](http://macomtech.com) by typing the part number into the search box.

All specifications are subject to change.

Switch and Attenuator (continued)

Part Number/ Part Number Series	Total Capacitance (pF)	Dynamic Resistance (ohms)	Frequency (MHz)	Package
<b>Ceramic Packaged Products – Silicon</b>				
MA4PK2000 Series	2.7	0.2	0.1 - 500	Ceramic, Die
MA4PK3000 Series	3.2	0.15	0.1 - 500	Ceramic, Die
MA4P504 Series	0.20	0.6	1 - 10000	Ceramic, Die, MELF
MA4P404 Series	0.20	0.8	5 - 10000	Ceramic, Die, MELF
MA4P505 Series	0.35	0.45	1 - 6000	Ceramic, Die, MELF
<b>HIPAX/MELF Products</b>				
MA4P1450-1091T	1.4	0.35	1 - 300	MELF
MA4P1250-1072T	0.7	0.5	5 - 500	MELF
MA4P7100 Series	0.7	0.5	1 - 1000	MELF, HIPAX
MA4PH235-1072T	0.8	0.5	50 - 500	MELF
MA4P4000 Series	1.8	0.5	0.1 - 500	MELF, HIPAX
MA4PH237-1072T	1.2	0.6	10 - 300	MELF
MA4P7000 Series	0.4	0.8	1 - 1000	MELF, HIPAX
MA4P4300 Series	1.6	1	0.1 - 500	MELF, HIPAX
MA4PH236-1072T	0.2	3	50 - 1000	MELF
MA4PH238-1072T	0.2	6	10 - 1000	MELF
MA4PH239-1072T	0.5	25	10 - 1000	MELF
MA4P7464F-1072T	0.4	0.5	1 - 500	MELF Non-Magnetic Pkg
MA4P7461F-1072T	0.6	0.5	1 - 500	MELF Non-Magnetic Pkg
MA4P7441F-1091T	1.8	0.5	0.5 - 500	MELF Non-Magnetic Pkg
MA4P7446F-1091T	1.8	0.5	0.5 - 500	MELF Non-Magnetic Pkg
MA4P7470F-1072T	0.4	0.8	0.5 - 1000	MELF Non-Magnetic Pkg
MA4P7452F-1072T	0.4	0.9	0.5 - 1000	MELF Non-Magnetic Pkg

Part Number/ Part Number Series	Total Capacitance (pf)	Dynamic Resistance (ohms)	Frequency (MHz)
<b>Plastic Packaged Products</b>			
MADP-008120-12790T	0.13	2.5	5 - 6000
<b>MA4P7455, MADP-007455 Series</b>	<b>0.15</b>	<b>3</b>	<b>5 - 2500</b>
<b>MA4P7437, MADP-007437 Series</b>	<b>0.15</b>	<b>6</b>	<b>5 - 4000</b>
<b>MA4P7438, MADP-007438 Series</b>	<b>0.15</b>	<b>10</b>	<b>1 - 4000</b>
<b>MA4P7433, MADP-007433 Series</b>	<b>0.2</b>	<b>1.5</b>	<b>25 - 4000</b>
<b>MADP-007167 Series</b>	<b>0.2</b>	<b>16</b>	<b>1 - 4000</b>
<b>MA4P7436, MADP-007436 Series</b>	<b>0.8</b>	<b>0.5</b>	<b>25 - 2500</b>
<b>MA4P7447, MADP-007155 Series</b>	<b>1.0</b>	<b>0.6</b>	<b>15 - 2500</b>

Note: Part numbers are RoHS compliant

Blue listings indicate standard stock items widely available from our franchised distribution partners.

Detailed specifications for our standard parts can be found quickly on our website at [macomtech.com](http://macomtech.com) by typing the part number into the search box.

All specifications are subject to change.

Tuning

Part Number	Total Capacitance at Vr = 4.0V (pF)	Min. Reverse Breakdown Voltage (Vb)	Gamma	Q (Min.) at 50 MHz	Package
<b>Discrete Die Products – GaAs</b>					
MA46H146	0.06	25	1	5000	Flip Chip
MA46H120	0.35	15	1	3000	Flip Chip
MAVR-000120-14110G	0.35	15	1	3000	Flip Chip
<b>Ceramic Packaged Products – GaAs</b>					
MA46600 Series	0.30	30	0.5	8000	
MA46H070 Series	0.6	20	0.75	4500	
MA46H071 Series	1	20	0.75	4500	
MA46H073 Series	5	20	0.75	2200	
MA46461 Series	4.7	22	1.0	1500	
MA46470 Series	0.5	22	1.25	4000	
MA46H200 Series	0.6	22	1.25	3000	
MA46471 Series	0.7	22	1.25	4000	
MA46472 Series	1	22	1.25	3000	
MA46H201 Series	1	22	1.25	3000	
MA46473 Series	1.2	22	1.25	3000	
MA46474 Series	1.5	22	1.25	3000	
MA46477 Series	2.2	22	1.25	3000	
MA46H202 Series	3	22	1.25	2000	
MA46480 Series	3.8	22	1.25	2000	
MA46H203 Series	5	22	1.25	1500	
MA46485 Series	10	22	1.25	1500	
MA46H204 Series	10	22	1.25	1500	
MA46413 Series	1	18	1.5	2500	
MA46H501 Series	1	18	1.5	2500	
MA46416 Series	1.8	18	1.5	2500	
MA46H503 Series	5	18	1.5	1200	
Part Number Series	Total Capacitance at 0.5V (pF)	Min. Breakdown Voltage (Vb)	Q (Min.) Gamma	Q (Min.) at 50 MHz	
<b>Plactic Packaged Products – Silicon</b>					
MAVR-001350 Series	11	12	1	1100	
MAVR-000350 Series	11.8	12	1	400	
MAVR-001340 Series	18	12	1	1050	
MAVR-000340 Series	18.5	12	1	350	
MAVR-001330 Series	25	12	1	900	
MAVR-000320 Series	58	12	1	300	

Note: Part numbers are RoHS compliant

Blue listings indicate standard stock items widely available from our franchised distribution partners.

Detailed specifications for our standard parts can be found quickly on our website at [macomtech.com](http://macomtech.com) by typing the part number into the search box.

All specifications are subject to change.



Tuning (continued)

Part Number Series	Total Capacitance at 2.0V (pF)	Min. Breakdown Voltage (Vb)	Gamma	Q (Min.) at 50 MHz
<b>Plastic Packaged Products</b>				
MAVR-000250 Series	2.7	12	1	450
MA4ST1241, MAVR-001240 Series	3.4	12	1	1200
MA4ST1231, MAVR-001230 Series	4.7	12	1	850

Part Number Series	Total Capacitance at 2.5V (pF)	Min. Breakdown Voltage (Vb)	Gamma	Q (Min.) at 50 MHz
<b>Plastic Packaged Products</b>				
MAVR-000083 Series	5	12	1.3	450
MAVR-000082 Series	7.3	12	1.3	350
MAVR-000079 Series	54.1	12	1.3	80

Part Number Series	Total Capacitance at 4.0V (pF)	Min. Breakdown Voltage (Vb)	Gamma	Q (Min.) at 50 MHz
<b>Plastic Packaged Products</b>				
MAVR-045438 Series	6.8	30	0.5	1600
MAVR-045440 Series	10	30	0.5	1300
MAVR-000401 Series	10	22	1	250
MAVR-000403 Series	15	22	1	250
MAVR-000404 Series	18	22	1	175
MAVR-000405 Series	22	22	1	175
MAVR-045445 Series	27	30	0.5	900
MAVR-045446 Series	33	30	0.5	750
MAVR-000407 Series	33	22	1	150
MAVR-000408 Series	39	22	1	150
MAVR-000409 Series	47	22	1	150

Note: Part numbers are RoHS compliant

Blue listings indicate standard stock items widely available from our franchised distribution partners.

Detailed specifications for our standard parts can be found quickly on our website at [macomtech.com](http://macomtech.com) by typing the part number into the search box.

All specifications are subject to change.



MACOM drivers are used extensively in wireless infrastructure base stations as well as military and defense applications. Drivers are typically used to translate TTL control voltages for attenuators and switches.

- Cordless and mobile phones
- Cellular base stations/wireless infrastructure
- Satellite radio
- GPS and DAB
- 2.4 GHz and 5.0 GHz WLAN
- VSAT
- CATV and broadband
- Bluetooth
- Fixed wireless access (FWA)
- Instrumentation
- Commercial and military radar
- Radar systems
- Test equipment



## Drivers

Part Number	Type	Rise Time/Fall Time (ns)	Vcc (V)	Vee (-V)	Package
<b>Die Products</b>					
MADR-009269-000DIE	Single, PIN or FET	5	5	-10 to -5	Die
MADR-009190-000DIE ◆	Quad, PIN or FET	500	3.3 - 5	-3	Die
<b>Packaged Product</b>					
MADR-010140	TR module	6	3.3 - 5	-5 to -3.3	5 mm PQFN-40
MADR-007097-000100	Single	500	5	-7	SO-8
MADRCC0004	Quad	500	5	-5	SO-16
MADR-007098-000100	PIN	—	5	—	SOW-16
MADRCC0005	Single	500	5	-5	SO-8
MADRCC0006	Single	500	5	-5	SO-8
MADRCC0007	Quad	500	5	-5	SO-16
MADR-009190-000100	Quad, PIN or FET	500	5	-5	SOIC-16
MADR-009443-000100	Quad, PIN or FET	500	5	-5	QFN-20, Tin Plating
MADR-007131-000100	Dual Linearizer	—	5	—	CSP-9
MADR-008851-000100	PIN	420	5	—	LGA-23
MADR-008888-000100	PIN	300	5	—	LGA-23
MADR-010574-000100	PIN	—	5	—	QFN-16
MADR-009269-000100	Single, PIN or FET	5	5	-10 to -5	SOIC-8
LG30 ◆	PIN	2000	15	-15	TO-8, SMT, SM
LG1 ◆	PIN	30000	15	-15	TO-8, SMT, SMA

Note: Part numbers are RoHS compliant ◆ indicates non-RoHS compliant

Blue listings indicate standard stock items widely available from our franchised distribution partners.

Detailed specifications for our standard parts can be found quickly on our website at [macomtech.com](http://macomtech.com) by typing the part number into the search box. All specifications are subject to change.

## Frequency Doublers



MACOM frequency doublers are a specialized class of broadband mixers. They are used in a variety of communications applications.

- Surface mount, connectorized and drop-in packaging available for standard components
- Multi-octave input frequency coverage in the range of 5 MHz–12 GHz high performance applications



## Frequency Doublers

Input Frequency (MHz)	Part Number	VSWR (ratio)	Input Power (dBm)	Output Power (dBm)	Conversion Loss (dB)	Package
<b>Die Products</b>						
7500 - 25000	XX1000-BD	—	0	15	—	Die
18000 - 21000	XX1001-BD	—	0	26	—	Die
<b>Packaged Products</b>						
5 - 2400	FD25 ◆	1.5:1	10	—	11.5	TO-8
5 - 2400	FD25C ◆	1.5:1	10	—	11.5	SMA
5 - 2400	FD25E ◆	1.5:1	10	—	11.5	FP
5 - 2400	FD25H ◆	1.5:1	23	—	12	TO-8
5 - 2400	FD25HC ◆	1.5:1	23	—	12	SMA
<b>5 - 2400</b>	<b>SFD25 ◆</b>	<b>1.5:1</b>	<b>10</b>	<b>—</b>	<b>11.5</b>	<b>SMT</b>
5 - 2400	SFD25H ◆	1.5:1	23	—	12	SMT
5 - 2400	FMS-109 ◆	1.5:1	10	—	11	SMT
10 - 750	FM-105 ◆	2.0:1	13	—	14.5	Relay Header
10 - 2400	CSFD25 ◆	2.0:1	10	—	11.5	SMT
10 - 2400	CSFD25H ◆	2.0:1	23	—	12	SMT
50 - 3300	CSFD26 ◆	2.0:1	10	—	12.5	SMT
50 - 3300	FD26 ◆	2.0:1	10	—	13	TO-8
50 - 3300	FD26C ◆	2.0:1	10	—	13	SMA
50 - 3300	FD26E ◆	2.0:1	10	—	13	FP
50 - 3300	SFD26 ◆	2.0:1	10	—	13	SMT
75 - 1500	FM-104 ◆	2.5:1	13	—	12	FP
200 - 3000	FM-106 ◆	2.0:1	13	—	13	FP
2000 - 9000	FD93 ◆	1.5:1	12	—	12	Hermetic Module
2000 - 9000	FD93C ◆	1.5:1	12	—	12	SMA
2000 - 9000	FD93H ◆	1.5:1	19	—	12	Hermetic Module
2000 - 9000	FD93HC ◆	1.5:1	19	—	12	SMA
2500 - 6000	XX1002-QH	—	-3	16	—	4 mm QFN-24
3000 - 12000	FDZ5013 ◆	2.0:1	13	—	12	Hermetic Module
3000 - 12000	FDZ5013C ◆	2.0:1	13	—	12	SM
8000 - 12000	MAFC-010511	—	-5	17	—	3 mm QFN-28
7500 - 22500	XX1000-QT	—	6	18	—	3 mm QFN-16

Note: Part numbers are RoHS compliant ◆ indicates non-RoHS compliant

Blue listings indicate standard stock items widely available from our franchised distribution partners.

Detailed specifications for our standard parts can be found quickly on our website at [macomtech.com](http://macomtech.com) by typing the part number into the search box.

All specifications are subject to change.

## Limiters



MACOM offers a complete line of RF and microwave limiters, limiting amplifiers and LNA/limiters up to 18 GHz. Our limiters and limiting amplifiers use the latest thin-film hybrid manufacturing techniques to obtain the highest levels of performance, repeatability, reliability and cost-effectiveness. These products use the latest technology available in the industry for silicon and GaAs MMICs, silicon bipolar, and GaAs FET devices.



## Limiting Amplifiers

Frequency (MHz)	Part Number	Gain (dB)	NF (dB)	Output P1dB (dBm)	Max. Limiting (dBm)	VSWR In/Out	Voltage (Volts)	Current (mA)	Package
10 - 500	SMLA88	16.5	6	17	20.5	1.7	15	89	TO-8, SMT, SMA
<b>10 - 1000</b>	<b>LA17</b>	<b>11.5</b>	<b>5.8</b>	<b>10</b>	<b>15</b>	<b>1.7</b>	<b>15</b>	<b>55</b>	<b>TO-8, SMT, SMA</b>
<b>50 - 500</b>	<b>AL7</b>	<b>13</b>	<b>5</b>	<b>-1.5</b>	<b>0.5</b>	<b>1.5</b>	<b>15</b>	<b>54</b>	<b>TO-8, SMT, SMA</b>
<b>50 - 500</b>	<b>LA7</b>	<b>12.5</b>	<b>7</b>	<b>12</b>	<b>15.5</b>	<b>1.5</b>	<b>15</b>	<b>54</b>	<b>TO-8, SMT, SMA</b>
1000 - 4000	LA45	11.5	8	14	15.5	1.7	15	110	TO-8, SMT, SMA
1000 - 4000	LA45-1	14	7.5	17	18.5	1.8	15	110	TO-8, SMT, SMA

## Package Limiters

Frequency (MHz)	Part Number	Insertion Loss (dB)	Avg. Power (W)	Peak Power (W)	Leakage (mW)	Recovery Time (ns)	Package
1000 - 2000	2690-1001 ♦	0.7	1	100	75	100	Coax
1000 - 2000	2690-1003 ♦	0.9	3	1000	100	1000	Coax
50 - 4000	MADL-011008	0.15	1	10	40	50	1.2 x 1.5 mm PDFN-6
2000 - 8000	2690-1005 ♦	1.1	1	100	50	100	Coax
2000 - 8000	2690-1007 ♦	1.3	3	1000	100	1000	Coax
2000 - 18000	2690-1013 ♦	2	1	100	50	100	Coax
2000 - 18000	2690-1014 ♦	2.2	2	500	75	250	Coax
2000 - 18000	2690-1015 ♦	2.3	3	1000	100	1000	Coax
8000 - 18000	2690-1009 ♦	1.8	1	100	50	100	Coax
8000 - 18000	2690-1011 ♦	2.3	3	1000	100	1000	Coax

## Signal Limiters

Frequency (MHz)	Part Number	Insertion Loss (dB)	Limiting Level (dB)	Input VSWR	Output VSWR	Voltage (Volts)	Current (mA)	Package
<b>5 - 3000</b>	<b>L1</b>	<b>3</b>	<b>4</b>	<b>1.7</b>	<b>1.9</b>	<b>+15</b>	<b>7</b>	<b>TO-8, SMT, SMA</b>
50 - 4000	L42	4	4.5	1.7	2	+15	7	TO-8, SMT, SMA

Note: Part numbers are RoHS compliant ♦ indicates non-RoHS compliant

Blue listings indicate standard stock items widely available from our franchised distribution partners.

Detailed specifications for our standard parts can be found quickly on our website at [macomtech.com](http://macomtech.com) by typing the part number into the search box.

All specifications are subject to change.



## Modulators and Mixers



MACOM modulators and mixers are widely used in aerospace and defense, wireless and broadband communications applications. We offer a variety of connectorized, flat pack, drop-in and surface mount packages with a broad range of operating frequency ranges and performance specifications for these markets.

### Modulators

- Products available in subsets of the 9 – 960 MHz frequency range
- Surface mount packaging for maximum performance

### Mixers

- Double and triple balanced designs
- Variety of technologies
  - Hybrid assemblies using Schottky quad diodes
  - GaAs pHEMT
  - Si HMIC
- Products available in subsets of the frequency range
  - RF/LO: 50 KHz – 24 GHz
  - IF: DC – 8 GHz



## Demodulators

Frequency Fmin (MHz)	Fmax (MHz)	Part Number	Conversion Loss (dB)	Amplitude Unbalance (dB)	Phase Unbalance (deg)	Harmonic 3X I/Q (dBc)	Package
70	90	MAAD-007251 ♦	—	—	—	—	6 mm PFQN

## Receivers

Frequency (MHz)	Part Number	Conversion Gain (dB)	Noise Figure (dBm)	Image Rejection (dBm)	LO Input Power (dBm)	Package
<b>Die Products</b>						
4500 - 10500	XR1011-BD	14	1.6	20	5	Die
30000 - 46000	XR1004-BD	9	3.5	18	2	Die
<b>Packaged Products</b>						
45000 - 10500	XR1011-QH	13	1.8	20	5	4 mm QFN-24
10000 - 16000	XR1015-QH	12	2.5	20	5	4 mm QFN-24
27500 - 33400	XR1019-QH	13	2.5	20	4	4 mm QFN-24
37000 - 40000	XR1008-QB	9	3.5	18	2	7 mm SMT

## Up/Down Converters

Frequency (MHz)	Part Number	Description	Conversion Gain (dB)	LO Input (dBm)	Output P1dB (dBm)	Output IP3 (dBm)	Package
<b>Die Products</b>							
18000 - 36000	XU1009-BD	Up converter	9	2	16	25	Die
35000 - 45000	XU1004-BD	Up converter	5	4	6	14	Die
<b>Packaged Products</b>							
17000 - 34000	XU1010-QH	Up converter	-10	2	5	15	4 mm QFN-24
37000 - 40000	XU1019-QH	Up converter	7	3	—	27	4 mm QFN-24
40500 - 43500	MAUC-010515	Up converter	11	0	—	30	6 mm laminate

Note: Part numbers are RoHS compliant ♦ indicates non-RoHS compliant

Blue listings indicate standard stock items widely available from our franchised distribution partners.

Detailed specifications for our standard parts can be found quickly on our website at [macomtech.com](http://macomtech.com) by typing the part number into the search box.

All specifications are subject to change.

## Mixers

Frequency (RF/LO) (MHz)	Frequency (IF) (MHz)	Part Number	LO Drive (dBm)	Conversion Loss (dB)	Isol. (LO/RF) (dB)	Input P1dB (dBm)	Package
<b>Die Products</b>							
8000 - 42000	DC - 4000	XM1001-BD	—	8	—	—	Die
15000 - 42000	DC - 4000	XM1003-BD	—	9	—	—	Die
30000 - 50000	DC - 4000	XM1002-BD	—	8	—	—	Die
<b>Packaged Products</b>							
DC - 960	820 - 915	MAMXES0072	7	7	40	5	SM-89
0.05 - 200	0 - 200	M6D-50 ◆	7	7	50	0	RH
0.05 - 200	0 - 200	SM6D ◆	7	7	45	—	SMT
0.2 - 200	0 - 200	MAC-50 ◆	7	6	25	1	TO-52
0.2 - 200	0.2 - 200	MDS-222 ◆	7	7.5	35	2	SF-1
0.4 - 500	0 - 500	M6V, SM6V ◆	7	6.5	47	0	TO-5, SMT
<b>0.5 - 500</b>	<b>0 - 500</b>	<b>ELCM-1</b>	<b>7</b>	<b>6.2</b>	<b>27</b>	<b>1</b>	<b>SM-89</b>
0.5 - 500	0 - 500	ELCM-1H	17	7.2	35	14	SM-87
0.5 - 500	0 - 500	EMRS-1	7	6.2	27	1	SM-1
0.5 - 500	0 - 500	M9BC ◆	17	7	52	8	RH
0.5 - 500	0 - 500	MAMXES0022	7	6.5	30	1	SM-134
0.5 - 500	0 - 500	MD-124 ◆	7	7	25	2	FP-2
0.5 - 500	0.5 - 500	MAMXES0108	5	6.5	50	1	SM-89
1 - 400	0 - 400	M9E ◆	27	7	40	20	RH
1 - 500	0 - 500	MD-161 ◆	13	8	25	10	FP-2
1 - 1000	0 - 1000	ESMD-C1	7	7.5	45	1	SM-2
1 - 1000	1 - 1000	MAMXES0028 ◆	7	7.5	30	1	SM-134
1 - 1500	1 - 1000	MD-160 ◆	13	9	25	—	RH-3
1 - 3400	1 - 2000	CSM4T	10	8	35	7	SMT
1 - 3400	1 - 2000	CSM4T17	17	8	35	14	SMT
<b>1 - 3400</b>	<b>1 - 2000</b>	<b>M4T ◆, SM4T</b>	<b>10</b>	<b>8</b>	<b>35</b>	<b>6</b>	<b>FP, SMT</b>
<b>1 - 3400</b>	<b>1 - 2000</b>	<b>M4TH, SM4TH ◆</b>	<b>23</b>	<b>8</b>	<b>35</b>	<b>17</b>	<b>FP, SMT</b>
<b>1 - 3400</b>	<b>1 - 2000</b>	<b>M8T, M8TC ◆</b>	<b>10</b>	<b>7</b>	<b>38</b>	<b>7</b>	<b>TO-8, SMA</b>
1 - 3400	1 - 2000	M8TH, M8THC ◆	23	7.5	36	17	TO-8, SMA
<b>1 - 3400</b>	<b>1 - 2000</b>	<b>SM4T17</b>	<b>17</b>	<b>8</b>	<b>35</b>	<b>13</b>	<b>SMT</b>
1 - 3500	1 - 3500	MD-189 ◆	23	8	35	20	FP-2
1 - 3500	1 - 3500	MDC-169 ◆	10	10	35	7	C-7
<b>1 - 3500</b>	<b>1 - 3500</b>	<b>MD-169 ◆</b>	<b>10</b>	<b>10</b>	<b>35</b>	<b>7</b>	<b>FP-2</b>
1 - 3500	5 - 1500	MDS-169v	10	8	35	7	SF-1
1 - 3500	1 - 3500	MDS-189 ◆	23	8	35	20	SF-1
1 - 4000	5 - 1500	MD-179 ◆	7	10.5	35	5	FP-2
1 - 4000	5 - 1500	MDC-179 ◆	7	10.5	35	5	C-7
2 - 500	0 - 500	ELCM-1MH	13	6	30	9	SM-89
2 - 2200	2 - 2200	MAMX-009646-230BML	17-23	6	47	23	SM-194
5 - 500	0 - 500	M6E-50v	7	7.5	43	—	RH
5 - 500	0 - 500	MAC-51 ◆	7	7	25	2	TO-5-2
5 - 500	0 - 500	MD-108 ◆	7	9	35	2.5	RH-3
5 - 750	0 - 500	SM6EH ◆	20	6	45	13	SMT
5 - 750	0 - 500	M6EHv	20	6	47	13	RH
5 - 1000	0 - 1000	ELCM-2	7	7	25	1	SM-89
5 - 1000	0 - 1000	MAMXES0115	7	7	25	1	SM-89
5 - 1000	0 - 1000	MD-113 ◆	7	8	25	0	FP
5 - 1000	0 - 1000	EMRS-2	7	7	25	1	SM-1

Note: Part numbers are RoHS compliant ◆ indicates non-RoHS compliant

Blue listings indicate standard stock items widely available from our franchised distribution partners.

Detailed specifications for our standard parts can be found quickly on our website at [macomtech.com](http://macomtech.com) by typing the part number into the search box.

All specifications are subject to change.

## Mixers (continued)

Frequency (RF/LO) (MHz)	Frequency (IF) (MHz)	Part Number	LO Drive (dBm)	Conversion Loss (dB)	Isol. (LO/RF) (dB)	Input P1dB (dBm)	Package
5 - 1500	0 - 1000	ELCM-5	7	7.5	30	1	SM-87
5 - 1500	0 - 1000	EMRS-5MH	13	9	30	7.5	SM-1
5 - 1500	0 - 1000	MD-158 ♦	7	9	20	1	FP
5 - 1900	5 - 1000	ELCM-11X	7	7.4	27	1	SM-87
5 - 1900	5 - 1000	MAMXES0041 ♦	7	7.4	30	1	SM-134
5 - 2500	5 - 1500	MAMX-007238-CM25MH	13	6.5	36	30	SM-87
10 - 500	10 - 500	MDS-223 ♦	7	7	40	2.5	SF-1
10 - 1000	0 - 600	M2E, SM2E, M2EC ♦	20	8	33	—	TO-8, SMT, S
10 - 1200	0 - 1000	M6R ♦	7	8	40	0	TO-5
<b>10 - 1500</b>	<b>0 - 800</b>	<b>M2A, M2AC ♦</b>	<b>7</b>	<b>7.5</b>	<b>40</b>	<b>0</b>	<b>TO-8, SMA</b>
10 - 1500	0 - 1000	M4A, SM4A ♦	7	7.5	35	0	FP, SMT
10 - 1500	0 - 1000	M4B, SM4B ♦	13	7.5	35	7	FP, SMT
10 - 1500	0 - 600	M9H, M9HC ♦	20	8	29	15	TO-8, SMA
10 - 1500	10 - 1500	MD-148 ♦	10	6	40	5	FP
10 - 1500	10 - 1500	MD-149 ♦	7	7.5	40	0	FP
10 - 1500	10 - 1500	MDS-148 ♦	10	6	40	5	SMT
10 - 1500	10 - 1500	MDS-149 ♦	7	7.5	40	0	SMT
10 - 1600	0 - 800	M2B, M2BC ♦	13	7.5	43	7	TO-8, SMA
<b>10 - 2000</b>	<b>10 - 800</b>	<b>ESMD-C15</b>	<b>10</b>	<b>6.5</b>	<b>30</b>	<b>5</b>	<b>SM-2</b>
10 - 2400	1 - 1000	M2T, M2TC ♦	13	8	40	11	TO-8, SMA
10 - 2500	10 - 2500	MAMX-009239-001500	17	7.6	35	13	SM-87
50 - 4800	50 - 3000	CSM5T ♦	10	7.2	35	7	SMT
50 - 4800	50 - 3000	CSM5T17 ♦	17	7.8	33	14	SMT
50 - 4800	50 - 3000	CSM5TH ♦	23	7	35	17	SMT
50 - 5000	50 - 3000	M5T ♦	10	8	32	7	FP
<b>50 - 5000</b>	<b>50 - 3000</b>	<b>SM5T ♦</b>	<b>10</b>	<b>7.5</b>	<b>32</b>	<b>7</b>	<b>SMT</b>
50 - 5000	50 - 3000	SM5T17 ♦	17	7.5	32	13	SMT
50 - 5000	50 - 3000	SM5TH ♦	23	7.7	32	17	SMT
<b>80 - 2500</b>	<b>0 - 1000</b>	<b>ESMD-C50H</b>	<b>17</b>	<b>7.3</b>	<b>28.9</b>	<b>14</b>	<b>SM-2</b>
80 - 2500	0 - 1000	MAMXES0117	17	7.3	29	14	SM-2
<b>80 - 2500</b>	<b>0 - 1000</b>	<b>ESMD-C50L</b>	<b>10</b>	<b>7.7</b>	<b>30</b>	<b>5</b>	<b>SM-2</b>
<b>80 - 2500</b>	<b>0 - 1000</b>	<b>ESMD-C50M</b>	<b>13</b>	<b>7.4</b>	<b>29.1</b>	<b>8</b>	<b>SM-2</b>
100 - 1100	100 - 1100	MAMX-010458-000001	15-22	6	40	17	SM-87
234 - 245	10 - 20	MAMX-007242-ES0103	17-21	6	36	22	SM-2
<b>300 - 5000</b>	<b>0.1 - 3000</b>	<b>MD-154 ♦</b>	<b>10</b>	<b>10</b>	<b>11</b>	<b>7</b>	<b>FP</b>
350 - 2000	0 - 400	EMRS-11F	7	6.8	25	1	SM-1
500 - 9000	10 - 2000	MDC-164 ♦	13	6.5	17	8	SMA
500 - 19000	30 - 5000	M87, M87C ♦	13	9	24	8	Minpac, SMA
600 - 3000	0 - 1000	MD-156 ♦	7	9	20	0	FP
700 - 1000	10 - 150	MD22-0002-MUC	5	—	22	8	SM-41
700 - 1400	0 - 400	MAMX-000900-1061LT	7	7	37	14	SOIC-8
700 - 1400	0 - 400	EMD40-900L	17	9	28	2.5	SOIC-8
700 - 2000	0 - 300	MD-614 ♦	7	8	25	0	FP
800 - 1000	1 - 150	CSM11-13 ♦	13	7.5	35	9	SMT
<b>800 - 1000</b>	<b>0 - 100</b>	<b>MD54-0004 ♦</b>	<b>13</b>	<b>7.5</b>	<b>38</b>	<b>21</b>	<b>SOIC-8</b>
<b>800 - 1000</b>	<b>0 - 100</b>	<b>MAMXSS0011</b>	<b>13</b>	<b>7.5</b>	<b>38</b>	<b>21</b>	<b>SOIC-8</b>

(continued on page 38)

Note: Part numbers are RoHS compliant ♦ indicates non-RoHS compliant

Blue listings indicate standard stock items widely available from our franchised distribution partners.

Detailed specifications for our standard parts can be found quickly on our website at [macomtech.com](http://macomtech.com) by typing the part number into the search box.

All specifications are subject to change.

## Mixers (continued)

Frequency (RF/LO) (MHz)	Frequency (IF) (MHz)	Part Number	LO Drive (dBm)	Conversion Loss (dB)	Isol. (LO/RF) (dB)	Input P1dB (dBm)	Package
<b>800 - 1000</b>	<b>0 - 200</b>	<b>MD54-0005</b> ◆	<b>5</b>	<b>8</b>	<b>35</b>	<b>15</b>	<b>SOT-25</b>
<b>800 - 1000</b>	<b>0 - 200</b>	<b>MAMXSS0012</b>	<b>5</b>	<b>8</b>	<b>35</b>	<b>15</b>	<b>SOT-25</b>
<b>800 - 1000</b>	<b>170</b>	<b>MD57-0001</b> ◆	<b>-5</b>	<b>9.3</b>	<b>28</b>	<b>14</b>	<b>SOT-26</b>
<b>800 - 1000</b>	<b>170</b>	<b>MAMX-008611</b>	<b>-5</b>	<b>9.3</b>	<b>28</b>	<b>14</b>	<b>SOT-26</b>
800 - 2400	0 - 1500	M4G, SM4G ◆	7	7.5	32	0	FP, SMT
850 - 1050	0 - 200	MA4EXP950H-1277T ◆	15	8.3	55	12.7	MLP 3 mm
850 - 1050	0 - 400	MA4EXP950L-1277T ◆	5	8.5	62	4.3	MLP 3 mm
850 - 1050	0 - 400	MA4EXP950M-1277T ◆	10	8.2	62	8.1	MLP 3 mm
880 - 915	150 - 170	MAMX-008786-ES0120	17	5.5	30	17	SM-1
925 - 1880	45 - 95	MAMX-008782-ES0118	7	9.5	35	7	SM-1
1000 - 6000	10 - 2000	MDC-163 ◆	0	7	10	-2	SMA
1000 - 7000	10 - 2000	MDC-162 ◆	13	6	15	8	SMA
1000 - 18000	0 - 500	DM1-18A ◆	7	6	22	3	SMA
1000 - 18000	30 - 5000	M83, M83C ◆	13	7.5	25	6	Minpac, SMA
1000 - 18000	1000 - 8000	M88, M88C ◆	13	8	28	7	Minpac, SMA
1000 - 18000	1000 - 8000	M89, M89C ◆	10	8	28	4	Minpac, SMA
1400 - 2100	0 - 500	MD54-0006 ◆	5	8	28	12	SOT-25
1400 - 2100	0 - 500	MAMXSS0013	5	8	28	12	SOT-25
<b>1700 - 2000</b>	<b>0 - 200</b>	<b>MD54-0003</b> ◆	<b>13</b>	<b>8.5</b>	<b>27</b>	<b>21</b>	<b>SOIC-8</b>
<b>1700 - 2000</b>	<b>0 - 200</b>	<b>MAMXSS0010</b>	<b>13</b>	<b>8</b>	<b>28</b>	<b>21</b>	<b>SOIC-8</b>
1700 - 2200	100 - 400	MD57-0002 ◆	0	8.5	18	15	SOT-26
1700 - 2200	0 - 400	MA4EXPI90H-1277T ◆	15	8.4	48	11.3	MLP 3 mm
1700 - 2300	0 - 500	MA4EXI90H-1225T ◆	15	6.6	30	10.5	SOT-25
1700 - 2500	0 - 500	MAMX-000240-1225MT	10	5.5	17	5.3	SOT-25
1800 - 2000	10 - 150	CSM12-13 ◆	13	6.7	30	8	SMT
1800 - 10000	0 - 1000	MY84, MY84C ◆	9	6.5	39	4	Versapac, SMA
1900 - 2200	160 - 390	CSM2-17	17	8	40	14	SMT
2000 - 10000	0 - 2000	MC4110 ◆	10	6.2	22	3	Open Carrier
2000 - 18000	30 - 5000	MY82, MY82C ◆	13	7.5	20	6	Versapac, SMA
2000 - 18000	0 - 1000	MY85, MY85C ◆	7	8	35	1	Versapac, SMA
2000 - 18000	1000 - 8000	MY88, MY88C ◆	13	8	28	7	Versapac, SMA
2000 - 18000	1000 - 8000	MY89, MY89C ◆	10	8	28	4	Versapac, SMA
2000 - 18000	30 - 4000	MY93, MY93C ◆	10	8	29	4	Versapac, SMA
2000 - 18000	2000 - 18000	M50A, M50AC ◆	10	8	26	5	Minpac, SMA
2000 - 18000	0 - 1000	M85, M85C ◆	7	8	35	1	Minpac, SMA
2000 - 18000	2000 - 8000	M88H, M88HC ◆	21	8	28	17	Minpac, SMA
2000 - 18000	30 - 4000	M93, M93C ◆	10	8	29	4	Minpac, SMA
2000 - 18000	1000 - 8000	MZ8810, MZ8810C ◆	10	7.5	25	6	Versapac, SMA
2000 - 18000	1000 - 8000	MZ8813, MZ8813C ◆	13	7	25	8	Versapac, SMA
2000 - 18000	30 - 5000	MZ9310, MZ9310C ◆	10	7.5	23	6	Versapac, SMA
2000 - 18000	30 - 5000	MZ9313, MZ9313C ◆	13	7	24	8	Versapac, SMA

Note: Part numbers are RoHS compliant ◆ indicates non-RoHS compliant

Blue listings indicate standard stock items widely available from our franchised distribution partners.

Detailed specifications for our standard parts can be found quickly on our website at [macomtech.com](http://macomtech.com) by typing the part number into the search box.

All specifications are subject to change.

## Mixers (continued)

Frequency (RF/LO) (MHz)	Frequency (IF) (MHz)	Part Number	LO Drive (dBm)	Conversion Loss (dB)	Isol. (LO/RF) (dB)	Input P1dB (dBm)	Package
2000 - 24000	100 - 5000	MZ5210, MZ5210C ◆	10	9	20	4	Versapac, SMA
2000 - 24000	1000 - 15000	M51, M51C ◆	10	8	25	5	Minpac, SMA
2000 - 24000	100 - 5000	M52, M52C ◆	10	8	22	5	Minpac, SMA
2000 - 24000	1000 - 15000	MY51, MY51C ◆	10	8	25	5	Versapac, SMA
2000 - 24000	100 - 5000	MY52, MY52C ◆	10	8	22	5	Versapac, SMA
2000 - 26000	100 - 6000	M53, M53C ◆	10	8	22	5	Minpac, SMA
<b>2000 - 26000</b>	<b>1000 - 15000</b>	<b>M50, M50C ◆</b>	<b>10</b>	<b>8</b>	<b>26</b>	<b>5</b>	<b>Minpac, SMA</b>
2000 - 26000	1000 - 15000	MY50, MY50C ◆	10	8	26	5	Versapac, SMA
2000 - 26000	1000 - 12000	MY50A, MY50AC ◆	10	8	26	5	Versapac, SMA
2100 - 2700	0 - 300	MD54-0007 ◆	13	8	25	18	SOT-25
2110 - 2170	134 - 246	MAMXES0050 ◆	7	10	22	1	SM-87
2300 - 2800	0 - 200	MA4EXP240L-1277T ◆	5	8.3	51	4.8	MLP 3 mm sq.
2400 - 6000	0 - 2000	M8H-7, M8HC-7 ◆	7	6	40	0	TO-8, SMA
2500 - 5500	0 - 1500	M63, M63C ◆	9	5.5	40	2	Minpac, SMA
2500 - 6500	0 - 1500	M63H, M63HC ◆	20	6	37	14	Minpac, SMA
2500 - 6500	0 - 1500	MY63H, MY63HC ◆	20	7.5	26	14	Versapac, SMA
3500 - 18000	0 - 3000	M86, M86C ◆	7	7	34	3	Minpac, SMA
3700 - 4200	0 - 2000	M8H-3, M8HC-3 ◆	7	5	40	0	TO-8, SMA
4000 - 18000	0 - 3000	M80, M80C ◆	7	6.5	34	3	Minpac, SMA
4000 - 20000	0 - 4000	MC4520 ◆	20	7	30	11	Open Carrier
4500 - 9500	0 - 2000	M76, M76C ◆	10	6	35	3	Minpac, SMA
4500 - 9500	0 - 2000	M76H, M76HC ◆	20	7	35	15	Minpac, SMA
4500 - 9500	0 - 2000	MY76, MY76C ◆	10	6	35	3	Versapac, SMA
4500 - 9500	0 - 2000	MY76H, MY76HC ◆	20	7	35	15	Versapac, SMA
5000 - 18000	0 - 3000	M79, M79C ◆	10	7	32	4	Minpac, SMA
5000 - 18000	0 - 3000	M79H, M79HC ◆	20	7.5	33	15	Minpac, SMA
6000 - 14000	0 - 2000	M14A ◆	7	6.5	32	2	SMA
6000 - 18000	0 - 3000	MZ7407, MZ7407C ◆	7	6.5	34	3	Versapac, SMA
6000 - 18000	0 - 3000	MZ7410, MZ7410C ◆	10	6.5	34	4	Versapac, SMA
6000 - 18000	0 - 3000	MZ7420, MZ7420C ◆	20	7.5	33	15	Versapac, SMA
7000 - 18000	0 - 3000	M74, M74C ◆	10	6.5	35	4	Minpac, SMA
8000 - 12500	0 - 2500	M77, M77C ◆	10	5.5	35	4	Minpac, SMA
<b>8000 - 12500</b>	<b>0 - 2500</b>	<b>MY77, MY77C ◆</b>	<b>10</b>	<b>5.5</b>	<b>35</b>	<b>4</b>	<b>Versapac, SMA</b>
8000 - 36000	DC - 4000	XM1001-QH	—	9	—	—	4 mm
9000 - 15000	0 - 2500	M67, M67C ◆	10	6.5	35	4	Minpac, SMA

Note: Part numbers are RoHS compliant ◆ indicates non-RoHS compliant

Blue listings indicate standard stock items widely available from our franchised distribution partners.

Detailed specifications for our standard parts can be found quickly on our website at [macomtech.com](http://macomtech.com) by typing the part number into the search box.

All specifications are subject to change.





## MACOM Modulator Driver Amplifiers

The modulator driver amplifier line includes Electro-absorption (EA) modulator drivers for low cost, short range, datacom applications, as well as high voltage Mach Zehnder (MZ) drivers for metro and long haul telecoms systems.

Some key features of the modulator drivers include:

- Range of single- and multi-channel drivers
- Single-ended or differential interface drivers for improved performance
- Surface mount and GPPO-based packages
- Single-channel and ultra low power quad-channel driver solutions for CFP/CFP2

## MACOM Transimpedance Amplifiers (TIA)

Our optoelectronics product line also includes a wide range of transimpedance amplifiers (TIA) for 40G and 100G fiber optic receivers. The family includes linear TIAs for coherent receivers and limiting TIAs for non-coherent receivers. These parts feature market leading gain and power dissipation. They are available in die form for integration with photo-detectors in an optical sub-assembly.

The key features of the MACOM TIA family are:

- Single- and dual-channel transimpedance amplifiers
- Linear and limiting TIAs for line and client side 40G and 100G systems
- High transimpedance gain — up to 6 k $\Omega$
- Low power dissipation — <0.4 W
- Optional closed loop gain control
- Integrated DC offset cancellation



### Modulator Driver Amplifiers

Part Number	Description	Application	Data Rate Max (Gbps)	Voltage Max Output (Vpp)	Rise/Fall Times (ps)	Power Dissipation (W)	Input Interface	Output Interface	Package Size (mm)
MAOM-002103	40-100 Gbps MZ Driver	100G DP-QPSK/40G DQPSK	32	8	12	0.94 - 2.34	Single-Ended	Single-Ended	14.4 x 7
MAOM-002105	22.3G/32 Gbps MZ Driver	100G DP-QPSK/40G	32	8	12	0.94 - 2.34	Single-Ended	Single-Ended	14.4 x 7
MAOM-003104	Quad Channel 32Gbps MZ Driver	100G DP-QPSK	32	8	11	9.5	Single-Ended	Single-Ended	25x40x6.5
MAOM-003105	Quad Channel 32Gbps MZ Driver	100G DP-QPSK	32	8	12	7.5	Single-Ended	Single-Ended	24.5 x 34.6
MAOM-003106	Dual Channel 32 Gbps MZ Driver	100G DP-QPSK	32	8	12	2.6	Differential	Single-Ended	10 x 10
MAOM-002200	28 Gbps EML Driver	100GbE, CFP	28	2.5	12	1.15	Differential	Single-Ended	4 x 4
MAOM-002201	28 Gbps EML Driver	100GbE, CFP	28	2.5	12	1.15	Differential	Single-Ended	Die
MAOM-002204	Quad Channel 28 Gbps EML Driver	100GbE, CFP	28	2.5	12	2.8	Differential	Single-Ended	14 x 8
MAOM-002108	28 Gbps MZ Driver	100G ODB/40G DQPSK	28	6.5	11	1.3	Differential	Differential	4.7 x 6.5
MAOM-002203	28 Gbps EML Driver	100 Gbps CFP	28	2.5	12	0.75	Differential	Single-Ended	4 x 4
MAOM-002207	28 Gbps EML Driver	100 Gbps CFE	28	2.5	12	0.75	Differential	Single-Ended	Die
MAOM-004201	44.6 Gbps EML Driver	40G XLMD/VSR TOSA	44.6	2.5	8.5	1.5	Differential	Single-Ended	Die
MAOM-011005	Dual Channel 10 Gbps MZ Driver	40G DP-QPSK	12.5	8	25	2	Single-Ended	Single-Ended	8 x 8
MAOM-002100	22.3 Gbps MZ Driver	40G DQPSK	22.3	8	13	1.8	Differential	Differential	4.7 x 6.5
MAOM-010567	10 Gbps MZ Driver	40G DP-QPSK/10G NRZ	12.5	8	25	1	Single-Ended	Single-Ended	11.4 x 8.9
MAOM-001200	11.3 Gbps EML Driver	10G SONET, 10GbE	11.3	3	27	0.65	Differential	Differential	4 x 4
MAOM-001201	11.3 Gbps EML Driver	10G SONET, 10GbE	11.3	2.5	28	0.45	Differential	Differential	3 x 3
MAOM-001600	16 Gbps MZ Driver	10G RZ	16	6.5	16	1.3	Differential	Differential	4 x 4

### Transimpedance Amplifiers

Part Number	Description	Application	Data Rate Max (Gbps)	Max Input Current (mA)	Trans Gain Max (ohms)	Small Signal Bandwidth (GHz)	Power Dissipation (W)	Input Interface	Output Interface	Package Size (mm)
MATA-002900	28 Gbps Limiting TIA	100G Ethernet ROSA	28	3	6000	26	0.3	Single-Ended	Differential	Die
MATA-002902	Dual Channel 32 Gbps Limiting TIA for 100GbE ROSA	100G Ethernet ROSA	28	2	6000	20	0.3	Single-Ended	Differential	Die
MATA-003800	32 Gbps Linear TIA	100G DP-QPSK-RX	32	2	2300	26	0.3	Differential	Differential	Die
MATA-03802A	Dual Channel 32G Linear TIA	100G DP-QPSK-RX	32G	2	5000	25	0.7	Differential	Differential	Die
MATA-003803	Dual Channel 32G Linear TIA	100G DP-QPSK-RX	32G	4	5000	25	0.7	Differential	Differential	Die
MATA-002800	22.3 Gbps Linear TIA	40G DQPSK-RX	22.3	2.5	4500	24	0.3	Differential	Differential	Die
MATA-02802A	Dual Channel 22.3G Linear TIA	40G DQPSK-RX	22.3	2.1	4500	15	0.6	Differential	Differential	Die
MATA-01802A	Dual Channel 10G Linear TIA	40G DP-QPSK-RX	13	2	5000	12	0.55	Differential	Differential	Die

### Limiting Amplifiers

Part Number	Description	Application	Data Rate Max (Gbps)	Input Voltage (mVpp)	Output Voltage (mVpp)	Rise/Fall Times (ps)	Power Dissipation (W)	Input Interface	Output Interface	Package Size (mm)
MAAR-002801	22 Gbps Limiting Amplifier	40G DQPSK	22.3	50-800	600	10	0.40	Differential	Differential	3 x 3

Note: All part numbers shown in the tables above are RoHS compliant.

Detailed specifications for our standard parts can be found on our website at [macomtech.com](http://macomtech.com) by typing the part number into the search box. All specifications are subject to change.

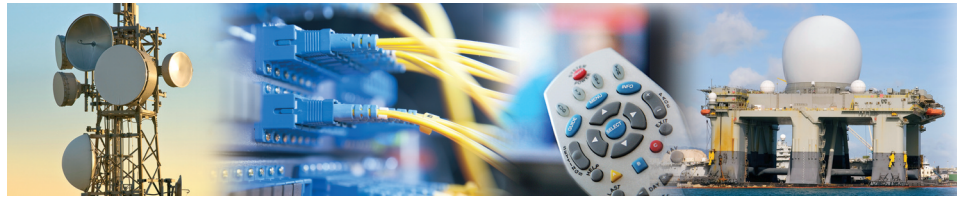

## Transformers

MACOM offers many standard transformers used for a variety of wireless, wireline, and aerospace and defense (A&D) communications applications.

- Available in a variety of surface mount, flat pack and connectorized packages
- Standard impedance ratios up to 4:1
- Balanced/unbalanced versions available
- 50 ohm and 75 ohm nominal impedance devices available

## MNS Microwave Chip Capacitors

- Suitable for DC blocking and RF bias networks in a variety of control and filter circuits
- Capacitance-temperature coefficient provides <200 ppm/C
- Insertion loss <0.1 dB at 15 GHz
- Ideal for chip and wire/ribbon microwave high performance circuits

## Inductors

We offer a line of high Q toroidal inductors useful for any application requiring RF or electromagnetic suppression.

- Standard devices are in the 53 to 273 nH inductance range
- Q of 90 minimum
- Surface mount wire wound toroid construction

## Splitters/Combiners

Splitters and combiners are used in a wide range of A&D, wireless, and wireline communications applications. We offer a variety of connectorized and surface mount packages for these markets.

- 50 ohm and 75 ohm devices
- Products available in subsets of 400 kHz to 26 GHz frequency range
- 2, 3, 4, 5, 6, and 8 channel versions available

## Couplers

Couplers are used extensively in a wide range of A&D, wireless, and wireline communications applications. We offer a variety of connectorized and surface mount devices with a broad range of coupling values for these markets.

### Hybrid Couplers

- Magic Tee (1800) and Quadrature (900) configurations
- Products available in subsets of the 2-3000 MHz frequency range
- Available as TO-cans, flatpacks, surface mount, and connectorized

### Directional Couplers

- Coupling values of 6 dB to 30 dB
- Products available in subsets of the 2 MHz to 18 GHz frequency range
- 75 ohm products available for CATV, DTV, and DBS applications

### Filters/Diplexers

MACOM offers a variety of highpass, lowpass, and diplex filter components and assemblies used in common wireless communications standards and CATV, DBS, and DTV applications.

- 50 ohm and 75 ohm diplexers
- Low cost surface mount packaging
- Multi-chip and MMIC products
- Higher functionality assemblies available

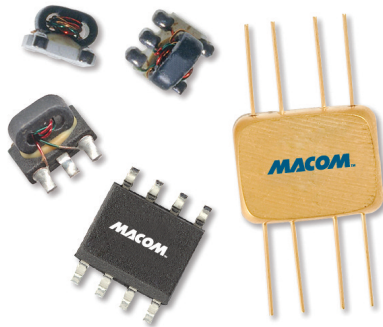

Transformers

Frequency (MHz)	Part Number	Impedance (ohms)	Impedance Ratio	Insertion Loss (dB)	RF Power (W)	Package
0.05 - 3.072	MABA-009807-CF4010	75	4:1	1	0.25	SM-1
<b>0.05 - 200</b>	<b>ETC1-1T-2TR</b>	<b>50</b>	<b>1:1</b>	<b>0.1</b>	<b>0.25</b>	<b>SM-22</b>
<b>0.3 - 500</b>	<b>MABA-009180-500MHZ</b>	<b>50</b>	<b>1:1</b>	<b>0.5</b>	<b>0.25</b>	<b>SM-22</b>
0.07 - 200	ETC2-1T	50	2:1	2	0.25	SM-22
0.15 - 110	ETC4-1-4	50	4:1	1	0.25	SM-22
0.15 - 110	MABA-008570-ETC414	50	4:1	1	0.25	SM-22
0.3 - 200	MABACT0062	75	1:1	0.8	0.25	SM-22
0.3 - 200	MABA-009947-CF3160	75	1:5	0.7	0.25	SM-22
0.3 - 200	MABACT0071	75	1:1	0.5	0.25	SM-164
<b>0.3 - 200</b>	<b>MABAES0060</b>	<b>50</b>	<b>1:1</b>	<b>1.5</b>	<b>0.25</b>	<b>SM-22</b>
0.3 - 200	MABA-008482-CF1A40	75	1.78:1	1	1	SM-156
0.4 - 500	MABA-009487-60HWCA	50	1:1	0.4	0.25	SM-195
<b>0.5 - 1000</b>	<b>TP-103</b> ♦	—	<b>4:1</b>	<b>0.6</b>	<b>3</b>	<b>FP</b>
0.5 - 1000	TP-105 ♦	—	1.4:1	0.5	1.5	FP
<b>0.5 - 1500</b>	<b>TP-101</b> ♦	—	<b>1.6:1</b>	<b>0.5</b>	<b>3</b>	<b>FP</b>
<b>0.75 - 400</b>	<b>TP-104</b> ♦	—	<b>2:1</b>	<b>0.55</b>	<b>0.4</b>	<b>F</b>
1 - 100	MABA-010655	50	1:1	0.2	0.25	SMT
<b>1 - 350</b>	<b>MABA-007237-ETC410</b>	<b>50</b>	<b>4:1</b>	<b>1</b>	<b>0.25</b>	<b>SM-22</b>
1 - 350	MABA-007493-CF4160	75	4:1	1.6	0.25	SM-22
1 - 350	MABAES0040 ♦	50	2:1	2.6	0.25	SM-138
1 - 500	TP-102 ♦	—	4:1	0.75	1	FP
1 - 600	MABA-010079-420T60	50	4:1	1.0	0.25	SM-195
1 - 650	MABACT0064	75	4:1	3	0.25	SM-138
1 - 650	MABA-009298-CT48A0	50	4:1	2.23	0.25	SM-138
1 - 1600	MABA-010247-2R1250	50	2:1	1.0	0.25	SM-197
2 - 200	TP-75 ♦	—	1.5:1	0.25	10	SM
2 - 500	MABA-010143-FLUX18	50	8:1	0.5	0.25	SM-22
2 - 500	MABA-008937-TC11T5	50	1:1	1	0.25	SM-22
2 - 500	MABA-009484-CT0068	50	3:1	0.6	0.25	SM-22
<b>2 - 800</b>	<b>ETC4-1-2</b> ♦	<b>50</b>	<b>4:1</b>	<b>3</b>	<b>0.25</b>	<b>SM-22</b>
2 - 800	MABAES0061	50	4:1	3	0.25	SM-22
2 - 800	MABAES0010 ♦	50	4:1	2.2	0.25	SM-119
2 - 800	MABAES0015 ♦	50	4:1	3.5	0.25	SM-5
2 - 1000	MABA-007569-ETK42T	50	4:1	3	0.25	SM-22
<b>2 - 1000</b>	<b>MABA-009711-ETK2MM</b>	<b>50</b>	<b>4:1</b>	<b>1</b>	<b>0.25</b>	<b>SM-164B</b>
<b>2 - 1000</b>	<b>MABA-008752-TC1P57</b>	<b>50</b>	<b>1.5:1</b>	<b>0.5</b>	<b>0.25</b>	<b>SM-22</b>
2 - 1000	ETC1.5-7	50	1.5:1	1	0.25	SM-22
3 - 400	MABA-009126-ET11SM	50	1:1	1	0.5	SM-1
3 - 800	MABA-009488-61HWCA	50	4:1	0.6	0.25	SM-195
4.5 - 1000	MABACT0059	75	1:1	0.8	0.25	SM-22B
4.5 - 2000	MABA-010179-3WTTC1	50	1:1	0.8	3.0	SM-22
<b>4.5 - 3000</b>	<b>MABA-010125-TC1113</b>	<b>50</b>	<b>1:1</b>	<b>0.3</b>	<b>0.25</b>	<b>SM-22</b>
4.5 - 3000	MABA-007327-CT1490	75	1:1	1.6	0.25	SM-155
<b>4.5 - 3000</b>	<b>ETC1-1-13</b>	<b>50</b>	<b>1:1</b>	<b>2</b>	<b>0.25</b>	<b>SM-22</b>
<b>4.5 - 3000</b>	<b>MABA-007159-000000</b>	<b>50</b>	<b>1:1</b>	<b>2</b>	<b>0.25</b>	<b>SM-22</b>

Note: Part numbers are RoHS compliant ♦ indicates non-RoHS compliant

Blue listings indicate standard stock items widely available from our franchised distribution partners.

Detailed specifications for our standard parts can be found quickly on our website at [macomtech.com](http://macomtech.com) by typing the part number into the search box. All specifications are subject to change.

## Transformers (continued)

Frequency (MHz)	Part Number	Impedance (ohms)	Impedance Ratio	Insertion Loss (dB)	RF Power (W)	Package
4.5 - 3000	MABA-007327-CT1A40	75	1:1	2.5	0.25	SM-164
4.5 - 3000	MABA-008757-CT1160	50	1:1	4.2	0.25	SM-22B
5 - 50	MABA-007532-CF18A0	75	1:1	0.3	1	SM-138
5 - 65	MABA-007902-CF38A0	75	2.56:1	0.8	0.25	SM-138
5 - 65	MABA-007902-CF3840	75	2.56:1	0.8	0.25	SM-138
5 - 90	MABA-008282-CFGA40	75	16:1	1.9	0.25	SM-164
5 - 90	MABA-010181-CF9A40	75	1:9	1.3	0.63	—
5 - 100	MABA-009573-CF1A40	75	1.77:1	0.3	0.25	SM-164
5 - 100	MABA-009776-CF28A0	75	2:1	0.4	0.5	SM-164
5 - 100	MABACT0043	50	1:1	0.7	0.25	SM-138
5 - 100	MABA-008124-CF1FA0	75	1:1	0.7	0.25	SM-250-5
5 - 120	MABA-008182-CF1160	75	1:1	0.5	0.25	SM-22A
5 - 120	MABA-009005-CF1A40	75	1:1	0.3	0.25	SM-164A
5 - 120	MABA-008965-CF1160	75	1:1	0.3	0.25	SM-22A
5 - 120	MABA-009109-CF1A40	75	1:1	0.3	0.25	SM-164A
5 - 200	MABACT0048	75	2:1	0.4	0.25	SM-164
5 - 200	MABA-007819-CF48A0	—	4:1	0.9	0.05	SM-138-A
5 - 200	MABACT0056	75	1:1	0.9	0.25	SM-136
5 - 220	MABA-007488-CT9550	75	9:1	0.8	0.25	SM-55
5 - 350	MABACT0067	—	4:1	0.9	0.25	SM-164
5 - 350	MABA-007766-CF28A0	75	1.5:1	1.4	0.25	SM-138
<b>5 - 350</b>	<b>MABAES0025</b>	<b>—</b>	<b>1.5:1</b>	<b>1.4</b>	<b>0.25</b>	<b>SM-138</b>
5 - 400	ETC36-IT-2	50	36:1	12	0.25	SM-22
5 - 800	ETC3-1-1	50	3:1	2	0.25	SM-22
5 - 1000	MABACT0063	75	1.5:1	1	0.25	SM-22
5 - 1000	MABACT0066	75	4:1	1.5	0.25	SM-138
5 - 1000	MABACT0040	75	1:1	1.1	0.25	SM-164
5 - 1000	MABA-009092-CT1A40	75	1.33:1	1	0.25	SM-22A
5 - 1200	MABA-010129-CT4a40	75	1:4	0.8	0.63	—
5 - 1200	MABA-009232-CT4A4B	50	4:1	1.3	0.25	SM-187
5 - 1200	MABA-009231-CT1A4B	50	1:1	1.28	0.25	SM-187
5 - 1200	MABA-007748-CT1160	75	1:1	1.62	0.25	SM-22
5 - 1200	MABA-007681-CT2010	75	2:1	0.6	0.25	SM-118
5 - 1200	MABA-009492-C2W180	75	2:1	2.7	0.5	SM-164
5 - 1200	MABA-009691-CT1881	75	1:1	0.2	0.25	SM-136
5 - 3000	MABA-007871-CT1A40	50	1:1	2.5	0.25	SM-164
<b>5 - 3000</b>	<b>MABACT0039</b>	<b>75</b>	<b>1:1</b>	<b>2</b>	<b>0.25</b>	<b>SM-138</b>
5 - 3000	MABA-007489-CT18A0	75	1:1	0.8	0.25	SM-138
10 - 1500	TPX-75-4 ♦	—	1.5:1	0.25	2	SMA
10 - 2300	MABA-010273-ES1330	75	1.33:1	1.0	0.25	SM22
20 - 1000	MABAES0034 ♦	50	4:1	2.2	0.25	SM-22
30 - 2500	MABA-010012-ES4302	50	4:1	1.0	0.25	SM-22
50 - 870	MABA-008184-CT1760	75	1:1	0.5	0.25	SM-118A
50 - 1002	MABA-010245-CT1160	75	1:1	0.1	0.25	SM-22
50 - 1200	MABA-009057-CT19EO	75	1:1	1.23	0.25	SM-158
50 - 1200	MABA-009210-CT1760	75	1:1	0.63	0.25	SM-118A

Note: Part numbers are RoHS compliant ♦ indicates non-RoHS compliant

Blue listings indicate standard stock items widely available from our franchised distribution partners.

Detailed specifications for our standard parts can be found quickly on our website at [macomtech.com](http://macomtech.com) by typing the part number into the search box.

All specifications are subject to change.

Transformers (continued)

Frequency (MHz)	Part Number	Impedance (ohms)	Impedance Ratio	Insertion Loss (dB)	RF Power (W)	Package
50 - 1200	MABACT0069	75	1:1	0.8	0.25	SM-158
50 - 2150	MABA-00731-CT1980	75	1:1	1.2	0.25	SM-152
50 - 2150	MABA-007731-CT1980	75	1:1	1.2	1	SM-152
350 - 1125	TP-108 ♦	—	2.5:1	1	3	FP
500 - 2500	ETC1.6-4-2-3	50	4:1	3	0.25	SM-22
500 - 3000	MABA-007236-C16423	50	4:1	3	0.25	SM-22
500 - 3000	MABACT0065	50	4:1	3	0.25	SM-22
760 - 960	ETC1-1-6	50	1:1	2	0.25	SM-22
1710 - 1910	ETC1-1-10	50	1:1	2	0.5	SM-22
1800 - 4100	MABA-010352-CT1A40	50	1:1	3.0	0.25	SM-197

Designer's Kit  
MABA-000001-50KIT1 (electrical specifications of each model)

Frequency (MHz)	Part Number	$\Omega$ ratio	Insertion Loss			Configuration
			3 dB MHz	2 dB MHz	1 dB MHz	
3 - 500	MABA-009180-500MHZ	1:1	0.40-500	0.50-300	1-100	D
760 - 960	ETC1-1-6TR	1:1	-	760-960	-	C
1710 - 1910	ETC1-1-10TR	1:1	-	1710-1910	-	B
5 - 1200	MABA-009602-ES2922	1:1	-	600-1200	5-600	C
4.5 - 3000	MABA-007159-000000	1:1	2000-2800	1000-2000	4.5-1000	A
4.5 - 3000	MABA-010125-TC1113	1:1	2000-3000	1000-2000	4.5-1000	A
1 - 350	MABA-009250-CT0068	1:2	-	-	3-300	D
2 - 500	MABA-009484-ETC31T	1:3	-	-	2-500	D
3 - 800	MABAES0061	1:4	2-800	5-600	10-100	D
2 - 1000	MABA-009711-ETK2MM	1:4	700-1000	500-700	3-500	E
6 - 1000	MABA-008639-TC41T7	1:4	600-1000	6-600	-	E
500 - 2500	MABA-007236-C16423	1:4	500-3000	-	750-1200	E
2 - 500	MABA-010143-FLUX18	1:8	-	2-500	-	D
0 - 75	ETC9-1T-5TR	1:9	-	10-75	-	D
5 - 40	ETC16-1T-2TR	1:16	-	-	5-40	D

Transformers ranging from 1 to 3000 MHz

- Very wide bandwidth
- Termination finish, both gold over nickel-plated and tin-plated
- Various surface mount parts
- RoHS compliant

Each kit contains: 15 models x 10 of each = 150 total



Configurations

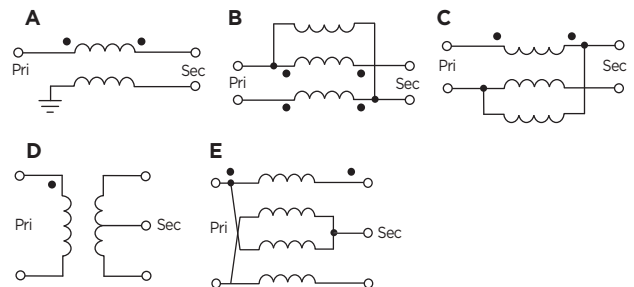

Note: Part numbers are RoHS compliant ♦ indicates non-RoHS compliant

Blue listings indicate standard stock items widely available from our franchised distribution partners.

Detailed specifications for our standard parts can be found quickly on our website at [macomtech.com](http://macomtech.com) by typing the part number into the search box.

All specifications are subject to change.



CATV Transformers

Frequency (MHz)	Part Number	Impedance (ohms)	Impedance Ratio	Insertion Loss (dB)	RF Power (W)	Package
0.3 - 200	MABACT0062	75	1:1	0.8	0.25	SM-22
0.3 - 200	MABA-009947-CF3160	75	1:5	0.7	0.25	SM-22
0.3 - 200	MABACT0071	75	1:1	0.5	0.25	SM-164
0.3 - 200	MABA-008482-CF1A40	75	1.78:1	1	1	SM-156
1 - 350	MABA-007493-CF4160	75	4:1	1.6	0.25	SM-22
1 - 650	MABACT0064	75	4:1	3	0.25	SM-138
4.5 - 1000	MABACT0059	75	1:1	0.8	0.25	SM-22B
4.5 - 3000	MABA-007327-CT1A40	75	1:1	2.5	0.25	SM-164
5 - 50	MABA-007532-CF18A0	75	1:1	0.3	1	SM-138
5 - 65	MABA-007902-CF38A0	75	2.56:1	0.8	0.25	SM-138
5 - 90	MABA-008282-CFGA40	75	16:01	1.9	0.25	SM-164
5 - 90	MABA-010181-CF9A40	75	1:9	1.3	0.63	—
5 - 100	MABA-009573-CF1A40	75	1.77:1	0.3	0.25	SM-164
5 - 100	MABA-009776-CF28A0	75	2:1	0.4	0.5	SM-164
5 - 100	MABA-008124-CF1FA0	75	1:1	0.7	0.25	SM-250-5
5 - 100	MABA-010061-CF4FA0	75	4:1	1.2	0.63	SMT
5 - 120	MABA-009005-CF1A40	75	1:1	0.3	0.25	SM-164A
5 - 120	MABA-008965-CF1160	75	1:1	0.3	0.25	SM-22A
5 - 120	MABA-009109-CF1A40	75	1:1	0.3	0.25	SM-164A
5 - 200	MABACT0048	75	2:1	0.4	0.25	SM-164
5 - 200	MABACT0056	75	1:1	0.9	0.25	SM-136
5 - 200	MABA-009836-CF48A0	75	4:1	0.9	0.5	SM-138
5 - 200	MABA-011002	75	4:1	0.4	1	SMT
5 - 220	MABA-007488-CT9550	75	9:1	0.8	0.25	SM-55
5 - 350	MABA-007766-CF28A0	75	1.5:1	1.4	0.25	SM-138
5 - 400	MABA-010721	75	1:1	0.5	0.25	SMT
5 - 1000	MABACT0063	75	1.5:1	1	0.25	SM-22
5 - 1000	MABACT0066	75	4:1	1.5	0.25	SM-138
5 - 1000	MABACT0040	75	1:1	1.1	0.25	SM-164
5 - 1000	MABA-009092-CT1A40	75	1.33:1	1	0.25	SM-22A
5 - 1200	MABA-010129-CT4A40	75	4:1	0.8	0.63	—
5 - 1200	MABA-007748-CT1160	75	1:1	1.62	0.25	SM-22
5 - 1200	MABA-007681-CT2010	75	2:1	0.6	0.3	SM-118
5 - 1200	MABA-009492-C2W180	75	2:1	2.7	0.5	SM-164
5 - 1200	MABA-009691-CT1881	75	1:1	0.2	0.25	SM-136
5 - 3000	MABACT0039	75	1:1	2	0.25	SM-138
5 - 3000	MABA-007489-CT18A0	75	1:1	0.8	0.25	SM-138
10 - 2300	MABA-010273-ES1330	75	1.33:1	1	0.25	SM22
50 - 870	MABA-008184-CT1760	75	1:1	0.5	0.25	SM-118A
50 - 1002	MABA-010245-CT1160	75	1:1	0.1	0.25	SM-22
50 - 1200	MABA-009057-CT19EO	75	1:1	1.23	0.25	SM-158
50 - 1200	MABA-009210-CT1760	75	1:1	0.63	0.25	SM-118A
50 - 1200	MABACT0069	75	1:1	0.8	0.25	SM-158
50 - 2150	MABA-00731-CT1980	75	1:1	1.2	0.25	SM-152
50 - 2150	MABA-007731-CT1980	75	1:1	1.2	1	SM-152

Note: Part numbers are RoHS compliant ◆ indicates non-RoHS compliant

Blue listings indicate standard stock items widely available from our franchised distribution partners.

Detailed specifications for our standard parts can be found quickly on our website at [macomtech.com](http://macomtech.com) by typing the part number into the search box.

All specifications are subject to change.

## Capacitors

Capacitance (pf)	Part Number	Pad Types	Standoff Voltage (V)	Package
<b>Die Products</b>				
50	MA4M1050	Round Bonding Pad	100	Die
100	MA4M1100	Round Bonding Pad	100	Die
10	MA4M3010	Square Bonding Pad	200	Die
30	MA4M3030	Square Bonding Pad	200	Die
50	MA4M3050	Square Bonding Pad	200	Die
100	MA4M3100	Square Bonding Pad	50	Die
150	MA4M3150	Square Bonding Pad	50	Die

## Inductors

Self Resonant Frequency (MHz)	Part Number	Inductance (nH)	Qmin	Package
30 - 90	MALX-010136-80NHIN	80	80	SM-199
30 - 512	MABA-010371-051837	30	—	SM-200
480	EIN8 ◆	273	90	SM-52
570	EIN9 ◆	246	90	SM-52
580	EIN11 ◆	165	90	SM-52
635	EIN12 ◆	193	90	SM-52
700	EIN10 ◆	180	90	SM-52
800	EIN14 ◆	146	90	SM-52
840	EIN15 ◆	123	90	SM-52
970	EIN13 ◆	97	90	SM-52
1440	EIN16 ◆	53	90	SM-52

## Power Splitters/Combiners

Frequency (MHz)	Part Number	Impedance (ohms)	Channels	Isolation (dB)	Phase Balance (degrees)	Amplitude Balance (dB)	Package
0.2 - 300	DS-310 ◆	50	4	25	4	0.2	FP-5
0.4 - 400	DS-113 ◆	50	2	25	1	0.15	FP-2
0.4 - 400	DSS-113 ◆	50	2	25	1.5	0.15	SF-1
1 - 100	M3H-50 ◆	50	3	55	0.5	0.1	TO-5
1 - 100	MTH-50 ◆	50	2	30	1	0.1	TO-5-1
1 - 300	DS-117 ◆	50	3	20	4	0.25	FP
1 - 2700	MAPD-008957-CT0012	50	2	20	2	1.5	SM-156
2 - 200	THV-50 ◆	50	2	35	0.5	0.1	Conn
2 - 1000	GS-4-7TR ◆	50	4	23	10	0.5	SM-46
2 - 1000	MAPD-007246-ES4700	50	4	23	10	0.5	SM-46
2 - 2000	DS-4-4 ◆	50	4	30	2	0.5	Conn
2 - 2000	H-8-4 ◆	50	2	35	1	0.05	Conn
3 - 700	DS-328 ◆	50	3	20	4	0.4	TO-8-2
5 - 100	MAPDCT0010 ◆	75	2	32	2.5	0.25	SM-150

(continued on page 48)

Note: Part numbers are RoHS compliant ◆ indicates non-RoHS compliant

Blue listings indicate standard stock items widely available from our franchised distribution partners.

Detailed specifications for our standard parts can be found quickly on our website at [macomtech.com](http://macomtech.com) by typing the part number into the search box.

All specifications are subject to change.

Power Splitters/Combiners (continued)

Frequency (MHz)	Part Number	Impedance (ohms)	Channels	Isolation (dB)	Phase Balance (degrees)	Amplitude Balance (dB)	Package
5 - 120	ESSM-2-9-75 ◆	75	2	21	2	0.5	SM-53
5 - 200	MAPD-008109-C30040	75	3	28	—	—	SM-4
5 - 500	DS-309 ◆	50	8	30	2	0.15	C-18
5 - 500	DS-318 ◆	50	2	18	2	0.2	RH-1
5 - 500	ESML-2-1 ◆	50	2	30	5	0.6	SM-24
5 - 500	MAPD-007249-ESML21	50	2	30	3	0.3	SM-24
5 - 900	MAPD-008072-ESSM26	50	2	28	3	0.3	SM-1
<b>5 - 1000</b>	<b>DS-327 ◆</b>	<b>50</b>	<b>2</b>	<b>20</b>	<b>3</b>	<b>0.2</b>	<b>FP-2</b>
5 - 1000	DSS-327 ◆	50	2	16	3	0.3	SF-1
<b>5 - 1000</b>	<b>ELPD-20-1 ◆</b>	<b>75</b>	<b>2</b>	<b>22</b>	<b>4</b>	<b>0.5</b>	<b>SM-93</b>
<b>5 - 1000</b>	<b>ESSMJ-2-12-75 ◆</b>	<b>75</b>	<b>2</b>	<b>30</b>	<b>—</b>	<b>0.3</b>	<b>SM-44</b>
5 - 1000	ESSM-2-2-75 ◆	75	2	18	6	0.6	SM-55
5 - 1000	H-81-4 ◆	50	2	25	2	0.1	Conn
<b>5 - 1000</b>	<b>MACPES0007 ◆</b>	<b>75</b>	<b>2</b>	<b>21</b>	<b>—</b>	<b>—</b>	<b>Surface Mount</b>
5 - 1000	MAPDCT0002 ◆	75	2	32	1.5	0.4	SM-150
5 - 1000	MAPDCT0005 ◆	75	3	22	4	0.3	SM-4
5 - 1000	MAPDCT0027	75	2	20	1	0.32	SM-55A
5 - 1000	MAPD-008108-C202C0	75	2	30	—	—	SM-44
5 - 1000	MAPDCT0028	75	4	21	1	0.3	SM-46
5 - 1000	MAPDCT0029	75	2	21	1	0.28	SM-55
5 - 1000	MAPDCT0030	75	2	20	1.5	0.4	SM-150
5 - 1000	MAPDCT0013	75	2	18	1.5	0.15	SM-156
<b>5 - 1000</b>	<b>ESSM-2-8-75</b>	<b>—</b>	<b>2</b>	<b>10</b>	<b>—</b>	<b>—</b>	<b>SM-55</b>
5 - 1000	MAPD-007778-C402E0	—	4	21	—	—	SM-46
5 - 1000	MAPDCT0033	75	2	22	0.8	0.1	SM-139
5 - 1000	MAPD-009918-C209C0	75	2	30	0.9	0.3	SM-156
5 - 1000	MAPD-010038-C209C0	75	2	30	0.9	0.3	SM-156
5 - 1000	MAPD-009675-C2DA40	75	2	32	1.5	0.4	SM-150
5 - 1000	MAPD-009278-ST1000	50	2	20	4	0.6	SM-156
5 - 1000	MAPD-008812-0003HW	50	3	28	1.5	0.1	SM-4
5 - 1000	MAPD-009673-C2DA40	75	2	20	1.5	0.4	SM-150
5 - 1200	MAPD-009492-C2W180	75	2	—	11	3.4	SM-164
5 - 1200	MAPD-009492-C2W180	75	2/180°	—	4	2.4	SM-164
5 - 1200	MAPDCT0032	75	4	24	3	0.3	SM-4
5 - 1200	MAPDCT0024	75	2	—	2.1	0.27	SM-169
5 - 1600	MAPD-011002	75	2	30	0.7	0.3	SMT
5 - 2150	MAPD-011007	75	2	34	0.8	0.3	SMT
5 - 2400	MAPDCT0026	75	2	18	4	1.3	SM-156
5 - 2400	MAPDCT0012 ◆	75	2	18	2	0.2	SM-156
<b>10 - 500</b>	<b>DS-109 ◆</b>	<b>50</b>	<b>2</b>	<b>35</b>	<b>1</b>	<b>0.15</b>	<b>FP-2</b>
10 - 500	DS-112 ◆	50	4	25	5	0.2	FP-5
10 - 500	DS-312 ◆	50	4	25	2	0.2	C-14
<b>10 - 500</b>	<b>DS-319 ◆</b>	<b>50</b>	<b>2</b>	<b>25</b>	<b>1</b>	<b>0.2</b>	<b>TO-8-2</b>
10 - 500	DSS-333 ◆	50	2	25	2	0.15	SF-1
10 - 1000	T-1000 ◆	50	2	45	1	0.1	Conn
10 - 1000	ESML-2-4 ◆	50	2	15	5	0.7	SM-24
<b>10 - 2000</b>	<b>DS-313 ◆</b>	<b>50</b>	<b>2</b>	<b>23</b>	<b>4</b>	<b>0.3</b>	<b>FP-2</b>
<b>10 - 2000</b>	<b>DSS-313 ◆</b>	<b>50</b>	<b>2</b>	<b>22</b>	<b>5</b>	<b>0.3</b>	<b>SF-1</b>

Note: Part numbers are RoHS compliant ◆ indicates non-RoHS compliant

Blue listings indicate standard stock items widely available from our franchised distribution partners.

Detailed specifications for our standard parts can be found quickly on our website at [macomtech.com](http://macomtech.com) by typing the part number into the search box.

All specifications are subject to change.

Power Splitters/Combiners (continued)

Frequency (MHz)	Part Number	Impedance (ohms)	Channels	Isolation (dB)	Phase Balance (degrees)	Amplitude Balance (dB)	Package
<b>10 - 2000</b>	<b>DS-409-4</b> ◆	<b>50</b>	<b>4</b>	<b>30</b>	<b>2</b>	<b>0.1</b>	<b>Conn</b>
10 - 2000	PD10-0042-S	50	2	23	6	0.4	FP-2
20 - 400	TU-50 ◆	50	2	40	1	0.1	Conn
20 - 2000	DS-808-4 ◆	50	8	30	2	0.1	Conn
<b>25 - 1000</b>	<b>DS-323</b> ◆	<b>50</b>	<b>3</b>	<b>24</b>	<b>4</b>	<b>0.4</b>	<b>FP-3</b>
25 - 1000	DS-324 ◆	50	4	20	6	0.25	FP-5
30 - 1200	MAPD-011003	75	3	25	1	0.1	SMT
40 - 400	MTV-50 ◆	50	2	30	2	0.2	TO-5-1
40 - 820	MAPDCT0004 ◆	75	2	40	0.5	0.5	SM-55
40 - 1000	MAPD-007874-C20960	75	2	25	3	0.35	SM-138
50 - 70	MAPD-010320-5070HR	50	2	32	0.3	.5	SM-89
50 - 300	M3V-50 ◆	50	3	40	1	0.1	TO-5
50 - 120	MAPD-008185-C20720	75	2	21	—	—	SM-114
112 - 168	MAPD-009850-HW1268	50	2	23	1	1	SM-89
220-470	MAPD-009851-HW2247	50	2	23	1	1	SM-89
750 - 1500	DS-331 ◆	50	2	10	6	0.2	TO-8
800 - 900	QH01-0016-G ◆	50	2	17	1.5	0.3	SOT-26
800 - 900	MAHYCC0001	50	2	17	1.5	0.3	SOT-26
800 - 980	MAPD-000900-12920T	50	2	27	1	0.2	SOT-26
800-2200	MAPD-010201-8022CG	50	2	19	1	1.5	SM-156
820 - 980	ELPD-290 ◆	50	2	20	7	1.2	SM-8
824 - 896	MAPDCC0016	50	5	26	5	0.2	SOIC-16
824 - 960	MAPDCC0001	50	2	23	0.5	0.05	SOIC-8
824 - 960	MAPDCC0011	50	2	15	3	0.1	SOT-26
824 - 960	MAPDCC0005	50	3	18	2	0.6	SOIC-8
824 - 960	MAPDCC0007	50	4	23	2	0.3	SOW-16
824 - 960	MAPDCC0009	50	4	24	3	0.3	SOIC-8
824 - 960	MAPDCC0017	50	6	25	6	0.2	SOW-16
824 - 960	MAPDCC0019	50	6	25	4	0.5	SOIC-16
824 - 960	MAPDCC0021	50	8	30	5	0.4	SSOP-20
850 - 950	MAHYB900-1292T ◆	50	3	18	2	0.4	SOT-26
1000 - 2000	DS-332 ◆	50	2	10	6	0.2	TO-8
1000 - 18000	2089 Series ◆	50	2	20	4	0.2	Conn
1000 - 18000	2090-6204-00 ◆	50	2	23	5	0.3	Conn
1000 - 18000	2090 Series ◆	50	2	20	5	0.3	Conn
1510 - 1660	MAPDCC0003	50	2	20	1	0.05	SOIC-8
1700 - 1900	MAPDCC0004	50	2	20	2	0.1	SOIC-8
1700 - 2000	MAPD-007530-000/00	50	2	20	1.5	0.2	SOT-26
1700 - 2000	MAPDCC0008	50	4	18	4	0.1	SOW-16
1700 - 2000	MAPDCC0014	50	4	23	5	0.8	SOIC-16
1700 - 2000	MAPDCC0018	50	6	22	8	0.5	SOW-16
1700 - 2000	MAPDCC0020	50	6	25	4	0.5	SOIC-16
1850 - 1990	MAPDCC0002	50	2	21	1	0.05	SOIC-8
1850 - 1990	MAPDCC0006	50	3	18	7	0.3	SOIC-8
1850 - 1990	MAPDCC0015	50	5	28	6	0.2	SOIC-16
2000 - 18000	2090-6205-00 ◆	50	2	23	5	0.3	Conn
2200 - 2500	MAPDCC0010	50	2	22	2	0.1	SOT-25
3650 - 4050	MAHYB390-1303T ◆	50	3	20	3	1.4	2 mm MLP
8000 - 18000	2090-6210-00 ◆	50	2	18	5	0.3	Conn

Note: Part numbers are RoHS compliant ◆ indicates non-RoHS compliant

Blue listings indicate standard stock items widely available from our franchised distribution partners.

Detailed specifications for our standard parts can be found quickly on our website at [macomtech.com](http://macomtech.com) by typing the part number into the search box.

All specifications are subject to change.

CATV Power Splitters/Combiners

Frequency (MHz)	Part Number	Channels	Insertion Loss (dB)	Isolation (dB)	Amplitude Balance (dB)	Return Loss (dB)	Package
5 - 100	MAPDCT0010 ◆	2	0.3	32	0.25	27	SM-150
5 - 120	ESSM-2-9-75 ◆	2	0.3	21	0.5	—	SM-114
5 - 200	MAPD-008109-C30040	3	0.28	28	0.1	34	SM-4
5 - 1000	ELPD-20-1 ◆	2	1.0	22	0.5	12	SM-139
5 - 1000	ESSMJ-2-12-75 ◆	2	0.9	30	0.5	19	SM-44
5 - 1000	MACPES0007 ◆	2	0.8	17	0.6	22	SM-127
5 - 1000	MAPDCT0002 ◆	2	1.1	32	0.2	24	SM-150
5 - 1000	MAPDCT0013	2	1.1	18	0.15	25	SM-156
5 - 1000	MAPDCT0027	2	0.7	20	0.32	26	FR4
5 - 1000	MAPDCT0029	2	0.7	20	0.28	26	SM-55
5 - 1000	MAPDCT0030	2	1.1	20	0.4	24	SM-150
5 - 1000	MAPDCT0033	2	1.0	22	0.1	25	SM-139
5 - 1000	MAPD-008108-C202C0	2	0.5	30	0.5	19	SM-44
5 - 1000	MAPD-009673-C2DA40	2	0.5	20	0.4	24	SM-150
5 - 1000	MAPD-009918-C209C0	2	0.7	38	0.3	29	SM-156
5 - 1000	MAPD-010038-C209C0	2	0.65	38	0.3	30	SM-156
5 - 1000	MAPDCT0005 ◆	3	1.9	22	0.3	26	SM-4
5 - 1000	MAPDCT0028	4	1.1	21	0.3	17	SM-46
5 - 1200	MAPD-009492-C2W180	2/180°	2.7	—	3.4	18	SM-164
5 - 1200	MAPDCT0024	2	4.29	—	0.27	23	SM-169
5 - 1200	MAPD-009492-C2W180	2	2.7	—	3.4	18	SM-164
5 - 1200	MAPDCT0032	3	2.2	24	0.3	18	SM-4
5 - 2400	MAPDCT0026	2	2.8	18	1.3	9	SM-156
5 - 2400	MAPDCT0012 ◆	2	2.8	18	1.3	9	SM-156
40 - 820	MAPDCT0004 ◆	2	—	40	0.5	—	SM-55
40 - 1000	MAPD-007874-C20960	2	1.0	25	0.2	18	SM-150
50 - 120	MAPD-008185-C20720	2	0.3	21	0.5	—	SM-114

Couplers

Frequency (MHz)	Part Number	Impedance (ohms)	Coupling (dB)	Insertion Loss (dB)	Max. Power (W)	Isolation (dB)	Package
0.2 - 35	HH-108 ◆	50	3.5	0.1	25	40	SMA
0.5 - 400	CH-137 ◆	50	20	0.5	3	30	RH
0.5 - 400	CHS-137 ◆	50	20	0.5	3	30	SMT
1 - 1000	CH-132 ◆	50	20	0.7	5	20	SMA/BNC
2 - 32	CD-920-4 ◆	50	20	0.2	50	40	BNC
2 - 32	CH-130-4 ◆	50	30	0.1	500	30	SMA/BNC
2 - 200	HH-106 ◆	50	—	1	1	30	FP
2 - 200	HH-107 ◆	50	—	1	1	30	SMA/BNC
2 - 2000	H-9 ◆	50	4	0.4	25	55	SMA/N
5 - 120	MACPCT0017 ◆	75	17.3	—	—	45	Surface Mount
5 - 120	MACP-008249-CH09B0	75	17	-0.4	0.25	-45	SM-155
5 - 200	HH-109 ◆	50	—	1.4	0.5	30	FP
5 - 200	HHS-109 ◆	50	—	1.4	0.5	30	SMT
5 - 862	MACP-009821-CG0650	75	16	25	0.25	33	SM-101

Note: Part numbers are RoHS compliant ◆ indicates non-RoHS compliant

Blue listings indicate standard stock items widely available from our franchised distribution partners.

Detailed specifications for our standard parts can be found quickly on our website at [macomtech.com](http://macomtech.com) by typing the part number into the search box.

All specifications are subject to change.

Couplers (continued)

Frequency (MHz)	Part Number	Impedance (ohms)	Coupling (dB)	Insertion Loss (dB)	Max. Power (W)	Isolation (dB)	Package
5 - 870	MACP-008248-CH0670	75	17	0.9	1	—	SM-103-A
5 - 870	ELDC-10 ♦	75	10	1	0.25	21	SM-55
5 - 870	MACPCT0038	75	17	0.6	0.25	32	SM-103
5 - 870	MACPES0004 ♦	75	10	1.3	0.25	28	SM-132
5 - 1000	ELDC-14 ♦	75	14.3	1	0.25	34	SM-55
5 - 1000	ELDC-16 ♦	75	16	0.9	0.25	28	SM-55
5 - 1000	CH-140 ♦	50	19.75	0.3	3	20	FP
5 - 1000	ELDC-20 ♦	75	20	0.6	0.25	29	SM-55
5 - 1000	ELDC-7 ♦	75	7	2.5	0.25	22	SM-55
5 - 1000	ELDC-8X1 ♦	75	8	2.1	0.25	13.5	SM-55
5 - 1000	EMD-10-1	50	10	1.2	0.25	15	SM-22
<b>5 - 1000</b>	<b>EMDC-10-1-75 ♦</b>	<b>75</b>	<b>10</b>	<b>1.5</b>	<b>0.25</b>	<b>12</b>	<b>SM-22</b>
5 - 1000	EMDC-13-1-75 ♦	75	13	1.5	0.25	13	SM-22
5 - 1000	MACP-007486-CH0010	75	17	0.7	0.25	—	SM-1
5 - 1000	MACP-007490-CA0010	75	10.5	1.4	0.25	—	SM-1
<b>5 - 1000</b>	<b>MACPCT0020</b>	<b>75</b>	<b>—</b>	<b>—</b>	<b>0.25</b>	<b>—</b>	<b>SM-155</b>
5 - 1000	MACP-008125-CK07F0	75	20	0.4	0.25	40	SM-127
5 - 1000	MACP-008764-CH0370	75	17	0.5	0.25	—	SM-55
5 - 1000	MACP-008311-CE0370	75	14	0.8	0.25	—	SM-55
<b>5 - 1000</b>	<b>MACP-009404-C80370</b>	<b>75</b>	<b>8</b>	<b>2.1</b>	<b>0.25</b>	<b>—</b>	<b>SM-55</b>
5 - 1000	MACP-009736-CD0160	75	13	1.4	0.25	—	SM-22
5 - 1000	EMDC-13-2	75	13	1.4	0.25	13	SM-22
5 - 1000	EMDC-17-1-75 ♦	75	17	0.9	0.25	24	SM-22
5 - 1000	EMDC-17-5-75 ♦	75	17	0.8	0.25	29	SM-127
5 - 1000	EMDC-17-8-75 ♦	75	17	0.8	0.25	29	SM-127
5 - 1000	H-1-4 ♦	50	4	1.2	7	45	SMA/BNC
5 - 1000	MACPCT0039	75	10	1.6	0.25	23	SM-138
5 - 1000	MACPES0050 ♦	75	20	0.8	0.25	37	SM-55
5 - 1000	MACP-009943-CH07F0	75	17	0.8	0.25	22	SM-55A
5 - 1200	MACP-009730-C60370	75	6	3.3	0.25	16	SM-55
5 - 1200	MACP-010249-C108A0	75	18	0.6	0.25	0.25	24_
5 - 1200	MACP-007727-C107B0	75	18.7	1.4	0.25	26.25	SM-123
5 - 1200	MACPCT0030	75	16.8	1.2	0.25	27	SM-55
<b>5 - 1200</b>	<b>MACPES0017</b>	<b>75</b>	<b>17.1</b>	<b>0.8</b>	<b>0.25</b>	<b>—</b>	<b>SM-103</b>
5 - 1200	MACP-007741-CG09E0	75	17	0.8	0.25	—	SM-22
5 - 1200	MACP-009467-105T12	50	10	0.5	0.25	15	SM-22
6 - 600	EMDC-16-1	50	16	0.6	0.25	21	SM-22
7 - 14	JH-113 ♦	50	—	0.5	4	20	FP
7 - 14	JHS-113 ♦	50	—	0.5	4	20	SMT
10 - 500	CH-134 ♦	50	10.8	1.6	1	20	FP
10 - 500	CH-138 ♦	50	10.8	1.6	1	17	TO-8
10 - 500	CHS-134 ♦	50	10.8	1.6	1	20	SMT
10 - 500	HH-110 ♦	50	—	1.4	1	20	FP
10 - 500	HH-127 ♦	50	—	1.4	1	20	TO-8
10 - 500	HHS-110 ♦	50	—	1.4	1	20	SMT
15 - 1000	MACPCT0040	50	9.9	1.3	0.25	25	SM-22B

(continued on page 52)

Note: Part numbers are RoHS compliant ♦ indicates non-RoHS compliant

Blue listings indicate standard stock items widely available from our franchised distribution partners.

Detailed specifications for our standard parts can be found quickly on our website at [macomtech.com](http://macomtech.com) by typing the part number into the search box.

All specifications are subject to change.



Couplers (continued)

Frequency (MHz)	Part Number	Impedance (ohms)	Coupling (dB)	Insertion Loss (dB)	Max. Power (W)	Isolation (dB)	Package
20 - 40	JH-114 ♦	50	3	0.5	5	20	FP
20 - 40	JH-133 ♦	50	3	0.5	5	20	TO-8
20 - 40	JHS-114 ♦	50	—	0.5	5	20	SMT
20 - 140	JH-10-4 ♦	50	1	0.6	4	20	SMA
20 - 200	JH-131 ♦	50	—	1	0.25	20	SMA
20 - 300	HH-105 ♦	50	—	1	0.5	28	TO-5
20 - 2000	HH-128 ♦	50	—	3	0.5	15	FP
30 - 1000	DCG-10-4 ♦	50	11	1.5	5	30	SMA
30 - 3000	H-183-4 ♦	50	4.5	0.7	5	35	SMA
40 - 80	JH-115 ♦	50	3	0.5	5	20	FP
40 - 80	JHS-115 ♦	50	3	0.5	1	20	SMT
40 - 1000	EMDC-16-2-75 ♦	75	16	0.6	0.25	23	SM-55
40 - 1000	MACPES0028 ♦	75	7	1.9	0.25	22	SM-137
50 - 450	EMDC-20-1	50	20	0.3	0.25	15	SM-22
50 - 450	MACP-007984-MDC201	50	20	0.3	0.25	15	SM-22
80 - 160	JH-119 ♦	50	3	0.75	4	20	FP
80 - 160	JHS-119 ♦	50	3	0.75	4	20	SMT
100 - 200	JH-121 ♦	50	—	0.75	4	20	FP
100 - 200	JHS-121 ♦	50	—	0.75	4	20	SMT
136 - 174	MACP-010121-B8180X	50	20	0.2	7	35	SM-55B
175 - 350	JH-136 ♦	50	—	0.5	4	20	FP
175 - 350	JHS-136 ♦	50	—	0.5	4	20	SMT
200 - 400	JHS-142 ♦	50	0	0.5	5	18	SMT
<b>250 - 500</b>	<b>JH-139 ♦</b>	<b>50</b>	<b>—</b>	<b>0.5</b>	<b>4</b>	<b>15</b>	<b>FP</b>
250 - 500	JHS-139 ♦	50	—	0.5	4	15	SMT
500 - 1000	2020-6600-06 ♦	50	6	0.15	50	31	Conn
500 - 1000	2020-6601-10 ♦	50	10	0.15	50	35	Conn
500 - 1000	2020-6602-20 ♦	50	20	0.15	50	45	Conn
500 - 1000	2020-6603-30 ♦	50	30	0.15	50	55	Conn
<b>500 - 1000</b>	<b>JH-140 ♦</b>	<b>50</b>	<b>—</b>	<b>0.3</b>	<b>25</b>	<b>18</b>	<b>FP</b>
500 - 18000	2025Series ♦	50	6-20	0.3-0.7	50	15-22	Conn
500 - 18000	2026-6010-10 ♦	50	10	0.9	50	15	Conn
500 - 18000	2026-6012-20 ♦	50	20	0.9	50	15	Conn
500 - 18000	203XSeries ♦	50	3	0.2	—	25	Conn
824 - 960	MACPCC0002	50	17	0.3	2	32	SOIC-8
1000 - 2000	2020-6604-06 ♦	50	6	0.2	50	31	Conn
1000 - 2000	2020-6605-10 ♦	50	10	0.2	50	35	Conn
1000 - 2000	2020-6606-20 ♦	50	20	0.2	50	45	Conn
1000 - 2000	2020-6607-30 ♦	50	30	0.2	50	55	Conn
1000 - 2000	JH-141 ♦	50	—	0.3	25	18	FP
1000 - 12400	2026-6001-10 ♦	50	10	0.35	50	18	Conn
1000 - 12400	2026-6003-20 ♦	50	20	0.35	50	17	Conn
1000 - 18000	2026-6007-10 ♦	50	10	0.3	50	15	Conn
1000 - 18000	2026-6009-20 ♦	50	20	0.3	50	17	Conn
1700 - 2000	MACPCC0001	50	17	0.3	2	34	SOIC-8

Note: Part numbers are RoHS compliant ♦ indicates non-RoHS compliant

Blue listings indicate standard stock items widely available from our franchised distribution partners.

Detailed specifications for our standard parts can be found quickly on our website at [macomtech.com](http://macomtech.com) by typing the part number into the search box.

All specifications are subject to change.

Couplers (continued)

Frequency (MHz)	Part Number	Impedance (ohms)	Coupling (dB)	Insertion Loss (dB)	Max. Power (W)	Isolation (dB)	Package
2000 - 4000	2020-6608-06 ◆	50	6	0.2	50	28	Conn
2000 - 4000	2020-6609-10 ◆	50	10	0.2	50	32	Conn
2000 - 4000	2020-6610-20 ◆	50	20	0.2	50	42	Conn
2000 - 4000	2020-6611-30 ◆	50	30	0.2	50	52	Conn
2000 - 18000	2026-6004-10 ◆	50	10	30	50	15	Conn
2000 - 18000	2026-6006-20 ◆	50	20	30	50	18	Conn
2600 - 5200	2020-6612-06 ◆	50	6	0.25	50	26	Conn
2600 - 5200	2020-6613-10 ◆	50	10	0.25	50	30	Conn
2600 - 5200	2020-6614-20 ◆	50	20	0.25	50	40	Conn
2600 - 5200	2020-6615-30 ◆	50	30	0.25	50	50	Conn
4000 - 8000	2020-6616-06 ◆	50	6	0.25	50	28	Conn
4000 - 8000	2020-6617-10 ◆	50	10	0.25	50	30	Conn
4000 - 8000	2020-6618-20 ◆	50	20	0.25	50	40	Conn
4000 - 8000	2020-6619-30 ◆	50	30	0.25	50	50	Conn
7000 - 12400	2020-6620-06 ◆	50	6	0.4	50	21	Conn
7000 - 12400	2020-6621-10 ◆	50	10	0.4	50	30	Conn
7000 - 12400	2020-6622-20 ◆	50	20	0.3	50	38	Conn
7000 - 12400	2020-6623-30 ◆	50	30	0.3	50	47	Conn
7000 - 18000	2020-6624-06 ◆	50	6	0.6	50	21	Conn
7000 - 18000	2020-6625-10 ◆	50	10	0.4	50	30	Conn
7000 - 18000	2020-6626-20 ◆	50	20	0.5	50	35	Conn
7000 - 18000	2020-6627-30 ◆	50	30	0.5	50	45	Conn
12400 - 18000	2020-6628-06 ◆	50	6	0.6	50	21	Conn
12400 - 18000	2020-6629-10 ◆	50	10	0.4	50	30	Conn
12400 - 18000	2020-6630-20 ◆	50	20	0.5	50	35	Conn
12400 - 18000	2020-6631-30 ◆	50	30	0.5	50	42	Conn

Note: Part numbers are RoHS compliant ◆ indicates non-RoHS compliant

Blue listings indicate standard stock items widely available from our franchised distribution partners.

Detailed specifications for our standard parts can be found quickly on our website at [macomtech.com](http://macomtech.com) by typing the part number into the search box.

All specifications are subject to change.

CATV Couplers

Frequency (MHz)	Part Number	Impedance (ohms)	Coupling (dB)	Insertion Loss (dB)	Max. Power (W)	Return Loss (dB)	Package
5 - 120	MACPCT0017 ◆	75	17.3	—	1	26	SM-155
5 - 120	MACP-008249-CH09B0	75	17	—	0.25	26	SM-155
5 - 862	MACP-009821-CG0650	75	16	1.05	0.25	25	SM-101
5 - 870	MACP-008248-CH0670	75	17	0.7	1	22	SM-103-A
5 - 870	ELDC-10 ◆	75	10	1.0	0.25	18	SM-55
5 - 870	MACPCT0038	75	17	0.4	0.25	25	SM-103
5 - 870	MACPES0004 ◆	75	10	1.3	0.25	24	SM-132
5 - 1000	ELDC-14 ◆	75	14.3	1	0.25	23	SM-55
5 - 1000	ELDC-16 ◆	75	16	0.9	0.25	20	SM-55
5 - 1000	ELDC-12 ◆	75	12	1.2	0.25	21	SM-55
5 - 1000	ELDC-7 ◆	75	7	2.5	0.25	16	SM-55
5 - 1000	ELDC-8X1 ◆	75	8	2.1	0.25	22	SM-55
5 - 1000	EMDC-13-1-75 ◆	75	13	1.3	0.25	14	SM-22
5 - 1000	MACP-007486-CH0010	75	17	0.7	0.25	20	SM-1
5 - 1000	MACP-007490-CA0010	75	10.5	1.4	0.25	17	SM-1
5 - 1000	MACP-008125-CK07F0	75	20	0.4	0.25	27	SM-127
5 - 1000	MACP-008764-CH0370	75	17	0.6	0.25	25	SM-55
5 - 1000	MACP-008311-CE0370	75	14	1	0.25	23	SM-55
5 - 1000	MACP-009404-C80370	75	8	2.1	0.25	20	SM-55
5 - 1000	MACP-009736-CD0160	75	13	1.3	0.25	14	SM-22
5 - 1000	MACPCT0039	75	10	1.6	0.25	20	SM-138
5 - 1000	MACPES0050 ◆	75	20	1.2	0.25	20	SM-55
5 - 1000	MACP-009943-CH07F0	75	17	0.8	0.25	25	SM-55A
5 - 1200	MACP-009730-C60370	75	6	3.3	0.25	17	SM-55
5 - 1200	MACP-007727-CI07B0	75	18.7	1.4	0.25	23	SM-123
5 - 1200	MACPCT0030	75	16.8	1.2	0.25	28	SM-55
5 - 1200	MACPES0017	75	17.1	0.8	0.25		SM-103
5 - 1200	MACP-007741-CG09E0	75	17	1.5	0.25	15	SM-22
40 - 1000	MACPES0028 ◆	75	7	1.9	0.25	22	SM-137
40 - 1002	MACP-010718	75	17.3	0.6	0.25	24	SMT

Filters/Diplexers

Frequency (MHz)	Part Number	Impedance (ohms)	Passband (MHz)	Insertion Loss (dB)	Rejection (dB)	Rejection BW (dB)	Package
843 - 925	CDMA 900 ◆	50	27	0.5	105	0	Conn

Note: Part numbers are RoHS compliant ◆ indicates non-RoHS compliant

Blue listings indicate standard stock items widely available from our franchised distribution partners.

Detailed specifications for our standard parts can be found quickly on our website at [macomtech.com](http://macomtech.com) by typing the part number into the search box.

All specifications are subject to change.

**CATV Diplex Filters**

Frequency (MHz)	Part Number	Crossover Isol. (dB)	LP/HP Isol. (dB)	LP/HP RL (dB)	Common RL (dB)	Flatness (dB)	LP I.L. (dB)	HP I.L. (dB)	Package
5 - 30 / 46 - 870	MAFLCT0066	20	47/20/46	18/20	20	—	0.7	0.75	SM-160
5 - 30 / 46 - 1000	MAFL-007492-CD0A00	—	47/20/46	18/18	18	—	0.7	0.75	SMT
5 - 40 / 52 - 870	MAFLCT0031	—	55/55	22/20	22/20	—	0.5	0.5	SMT-142
5 - 40 / 52 - 870	MAFLES0122	41	50	22/22	22	0.85	1	1	Vertical plug-in
5 - 42 / 54 - 870	MAFLES0102	—	45/45	18/18	18	—	0.5	0.5	SM-149
5 - 42 / 54 - 1000	MAFL-007654-CD0A10	20	55/50	16	16	—	1.1	0.5	SM-161
5 - 42 / 54 - 1000	MAFL-009055-CD4254	16	55/50	16	16	—	0.5	0.5	SM-162
5 - 42 / 54 - 1000	MAFL-009810-CD0550	33	55/50	21/22	22	0.5	0.5	0.5	SM-85
5 - 42 / 54 - 1000	MAFL-011013	19	55/50	16/16	16	—	0.5	0.5	SMT
5 - 42 / 54 - 1100	MAFL-008098-CD0550	—	50/50	21/21	21	0.5	0.5	0.5	SM-85
5 - 65 / 94 - 860	MAFLCT0083	—	59/60/59	16/16	16	—	0.92	0.92	SM-161
5 - 65 / 88 - 1000	MAFLCT0027	—	—	20/20	20	—	0.5	0.5	SM-85
5 - 65 / 88 - 1000	MAFL-007988-CD0550	—	55/50	20	20	—	0.5	0.5	SM-85
5 - 1000	MAFLCT0027 ♦	75	—	20/20	20	—	0.5	0.5	SM-85

**CATV MoCA Filters**

Frequency (MHz)	Part Number	LP/HP Isolation (dB)	Common Return Loss (dB)	LP Insertion Loss (dB)	HP Insertion Loss (dB)	Package
5 - 42/54 - 1002/1125 - 1525	MAFL-009010-CT0B90	45/48	12	2.7	6	SMT
5 - 42 / 88 - 1002	MAFL-010464-CD0B20	-	15/12	1.2	1.2	SMT
5 - 42 / 88 - 1002	MAFL-010465-CD0B20	-	12/10	1.2	1.2	SMT
5 - 65 / 108 - 1002	MAFL-010467-CD0B20	-	13/10	1.5	0.8	SMT
5 - 42/54 - 1002/1125 - 1675	MAFL-011018	60/43/49	12/12/12	1.5	1.5/1.5/2.5	SMT
5 - 1002 / 1125 - 1550	MAFL-008290-CD0ACO	40/40	13/13	1.4	1.7	SM-172
50 - 870 / 975 - 1525	MAFL-007898-CD0ACO	40/42	15/14	1.8	1.2	SM-172
50 - 870 / 950 -1550	MAFL-008195-CD0ACO	39/37	14/12	1.5	2.0	SM-172
50 - 870/ 975 - 1525	MAFL-008070-CLOAD0	34/30	13	.75	1.8	SM-173
50 - 870 / 975 - 1025	MAFL-008571-CD0AFO	37/37	12	2.0	6	SM-175
870 - 925	MAFLCT0081	45/45	18	1.2	-	SM-171
975 - 1025	MAFL-008867-CB0B40	14/14	15	2	-	SM-180
1125 - 1175	MAFL-008868-CB0B50	14/14	15	2	-	SM-180
1125 - 1550	MAFL-010256-CB0ADO	40/35	13	1.7	-	SM-173
1300 - 1350	MAFL-008869-CB0B60	14/14	15	2	-	SM-180
1475 - 1525	MAFL-008870-CB0B70	14/14	15	2	-	SM-180

Note: Part numbers are RoHS compliant ♦ indicates non-RoHS compliant

Blue listings indicate standard stock items widely available from our franchised distribution partners.

Detailed specifications for our standard parts can be found quickly on our website at [macomtech.com](http://macomtech.com) by typing the part number into the search box.

All specifications are subject to change.



MACOM power detectors are broadband, directional detectors which have integrated low loss directional couplers and built-in temperature compensation circuits. These detectors provide an easy way to monitor the power of a signal travelling in a specific direction along a transmission line. These detectors are conveniently housed in miniature lead free plastic surface mount packages.

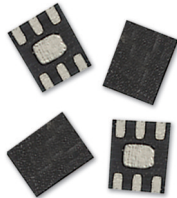

- Typical applications include:
- Power monitoring and leveling in point-to-point radios
  - IMS
  - Radar
  - VSAT
  - EW
  - Aerospace and defense systems

**Power Detectors**

Frequency (GHz)	Part Number	Insertion Loss (dB)	Power, Min Detectable (dBm)	Package
2 - 6	MACP-010561	0.15	-15	1.5 x 1.2 mm TDFN-6
6 - 18	MACP-010562	0.03	-17	1.5 x 1.2 mm TDFN-6
10 - 30	MACP-010563	0.05	-17	1.5 x 1.2 mm TDFN-6

Note: Part numbers are RoHS compliant ◆ indicates non-RoHS compliant  
 Blue listings indicate standard stock items widely available from our franchised distribution partners.  
 Detailed specifications for our standard parts can be found quickly on our website at [macomtech.com](http://macomtech.com) by typing the part number into the search box.  
 All specifications are subject to change.



MACOM IC-based switches are used extensively in commercial and military electronics applications. The switches range from DC to 20 GHz and are designed specifically for voice and data applications.

- Cordless and mobile phones
- Cellular base stations
- Satellite radio
- GPS & DAB
- 2.4 GHz and 5.0 GHz WLAN
- VSAT
- 75 ohm CATV and broadband
- Bluetooth
- RFID
- Fixed Wireless Access (FWA)
- Instrumentation
- Commercial and military radar
- Aerospace and defense products

MACOM diode-based HMIC™ silicon series-shunt PIN diode switches provide outstanding frequency performance from 50 MHz to 20 GHz. Our AlGaAs series-shunt PIN diode switches provide remarkable frequency performance from 50 MHz to 50 GHz.

- HMIC and AlGaAs switches are suitable for microwave and millimeter wave control circuits for military, instrumentation, and optoelectronic applications.
- HMIC switches: 0.9 dB loss and 42 dB isolation at 20 GHz
- AlGaAs switches: 0.7 dB loss and 35 dB isolation at 50 GHz

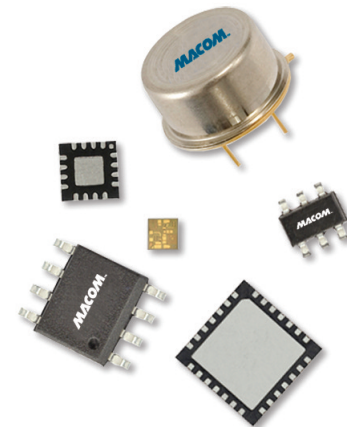

## General

Frequency (MHz)	Part Number	Type	Insertion Loss (dB)	Isolation (dB)	Input IP3 (dBm)	Package
<b>Die Products</b>						
0 - 2000	MASW2040	DPDT	0.4	20	46	Die
0 - 6000	MASW6030G	DPDT	0.6	40	45	Die
0 - 6000	MASW6020G	SPST	0.9	64	46	Die
50 - 20000	MA4SW110	SPST	0.7	42	50	Die

(continued on page 58)



## General (continued)

Frequency (MHz)	Part Number	Type	Insertion Loss (dB)	Isolation (dB)	Input IP3 (dBm)	Package
<b>Die Products</b>						
50 - 20000	MASW-001100-1190	SPST	0.7	42	50	Die
50 - 50000	MA4AGSW1	SPST	0.3	46	40	Die
10000 - 50000	MA4AGSW1A	SPST	1.2	30	40	Die
0 - 3000	MASW2000	SPDT	0.6	35	53	Die
0 - 4000	MASW4030G	SPDT	0.8	50	46	Die
0 - 6000	MASW6010G	SPDT	0.5	45	46	Die
0 - 8000	MASW-009590-000DIE	SPDT	0.5	22	52	Die
0 - 20000	MASW20000	SPDT	1.7	50	43	Die
50 - 20000	MA4SW210	SPDT	0.7	42	50	Die
50 - 20000	MASW-002100-1191	SPDT	0.7	42	50	Die
50 - 26500	MASW-002102	SPDT	1.2	40	43	Die
50 - 50000	MA4AGSW2	SPDT	0.7	33	40	Die
2000 - 18000	MA4SW210B-1	SPDT	1.25	40	47	Die
2400 - 5800	MASW-008206-000DIE	SPDT	0.7	30	54	Die
50 - 20000	MA4SW310	SP3T	0.9	42	50	Die
50 - 20000	MASW-003100-1192	SP3T	0.9	42	50	Die
50 - 26500	MASW-003102	SP3T	1.3	40	43	Die
50 - 50000	MA4AGSW3	SP3T	0.8	31	40	Die
500 - 2500	MASWSS0100 ♦	SP3T	0.5	20	69	Die
1000 - 4000	MASW-009276-0001DIE	SP3T	0.51	24	55	Die
2000 - 18000	MA4SW310B-1	SP3T	1.25	40	47	Die
2400 - 2500	MASW-008902-000DIE	SP3T	0.6	31.5	55	Die
0 - 4000	MASW4060G	SP4T	1.3	50	46	Die
50 - 20000	MA4SW410	SP4T	0.9	34	50	Die
50 - 26500	MASW-004100-1193	SP4T	0.9	34	43	Die
50 - 26500	MASW-004102	SP4T	1.4	35	43	Die
50 - 50000	MA4AGSW4	SP4T	1	32	40	Die
2000 - 18000	MA4SW410B-1	SP4T	1.4	35	47	Die
50 - 20000	MA4SW510	SP5T	0.9	38	50	Die
50 - 26500	MASW-005100-1194	SP5T	0.9	38	43	Die
50 - 26500	MASW-005102	SP5T	1.8	35	43	Die
50 - 50000	MA4AGSW5	SP5T	1.9	30	40	Die
2000 - 18000	MA4SW510B-1	SP5T	1.8	35	47	Die
50 - 26500	MASW-006102	SP6T	1.2	40	43	Die
500 - 2500	MASWSS0091	SP6T	0.5	38	70	Die
2000 - 18000	MA4SW610B-1	SP6T	1.9	39	47	Die
50 - 40000	MA4AGSW8-1	SP8T	2	32	40	Die
50 - 40000	MA4AGSW8-2	SP8T	2	35	35	Die
1800 - 4000	MA4BN1840-1	Bias Network	0.15	35	—	Die
75000 - 100000	MASW-011029	SPDT	4	30	—	Die

Note: Part numbers are RoHS compliant ♦ indicates non-RoHS compliant

Blue listings indicate standard stock items widely available from our franchised distribution partners.

Detailed specifications for our standard parts can be found quickly on our website at [macomtech.com](http://macomtech.com) by typing the part number into the search box.

## General (continued)

Frequency (MHz)	Part Number	Type	Insertion Loss (dB)	Isolation (dB)	Input IP3 (dBm)	Package
<b>Packaged Products</b>						
<b>0 - 4000</b>	<b>MASWSS0184</b>	<b>DPDT</b>	<b>0.7</b>	<b>30</b>	<b>57.5</b>	<b>3 mm PQFN-12</b>
<b>0 - 4000</b>	<b>MASW-007587</b>	<b>DPDT</b>	<b>0.7</b>	<b>38</b>	<b>59</b>	<b>3 mm PQFN-12</b>
0 - 6000	MASWSS0107	DPDT	0.95	22	52	3 mm PQFN-12
<b>0 - 6000</b>	<b>MASWSS0129</b>	<b>DPDT</b>	<b>0.75</b>	<b>30</b>	<b>49</b>	<b>3 mm PQFN-12</b>
<b>500 - 3000</b>	<b>MASW-009460</b>	<b>DPDT</b>	<b>0.7</b>	<b>19</b>	<b>52</b>	<b>3 mm PQFN-12</b>
<b>500 - 3000</b>	<b>MASWSS0130</b>	<b>DPDT</b>	<b>0.6</b>	<b>25</b>	<b>55</b>	<b>3 mm PQFN-12</b>
<b>2000 - 6000</b>	<b>MASWSS0190</b>	<b>DPDT</b>	<b>0.75</b>	<b>43</b>	<b>50</b>	<b>2 mm UTDFN-8</b>
<b>4500 - 6000</b>	<b>MASWSS0175</b>	<b>DPDT</b>	<b>0.8</b>	<b>30</b>	<b>52</b>	<b>3 mm PQFN-12</b>
<b>0 - 2500</b>	<b>MASWSS0162</b>	<b>SPST</b>	<b>1</b>	<b>70</b>	<b>46</b>	<b>SOIC-8</b>
0 - 3000	SW-214	SPST	1.3	25	46	FP-13
<b>0 - 3000</b>	<b>SW-311</b>	<b>SPST</b>	<b>1.3</b>	<b>27</b>	<b>46</b>	<b>CR-9</b>
0 - 3000	SW05-0311	SPST	1.3	25	46	CR-9
0 - 4000	MASW-007070-000100	SPST	0.85	25	48	CSP-1
2 - 3000	MASW-001150-1356	SPST	0.6	33	—	Surface Mount
5 - 3000	SW-215 ♦	SPST	2.9	27	46	DI-1
5 - 3000	SW-216 ♦	SPST	2.9	27	46	DI-1
5 - 4000	SW-231 ♦	SPST	2.8	22	46	FP-16
10 - 1000	SW-121 ♦	SPST	1	40	30	DI-1
<b>300 - 4000</b>	<b>MASWSS0148</b>	<b>SPST</b>	<b>55</b>	<b>1.6</b>	<b>49</b>	<b>3 mm PQFN-12</b>
0 - 2000	SW-224	SPDT	0.8	30	46	TO-5-3
<b>0 - 2000</b>	<b>SW-225</b>	<b>SPDT</b>	<b>0.8</b>	<b>30</b>	<b>46</b>	<b>FP-13</b>
<b>0 - 2000</b>	<b>MASWSS0179</b>	<b>SPDT</b>	<b>0.5</b>	<b>20</b>	<b>45</b>	<b>SOT-26</b>
<b>0 - 2500</b>	<b>MASWSS0201</b>	<b>SPDT</b>	<b>1.1</b>	<b>46</b>	<b>45</b>	<b>3 mm PQFN-12</b>
<b>0 - 2500</b>	<b>MASWSS0157</b>	<b>SPDT</b>	<b>0.6</b>	<b>70</b>	<b>46</b>	<b>SOIC-8</b>
0 - 2500	MASWSS0161	SPDT	0.5	40	61	SOIC-8
<b>0 - 2500</b>	<b>MASWSS0180</b>	<b>SPDT</b>	<b>0.5</b>	<b>33</b>	<b>46</b>	<b>SOIC-8</b>
<b>0 - 3000</b>	<b>MASWSS0192</b>	<b>SPDT</b>	<b>0.18</b>	<b>30</b>	<b>53</b>	<b>SC-70 (SOT-363)</b>
<b>0 - 3000</b>	<b>MASWSS0115</b>	<b>SPDT</b>	<b>0.3</b>	<b>22</b>	<b>46</b>	<b>SC-70 (SOT-363)</b>
<b>0 - 3000</b>	<b>MASW-008075</b>	<b>SPDT</b>	<b>0.4</b>	<b>25</b>	<b>48</b>	<b>SC-70 (SOT-363)</b>
<b>0 - 3000</b>	<b>MASWSS0136</b>	<b>SPDT</b>	<b>27</b>	<b>0.4</b>	<b>51.5</b>	<b>SC-70 (SOT-363)</b>
<b>0 - 3000</b>	<b>MASWSS0176</b>	<b>SPDT</b>	<b>0.3</b>	<b>21</b>	<b>45</b>	<b>SOT-26</b>
<b>0 - 3000</b>	<b>MASWSS0181</b>	<b>SPDT</b>	<b>0.4</b>	<b>20</b>	<b>60</b>	<b>SOT-26</b>
0 - 3000	SW-110	SPDT	1.1	18	46	CR-9
0 - 3000	SW-312	SPDT	1.2	30	48	CR-9
<b>0 - 3000</b>	<b>SW-313</b>	<b>SPDT</b>	<b>1.2</b>	<b>35</b>	<b>46</b>	<b>CR-9</b>
<b>0 - 3000</b>	<b>MASWSS0143</b>	<b>SPDT</b>	<b>0.4</b>	<b>20</b>	<b>53</b>	<b>SOT-26</b>
<b>0 - 3000</b>	<b>MASWSS0166</b>	<b>SPDT</b>	<b>0.3</b>	<b>21</b>	<b>55</b>	<b>SC-70 (SOT-363)</b>
<b>0 - 3000</b>	<b>MASWSS0151</b>	<b>SPDT</b>	<b>0.7</b>	<b>25</b>	<b>55</b>	<b>SC-70 (SOT-363)</b>
<b>0 - 3000</b>	<b>MASWSS0169</b>	<b>SPDT</b>	<b>0.8</b>	<b>50</b>	<b>85</b>	<b>MSOP-10</b>
<b>0 - 3000</b>	<b>MASW-007935</b>	<b>SPDT</b>	<b>28</b>	<b>0.8</b>	<b>50</b>	<b>SOT-26</b>
<b>0 - 3000</b>	<b>MASW-007221</b>	<b>SPDT</b>	<b>0.3</b>	<b>22</b>	<b>52</b>	<b>SC-70 (SOT-363)</b>
<b>0 - 3000</b>	<b>MASW-008899</b>	<b>SPDT</b>	<b>0.4</b>	<b>27</b>	<b>48</b>	<b>SC-70 (SOT-363)</b>
0 - 3000	SW10-0312	SPDT	1.2	27	46	CR-9
0 - 3000	SW10-0313	SPDT	1.2	35	46	CR-9
0 - 3000	MASWSS0204	SPDT	0.3	25	56	SC-70 (SOT-363)
0 - 4000	SW-226	SPDT	1.5	25	46	CR-2

(continued on page 60)

Note: Part numbers are RoHS compliant ♦ indicates non-RoHS compliant

Blue listings indicate standard stock items widely available from our franchised distribution partners.

Detailed specifications for our standard parts can be found quickly on our website at [macomtech.com](http://macomtech.com) by typing the part number into the search box.

All specifications are subject to change.

## General (continued)

Frequency (MHz)	Part Number	Type	Insertion Loss (dB)	Isolation (dB)	Input IP3 (dBm)	Package
0 - 4000	SW-227	SPDT	1.4	35	46	CR-2
0 - 4000	SW-228	SPDT	1	22	46	CR-2
0 - 4000	MASW-007071-000100	SPDT	1.8	30	46	CSP-1
<b>0 - 5000</b>	<b>MASW-008853</b>	<b>SPDT</b>	<b>0.45</b>	<b>15</b>	<b>56</b>	<b>SC-70 (SOT-363)</b>
0 - 6000	MASWSS0202	SPDT	0.55	25	50	3 mm PQFN-12
<b>0 - 6000</b>	<b>MASW-009444</b>	<b>SPDT</b>	<b>0.3</b>	<b>23</b>	<b>47</b>	<b>1 mm PDFN-6</b>
0 - 6000	MASW-000822-12770T	SPDT	0.35	26	65	3 mm PQFN
0 - 6000	MASWSS0200	SPDT	0.55	24	52	3 mm PQFN-12
<b>0 - 6000</b>	<b>MASW-007107</b>	<b>SPDT</b>	<b>0.75</b>	<b>20</b>	<b>50</b>	<b>2 mm PQFN-8</b>
<b>0 - 6000</b>	<b>MASWSS0093</b>	<b>SPDT</b>	<b>0.85</b>	<b>28</b>	<b>53</b>	<b>3 mm PQFN-12</b>
<b>0 - 6000</b>	<b>MASW-007588</b>	<b>SPDT</b>	<b>0.85</b>	<b>30</b>	<b>53</b>	<b>3 mm PQFN-12</b>
<b>0 - 7000</b>	<b>MASW-007921</b>	<b>SPDT</b>	<b>0.6</b>	<b>25</b>	<b>59</b>	<b>2 mm PQFN-8</b>
0 - 20000	MASW-008322	SPDT	1.9	40	48	4 mm PQFN-24
5 - 2000	SW-233 ♦	SPDT	1.5	40	46	FP-16
5 - 2000	SW-236 ♦	SPDT	1.5	40	46	FP-16
5 - 3000	SW-205 ♦	SPDT	2.6	35	46	DI-1
5 - 3000	SW-206 ♦	SPDT	2.6	35	46	DI-1
5 - 3000	SW-207 ♦	SPDT	2.3	18	46	DI-1
10 - 3000	SW-137	SPDT	1.6	32	46	DI-1
10 - 4000	MASW-008543	SPDT	0.7	65	53	MSOP-8-EP
10 - 4000	MASW-000932-13500T	SPDT	0.3	43	72	4 mm PQFN-16
10 - 6000	MASW-000825-12770T	SPDT	0.29	28.6	64	3 mm PQFN-16
10 - 6000	MASW-000834-13560T	SPDT	0.3	41.8	65	4 mm PQFN-16
20 - 1500	SW-162 ♦	SPDT	1.5	40	25	DI-1
20 - 2000	SW-112 ♦	SPDT	2.2	50	30	DI-1
50 - 6000	MASW-000936-14000T	SPDT	0.3	45	72	4 mm PQFN-16
<b>500 - 3000</b>	<b>MASWSS0167</b>	<b>SPDT</b>	<b>25</b>	<b>0.3</b>	<b>48</b>	<b>1.2x1.5 mm PQF- 6</b>
<b>500 - 3000</b>	<b>MASWSS0178</b>	<b>SPDT</b>	<b>0.7</b>	<b>50</b>	<b>43</b>	<b>MSOP-8-EP</b>
<b>500 - 3000</b>	<b>MASWSS0121</b>	<b>SPDT</b>	<b>0.6</b>	<b>54</b>	<b>43</b>	<b>4 mm PQFN-16</b>
0 - 2500	MASWSS0199	SP3T	0.5	20	59	3 mm PQFN-12
<b>0 - 3000</b>	<b>MASWSS0144</b>	<b>SP3T</b>	<b>24</b>	<b>0.6</b>	<b>55</b>	<b>3 mm PQFN-12</b>
<b>0 - 3000</b>	<b>MASW-008330</b>	<b>SP3T</b>	<b>0.3</b>	<b>24</b>	<b>50</b>	<b>2 mm PQFN-8</b>
<b>0 - 3500</b>	<b>MASW-008955</b>	<b>SP3T</b>	<b>0.55</b>	<b>22</b>	<b>54</b>	<b>2 mm PDFN-8</b>
0 - 3500	MASW-010612	SP3T	0.6	21	54	1.5 mm PDFN-8
<b>0 - 4000</b>	<b>MASW-009359</b>	<b>SP3T</b>	<b>0.55</b>	<b>27</b>	<b>65</b>	<b>2 mm STQFN-12</b>
5 - 2000	SW-241 ♦	SP3T	2.5	35	46	DI-5
20 - 1500	SW-163 ♦	SP3T	2	35	25	DI-2
<b>500 - 3000</b>	<b>MASWSS0191</b>	<b>SP3T</b>	<b>0.5</b>	<b>30</b>	<b>58</b>	<b>2 mm STDFN</b>
0 - 2000	SW-415	SP4T	1.8	37	46	FP-25
<b>0 - 3000</b>	<b>MASW-007813</b>	<b>SP4T</b>	<b>0.8</b>	<b>27</b>	<b>58</b>	<b>3 mm PQFN-16</b>
0 - 3000	MASW-008566	SP4T	0.65	23	57	4 mm PQFN-16
<b>0 - 3000</b>	<b>SW-314</b>	<b>SP4T</b>	<b>1.8</b>	<b>30</b>	<b>46</b>	<b>CR-14</b>
0 - 3000	SW15-0314	SP4T	1.8	25	46	CR-14
0 - 4000	MASWCC0010	SP4T	2.3	38	40	CSP-2
5 - 2000	SW-255 ♦	SP4T	2.1	35	68	DI-5
5 - 2000	SW-261 ♦	SP4T	2.1	35	46	FP-17

Note: Part numbers are RoHS compliant ♦ indicates non-RoHS compliant

Blue listings indicate standard stock items widely available from our franchised distribution partners.

Detailed specifications for our standard parts can be found quickly on our website at [macomtech.com](http://macomtech.com) by typing the part number into the search box.

All specifications are subject to change.

## General (continued)

Frequency (MHz)	Part Number	Type	Insertion Loss (dB)	Isolation (dB)	Input IP3 (dBm)	Package
<b>Packaged Products</b>						
10 - 1000	SW-124 ◆	SP4T	1.4	40	30	DI-2
10 - 2000	SW-114 ◆	SP4T	2.8	35	30	DI-2
20 - 1500	SW-164 ◆	SP4T	2	35	25	DI-2
20 - 2000	SW-369 ◆	SP4T	2.8	40	44	FP-26
0 - 2000	SW-284	SP6T	2.8	28	46	FP-27
0 - 4000	MASWCC0006	SP6T	2.1	25	40	CSP-2
<b>500 - 2500</b>	<b>MASW-000105</b>	<b>SP6T</b>	<b>0.5</b>	<b>41</b>	<b>60</b>	<b>4 mm PQFN-20</b>
0 - 3000	SW-283	Transfer	2.1	20	50	CR-4

## CATV Switches

Frequency (MHz)	Part Number	Type	Insertion Loss (dB)	Isolation (dB)	Input IP3 (dBm)	Package
5 - 1000	MASW-008177 ◆	SPST	0.65	54	52	3 mm FQFN-12
<b>5 - 1000</b>	<b>MASWSS0103 ◆</b>	<b>SPDT</b>	<b>1</b>	<b>63</b>	<b>52</b>	<b>4 mm FQFN-20</b>
5 - 1000	MASW-008153	SPDT	1	60	52	4 mm FQFN-20
5 - 1000	MASW-009101	SPDT	1	55	50	3 mm FQFN-12
5 - 3000	MASW-008801	SPDT	1	52	47	4 mm FQFP-N-20

## Switches with Drivers

Frequency (MHz)	Part Number	Type	Insertion Loss (dB)	Isolation (dB)	Switching Speed (ns)	Input IP3 (dBm)	Package
10 - 3000	MASW-007076-000100	SPST	2.2	35	50	46	SOW-24
10 - 500	S10 ◆	SPST	2	55	5	25	TO-8
<b>10 - 500</b>	<b>S11 ◆</b>	<b>SPST</b>	<b>2</b>	<b>55</b>	<b>2</b>	<b>25</b>	<b>TO-8</b>
0 - 3000	SW-313	SPDT	1.2	35	18	46	CR-9
0 - 3000	MASW-007075-000100	SPDT	2.2	33	50	46	SOW-24
0 - 3000	MASW-007074-000100	SP3T	2.3	30	50	46	SOW-24
0 - 3000	SW-314	SP4T	1.8	30	25	46	CR-14
0 - 3000	MASW-007073-000100	SP4T	2.3	25	50	46	SOW-24
0 - 3000	MASWCC0009	SP4T	2.5	25	50	46	QSOP-24
10 - 4000	MASW-010350	SP4T	0.8	55	20	50	4 mm PQFN-24
10 - 4000	MASW-010351	SP5T	1	54	20	50	4 mm PQFN-24

## Switch Limiters

Frequency (MHz)	Part Number	Type	Insertion Loss (dB)	Isolation (dB)	Switching Speed (ns)	Peak Power (dBm)	Package
2700 - 3500	MASL-011023	SPST	1	31	700	51	SOW-24

Note: Part numbers are RoHS compliant ◆ indicates non-RoHS compliant

Blue listings indicate standard stock items widely available from our franchised distribution partners.

Detailed specifications for our standard parts can be found quickly on our website at [macomtech.com](http://macomtech.com) by typing the part number into the search box.

All specifications are subject to change.

# Transistors

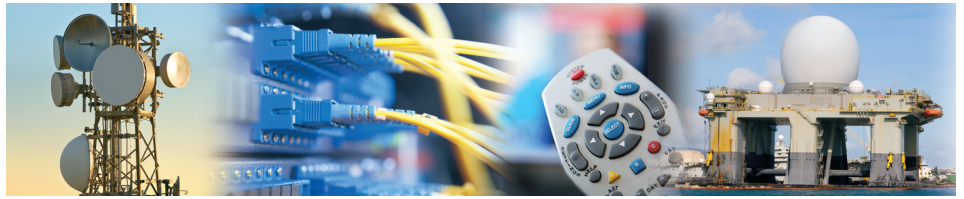

MACOM manufactures a broad range of RF power solutions using a variety of transistor technologies for commercial and military applications.

- Avionics
  - Broadcast
  - Communications
  - Industrial, scientific and medical
  - Radar
- 
- Discrete devices
  - Pallets
  - Modules

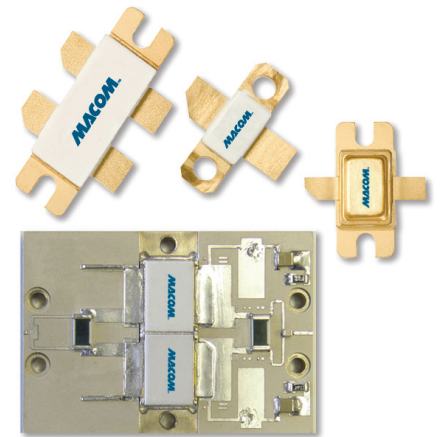

## Communications, Broadcast and Industrial, Scientific and Medical

Frequency (MHz)	Part Number	Description	Operating Voltage (V)	Output Power (W)	Min. Gain (dB)	Efficiency (%)	Pulse Condition
2 - 30	MRF448	Bipolar	50	250	12	45	CW
2 - 30	MRF429	Bipolar	50	150	13	45	CW
2 - 30	MRF422	Bipolar	28	150	10	40	CW
2 - 30	MRF421	Bipolar	12.5	100	10	40	CW
2 - 30	MRF454	Bipolar	12.5	80	12	50	CW
2 - 30	MRF455	Bipolar	12.5	60	13	55	CW
2 - 30	MRF426	Bipolar	28	25	22	35	CW
2 - 80	MRF157	MOSFET	50	600	15	40	CW
2 - 100	MRF154	MOSFET	50	600	15	40	CW
2 - 128	MAPF250128-150000	MOSFET	100	150	19	40	CW
2 - 150	MRF140	MOSFET	28	150	14	35	CW
2 - 150	MRF150	MOSFET	50	150	17	45	CW
2 - 175	MRF141G	MOSFET	28	300	12	45	CW
2 - 175	MRF141	MOSFET	28	150	16	40	CW
2 - 175	MRF173	MOSFET	28	80	11	55	CW
2 - 175	MRF173CQ	MOSFET	28	80	11	55	CW
2 - 175	MRF151G	MOSFET	50	300	14	50	CW
2 - 175	MRF151	MOSFET	50	150	18	40	CW
2 - 175	MRF148A	MOSFET	50	30	18	40	CW
2 - 200	MRF174	MOSFET	28	125	9	50	CW
2 - 400	MRF313	Bipolar	38	1	15	40	CW
2 - 400	MRF175LU	MOSFET	28	100	8	50	CW
2 - 400	MRF177	MOSFET	28	100	10	55	CW
2 - 400	MRF136Y	MOSFET	28	30	12	50	CW
2 - 400	MRF137	MOSFET	28	30	13	50	CW
2 - 400	MRF136	MOSFET	28	15	13	50	CW
2 - 400	MRF134	MOSFET	28	5	11	50	CW
2 - 500	MRF176GV	MOSFET	50	200	15	50	CW
2 - 500	MRF175GV	MOSFET	28	200	14	65	CW
2 - 500	MRF175GU	MOSFET	28	150	12	50	CW
2 - 500	MRF275L	MOSFET	28	100	7.5	50	CW
2 - 500	MRF158	MOSFET	28	2	16	50	CW
30 - 175	DU28200M	MOSFET	28	200	13	55	CW
30 - 175	DU28120T	MOSFET	28	120	13	60	CW
30 - 175	DU28120V	MOSFET	28	120	13	60	CW
30 - 175	DU2880T	MOSFET	28	80	13	60	CW
30 - 175	DU2880U	MOSFET	28	80	13	60	CW
30 - 175	DU2880V	MOSFET	28	80	13	60	CW
30 - 175	DU2860U	MOSFET	28	60	13	60	CW
30 - 175	DU2860T	MOSFET	28	60	13	60	CW
30 - 175	DU1260T	MOSFET	12	60	8	60	CW
30 - 175	DU2840S	MOSFET	28	40	13	60	CW
30 - 175	DU1230S	MOSFET	12	30	10	60	CW
30 - 175	DU2820S	MOSFET	28	20	13	60	CW
30 - 175	DU1215S	MOSFET	12	15	9.5	60	CW

Note: Part numbers are RoHS compliant ♦ indicates non-RoHS compliant

Blue listings indicate standard stock items widely available from our franchised distribution partners.

Detailed specifications for our standard parts can be found quickly on our website at [macomtech.com](http://macomtech.com) by typing the part number into the search box. All specifications are subject to change.



## Communications, Broadcast and Industrial, Scientific and Medical (continued)

Frequency (MHz)	Part Number	Description	Operating Voltage (V)	Output Power (W)	Min. Gain (dB)	Efficiency (%)	Pulse Condition
30 - 175	DU2810S	MOSFET	28	10	13	55	CW
30 - 175	DU2805S	MOSFET	28	5	11	55	CW
30 - 200	MRF317	Bipolar	28	100	9	55	CW
30 - 200	MRF316	Bipolar	28	80	10	55	CW
30 - 200	MRF314	Bipolar	28	30	10	50	CW
30 - 200	MRF171A	MOSFET	28	45	15	55	CW
30 - 500	MRF392	Bipolar	28	125	8	50	CW
30 - 500	MRF393	Bipolar	28	100	7.5	50	CW
30 - 500	MRF166W	MOSFET	28	40	14	50	CW
30 - 500	MRF166C	MOSFET	28	20	13.5	50	CW
30 - 500	MRF160	MOSFET	28	4	15	50	CW
100 - 500	MRF327	Bipolar	28	80	7.3	50	CW
100 - 500	UF2805B	MOSFET	28	5	10	50	CW
100 - 500	UF28100H	MOSFET	28	100	10	50	CW
100 - 500	UF28100M	MOSFET	28	100	10	50	CW
100 - 500	UF28100V	MOSFET	28	100	10	50	CW
100 - 500	UF2810P	MOSFET	28	10	10	50	CW
100 - 500	UF28150J	MOSFET	28	150	8	55	CW
100 - 500	UF2815B	MOSFET	28	15	10	50	CW
100 - 500	UF2820P	MOSFET	28	20	10	50	CW
100 - 500	UF2840G	MOSFET	28	40	10	50	CW
100 - 500	UF2840P	MOSFET	28	40	10	50	CW
100 - 500	MRF275G	MOSFET	28	150	10	50	CW
200 - 500	MRF321	Bipolar	28	10	12	50	CW
200 - 500	MRF323	Bipolar	28	20	10	50	CW
225 - 400	2N6439	Bipolar	28	60	7.8	55	CW
500 - 1000	LF2802A	MOSFET	28	2	10	40	CW
500 - 1000	LF2805A	MOSFET	28	5	10	50	CW
500 - 1000	LF2810A	MOSFET	28	10	10	50	CW
1600 - 1640	MRF16030	Bipolar	28	30	7.5	40	CW
1600 - 1640	MRF16006	Bipolar	28	6	7.4	40	CW

Note: Part numbers are RoHS compliant ◆ indicates non-RoHS compliant

Blue listings indicate standard stock items widely available from our franchised distribution partners.

Detailed specifications for our standard parts can be found quickly on our website at [macomtech.com](http://macomtech.com) by typing the part number into the search box.

All specifications are subject to change.

## Avionics: TACAN, TCAS, IFF, Mode S, DME, JTIDS

Frequency (MHz)	Part Number	Description	Operating Voltage (V)	Output Power (W)	Min. Gain (dB)	Efficiency (%)	Pulse Condition
960 - 1215	MAPR-000912-700S00	Bipolar	50	700	9.5	45	10 μs, 10%
960 - 1215	MAPR-000912-500S00*	Bipolar	50	500	9	45	10 μs, 10%*
960 - 1215	MAPRST0912-350**	Bipolar	50	350	9.4	45	10 μs, 10%**
960 - 1215	MRF1150MB	Bipolar	50	150	7.8	35	10 μs, 1%
960 - 1215	MRF1090MB	Bipolar	50	90	8.4	35	10 μs, 1%
960 - 1215	MAPRST0912-50	Bipolar	50	50	6.8	40	10 μs, 10%
960 - 1215	MRF10120	Bipolar	36	120	7.6	40	7 μs at 54% for 3.4 mS
960 - 1215	MRF10031	Bipolar	36	30	9	40	10 μs at 50% for 3.5mS
960 - 1215	MRF10005	Bipolar	28	5	8.5	45	CW
960 - 1215	MRF1004MB	Bipolar	35	4	10	40	10 μs, 1%
960 - 1215	MRF1000MB	Bipolar	18	0.2	10	-	CW
1025 - 1150	MAPR-001011-850S00	Bipolar	50	850	7.8	42	10 μs, 1%
1025 - 1150	MRF10502	Bipolar	50	500	8.5	40	32 μs, 2%
1025 - 1150	MRF10350	Bipolar	50	350	8.5	40	MODE S, 128 μs, burst on, 0.5 off, 6.4 mS
1025 - 1150	MAPR-001090-350S00	Bipolar	50	350	9	45	10 μs, 10%
1025 - 1150	MRF10150	Bipolar	50	150	9.5	40	10 μs, 10%
1030	MAPRST1030-1KS	Bipolar	50	1000	8	45	10 μs, 1%
1030 - 1090	PH1090-700B***	Bipolar	50	700	7.5	50	32 μs, 2%***
1030 - 1090	PH1090-550S	Bipolar	50	550	7.4	55	10 μs, 1%
1030 - 1090	PH1090-350L	Bipolar	45	350	8	55	250 μs, 10%
1030 - 1090	PH1090-175L	Bipolar	45	175	8.3	55	250 μs, 10%
1030 - 1090	MAPR-001090-165S00	Bipolar	50	165	9.6	50	10 μs, 10%
1030 - 1090	PH1090-75L	Bipolar	45	75	9	45	250 μs, 10%
1030 - 1090	PH1090-15L	Bipolar	45	15	9	40	250 μs, 10%

\* For JTIDS requirements, de-rate to 180 W, 36 V to 38 V,

\*\* For JTIDS, requirements, de-rate to 30 W, 36 V to 38 V,

\*\*\* For Mode-S ELM, de-rate to 450 W, 45 V

Note: Part numbers are RoHS compliant ◆ indicates non-RoHS compliant

Blue listings indicate standard stock items widely available from our franchised distribution partners.

Detailed specifications for our standard parts can be found quickly on our website at [macomtech.com](http://macomtech.com) by typing the part number into the search box.

All specifications are subject to change.

## Broadband Modules and Pallets

Frequency (MHz)	Part Number	Description	Operating Voltage (V)	Output Power (W)	Min. Gain (dB)	Efficiency (%)	Pulse Condition
30 - 88	MAPM-003088-010C12 ◆	VHF Power Module	28	10	25	—	CW
30 - 88	MAPM-003088-020C12 ◆	VHF Power Module	28	20	25	—	CW
30 - 400	MAPM-030400-010C00 ◆	Broadband Module	28	10	25	—	CW
30 - 400	MAPM-030400-060C00 ◆	Broadband Module	28	60	9	35	CW
30 - 400	MAPP-030400-100C2X ◆	Broadband Module	28	2 x 100	10	—	CW
20 - 512	MAPM-020512-010C00 ◆	Communications Module	28	10	20	—	CW
20 - 512	MAPM-020512-040C00 ◆	Communications Module	28	40	10	37	CW
20 - 512	MAPM-020512-060C00 ◆	Communications Module	28	60	10	—	CW
20 - 512	MAPM-020512-010C12 ◆	Broadband Power Module	12	10	25	30	CW
20 - 512	MAPM-020512-100C28 ◆	Broadband Power Module	32	100	12	30	CW
30 - 400	PHA4000-1 ◆	Broadband VHF/UHF Module	27	13	28	25	CW
30 - 400	PHA4000-2 ◆	Broadband VHF/UHF Module	27	64	7	35	CW
2700 - 2900	PHA2729-240M ◆	Pulsed Power Pallet	36	240	7.4	39	100 $\mu$ s, 10%
2700 - 2900	MAPP-002729-300M00 ◆	Pulsed Power Pallet	38	300	8.3	40	100 $\mu$ s, 10%
2700 - 3100	MAPP-002731-250M00 ◆	Pulsed Power Pallet	36	250	7.5	40	200 $\mu$ s, 10%
2700 - 3100	PHA2731-140L ◆	Pulsed Power Pallet	36	140	7	35	300 $\mu$ s, 10%
2900 - 3300	MAPPST2933-190M ◆	Pulsed Power Pallet	36	190	7	35	200 $\mu$ s, Pulse, 10%
3100 - 3400	MAPP-003134-150L00 ◆	Pulsed Power Pallet	36	150	8	36	300 $\mu$ s, 10%
3100 - 3400	MAPP-003134-180M00 ◆	Pulsed Power Pallet	36	180	7.5	35	150 $\mu$ s, Pulse, 10%
3100 - 3400	MAPP-003134-150L00 ◆	Pulsed Power Pallet	36	150	8.3	35	300 $\mu$ s, Pulse, 10%
3100 - 3500	PHA3135-130M ◆	Pulsed Power Pallet	36	130	7.4	35	100 $\mu$ s, 10%
3100 - 3500	MAPP-003134-130M2S ◆	Pulsed Power 2-Stage Amp	36	130	16	32	100 $\mu$ s, 10%

## Radar: L- and S-Band

Frequency (MHz)	Part Number	Description	Operating Voltage (V)	Output Power (W)	Min. Gain (dB)	Efficiency (%)	Pulse Condition
1100 - 1300	PHI1113-100	Bipolar	32	100	8	52	3 $\mu$ s, 30% duty
1200 - 1400	MAPR-001214-400M00	Bipolar	44	400	9	47	150 $\mu$ s, 10% duty
1200 - 1400	PHI214-300M	Bipolar	40	300	7.5	45	150 $\mu$ s, 10% duty
1200 - 1400	PHI214-220M	Bipolar	40	220	7.4	50	150 $\mu$ s, 10% duty
1200 - 1400	PHI214-110M	Bipolar	40	110	7.4	50	150 $\mu$ s, 10% duty
1200 - 1400	PHI214-80M	Bipolar	40	80	7.5	50	150 $\mu$ s, 10% duty
1200 - 1400	MAPRST0002	Bipolar	40	50	9.5	50	150 $\mu$ s, 10% duty
1200 - 1400	PHI214-40M	Bipolar	40	40	8.5	50	150 $\mu$ s, 10% duty
1200 - 1400	MAPRST1214-150UF	Bipolar	36	150	7.4	45	6 ms, 25% duty
1200 - 1400	MAPRST1214-30UF	Bipolar	36	30	7.5	45	6 ms, 25% duty
1200 - 1400	MAPRST1214-6UF	Bipolar	36	6	8.8	40	6 ms, 25% duty
1200 - 1400	PHI214-100EL	Bipolar	28	100	6	52	2 ms, 20% duty
1200 - 1400	PHI214-55EL	Bipolar	28	55	6.6	50	1ms, 10% duty
1200 - 1400	PHI214-30EL	Bipolar	28	30	7.8	50	1 ms, 10% duty

Note: Part numbers are RoHS compliant ◆ indicates non-RoHS compliant

Blue listings indicate standard stock items widely available from our franchised distribution partners.

Detailed specifications for our standard parts can be found quickly on our website at [macomtech.com](http://macomtech.com) by typing the part number into the search box.

All specifications are subject to change.

## Radar: L- and S-Band (continued)

Frequency (MHz)	Part Number	Description	Operating Voltage (V)	Output Power (W)	Min. Gain (dB)	Efficiency (%)	Pulse Condition
1200 - 1400	PH1214-25L	Bipolar	28	25	9.5	50	300 $\mu$ s, 10% duty
1200 - 1400	PH1214-25M	Bipolar	28	25	9.5	50	150 $\mu$ s, 10% duty
1200 - 1400	PH1214-25S	Bipolar	28	25	9.5	50	1 $\mu$ s, 10% duty
1200 - 1400	PH1214-20EL	Bipolar	28	20	9.5	50	2 ms, 10% duty
1200 - 1400	PH1214-12M	Bipolar	28	12	9	45	150 $\mu$ s, 10% duty
1200 - 1400	PH1214-6M	Bipolar	28	6	7	45	100 $\mu$ s, 10% duty
1200 - 1400	PH1214-2M	Bipolar	28	2	7	40	100 $\mu$ s, 10% duty
1200 - 1400	PH1214-3L	Bipolar	16.5	3	5.7	40	2ms, 20% duty
1200 - 1400	PH1214-0.85L	Bipolar	11.5	0.85	9.3	30	2ms, 20% duty
2200 - 2600	PH2226-110M	Bipolar	36	110	8	45	100 $\mu$ s, 10% duty
2200 - 2600	PH2226-50M	Bipolar	36	50	8	45	100 $\mu$ s, 10% duty
2700 - 2900	MAPR-002729-170M00	Bipolar	36	170	8.5	40	100 $\mu$ s, 10% duty
2700 - 2900	PH2729-130M	Bipolar	36	130	7	40	100 $\mu$ s, 10% duty
2700 - 2900	PH2729-110M	Bipolar	36	110	6.8	35	100 $\mu$ s, 10% duty
2700 - 2900	PH2729-65M	Bipolar	36	65	8.5	40	100 $\mu$ s, 10% duty
2700 - 2900	PH2729-25M	Bipolar	36	25	9.2	45	100 $\mu$ s, 10% duty
2700 - 2900	PH2729-8.5M	Bipolar	36	8.5	8.1	35	100 $\mu$ s, 10% duty
2700 - 3100	PH2731-75L	Bipolar	36	75	7	38	300 $\mu$ s, 10% duty
2700 - 3100	PH2731-20M	Bipolar	36	20	8.2	45	100 $\mu$ s, 10% duty
2700 - 3100	PH2731-5M	Bipolar	36	5	7	30	100 $\mu$ s, 10% duty
3100 - 3400	PH3134-75S	Bipolar	36	75	7.5	35	1 $\mu$ s, 10% duty
3100 - 3400	PH3134-65M	Bipolar	36	65	7.5	35	100 $\mu$ s, 10% duty
3100 - 3400	PH3134-55L	Bipolar	36	55	7.5	35	300 $\mu$ s, 10% duty
3100 - 3400	PH3134-30S	Bipolar	36	30	7.5	35	1 $\mu$ s, 10% duty
3100 - 3400	PH3134-25M	Bipolar	36	25	7.5	35	100 $\mu$ s, 10% duty
3100 - 3400	PH3134-20L	Bipolar	36	20	7.5	35	300 $\mu$ s, 10% duty
3100 - 3400	PH3134-11S	Bipolar	36	11	8	35	1 $\mu$ s, 10% duty
3100 - 3400	PH3134-10M	Bipolar	36	10	8	35	100 $\mu$ s, 10% duty
3100 - 3400	PH3134-9L	Bipolar	36	9	8	35	300 $\mu$ s, 10% duty
3100 - 3500	PH3135-90S	Bipolar	36	90	7.5	35	2 $\mu$ s, 10% duty
3100 - 3500	PH3135-65M	Bipolar	36	65	7.5	35	100 $\mu$ s, 10% duty
3100 - 3500	PH3135-25S	Bipolar	36	25	7.5	35	2 $\mu$ s, 10% duty
3100 - 3500	PH3135-20M	Bipolar	36	20	7.5	35	100 $\mu$ s, 10% duty
3100 - 3500	PH3135-5M	Bipolar	33	5	8.5	30	100 $\mu$ s, 10% duty
3100 - 3500	PH3135-5S	Bipolar	33	5	8.5	30	2 $\mu$ s, 10% duty

Note: Part numbers are RoHS compliant ◆ indicates non-RoHS compliant

Blue listings indicate standard stock items widely available from our franchised distribution partners.

Detailed specifications for our standard parts can be found quickly on our website at [macomtech.com](http://macomtech.com) by typing the part number into the search box.

All specifications are subject to change.

MACOM continues to develop industry-leading gallium nitride (GaN) RF power products. Our product portfolio leverages MACOM's more than 60-year heritage of providing best-in-class standard, application specific and custom solutions for our radar, EW and communications customers.

MACOM GaN products are offered as un-matched transistors, internally matched power transistors, and fully matched power pallets and modules. Using a high performance 0.5um GaN HEMT process and leveraging our proprietary die layout and assembly techniques, these products exhibit robust thermal properties and excellent RF performance with respect to power, gain, gain-flatness, efficiency and ruggedness for applications up to 3.5 GHz.

MACOM's high power GaN in space saving plastic is setting the standard for applications where small size and low weight are required. 3 x 6 mm DFN packaged transistors are available in 15 W, 50 W, and 90 W power levels. These DFN transistors are also offered in fully matched, high gain, power modules which provide highly integrated, compact solutions.

## GaN on SiC

Frequency (MHz)	Part Number	Description	Operating Voltage (V)	Output Power (W)	Min. Gain (dB)	Efficiency (%)	Pulse Condition
30 - 3500	MAGX-000035-010000	GaN on SiC	50	10	19	45	500 µs Pulse, 10% Duty Cycle
30 - 3500	MAGX-000035-01000S	GaN on SiC	50	10	19	45	500 µs Pulse, 10% Duty Cycle
DC - 3500	MAGX-000035-01500P	GaN on SiC	50	15	19.5	65	1 ms Pulse, 10% Duty Cycle
DC - 3500	MAGX-000035-05000P	GaN on SiC	50	50	18	66	1 ms Pulse, 10% Duty Cycle
DC - 3500	MAGX-000035-09000P	GaN on SiC	50	90	17.5	65	100 µs Pulse, 10% Duty Cycle
30 - 3500	MAGX-000035-030000	GaN on SiC	50	25	18	60	300 µs Pulse, 10% Duty Cycle
960 - 1215	MAGX-000912-125L00	GaN on SiC	50	125	20	60	128 µs Pulse, 10% Duty Cycle
960 - 1215	MAGX-000912-250L00	GaN on SiC	50	250	19	60	128 µs Pulse, 10% Duty Cycle
1200 - 1400	MAGX-001214-125L00	GaN on SiC	50	125	19	60	300 µs Pulse, 10% Duty Cycle
1200 - 1400	MAGX-001214-250L00	GaN on SiC	50	250	19	58	300 µs Pulse, 10% Duty Cycle
1200 - 1400	MAGX-001214-500L00	GaN on SiC	50	500	19.2	55	300 µs Pulse, 10% Duty Cycle
1200 - 2000	MAGX-001220-100L00	GaN on SiC	50	100	14	55	300 µs Pulse, 10% Duty Cycle
2700 - 3100	MAGX-002731-030L00	GaN on SiC	50	30	11	55	500 µs Pulse, 10% Duty Cycle
2700 - 3100	MAGX-002731-100L00	GaN on SiC	50	100	12	50	500 µs Pulse, 10% Duty Cycle
2700 - 3100	MAGX-002731-180L00	GaN on SiC	50	180	11	48	300 µs Pulse, 10% Duty Cycle

**GaN test fixtures** are available on a limited basis.

Contact your local sales representative to learn more or request a sample or test fixture.

## MAGX-001214-500L00: 1.2-1.4 GHz Transistor

### Features

- Pout: 500 Watts
- Pulse/Duty: 300  $\mu$ s/10%
- Power Gain: 19.5 dB

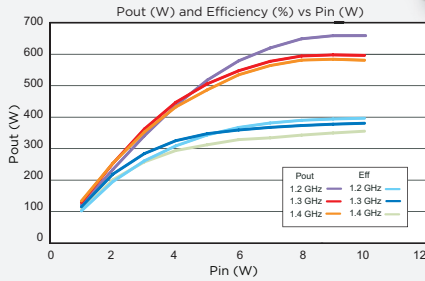

## MAGX-001090-700L00: 1.03-1.09 GHz Transistor

### Features

- Pout: 700 Watts
- Pulse/Duty: 300  $\mu$ s/10%
- Power Gain: 20 dB

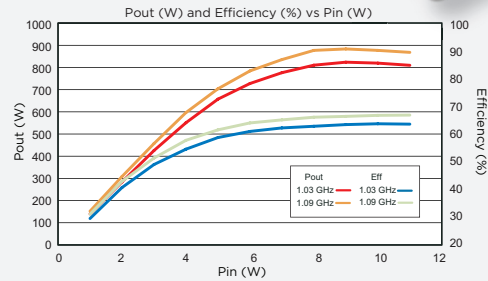

## MAGX-000035-01500P: 1.6 GHz Transistor

### Features

- SMT QFN Packaging
- Pout: 15 W Peak
- Power Gain: 19 dB
- Unmatched

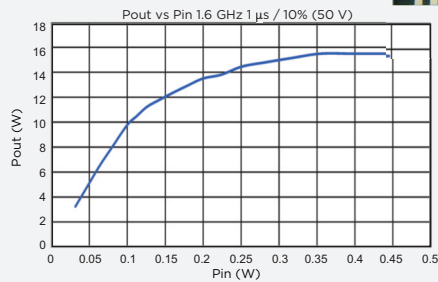
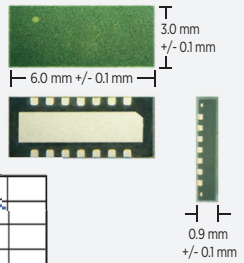

## MAGX-000035-05000P: 1.6 GHz Transistor

### Features

- SMT QFN Packaging
- Pout: 50 W Peak
- Power Gain: 18 dB
- Unmatched

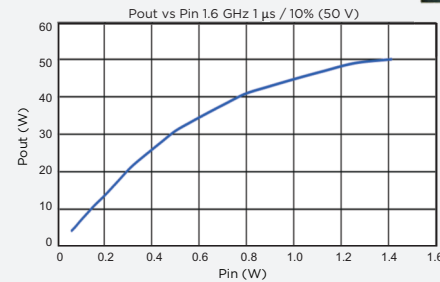
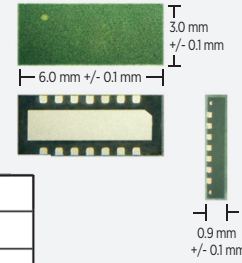

## MAGX-000035-09000P: 1.6 GHz Transistor

### Features

- SMT QFN Packaging
- Pout: 90 W Peak
- Power Gain: 17 dB
- Unmatched

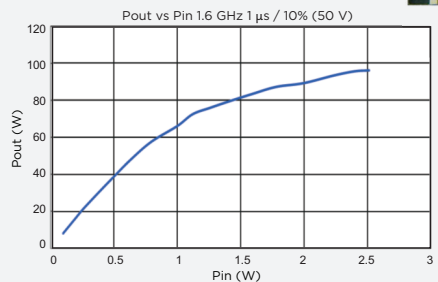
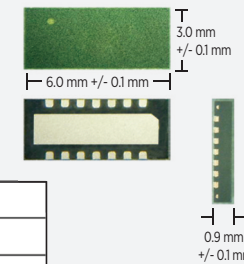

## MAMG-001214-090PSM

### Features

- Pout: 90 Watts
- Pulse/Duty: 300  $\mu$ s/10%
- Power Gain: 32 dB

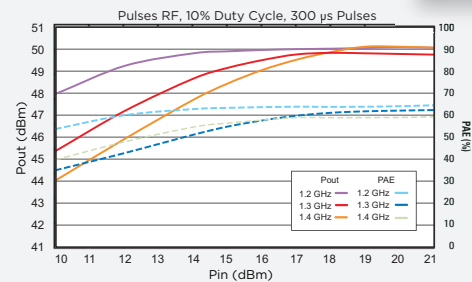





Macom's high power L-band GaN transistors allow customers to realize higher gain and higher efficiency solutions with extremely rugged and reliable performance.

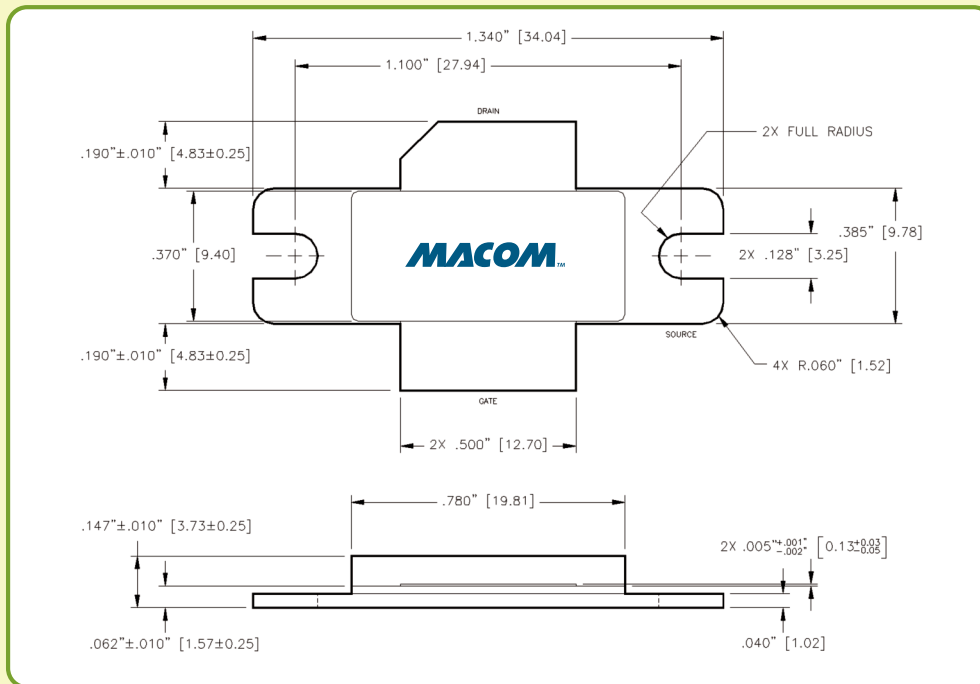

Detailed specifications for our standard parts can be found quickly on our website at [macomtech.com](http://macomtech.com) by typing the part number into the search box. All specifications are subject to change.

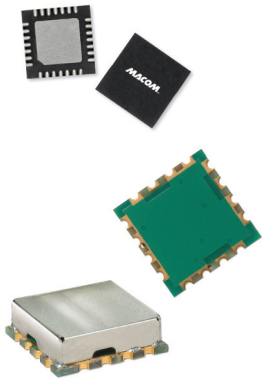
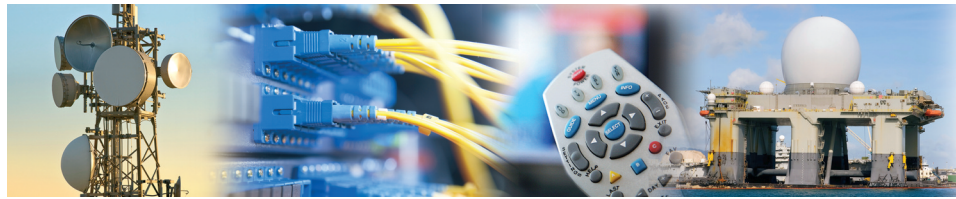

MACOM high frequency Voltage Controlled Oscillators (VCOs) are intended for the stringent phase noise requirements of high data rate point-to-point radio applications. These InGaP HBT based VCOs do not require any external matching components. They are easily integrated into a phase lock loop using the divide-by-two output.

- Low power consumption
- Bandwidths greater than 10%
- RoHs compliant package with lead-free finish
- Compatible with a 260°C reflow temperature
- Low lead inductance package and excellent thermal path

We also offer a variety of VCOs for other wireless communications, CATV and broadband, private and land mobile radio, and long range radio modems

## Voltage Controlled Oscillators (VCOs)

Frequency (GHz)	Part Number	DC Current (mA)	Pout at Fo (dBm)	Pout at Fo/2 (dBm)	Phase Noise at 100 kHz Offset (Vt=5V)(dBc/Hz)	Tuning Voltage (Volts)	Package
<b>Packaged Products</b>							
5.7 - 6.4	MAOC-009259	185	12	2	-117	1-13	5 mm PQFN-32
6.1 - 7.0	MAOC-009260	185	12	4.5	-117	1-13	5 mm PQFN-32
7.1 - 7.9	MAOC-009261	175	12	2	-116	1-13	5 mm PQFN-32
7.4 - 8.2	MAOC-009262	175	11	1	-115	1-13	5 mm PQFN-32
7.8 - 8.7	MAOC-009263	175	11	3.5	-115	1-13	5 mm PQFN-32
8.4 - 9.25	MAOC-010334	168	10	3	-115	2-13	5 mm PQFN-32
8.8 - 9.8	MAOC-009264	190	10.5	1.5	-114	1-13	5 mm PQFN-32
9.2 - 10.2	MAOC-009871	185	7	6	-113	2-13	5 mm PQFN-32
9.4 - 10.8	MAOC-009265	175	6	2.5	-110	1-13	5 mm PQFN-32
10.2 - 11.3	MAOC-009266	185	9	5	-114	1-13	5 mm PQFN-32
11.0 - 11.8	MAOC-009872	165	7	5	-112	2-13	5 mm PQFN-32
11.2 - 12.6	MAOC-009267	165	3.5	3	-110	1-13	5 mm PQFN-32
12.7 - 14.2	MAOC-009268	175	7	1.5	-108	1-13	5 mm PQFN-32
11.4 - 12.8	MAOC-009269	165	3	2	-110	1-13	5 mm PQFN-32
12.2 - 13.8	MAOC-009270	155	6.5	2.5	-105	1-13	5 mm PQFN-32

## VCOs

Frequency (MHz)	Part Number	Power Output Max (dBm)	Tune Voltage Min-Max (V)	Phase Noise (dBc/Hz) SSB @ Offset Freq (Max)		Tuning Sensitivity Typ (MHz/V)	Power Supply Current Max (mA)
				10 kHz	100 kHz		
42.5 - 47.5	MAVC-010000-000046	6	0.5 - 4.5	-118	-138	2.8	25
77.5 - 82.5	MAVC-010000-000080	6	0.5 - 4.5	-115	-135	2.5	25
80 - 81	MAVC-010000-000081	2	0.6 - 2.4	—	-130	3.25	—
119 - 125	MAVC-010000-000122	10	0.5 - 4.5	-87	-110	18	—
137 - 143	MAVC-010000-000140	2	0.5 - 4.5	—	-127	5	15
179 - 256	MAVC-010000-000217	3	0.5 - 4.5	-100	-121	26	15
380 - 450	MAVC-010000-000415	2	0.2 - 4.8	-105	—	23	14
405 - 440	MAVC-010000-000425	3	0.5 - 4.5	-105	-127	10	2
450 - 533	MAVC-010000-000492	2	0.2 - 4.8	-102	—	22	14
485 - 520	MAVC-010000-000505	3	0.5 - 4.5	-115	-135	12	15
470 - 554	MAVC-010000-000512	3	1 - 10	-108	-128	10	25
532 - 595	MAVC-010000-000564	3	0.2 - 4.8	-100	—	23	14
550 - 580	MAVC-010000-000565	3	0.5 - 4.5	-110	-130	10	20
583.6 - 628.6	MAVC-010000-000606	3	0.5 - 4.5	-113	—	—	20
554 - 704	MAVC-010000-000629	3	1 - 10	-105	-125	16.5	25
704 - 806	MAVC-010000-000755	3	1 - 10	-107	-127	11.3	25
751 - 786	MAVC-010000-000768	5	1 - 4	—	-122	20	20
793 - 828	MAVC-010000-000810	5	1 - 4	—	-129	25	20
777.8 - 880	MAVC-010000-000829	0	0.5 - 4.5	-103	—	35	7
886 - 906	MAVC-010000-000896	3	0.5 - 4.5	-113	-133	10	20
880 - 960	MAVC-010000-000920	0	0.5 - 4.5	-104	—	30	7
925 - 960	MAVC-010000-000942	3	0.5 - 4.5	-110	-150	20	11
1015 - 1051	MAVC-010000-001033	3	0.5 - 2.5	-100	-120	20	10
1070 - 1115	MAVC-010000-001093	3	0.4 - 4.5	-100	-122	17	15
1270 - 1315	MAVC-010000-001293	3	0.5 - 11	-110	-130	20	—
1265 - 1325	MAVC-010000-001295	3	0.5 - 4.5	-105	-125	19	—
1260 - 1350	MAVC-010000-001305	8	1 - 12	-103	-125	11	40
1300 - 1350	MAVC-010000-001325	5	0.5 - 4.5	-99	-121	21	—
1000 - 1650	MAVC-010000-001326	7.5	0.5 - 8	—	—	110	20
1350 - 1450	MAVC-010000-001400	3	0.5 - 11	-104	-124	20	—
1450 - 1580	MAVC-010000-001515	3	0.5 - 11	-105	-125	17	30
1440 - 1620	MAVC-010000-001530	3	0.5 - 4.5	—	-115	—	20
1544 - 1585	MAVC-010000-001564	8	1 - 12	-80	-105	6	40
1610 - 1640	MAVC-010000-001625	3	0.5 - 11	-100	-107	20	50
1600 - 1700	MAVC-010000-001650	2	0.5 - 4.5	—	-118	40	15
1600 - 1780	MAVC-010000-001690	3	0.5 - 4.5	-95	-115	60	30
1640 - 1740	MAVC-010000-001691	3	0.5 - 11	-105	—	17	50
1700 - 1800	MAVC-010000-001750	3	0.5 - 4.5	—	-115	40	15
1725 - 1880	MAVC-010000-001802	3	0.5 - 11	-96	-118	20	—
1805 - 1880	MAVC-010000-001842	5	0.5 - 4.5	—	-120	30	30
1780 - 1950	MAVC-010000-001865	3	0.5 - 11	-100	-120	20	—
1850 - 1910	MAVC-010000-001880	3	0.5 - 4.5	-93	-114	44	15
1844 - 2042	MAVC-010000-001943	8	1 - 10	-90	-110	30	40
1930 - 1900	MAVC-010000-001960	3	0.5 - 4.5	—	-115	31	15
1875 - 2055	MAVC-010000-001965	3	0.5 - 11	-96	-118	20	—

Note: Part numbers are RoHS compliant ♦ indicates non-RoHS compliant

Blue listings indicate standard stock items widely available from our franchised distribution partners.

Detailed specifications for our standard parts can be found quickly on our website at [macomtech.com](http://macomtech.com) by typing the part number into the search box.

All specifications are subject to change.

## VCOs (continued)

Frequency (MHz)	Part Number	Power Output Max (dBm)	Tune Voltage Min-Max (V)	Phase Noise (dBc/Hz) SSB @ Offset Freq (Max)		Tuning Sensitivity Typ (MHz/V)	Power Supply Current Max (mA)
				10 kHz	100 kHz		
1970 - 2130	MAVC-010000-002040	3	0.5 - 11	-100	-118	20	—
2023 - 2073	MAVC-010000-002048	—	0.5 - 5	-107	-128	21	45
2000 - 2150	MAVC-010000-002075	8	1 - 10	-93	-113	25	30
2000 - 2200	MAVC-010000-002100	3	0.5 - 4.5	-95	—	—	30
2112 - 2112	MAVC-010000-002112	6	0.5 - 4.5	-107	-127	20	45
2110 - 2170	MAVC-010000-002140	4	1 - 4	-95	-117	30	20
2100 - 2400	MAVC-010000-002250	9	0.5 - 12	-90	-110	42.5	45
2200 - 2400	MAVC-010000-002300	7	1 - 18	-98	-118	15	47
2304 - 2304	MAVC-010000-002304	6	0.5 - 4.5	-102	-122	20	45
2295 - 2325	MAVC-010000-002310	8	1 - 4	-95	-120	14	40
2275 - 2425	MAVC-010000-002350	3	0.5 - 11	-96	—	20	—
2200 - 2700	MAVC-010000-002450	7.5	1 - 18	-94	-115	30	50
2496 - 2690	MAVC-010000-002593	5	1 - 18	-98	-120	16	47
2650 - 2750	MAVC-010000-002700	5	1 - 19	-96	-116	17.5	35
2650 - 2800	MAVC-010000-002725	8	1 - 10	-92	-112	27	—
2748 - 2986	MAVC-010000-002850	8	1 - 12	-88	-110	30	40
2800 - 3100	MAVC-010000-002950	8.5	0.5 - 12	-90	-110	38	40
3110 - 3305	MAVC-010000-003208	8	1 - 10	-88	-110	30	40
3400 - 3600	MAVC-010000-003500	7	1 - 18	-96	-116	16	47
3660 - 3960	MAVC-010000-003810	5	1 - 19	-93	-113	38	35
3960 - 4160	MAVC-010000-004060	5	1 - 19	-93	-113	32.5	35

### LSM1 Package Style

- Plating: Au, 0.05  $\mu\text{m}$  - 0.15  $\mu\text{m}$  over Ni barrier of 2.5  $\mu\text{m}$  - 5.0  $\mu\text{m}$
- Internal solder: Sn95.5/Ag4.0/Cu0.5, lead free
- Substrate: FR4
- Cover: mild steel
- Tolerance:  $\pm 0.2$  mm unless otherwise noted

Request custom VCOs through 3.6 GHz. Complete and submit the form found at:  
[macomtech.com/customvcos](http://macomtech.com/customvcos)



MACOM surface mount hybrid VCOs support applications from 45 MHz to 4 GHz. Whether in hand-held or vehicle-mounted radios, or base stations, our VCOs deliver leading edge solutions to challenging communications needs. In addition to these state-of-the-art VCOs, we also offer a broad range of hybrid frequency synthesizers, modules, MMIC VCOs, diodes, transistors, and passive products—a comprehensive solutions set for communications applications.

Our VCOs feature:

- Low phase noise—Our specialty
- 100% factory tested
- Cost—Extremely competitive
- Custom designs—From your specifications

A selection of our latest design releases is shown below.

Frequency (MHz)	Part Number	Power Output (dBm)		Tune Voltage (V)		Phase Noise SSB (dBc/Hz) <sup>TM</sup>			Tuning Sensitivity (MHz/V)	Power Supply		Temp Range (C°)		VCO Type (Band)	Package Style
		Min	Max	Min	Max	Offset Freq	Typical	1 MHz		V <sub>cc</sub> (V) Nom	I <sub>c</sub> (mA) Max	Min	Max		
433 - 484	MAVC-010000-000458	3	7	0.5	10	-126	-134	-164	6	5	30	-30	85	Single	LSM1
490 - 580	MAVC-130000-000534	-4	0	2.5	10.5	-124	-133	-161	6	5	30	-30	85	Dual	LSM13
536 - 716	MAVC-110000-000626	0	3	0.5	11.5	-115	-124	-156	9.5	4.8	17	-30	85	Dual	LSM11
136 - 174	MAVC-150000-000155	6	10	2	14	-128	-136	-169	3.5	5	25	-40	85	Single	LSM15
200 - 239	MAVC-150000-000220	6	11	2	14	-125	-134	-169	3.5	5	25	-40	85	Single	LSM15
380 - 423	MAVC-150000-000402	1	6	2	12	-125	-134	-169	5	5	25	-30	70	Single	LSM15
423 - 466	MAVC-150000-000455	1	6	2	12	-125	-134	-166	5	5	25	-30	70	Single	LSM15
466 - 509	MAVC-150000-000488	1	6	2	12	-125	-134	-169	5	5	25	-30	70	Single	LSM15
762 - 806	MAVC-150000-000784	0	6	2	12	-125	-134	-164	5	5	25	-30	70	Single	LSM15
806 - 841	MAVC-150000-000824	0	6	2	12	-125	-134	-164	4	5	25	-30	70	Single	LMS15
841 - 871	MAVC-150000-000856	0	6	2	12	-125	-134	-164	3.5	5	25	-30	70	Single	LSM15
896 - 1076	MAVC-130000-000986	-4	2	2.5	10.5	-114	-124.5	-156	11	4.8	13	-40	85	Dual	LSM13
1399 - 1410	MAVC-170000-001404	-4.5	1.5	0.5	2.5	-102	-110	-142	12	2.5	10	-40	85	Single	LSM17
1445 - 1820	MAVC-110000-001632	-3	3	2	15	-112	-121	-155	17	5	30	-30	85	Single	LSM11
1516 - 2088	MAVC-110000-001802	-3	3	0.5	15	-109	-119	-151	22	4.8	20	-30	85	Dual	LSM11
1520 - 1720	MAVC-170000-001620	-5	3	0.7	4.3	-100	-108	-140	65	2.5	20	-25	70	Single	LSM17
1845 - 2045	MAVC-170000-001946	-5	3	0.7	4.4	-99	-108	-140	65	2.5	20	-25	70	Single	LSM17
2304	MAVC-140000-002304	4	9	0.5	5	-116	-126	-153	9	5	50	0	85	Single	LSM14

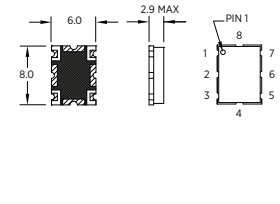
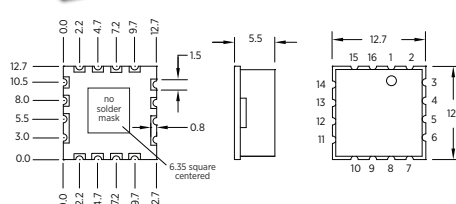
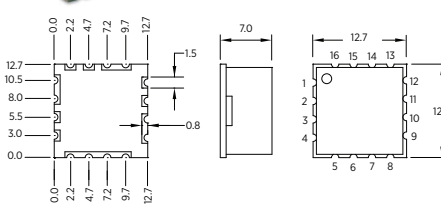
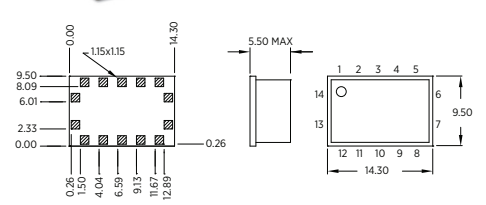
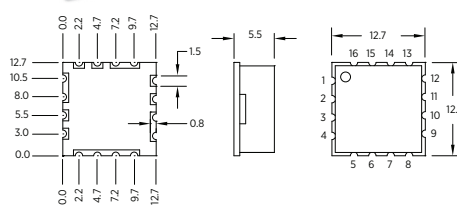
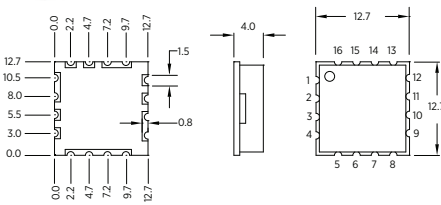



## Appendix and Part Number Index

Package Selection Guide

Decibels-Volts-Watts Conversion Table

Wavelength and Frequency

Telecommunications Standards

Part Number Index

Notes

## Plastic Leadless Packages

Package Type	Approx Outline Dimensions	
1 mm 6LD X1-DFN	1 x 1 x 0.45	
1.2 x 1.5 6LD PDFN (0.5 mm Pitch)	1.2 x 1.5 x 0.75	
1.5 x 1.2 6LD PDFN (0.4 mm Pitch)	1.5 x 1.2 x 0.75	
2 mm 8LD STDFN	2 x 2 x 0.55	
2 mm 12LD STQFN (0.5 mm Pitch)	2 x 2 x 0.55	
2 mm 12LD STQFN (0.4 mm Pitch)	2 x 2 x 0.55	
2 x 2.5 mm 14LD STQFN	2 x 2.5 x 0.55	
3 mm 12LD/16LD PQFN	3 x 3 x 0.9	
3 mm 12LD/16LD PQFN (LP)	3 x 3 x 0.75	
4 mm 16LD/20LD/24LD PQFN	4 x 4 x 0.9	
4 mm 16LD/20LD PQFN (LP)	4 x 4 x 0.75	
5 mm 20LD/28LD/32LD PQFN	5 x 5 x 0.9	
6 mm 28LD/40LD/48LD PQFN	6 x 6 x 0.9	
4 x 6 mm 32LD PQFN	4 x 6 x 0.9	
4 x 7 mm 36LD PQFN	4 x 7 x 0.9	

## Plastic Leaded Packages

SC-79	0.8 x 1.6 x 0.6	
SOD-323	1.3 x 2.5 x 1.1	
SOT-23	2.9 x 2.4 x 1	
SOT-25	2.9 x 2.8 x 1.3	
SOT-26	2.9 x 2.8 x 1.3	
SOT-89	4.5 x 4 x 1.5	
SOT-143	2.9 x 2.4 x 1	
SC70 3LD (SOT-323)	2 x 2.1 x 1	
SC70 6LD (SOT-363)	2 x 2.1 x 1	

## Plastic Leaded Packages (continued)

Package Type	Approx Outline Dimensions (mm)	
SOIC-8/SOIC-8EP	4.9 x 6 x 1.6	
SOIC-14	8.7 x 6 x 1.6	
SOIC-16	9.9 x 6 x 1.6	
SOW-16	10.3 x 10.3 x 2.5	
SOW-24	15.4 x 10.3 x 2.5	
TSSOP-16	5 x 6.4 x 1.1	
SSOP-20	7.2 x 7.8 x 1.9	
MSOP-8	3 x 4.9 x 1	
MSOP-8EP	3 x 4.9 x 1	
MSOP-10/MSOP-10EP	3 x 4.9 x 1	
QSOP-16	4.9 x 6 x 1.6	
QSOP-24	8.7 x 6 x 1.6	
QSOP-28	9.9 x 6 x 1.6	

## Plastic Ball Grid Arrays Packages (PBGA)\*

8 mm 64 I/O PBGA	8 x 8 x 1.7	
15 mm 90 I/O PBGA	15 x 15 x 3	

\*other package outlines available



## Ceramic/Chip Diode Packages

Package Type	Approx Outline Dimensions (mm)	
30 Ceramic	3.2 dia. x 5.7	
134 Die	0.4 x 0.4 x 0.2	
186 Ceramic	11.2 x 2.5 x 1.1	
401 Axial Lead	2.3 dia. x 55	
1027 Ceramic	8 dia. x 6.9	
1056 Ceramic	1.9 x 1.9 x 1	
1072 Ceramic	2.4 x 2.4 x 3.4	
1073 Ceramic	12.3 dia. x 10	
1038 Ceramic	8 dia. x 17	
1080 Ceramic	8 dia. x 22.2	
1082 Ceramic	8 dia. x 19.8	
1088 Ceramic	2.4 x 1.3 x 1	
1246 Surmount	1.2 x 0.5 x 0.2	

## Metal/Ceramic Packages

Package Type	Approx Outline Dimensions (mm)	
CR2-6LD	18.3 x 11.3 x 1.3	
CR2	18.3 x 17.1 x 1.3	
CR3	16.2 x 4.6 x 1.6	
CR4	12.4 x 12.4 x 1.6	
CR5	8.9 x 8.0 x 1.6	
CR6	11.4 x 8.9 x 1.6	
CR12	11.4 x 11.4 x 2.0	
CR13	16.5 x 11.4 x 2.0	
CR15	17.8 x 11.4 x 2	
CR16	9.8 x 8.3 x 1.5	
1000017733	23.5 x 13.8 x 2.8	

## Metal/Ceramic Packages

Package Type	Approx Outline Dimensions (mm)	
MOD2 (3/4 size)	20.3 x 15 x 6.6	
MOD3 (3/4 size)	20.3 x 15 x 4.8	
SMA-AMP (3/4 size)	23.4 x 27.9 x 13.3	
SMA-MXR (3/4 size)	22.9 x 22.9 x 14	
SMT-01	11.4 x 11.4 x 4.3	
SMT-02	10 x 13 x 4	
SMT-88	13.4 x 13.4 x 4.3	
SMT-88F	11.4 x 11.4 x 4.3	
TO-8-01	12.7 dia. x 11	
TO-8-02	12.7 dia. x 9.7	
TO-8-03	15.2 dia. x 9.7	

## Metal/Ceramic Packages

Package Type	Approx Outline Dimensions (mm)	
CSM	12.5 x 9.4 x 4.8	
FP	13 x 9.8 x 3.6	
MOD1	14.2 x 13.2 x 4.8	

## Passive Packages

Package Type	Approx Outline Dimensions (mm)	
SM-2	12.5 x 9.4 x 6.4	
SM-4	12.4 x 9.4 x 5.8	
SM-22	3.8 x 3.8 x 3.8	
SM-55	7.1 x 6.4 x 3.6	
SM-85 (3/4 size)	30 x 30 x 9	
SM-89	8 x 6.4 x 0.15	
SM-138	4.2 x 5.3 x 3.9	
SM-152	4.2 x 5.3 x 4.3	

## Transistor Packages

Package Type	Approx Outline Dimensions (mm)	
P-237 Ceramic	20 x 15 x 4	
P-238 Ceramic	34 x 19.6 x 4	
P-239 Ceramic	21 x 1 x 4	
355E-01, Style 1 Ceramic	23 x 21 x 5	
368-03, Style 2 Ceramic	38 x 50 x 9	
PH1214-M Series Ceramic	23 x 10 x 4.5	
P-8TF	20.8 x 6.4 x 3.5	

## Transistor Packages (continued)

Package Type	Approx Outline Dimensions (mm)	
P-51H	22.9 x 10.2 x 5.5	
P-94C	22.9 x 10.2 x 5.5	
P-94D	22.9 x 10.2 x 4.2	
P-94I	22.9 x 10.2 x 4.2	
P-154C	25.4 x 15.2 x 5.1	
Pallet (1/4 size)	50.8 x 35.8 x 7	
Pallet (1/4 size)	50.8 x 35.8 x 7	

# Decibels – Volts – Watts Conversion Table



50-ohm System Terminated											
dBm	V	P <sub>0</sub>	dBm	V	P <sub>0</sub>	dBm	mV	P <sub>0</sub>	dBm	QV	P <sub>0</sub>
53	100	200W									
50	70.7	100W	0	0.225	1 mW	-49	0.8		-97	3.2	
49	64	80W	-1	0.2	0.8 mW	-50	0.71	.01 QW	-98	2.9	
48	58	64W	-2	0.18	0.64 mW	-51	0.64		-99	2.51	
47	50	50W	-3	0.16	0.5 mW	-52	0.57		-100	2.25	0.1 pW
46	44.5	40W	-4	0.141	0.4 mW	-53	0.5		-101	2	
45	40	32W	-5	0.125	0.32 mW	-54	0.45		-102	1.8	
44	32.5	25W	-6	0.115	0.25 mW	-55	0.4		-103	1.6	
43	32	20W	-7	0.1	0.2 mW	-56	0.351		-104	1.41	
42	28	16W	-8	0.09	0.16 mW	-57	0.32		-105	1.27	
41	26.2	12.5W	-9	0.08	0.125 mW	-58	0.286		-106	1.18	
40	22.5	10W	-10	0.071	0.1 mW	-59	0.251				
39	20	8W	-11	0.064		-60	0.225	0.001 QW	dBm	nV	
38	18	6.4W	-12	0.058		-61	0.2		-107	1000	
37	16	5W	-13	0.05		-62	0.18		-108	900	
36	14.1	4W	-14	0.045		-63	0.16		-109	800	
35	12.5	3.2W	-15	0.04		-64	0.141		-110	710	0.01 pW
34	11.5	2.5W	-16	0.0355					-111	640	
33	10	2W				dBm	QV		-112	580	
32	9	1.6W	dBm	mV		-65	128		-113	500	
31	8	1.25W	-17	31.5		-66	115		-114	450	
30	7.1	1W	-18	28.5		-67	100		-115	400	
29	6.4	800 mW	-19	25.1		-68	90		-116	355	
28	5.8	640 mW	-20	22.5	.01 mW	-69	80		-117	825	
27	5	500 mW	-21	20		-70	71	0.1 nW	-118	285	
26	4.45	400 mW	-22	17.9		-71	65		-119	251	
25	4	320 mW	-23	15.9		-72	58		-120	225	0.001 pW
24	3.55	250 mW	-24	14.1		-73	50		-121	200	
23	3.2	200 mW	-25	12.8		-74	45		-122	180	
22	2.8	160 mW	-26	11.5		-75	40		-123	160	
21	2.52	125 mW	-27	10		-76	35		-124	141	
20	2.25	100 mW	-28	8.9		-77	32		-125	128	
19	2	80 mW	-29	8		-78	29		-126	117	
18	1.8	64 mW	-30	7.1	.001 mW	-79	25		-127	100	
17	1.6	50 mW	-31	6.25		-80	22.5	0.01 nW	-128	90	
16	1.41	40 mW	-32	5.8		-81	20		-129	80	0.1 fW
15	1.25	32 mW	-33	5		-82	18		-130	71	
14	1.15	25 mW	-34	4.5		-83	16		-131	61	
13	1	20 mW	-35	4		-84	11.1		-132	58	
12	0.9	16 mW	-36	3.5		-85	12.9		-133	50	
11	0.8	12.5 mW	-37	3.2		-86	11.5		-134	45	
10	0.71	10 mW	-38	2.85		-87	10		-135	40	
9	0.64	8 mW	-39	2.5		-88	9		-136	35	
8	0.58	6.4 mW	-40	2.25	1 QW	-89	8		-137	33	
7	0.5	5 mW	-41	2		-90	7.1	0.001 nW	-138	29	
6	0.445	4 mW	-42	1.8		-91	6.1		-139	25	
5	0.4	3.2 mW	-43	1.6		-92	5.75		-140	23	0.01 fW
4	0.355	2.5 mW	-44	1.4		-93	5				
3	0.32	2 mW	-45	1.25		-94	4.5				
2	0.28	1.6 mW	-46	1.18		-95	4				
1	0.252	1.25 mW	-47	1		-96	3.51				
			-48	0.9							

## Frequency Band Designations

Previous Frequency Designations	P	L	S	C	X	Ku	K	Ka					
Current Frequency Designations	C	D	E	F	G	H	I	J	K				
	0.5	1.0	2.0	3.0	4.0	6.0	8.0	10.0	12.4	18.0	20.0	26.5	40.0
	Frequency (GHz)												

## Wavelength and Frequency

For all forms of wave, the velocity, wavelength, and frequency are related such that

$$\lambda F \sqrt{\epsilon_r \mu_r} = c$$

- $\lambda$  = wavelength in meters (m)
- $F$  = frequency in hertz (Hz)
- $\epsilon_r$  = relative dielectric constant of propagation medium
- $c$  = velocity of light (300,000,000 m/s)
- $\mu_r$  = relative permeability of propagation medium

The dielectric ( $\epsilon$ ) is a property of the medium in which the wave propagates. The value of  $\epsilon$  is defined as 1.000 for a perfect vacuum, and very nearly 1.0 for dry air (typically 1.006). In most practical applications, the value of  $\epsilon$  in dry air is taken to be 1.000. For mediums other than air or vacuum, however, the velocity of propagation is slower, and the value of  $\epsilon$  relative to a vacuum is higher. Teflon®, for example, can be made with dielectric constant values ( $\epsilon$ ) from about 2 to 11.

## Frequency vs. Wavelength

Frequency	Wavelength
1 MHz	300 meters (m)
10 MHz	30 m
100 MHz	3 m
300 MHz	1 m–100 centimeters (cm)
1 GHz	30 cm
10 GHz	3 cm
100 GHz	3 millimeters (mm)
300 GHz	1 mm–10 <sup>-3</sup> m
3 x 10 <sup>14</sup>	1 micron–10 <sup>-6</sup> m

## Worldwide Wireless Telecommunications Standards

Standard	Designation	Transmit Frequency Range (MHz)		Generation
		Handset	Base Station	
AMPS		824 - 849	869 - 894	Analog
TDMA	Cellular	824 - 849	869 - 894	2G
	PCS	1850 - 1910	1930 - 1990	2G
GSM	400	450.4 - 457.6	460.4 - 467.6	2G
	400	478.8 - 486	488.8 - 496	2G
	850	824 - 849	869 - 894	2G
	900	880 - 915	925 - 960	2G
	1800	1710 - 1785	1805 - 1880	2G
	1900	1850 - 1910	1930 - 1990	2G
CDMAone	Cellular	824 - 849	869 - 894	2G
	PCS	1850 - 1910	1930 - 1990	2G
GPRS/EDGE	400	450.4 - 457.6	460.4 - 467.6	2.5G
	400	478.8 - 486	488.8 - 496	2.5G
	850	824 - 849	869 - 894	2.5G
	900	880 - 915	925 - 960	2.5G
	1800	1710 - 1785	1805 - 1880	2.5G
	1900	1850 - 1910	1930 - 1990	2.5G
CDMA2000 1x	450	452.5 - 457.475	462.5 - 467.475	3G
EV-DO/EV-DV	800	824 - 849	869 - 894	3G
	1700	1750 - 1780	1840 - 1870	3G
	1900	1850 - 1910	1930 - 1990	3G
	2100	1920 - 1980	2110 - 2170	3G
W-CDMA (UMTS)		1920 - 1980	2110 - 2170	3G
TD-SCDMA1		2010 - 2025	2010 - 2025	3G

<sup>1</sup> Several additional frequency ranges have been set aside for use at the operator's or granting authority's discretion

## Cordless Telephone/Wireless Data

Standard	Frequency (MHz)
CT2 Cordless	864 - 868
CT2+ Cordless	944 - 948
DECT Cordless	1880 - 1900
Bluetooth	2402 - 2495
IEEE 802.11a	5150 - 5350
IEEE 802.11b	2401 - 2483
IEEE 802.11g	2401 - 2483
ISM (US)	902 - 928
ISM (US)	2400 - 2500
ISM (US)	5725 - 5875

## Part Number 2020-6600-06 to CSFD25

Part Number	Page No.	Part Number	Page No.	Part Number	Page No.	Part Number	Page No.
2020-6600-06 ♦	52	A17	17	A67-1	17	AM42-0055	18
2020-6601-10 ♦	52	A18-1	17	A70	13	AM55-0004	14
2020-6602-20 ♦	52	A180	16	A70	15	AMS-162-PIN	13
2020-6603-30 ♦	52	A181	15	A70-1	13	AMS-162-PIN	15
2020-6604-06 ♦	52	A19-1	17	A70-1	15	AT-106	21
2020-6605-10 ♦	52	A21-1	17	A70-2	13	AT-107	21
2020-6606-20 ♦	52	A231	13	A70-2	15	<b>AT-213</b>	<b>20</b>
2020-6607-30 ♦	52	A231	15	A70-3	15	AT-232	20
2020-6608-06 ♦	53	A24	17	A71	13	AT-233	21
2020-6609-10 ♦	53	A25	17	A71	15	<b>AT-263</b>	<b>21</b>
2020-6610-20 ♦	53	A25-1	17	A72	16	AT-273	21
2020-6611-30 ♦	53	A26	17	A73	16	AT-283	21
2020-6612-06 ♦	53	A27	17	A74	16	AT-357 ♦	20
2020-6613-10 ♦	53	A28	17	A74-1	15	AT-358 ♦	21
2020-6614-20 ♦	53	A28-2	17	A74-2	16	AT15-0001	20
2020-6615-30 ♦	53	A29-1	18	A75	13	<b>AT20-0106</b>	<b>21</b>
2020-6616-06 ♦	53	A3010	18	A75	16	<b>AT20-0107</b>	<b>21</b>
2020-6617-10 ♦	53	A31-1	18	A75-2	15	AT20-0263	21
2020-6618-20 ♦	53	A32	14	A75-3	13	AT20-0273	21
2020-6619-30 ♦	53	A32	18	A75-3	16	CA67-1	17
2020-6620-06 ♦	53	A32-1	18	A76	16	CD-920-4 ♦	50
2020-6621-10 ♦	53	A33	18	A76-1	16	CDMA 900 ♦	54
2020-6622-20 ♦	53	A33-1	11	A77	16	CGB7001-BD-000V	11
2020-6623-30 ♦	53	A33-1	18	A77-1	17	CGB7001-SC-OGOT	11
2020-6624-06 ♦	53	A34	18	A78	16	CGB7003-BD-000V	11
2020-6625-10 ♦	53	A35	18	A79	16	CGB7003-SC-OGOT	11
2020-6626-20 ♦	53	A35-1	11	A80	13	CGB7004-BD-000V	11
2020-6627-30 ♦	53	A35-1	18	A80	17	CGB7004-SC-OGOT	11
2020-6628-06 ♦	53	A36	18	A80-1	13	CGB7005-BD-000V	11
2020-6629-10 ♦	53	A36-1	18	A80-1	15	CGB7005-SC-OGOT	11
2020-6630-20 ♦	53	A36-2	11	A81	15	CGB7006-BD-000V	11
2020-6631-30 ♦	53	A36-2	18	A81-1	15	CGB7006-SC-OGOT	11
2025Series ♦	52	A37	18	A81-2	17	CGB7007-BD-000V	11
2026-6001-10 ♦	52	A38	18	A81-3	17	CGB7007-SC-OGOT	11
2026-6003-20 ♦	52	A39	18	A82	15	CGB7008-BD-000V	11
2026-6004-10 ♦	53	A4011	14	A82-1	16	CGB7008-SC-OGOT	11
2026-6006-20 ♦	53	A4011	18	A83-1	15	CGB7009-BD-000V	11
2026-6007-10 ♦	52	A4012	18	A87	16	CGB7009-SC-OGOT	11
2026-6009-20 ♦	52	A411	16	A87-1	16	CGB7010-BD-000V	11
2026-6010-10 ♦	52	A43	11	A87-2	16	CGB7010-SC-OGOT	11
2026-6012-20 ♦	52	A45	18	A88	16	CGB7011-BD-000V	11
203XSeries ♦	52	A45-1	18	A89	17	CGB7011-SC-OGOT	11
2089 Series ♦	49	A5	16	AL7 *	33	CGB7012-BD-000V	11
2090 Series ♦	49	A5-5	16	AM-119-PIN	16	CGB7012-SC-OGOT	11
2090-6204-00 ♦	49	A5-6	17	AM-123-PIN	16	CGB7014-BD-000V	11
2090-6205-00 ♦	49	A511	16	AM-131-PIN	16	CGB7014-SC-OGOT	11
2090-6210-00 ♦	49	A513	16	AM-143-PIN	16	CGB7015-BD-000V	11
2690-1001 ♦	33	A514	16	AM-145-PIN	17	CGB7015-SC-OGOT	11
2690-1003 ♦	33	A515	16	AM-146-PIN	16	CGB7016-BD-000V	11
2690-1007 ♦	33	A53	16	AM-147-PIN	16	CGB7016-SC-OGOT	11
2690-1005 ♦	33	A531	13	AM-151-PIN	16	CGB7017-BD-000V	11
2690-1009 ♦	33	A531	16	AM-153-PIN	18	CGB7017-SC-OGOT	11
2690-1011 ♦	33	A54	16	AM-155-PIN	18	<b>CGB8001-SC-OGOT</b>	<b>13</b>
2690-1013 ♦	33	A55	16	AM-160-PIN	17	CH-130-4 ♦	50
2690-1014 ♦	33	A56	16	AM-162-PIN	13	CH-132 ♦	50
2690-1015 ♦	33	A57	16	AM-162-PIN	15	CH-134 ♦	51
<b>2N6439</b>	<b>64</b>	A58	16	AM-176-PIN	21	CH-137 ♦	50
A1	13	A59	16	AM-177-PIN	21	CH-138 ♦	51
A1	16	A59-1	17	AM-180-PIN	22	CH-140 ♦	51
A101	14	A6011	14	AM-182-PIN	21	CHS-134 ♦	51
A101	15	A6011	18	AM-183-PIN	21	CHS-137 ♦	50
A1021	17	A61	18	AM-184-PIN	22	CMM-9-BD-000V	11
A1031	17	A611	17	AM-191-PIN	21	CMM0014-BD-000V	11
A11	17	A63	17	AM05-0005	19	CMM0015-BD-000V	11
A11-2	17	A64	17	AM05-0006	19	CMM0016-BD-000V	11
A12	17	A66	17	AM40-0023	18	CMM1100-BD-000V	11
A1211	17	A66-1	17	AM42-0002	19	CMM4000-BD-000V	11
A1212	14	A66-3	17	AM42-0007	19	CMM6004-SC	12
A1212	17	A67	17	AM42-0054	18	CSFD25 ♦	31

Note: Part numbers are RoHS compliant ♦ indicates non-RoHS compliant  
 Blue listings indicate standard stock items widely available from our franchised distribution partners.



## Part Number CSFD25H to MA46H071 Series

Part Number	Page No.	Part Number	Page No.	Part Number	Page No.	Part Number	Page No.
CSFD25H ♦	31	ELCM-11X	37	FD26 ♦	31	M3H-50 ♦	47
CSFD26 ♦	31	ELCM-1H	36	FD26C ♦	31	M3V-50 ♦	49
CSM11-13	37	ELCM-1MH	36	FD26E ♦	31	M4A, SM4A ♦	37
CSM12-13 ♦	38	ELCM-2	36	FD93 ♦	31	M4B, SM4B ♦	37
CSM2-17	38	ELCM-5	37	FD93C ♦	31	M4G, SM4G ♦	38
CSM4T	36	ELDC-10 ♦	51	FD93H ♦	31	<b>M4T ♦, SM4T</b>	<b>36</b>
CSM4T17	36	ELDC-10 ♦	54	FD93HC ♦	31	<b>M4TH, SM4TH ♦</b>	<b>36</b>
CSM5T ♦	37	ELDC-12 ♦	54	FDZ5013 ♦	31	<b>M50, M50C ♦</b>	<b>39</b>
CSM5T17 ♦	37	ELDC-14 ♦	51	FDZ5013C ♦	31	M50A, M50AC ♦	38
CSM5TH	37	ELDC-14 ♦	54	FM-104 ♦	31	M51, M51C ♦	39
DCG-10-4 ♦	52	ELDC-16 ♦	51	FM-105 ♦	31	M52, M52C ♦	39
DM1-18A ♦	38	ELDC-16 ♦	54	FM-106 ♦	31	M53, M53C ♦	39
<b>DS-109 ♦</b>	<b>48</b>	ELDC-20 ♦	51	FMS-109 ♦	31	M5T ♦	37
DS-112 ♦	48	ELDC-7 ♦	54	G1	20	M63, M63C ♦	39
DS-113 ♦	47	ELDC-7 ♦	51	G2	20	M63H, M63HC ♦	39
DS-117 ♦	47	ELDC-8X1 ♦	51	G30	20	M67, M67C ♦	39
DS-309 ♦	48	ELDC-8X1 ♦	54	G40	20	M6D-50 ♦	36
DS-310 ♦	47	ELPD-20-1 ♦	50	GS-4-7TR ♦	47	M6E-50v	36
DS-312 ♦	48	<b>ELPD-20-1 ♦</b>	<b>48</b>	H-1-4 ♦	51	M6EHv	36
<b>DS-313 ♦</b>	<b>48</b>	ELPD-290 ♦	49	H-183-4 ♦	52	M6R ♦	37
DS-318 ♦	48	EMD-10-1	51	H-8-4 ♦	47	M6V, SM6V ♦	36
<b>DS-319 ♦</b>	<b>48</b>	EMD40-900L	37	H-81-4 ♦	48	M74, M74C ♦	39
<b>DS-323 ♦</b>	<b>49</b>	<b>EMDC-10-1-75 ♦</b>	<b>51</b>	H-9 ♦	50	M76, M76C ♦	39
DS-324 ♦	49	EMDC-13-1-75 ♦	51	HH-105 ♦	52	M76H, M76HC ♦	39
<b>DS-327 ♦</b>	<b>48</b>	EMDC-13-1-75 ♦	54	HH-106 ♦	50	M77, M77C ♦	39
DS-328 ♦	47	EMDC-13-2	51	HH-107 ♦	50	M79, M79C ♦	39
DS-331 ♦	49	EMDC-16-1	51	HH-108 ♦	50	M79H, M79HC ♦	39
DS-332 ♦	49	EMDC-16-2-75 ♦	52	HH-109 ♦	50	M80, M80C ♦	39
DS-4-4 ♦	47	EMDC-17-1-75 ♦	51	HH-110 ♦	51	M83, M83C ♦	38
<b>DS-409-4 ♦</b>	<b>49</b>	EMDC-17-5-75 ♦	51	HH-127 ♦	51	M85, M85C ♦	38
DS-808-4 ♦	49	EMDC-17-8-75 ♦	51	HH-128 ♦	52	M86, M86C ♦	39
DSS-113 ♦	47	EMDC-20-1	52	HHS-109 ♦	50	M87, M87C ♦	37
<b>DSS-313 ♦</b>	<b>48</b>	EMRS-1	36	HHS-110 ♦	51	M88, M88C ♦	38
DSS-327 ♦	48	EMRS-11F	37	JH-10-4 ♦	52	M88H, M88HC ♦	38
DSS-333 ♦	48	EMRS-2	36	JH-113 ♦	51	M89, M89C ♦	38
<b>DU1215S</b>	<b>63</b>	EMRS-5MH	37	JH-114 ♦	52	M8H-3, M8HC-3 ♦	39
<b>DU1230S</b>	<b>63</b>	ESMD-C1	36	JH-115 ♦	52	M8H-7, M8HC-7 ♦	39
<b>DU1260T</b>	<b>63</b>	<b>ESMD-C15</b>	<b>37</b>	JH-119 ♦	52	<b>M8T, M8TC ♦</b>	<b>36</b>
<b>DU2805S</b>	<b>64</b>	<b>ESMD-C50H</b>	<b>37</b>	JH-121 ♦	52	M8TH, M8THC ♦	36
<b>DU2810S</b>	<b>64</b>	<b>ESMD-C50L</b>	<b>37</b>	JH-131 ♦	52	M93, M93C ♦	38
<b>DU28120T</b>	<b>63</b>	<b>ESMD-C50M</b>	<b>37</b>	JH-133 ♦	52	M9BC ♦	36
<b>DU28120V</b>	<b>63</b>	ESML-2-1 ♦	48	JH-136 ♦	52	M9E ♦	36
<b>DU28200M</b>	<b>63</b>	ESML-2-4 ♦	48	<b>JH-139 ♦</b>	<b>52</b>	M9H, M9HC ♦	37
<b>DU2820S</b>	<b>63</b>	ESSM-2-2-75 ♦	48	<b>JH-140 ♦</b>	<b>52</b>	MA144769,	
<b>DU2840S</b>	<b>63</b>	<b>ESSM-2-8-75</b>	<b>48</b>	JH-141 ♦	52	MAVR-044769 Series	23
<b>DU2860T</b>	<b>63</b>	ESSM-2-9-75 ♦	48	JHS-113 ♦	51	MA40045-137	24
<b>DU2860U</b>	<b>63</b>	ESSM-2-9-75 ♦	50	JHS-114 ♦	52	MA40045-137	24
<b>DU2880T</b>	<b>63</b>	ESSMJ-2-12-75 ♦	50	JHS-115 ♦	52	MA40115-276	24
<b>DU2880U</b>	<b>63</b>	<b>ESSMJ-2-12-75 ♦</b>	<b>48</b>	JHS-119 ♦	52	MA40126-186	24
EA1	16	ETC1-1-10	45	JHS-121 ♦	52	MA40143-213	24
EA2	16	ETC1-1-10TR	45	JHS-136 ♦	52	MA40147-213	24
EA53-2	16	<b>ETC1-1-13</b>	<b>43</b>	JHS-139 ♦	52	MA40201-119	24
EA54	15	ETC1-1-6	45	JHS-142 ♦	52	MA40205-119	24
EA54-2	16	ETC1-1-6TR	45	<b>L1</b>	<b>33</b>	MA40215-120	24
EIN10 ♦	47	<b>ETC1-1T-2TR</b>	<b>43</b>	L42	33	MA40261	24
EIN11 ♦	47	ETC1.5-7	43	<b>LA17</b>	<b>33</b>	MA40264	24
EIN12 ♦	47	ETC1.6-4-2-3	45	LA45	33	MA46413 Series	27
EIN13 ♦	47	ETC16-1T-2TR	45	LA45-1	33	MA46416 Series	27
EIN14 ♦	47	ETC2-1T	43	<b>LA7</b>	<b>33</b>	MA46461 Series	27
EIN15 ♦	47	ETC3-1-1	44	<b>LF2802A</b>	<b>64</b>	MA46470 Series	27
EIN16 ♦	47	ETC36-1T-2	44	<b>LF2805A</b>	<b>64</b>	MA46471 Series	27
EIN8 ♦	47	<b>ETC4-1-2 ♦</b>	<b>43</b>	<b>LF2810A</b>	<b>64</b>	MA46472 Series	27
EIN9 ♦	47	ETC4-1-4	43	LG1 ♦	29	MA46473 Series	27
<b>ELCM-1</b>	<b>36</b>	ETC9-1T-5TR	45	LG30 ♦	29	MA46474 Series	27
EIN13 ♦	51	FD25 ♦	31	M14A ♦	39	MA46477 Series	27
EIN14 ♦	51	FD25C ♦	31	<b>M2A, M2AC ♦</b>	<b>37</b>	MA46480 Series	27
EIN15 ♦	51	FD25E ♦	31	M2B, M2BC ♦	37	MA46485 Series	27
EIN16 ♦	51	FD25H ♦	31	M2E, SM2E, M2EC ♦	37	MA46600 Series	27
		FD25HC ♦	31	M2T, M2TC ♦	37	<b>MA46H070 Series</b>	<b>27</b>
						<b>MA46H071 Series</b>	<b>27</b>

Note: Part numbers are RoHS compliant ♦ indicates non-RoHS compliant ✓ indicates RoHS5

## Part Number MA46H073 Series to MAAV-007089-000100

Part Number	Page No.	Part Number	Page No.	Part Number	Page No.	Part Number	Page No.
<b>MA46H073 Series</b> .....	<b>27</b>	MA4GP022 Series .....	25	<b>MA4ST1241,</b>		MAAM-008970 .....	12
<b>MA46H120</b> .....	<b>27</b>	MA4GP030 Series .....	25	<b>MAVR-001240 Series</b> .....	<b>28</b>	MAAM-009100 .....	12
<b>MA46H146</b> .....	<b>27</b>	MA4GP905 .....	25	<b>MA4SW110</b> .....	<b>57</b>	<b>MAAM-009286</b> .....	<b>13</b>
MA46H200 Series .....	27	MA4GP907 .....	25	<b>MA4SW210</b> .....	<b>58</b>	MAAM-009450 .....	12
<b>MA46H201 Series</b> .....	<b>27</b>	<b>MA4L011 Series</b> .....	<b>23</b>	<b>MA4SW210B-1</b> .....	<b>58</b>	MAAM-009451 .....	12
<b>MA46H202 Series</b> .....	<b>27</b>	<b>MA4L021 Series</b> .....	<b>23</b>	<b>MA4SW310</b> .....	<b>58</b>	MAAM-009452 .....	12
<b>MA46H203 Series</b> .....	<b>27</b>	<b>MA4L022 Series</b> .....	<b>23</b>	<b>MA4SW310B-1</b> .....	<b>58</b>	MAAM-009455 .....	12
MA46H204 Series .....	27	<b>MA4L031 Series</b> .....	<b>23</b>	MA4SW410 .....	58	MAAM-009503-AMI47A .....	16
MA46H501 Series .....	27	<b>MA4L032 Series</b> .....	<b>23</b>	<b>MA4SW410B-1</b> .....	<b>58</b>	<b>MAAM-009560</b> .....	<b>13</b>
MA46H503 Series .....	27	<b>MA4L062 Series</b> .....	<b>23</b>	MA4SW510 .....	58	<b>MAAM-009563</b> .....	<b>13</b>
MA4AGBLP912 .....	25	<b>MA4L101 Series</b> .....	<b>23</b>	<b>MA4SW510B-1</b> .....	<b>58</b>	MAAM-009633 .....	12
MA4AGFCP910 .....	25	<b>MA4L401 Series</b> .....	<b>23</b>	<b>MA4SW610B-1</b> .....	<b>58</b>	MAAM-009634 .....	12
MA4AGP907 .....	25	MA4M1050 .....	47	MA4VAT2000-1277T .....	20	MAAM-009778 .....	12
<b>MA4AGSW1</b> .....	<b>58</b>	MA4M1100 .....	47	MA4VAT2004-1061T .....	20	MAAM-009779 .....	12
<b>MA4AGSW1A</b> .....	<b>58</b>	MA4M3010 .....	47	MA4VAT2007-1061T .....	20	MAAM-009811 .....	12
<b>MA4AGSW2</b> .....	<b>58</b>	MA4M3030 .....	47	MA4VAT900-1277T .....	20	MAAM-009879 .....	12
<b>MA4AGSW3</b> .....	<b>58</b>	MA4M3050 .....	47	MA4VAT904-1061T .....	20	MAAM-010144 .....	12
<b>MA4AGSW4</b> .....	<b>58</b>	MA4M3100 .....	47	MA4VAT907-1061T .....	20	MAAM-010237 .....	12
<b>MA4AGSW5</b> .....	<b>58</b>	MA4M3150 .....	47	MAAD-000523 .....	21	MAAM-010263 .....	12
<b>MA4AGSW8-1</b> .....	<b>58</b>	MA4P1250-1072T .....	26	MAAD-007077-000100 .....	21	MAAM-010333 .....	13
<b>MA4AGSW8-2</b> .....	<b>58</b>	MA4P1450-1091T .....	26	MAAD-007078-000100 .....	21	MAAM-010355 .....	12
<b>MA4BN1840-1</b> .....	<b>58</b>	MA4P202 Series .....	25	MAAD-007079-000100 .....	21	MAAM-010373 .....	12
<b>MA4E1317</b> .....	<b>23</b>	MA4P203 Series .....	25	MAAD-007080-000100 .....	21	MAAM-010399 .....	12
<b>MA4E1318</b> .....	<b>23</b>	<b>MA4P303 Series</b> .....	<b>25</b>	MAAD-007081-000100 .....	21	MAAM-010513 .....	13
<b>MA4E1319-1</b> .....	<b>23</b>	MA4P4000 Series .....	26	MAAD-007082-000100 .....	21	MAAM-011101 .....	11
<b>MA4E1319-2</b> .....	<b>23</b>	MA4P404 Series .....	26	MAAD-007084-000100 .....	21	MAAM-011117 .....	12
<b>MA4E1338X1,</b>		MA4P4300 Series .....	26	MAAD-007085-000100 .....	21	MAAM-011122 .....	12
<b>MADS-001338 Series</b> .....	<b>24</b>	MA4P504 Series .....	26	MAAD-007086-000100 .....	21	<b>MAAM02350</b> .....	<b>11</b>
<b>MA4E1339X1,</b>		MA4P505 Series .....	26	MAAD-007251 ♦ .....	35	<b>MAAM02350-A2</b> .....	<b>11</b>
<b>MADS-001339 Series</b> .....	<b>24</b>	MA4P604 Series .....	25	MAAD-008866 .....	21	MAAM12000 .....	13
<b>MA4E1340X1,</b>		MA4P606 Series .....	25	MAAD-010305 .....	21	MAAM12000-A1 .....	14
<b>MADS-001340 Series</b> .....	<b>24</b>	MA4P607 Series .....	25	MAADCC0006 .....	21	<b>MAAM12031</b> ♦ .....	<b>14</b>
MA4E185-276 .....	24	MA4P7000 Series .....	26	<b>MAADSS0008</b> .....	<b>20</b>	MAAMSS0041 .....	12
MA4E190-276 .....	24	MA4P7100 Series .....	26	<b>MAADSS0009</b> .....	<b>20</b>	MAAMSS0042 .....	12
<b>MA4E2037</b> .....	<b>23</b>	<b>MA4P7433,</b>		<b>MAADSS0012</b> .....	<b>21</b>	MAAMSS0044 .....	12
<b>MA4E2039</b> .....	<b>23</b>	<b>MADP-007433 Series</b> .....	<b>26</b>	<b>MAADSS0016</b> .....	<b>21</b>	<b>MAAMSS0045</b> .....	<b>14</b>
<b>MA4E2040</b> .....	<b>23</b>	<b>MA4P7436,</b>		<b>MAADSS0018</b> .....	<b>21</b>	MAAMSS0060 .....	12
MA4E2054L-1261 .....	24	<b>MADP-007436 Series</b> .....	<b>26</b>	<b>MAADSS0019</b> .....	<b>21</b>	MAAP-008516 .....	14
<b>MA4E2054X1,</b>		<b>MA4P7437,</b>		MAAL-007304 .....	14	MAAP-008924 .....	15
<b>MADS-002054 Series</b> .....	<b>24</b>	<b>MADP-007437 Series</b> .....	<b>26</b>	<b>MAAL-007673</b> .....	<b>14</b>	MAAP-010168 .....	15
<b>MA4E2062 Series</b> .....	<b>24</b>	<b>MA4P7438,</b>		<b>MAAL-008091</b> .....	<b>13</b>	MAAP-010169 .....	14
MA4E2062, .....	24	<b>MADP-007438 Series</b> .....	<b>26</b>	<b>MAAL-008624</b> .....	<b>13</b>	MAAP-010171 .....	15
MADS-002062 Series .....	24	MA4P7441F-1091T .....	26	<b>MAAL-009120</b> .....	<b>14</b>	MAAP-010512 .....	15
MA4E2072, .....	24	MA4P7446F-1091T .....	26	<b>MAAL-010200</b> .....	<b>14</b>	MAAP-010516 .....	15
MADS-002072 Series .....	24	<b>MA4P7447,</b>		MAAL-010528 .....	14	MAAP-010517 .....	15
MA4E2160 .....	23	<b>MADP-007155 Series</b> .....	<b>26</b>	MAAL-010704 .....	12	MAAP-010518 .....	15
<b>MA4E2200X1,</b>		MA4P7452F-1072T .....	26	<b>MAAL-010704</b> .....	<b>14</b>	<b>MAAPSS0075</b> .....	<b>14</b>
<b>MADS-002200 Series</b> .....	<b>24</b>	MA4P7455-1225T .....	20	<b>MAAL-010705</b> .....	<b>14</b>	MAAP-002801 .....	41
MA4E2501L-1290 .....	24	<b>MA4P7455,</b>		<b>MAAL-010706</b> .....	<b>14</b>	MAAT-010521 .....	20
<b>MA4E2502 Series</b> .....	<b>24</b>	<b>MADP-007455 Series</b> .....	<b>26</b>	<b>MAALSS0042</b> .....	<b>14</b>	MAATCC0005 .....	21
<b>MA4E2508 Series</b> .....	<b>24</b>	MA4P7461F-1072T .....	26	<b>MAALSS0044</b> .....	<b>14</b>	MAATCC0006 .....	21
MA4E2513L-1289 .....	24	MA4P7464F-1072T .....	26	MAALSS0048 .....	14	MAATCC0007 .....	21
<b>MA4E2514 Series</b> .....	<b>24</b>	MA4P7470F-1072T .....	26	MAAM-007239 .....	12	MAATCC0008 .....	21
<b>MA4E2532 Series</b> .....	<b>24</b>	MA4PBL027 .....	25	MAAM-007501-SA2002 .....	11	MAATCC0009 .....	21
<b>MA4E2544L-1282</b> .....	<b>24</b>	MA4PH235-1072T .....	26	MAAM-007501-SA2002 .....	14	MAATCC0010 .....	21
MA4E914-276 .....	24	MA4PH236-1072T .....	26	MAAM-007501-SA2002 .....	18	MAATCC0011 .....	21
MA4E920-276 .....	24	MA4PH237-1072T .....	26	MAAM-007724 .....	12	MAATCC0012 .....	21
MA4E929A-119 .....	24	MA4PH238-1072T .....	26	MAAM-007796 .....	12	MAATCC0014 .....	21
MA4E929B-119 .....	24	MA4PH239-1072T .....	26	MAAM-007805 .....	12	MAATCC0017 .....	21
MA4E931Z2-1261A .....	24	MA4PK2000 Series .....	26	MAAM-007807 .....	12	<b>MAATSS00017</b> .....	<b>21</b>
MA4EX190H-1225T ♦ .....	38	MA4PK3000 Series .....	26	MAAM-008198-00A162 .....	17	<b>MAATSS0015</b> .....	<b>20</b>
MA4EXP190H-1277T ♦ .....	38	MA4SPS302 .....	25	MAAM-008199-000A51 .....	16	<b>MAATSS0016</b> .....	<b>21</b>
MA4EXP240L-1277T ♦ .....	39	MA4SPS402 .....	25	MAAM-008200-000A83 .....	16	<b>MAATSS0018</b> .....	<b>20</b>
MA4EXP950H-1277T ♦ .....	38	MA4SPS421 .....	25	MAAM-008818 .....	12	<b>MAATSS0019</b> .....	<b>21</b>
MA4EXP950L-1277T ♦ .....	38	MA4SPS422 .....	25	MAAM-008819 .....	12	<b>MAATSS0020</b> .....	<b>20</b>
MA4EXP950M-1277T ♦ .....	38	MA4SPS502 .....	25	MAAM-008820 .....	12	<b>MAATSS0021</b> .....	<b>20</b>
MA4FCP200 .....	25	MA4SPS552 .....	25	<b>MAAM-008821</b> .....	<b>12</b>	MAATSS0022 .....	21
MA4FCP300 .....	25	MA4ST1231, .....		MAAM-008822 .....	12	MAAV-007088-000100 .....	20
MA4FCP305 .....	25	<b>MAVR-001230 Series</b> .....	<b>28</b>	MAAM-008863 .....	13	MAAV-007089-000100 .....	20

Note: Part numbers are RoHS compliant ♦ indicates non-RoHS compliant

Blue listings indicate standard stock items widely available from our franchised distribution partners.

## Part Number MAAV-007090-000100 to MAFLCT0066

Part Number	Page No.	Part Number	Page No.	Part Number	Page No.	Part Number	Page No.
MAAV-007090-000100	20	<b>MABA-009180-500MHZ</b>	<b>43</b>	MABACT0069	45	MACPES0028	54
MAAV-007091-000100	20	MABA-009210-CT1760	44	MABACT0069	46	MACPES0050	51
MAAV-007092-000100	20	MABA-009210-CT1760	46	MABACT0071	43	MACPES0050	54
<b>MAAV-007941</b>	<b>20</b>	MABA-009231-CT1A4B	44	MABACT0071	46	MADL-011008	33
<b>MAAV-008022</b>	<b>20</b>	MABA-009232-CT4A4B	44	MABAES0010	43	MADP-000208-13180W	25
<b>MAAVSS0001</b>	<b>20</b>	MABA-009250-CT0068	45	MABAES0015	43	MADP-000907-14020W	25
MAAVSS0004	20	MABA-009298-CT48A0	43	<b>MABAES0025</b>	<b>44</b>	<b>MADP-007167 Series</b>	<b>26</b>
<b>MAAVSS0005</b>	<b>20</b>	MABA-009484-CT0068	43	MABAES0034	44	MADP-007167-12250T	20
<b>MAAVSS0006</b>	<b>20</b>	MABA-009484-ETC3IT	45	MABAES0040	43	MADP-008120-12790T	26
<b>MAAVSS0007</b>	<b>20</b>	MABA-009487-60HWCA	43	<b>MABAES0060</b>	<b>43</b>	MADP-017015-1314	25
<b>MAAVSS0008</b>	<b>20</b>	MABA-009488-61HWCA	43	MABAES0061	43	MADP-017025-1314	25
MABA-007159-000000	45	MABA-009492-C2W180	44	MABAES0061	45	MADP-030015-1314	25
<b>MABA-007159-000000</b>	<b>43</b>	MABA-009492-C2W180	46	MAC-50	36	MADP-030025-1314	25
MABA-007236-C16423	45	MABA-009573-CF1A40	44	MAC-51	36	MADP-042305-130600	25
MABA-007236-C16423	45	MABA-009573-CF1A40	46	MACP-007486-CH0010	51	MADP-042308-1305	25
<b>MABA-007237-ETC410</b>	<b>43</b>	MABA-009602-ES2922	45	MACP-007486-CH0010	54	MADP-042405-130600	25
MABA-00731-CT1980	45	MABA-009691-CT1881	44	MACP-007490-CA0010	51	MADP-042408-1305	25
MABA-00731-CT1980	46	MABA-009691-CT1881	46	MACP-007490-CA0010	54	MADP-042505-130600	25
MABA-007327-CT1490	43	MABA-009711-ETK2MM	45	MACP-007727-CI07B0	51	MADP-042508-1305	25
MABA-007327-CT1A40	44	<b>MABA-009711-ETK2MM</b>	<b>43</b>	MACP-007727-CI07B0	54	MADP-042905-130600	25
MABA-007327-CT1A40	46	MABA-009776-CF28A0	44	MACP-007741-CG09E0	51	MADP-042908-1305	25
MABA-007488-CT9550	44	MABA-009776-CF28A0	46	MACP-007741-CG09E0	54	MADP-064908-131000	25
MABA-007488-CT9550	46	MABA-009807-CF4010	43	MACP-007984-MDC201	52	MADR-007097-000100	29
MABA-007489-CT18A0	44	MABA-009836-CF48A0	46	MACP-008125-CK07F0	51	MADR-007098-000100	29
MABA-007489-CT18A0	46	MABA-009947-CF3160	43	MACP-008125-CK07F0	54	MADR-007131-000100	29
MABA-007493-CF4160	43	MABA-009947-CF3160	46	MACP-008248-CH0670	51	MADR-008851-000100	29
MABA-007493-CF4160	46	MABA-010012-ES4302	44	MACP-008248-CH0670	54	MADR-008888-000100	29
MABA-007532-CF18A0	44	MABA-010061-CF4FA0	46	MACP-008249-CH09B0	50	MADR-009190-000100	29
MABA-007532-CF18A0	46	MABA-010079-420T60	43	MACP-008249-CH09B0	54	MADR-009190-000DIE	29
MABA-007569-ETK42T	43	MABA-010125-TC1113	45	MACP-008311-CE0370	51	MADR-009269-000100	29
MABA-007681-CT2010	44	<b>MABA-010125-TC1113</b>	<b>43</b>	MACP-008311-CE0370	54	MADR-009296-000DIE	29
MABA-007681-CT2010	46	MABA-010129-CT4a40	44	MACP-008764-CH0370	51	MADR-009443-000100	29
MABA-007731-CT1980	45	MABA-010129-CT4A40	46	MACP-008764-CH0370	54	MADR-010140	29
MABA-007731-CT1980	46	MABA-010143-FLUX18	43	MACP-009404-C80370	54	MADR-010574-000100	29
MABA-007748-CT1160	44	MABA-010143-FLUX18	45	MACP-009404-C80370	51	MADRCC0004	29
MABA-007748-CT1160	46	MABA-010179-3WTTCl	43	MACP-009467-I05T12	51	MADRCC0005	29
MABA-007766-CF18A0	44	MABA-010181-CF9A40	44	MACP-009730-C60370	51	MADRCC0006	29
MABA-007766-CF28A0	46	MABA-010181-CF9A40	46	MACP-009730-C60370	54	MADRCC0007	29
MABA-007766-CF28A0	46	MABA-010245-CT1160	44	MACP-009736-CD0160	51	MADS-001317-1500	23
MABA-007819-CF48A0	44	MABA-010245-CT1160	46	MACP-009736-CD0160	54	MADS-002545-1307MG	24
MABA-007871-CT1A40	44	MABA-010247-2R1250	43	MACP-009821-CG0650	50	MADS-003000 Series	24
MABA-007902-CF3840	44	MABA-010273-ES1330	44	MACP-009821-CG0650	54	MAFC-010511	31
MABA-007902-CF3840	44	MABA-010273-ES1330	46	MACP-009943-CH07F0	51	MAFL-007492-CD0A00	55
MABA-007902-CF3840	46	MABA-010352-CT1A40	45	MACP-009943-CH07F0	54	MAFL-007654-CD0A10	55
MABA-008124-CF1FA0	44	MABA-010371-051837	47	MACP-010121-B8180X	52	MAFL-007898-CD0ACO	55
MABA-008124-CF1FA0	46	MABA-010655	43	MACP-010249-C108A0	51	MAFL-007988-CD0550	55
MABA-008182-CF1160	44	MABA-010721	46	MACP-010561	56	MAFL-008070-CLOAD0	55
MABA-008184-CT1760	44	MABA-011002	46	MACP-010562	56	MAFL-008098-CD0550	55
MABA-008184-CT1760	46	MABACT0039	46	MACP-010563	56	MAFL-008195-CD0ACO	55
MABA-008282-CFGA40	44	<b>MABACT0039</b>	<b>44</b>	MACP-010718	54	MAFL-008290-CD0ACO	55
MABA-008282-CFGA40	46	MABACT0040	44	MACPCC0001	52	MAFL-008571-CD0AFO	55
MABA-008482-CF1A40	46	MABACT0040	46	MACPCC0002	52	MAFL-008867-CB0B40	55
MABA-008482-CF1A40	43	MABACT0043	44	MACPCT0017	50	MAFL-008868-CB0B50	55
MABA-008570-ETC414	43	MABACT0048	44	MACPCT0017	54	MAFL-008869-CB0B60	55
MABA-008639-TC41T7	45	MABACT0048	46	<b>MACPCT0020</b>	<b>51</b>	MAFL-008870-CB0B70	55
<b>MABA-008752-TC1P57</b>	<b>43</b>	MABACT0056	44	MACPCT0030	51	MAFL-009010-CT0B90	55
MABA-008757-CT1160	44	MABACT0056	46	MACPCT0030	54	MAFL-009055-CD4254	55
MABA-008937-TC11T5	43	MABACT0059	43	MACPCT0038	51	MAFL-009810-CD0550	55
MABA-008965-CF1160	44	MABACT0059	46	MACPCT0038	54	MAFL-010256-CB0ADO	55
MABA-008965-CF1160	46	MABACT0062	43	MACPCT0039	51	MAFL-010464-CD0B20	55
MABA-009005-CF1A40	44	MABACT0062	46	MACPCT0039	54	MAFL-010465-CD0B20	55
MABA-009005-CF1A40	46	MABACT0063	44	MACPCT0040	51	MAFL-010467-CD0B20	55
MABA-009057-CT19E0	44	MABACT0063	46	MACPES0004	51	MAFL-011013	55
MABA-009057-CT19E0	46	MABACT0064	43	MACPES0004	54	MAFL-011018	55
MABA-009092-CT1A40	44	MABACT0064	46	MACPES0007	50	MAFL-011018	55
MABA-009092-CT1A40	46	MABACT0065	45	<b>MACPES0007</b>	<b>48</b>	MAFL-011018	55
MABA-009109-CF1A40	44	MABACT0066	44	<b>MACPES0017</b>	<b>51</b>	MAFLCT0027	55
MABA-009109-CF1A40	46	MABACT0066	46	MACPES0017	54	MAFLCT0027	55
MABA-009126-ET11SM	43	MABACT0067	44	<b>MACPES0017</b>	<b>51</b>	MAFLCT0027	55
MABA-009180-500MHZ	45	MABACT0067	46	MACPES0028	52	MAFLCT0031	55
				MACPES0028	52	MAFLCT0066	55

Note: Part numbers are RoHS compliant ♦ indicates non-RoHS compliant

## Part Number MAFLCT0081 to MASWSS0167

Part Number	Page No.	Part Number	Page No.	Part Number	Page No.	Part Number	Page No.
MAFLCT0081	55	MAOM-002201	41	MAPDCT0005	50	MASW-004102	58
MAFLCT0083	55	MAOM-002203	41	MAPDCT0010	47	MASW-005100-1194	58
MAFLES0102	55	MAOM-002204	41	MAPDCT0010	50	MASW-005102	58
MAFLES0122	55	MAOM-002207	41	MAPDCT0012	50	MASW-006102	58
MAGX-000035-010000	68	MAOM-003104	41	MAPDCT0012	48	MASW-007070-000100	59
MAGX-000035-01000S	68	MAOM-003105	41	MAPDCT0013	48	MASW-007071-000100	60
MAGX-000035-01500P	68	MAOM-003106	41	MAPDCT0013	50	MASW-007073-000100	61
MAGX-000035-030000	68	MAOM-004201	41	MAPDCT0024	48	MASW-007074-000100	61
MAGX-000035-05000P	68	MAOM-010567	41	MAPDCT0024	50	MASW-007075-000100	61
MAGX-000035-09000P	68	MAOM-011005	41	MAPDCT0026	48	MASW-007076-000100	61
MAGX-000912-125L00	68	MAPD-000900-12920T	49	MAPDCT0026	50	<b>MASW-007107</b>	<b>60</b>
MAGX-000912-250L00	68	MAPD-007246-ES4700	47	MAPDCT0027	48	<b>MASW-007221</b>	<b>59</b>
MAGX-001214-125L00	68	MAPD-007249-ESML21	48	MAPDCT0027	50	<b>MASW-007587</b>	<b>59</b>
MAGX-001214-250L00	68	MAPD-007530-000/00	49	MAPDCT0028	48	<b>MASW-007588</b>	<b>60</b>
MAGX-001214-500L00	68	MAPD-007778-C402E0	48	MAPDCT0028	50	<b>MASW-007813</b>	<b>60</b>
MAGX-001220-100L00	68	MAPD-007874-C20960	49	MAPDCT0029	48	<b>MASW-007921</b>	<b>60</b>
MAGX-002731-030L00	68	MAPD-007874-C20960	50	MAPDCT0029	50	<b>MASW-007935</b>	<b>59</b>
MAGX-002731-100L00	68	MAPD-008072-ESSM26	48	MAPDCT0030	48	<b>MASW-008075</b>	<b>59</b>
MAGX-002731-180L00	68	MAPD-008108-C202C0	48	MAPDCT0030	50	MASW-008153	61
MAHYB390-1303T	49	MAPD-008108-C202C0	50	MAPDCT0032	48	MASW-008177	61
MAHYB900-1292T	49	MAPD-008109-C30040	48	MAPDCT0032	50	<b>MASW-008206-000DIE</b>	<b>58</b>
MAHYCC0001	49	MAPD-008109-C30040	50	MAPDCT0033	48	MASW-008322	60
MALX-010136-80NHIN	47	MAPD-008185-C20720	49	MAPDCT0033	50	<b>MASW-008330</b>	<b>60</b>
MAMF-010614	14	MAPD-008185-C20720	50	<b>MAPF250128-150000</b>	<b>63</b>	MASW-008543	60
MAMX-000240-1225MT	38	MAPD-008812-0003HW	48	<b>MAPM-003088-010C12</b>	<b>66</b>	MASW-008566	60
MAMX-000900-1061LT	37	MAPD-008957-CT0012	47	<b>MAPM-003088-020C12</b>	<b>66</b>	MASW-008801	61
MAMX-007238-CM25MH	37	MAPD-009278-ST1000	48	<b>MAPM-020512-010C00</b>	<b>66</b>	<b>MASW-008853</b>	<b>60</b>
MAMX-007242-ES0103	37	MAPD-009492-C2W180	48	<b>MAPM-020512-010C12</b>	<b>66</b>	<b>MASW-008899</b>	<b>59</b>
<b>MAMX-008611</b>	<b>38</b>	MAPD-009492-C2W180	48	<b>MAPM-020512-040C00</b>	<b>66</b>	<b>MASW-008902-000DIE</b>	<b>58</b>
MAMX-008782-ES0118	38	MAPD-009492-C2W180	50	<b>MAPM-020512-060C00</b>	<b>66</b>	<b>MASW-008955</b>	<b>60</b>
MAMX-008786-ES0120	38	MAPD-009492-C2W180	50	<b>MAPM-020512-100C28</b>	<b>66</b>	MASW-009101	61
MAMX-009239-001500	37	MAPD-009673-C2DA40	48	<b>MAPM-030400-010C00</b>	<b>66</b>	<b>MASW-009276-0001DIE</b>	<b>58</b>
MAMX-009646-230BML	36	MAPD-009673-C2DA40	50	<b>MAPM-030400-060C00</b>	<b>66</b>	<b>MASW-009359</b>	<b>60</b>
MAMX-010458-000001	37	MAPD-009675-C2DA40	48	<b>MAPP-002729-300M00</b>	<b>66</b>	<b>MASW-009444</b>	<b>60</b>
MAMXES0022	36	MAPD-009850-HW1268	49	<b>MAPP-002731-250M00</b>	<b>66</b>	<b>MASW-009460</b>	<b>59</b>
MAMXES0028	36	MAPD-009851-HW2247	49	<b>MAPP-003134-130M2S</b>	<b>66</b>	MASW-009590-000DIE	58
MAMXES0041	37	MAPD-009918-C209C0	48	<b>MAPP-003134-150L00</b>	<b>66</b>	MASW-010350	61
MAMXES0050	39	MAPD-009918-C209C0	50	<b>MAPP-003134-150L00</b>	<b>66</b>	MASW-010351	61
MAMXES0072	36	MAPD-010038-C209C0	48	<b>MAPP-003134-180M00</b>	<b>66</b>	MASW-010612	60
MAMXES0108	36	MAPD-010038-C209C0	50	<b>MAPP-030400-100C2X</b>	<b>66</b>	MASW-011029	58
MAMXES0115	36	MAPD-010201-8022CG	49	<b>MAPPST2933-190M</b>	<b>66</b>	<b>MASW20000</b>	<b>58</b>
MAMXES0117	37	MAPD-010320-5070HR	49	<b>MAPR-000912-500S00</b>	<b>65</b>	<b>MASW20040</b>	<b>57</b>
<b>MAMXSS0010</b>	<b>38</b>	MAPD-011002	48	<b>MAPR-000912-700S00</b>	<b>65</b>	<b>MASW4030G</b>	<b>58</b>
<b>MAMXSS0011</b>	<b>37</b>	MAPD-011003	49	<b>MAPR-001011-850S00</b>	<b>65</b>	MASW4060G	58
<b>MAMXSS0012</b>	<b>38</b>	MAPD-011007	48	<b>MAPR-001090-165S00</b>	<b>65</b>	<b>MASW6010G</b>	<b>58</b>
MAMXSS0013	38	MAPDCC0001	49	<b>MAPR-001090-350S00</b>	<b>65</b>	<b>MASW6020G</b>	<b>57</b>
MAOC-009259	71	MAPDCC0002	49	<b>MAPR-001214-400M00</b>	<b>66</b>	MASW6030G	57
MAOC-009260	71	MAPDCC0003	49	<b>MAPR-002729-170M00</b>	<b>67</b>	MASWCC0006	61
MAOC-009261	71	MAPDCC0004	49	<b>MAPRST0002</b>	<b>66</b>	MASWCC0009	61
MAOC-009262	71	MAPDCC0005	49	<b>MAPRST0912-350</b>	<b>65</b>	MASWSS0091	61
MAOC-009263	71	MAPDCC0006	49	<b>MAPRST0912-50</b>	<b>65</b>	<b>MASWSS0093</b>	<b>63</b>
MAOC-009264	71	MAPDCC0007	49	<b>MAPRST1030-1KS</b>	<b>65</b>	MASWSS0100	61
MAOC-009265	71	MAPDCC0008	49	<b>MAPRST1214-150UF</b>	<b>66</b>	<b>MASWSS0103</b>	<b>64</b>
MAOC-009266	71	MAPDCC0009	49	<b>MAPRST1214-30UF</b>	<b>66</b>	MASWSS0107	61
MAOC-009267	71	MAPDCC0010	49	<b>MAPRST1214-6UF</b>	<b>66</b>	<b>MASWSS0115</b>	<b>62</b>
MAOC-009268	71	MAPDCC0011	49	MASL-011023	61	<b>MASWSS0121</b>	<b>63</b>
MAOC-009269	71	MAPDCC0014	49	<b>MASW-000105</b>	<b>61</b>	<b>MASWSS0129</b>	<b>61</b>
MAOC-009270	71	MAPDCC0015	49	MASW-000822-12770T	60	<b>MASWSS0130</b>	<b>62</b>
MAOC-009871	71	MAPDCC0016	49	MASW-000825-12770T	60	<b>MASWSS0136</b>	<b>62</b>
MAOC-009872	71	MAPDCC0017	49	MASW-000834-13560T	60	<b>MASWSS0143</b>	<b>62</b>
MAOC-010334	71	MAPDCC0018	49	MASW-000932-13500T	60	<b>MASWSS0144</b>	<b>63</b>
MAOM-001200	41	MAPDCC0019	49	MASW-000936-14000T	60	<b>MASWSS0148</b>	<b>62</b>
MAOM-001201	41	MAPDCC0020	49	<b>MASW-001100-1190</b>	<b>58</b>	<b>MASWSS0151</b>	<b>62</b>
MAOM-001600	41	MAPDCC0021	49	MASW-001150-1356	59	<b>MASWSS0157</b>	<b>62</b>
MAOM-002100	41	MAPDCT0002	50	<b>MASW-002100-1191</b>	<b>58</b>	<b>MASWSS0161</b>	<b>62</b>
MAOM-002103	41	MAPDCT0002	48	MASW-002102	58	<b>MASWSS0162</b>	<b>62</b>
MAOM-002105	41	MAPDCT0004	49	<b>MASW-003100-1192</b>	<b>58</b>	<b>MASWSS0166</b>	<b>62</b>
MAOM-002108	41	MAPDCT0004	50	MASW-003102	58	<b>MASWSS0167</b>	<b>63</b>
MAOM-002200	41	MAPDCT0005	48	MASW-004100-1193	58		

Note: Part numbers are RoHS compliant ♦ indicates non-RoHS compliant

Blue listings indicate standard stock items widely available from our franchised distribution partners.



## Part Number MASWSS0169 to PH1214-100EL

Part Number	Page No.	Part Number	Page No.	Part Number	Page No.	Part Number	Page No.
MASWSS0169	62	MAVC-010000-001965	72	MD-156	37	MRF317	64
MASWSS0175	62	MAVC-010000-002040	73	MD-158	37	MRF321	64
MASWSS0176	59	MAVC-010000-002048	73	MD-160	36	MRF323	64
MASWSS0178	60	MAVC-010000-002075	73	MD-161	36	MRF327	64
MASWSS0179	59	MAVC-010000-002100	73	MD-169	36	MRF392	64
MASWSS0180	59	MAVC-010000-002112	73	MD-179	36	MRF393	64
MASWSS0181	59	MAVC-010000-002140	73	MD-189	36	MRF421	63
MASWSS0184	59	MAVC-010000-002250	73	MD-614	37	MRF422	63
MASWSS0190	59	MAVC-010000-002300	73	MD22-0002-MUC	37	MRF426	63
MASWSS0191	60	MAVC-010000-002304	73	MD54-0003	38	MRF429	63
MASWSS0192	59	MAVC-010000-002310	73	MD54-0004	37	MRF448	63
MASWSS0199	60	MAVC-010000-002350	73	MD54-0005	38	MRF455	63
MASWSS0200	60	MAVC-010000-002450	73	MD54-0006	38	MRF455	63
MASWSS0201	59	MAVC-010000-002593	73	MD54-0007	39	MTH-50	47
MASWSS0202	60	MAVC-010000-002700	73	MD57-0001	38	MTV-50	49
MASWSS0204	59	MAVC-010000-002725	73	MD57-0002	38	MY50, MY50C	39
MATA-002800	41	MAVC-010000-002850	73	MDC-162	38	MY50A, MY50AC	39
MATA-002900	41	MAVC-010000-002950	73	MDC-163	38	MY51, MY51C	39
MATA-002902	41	MAVC-010000-003208	73	MDC-164	37	MY52, MY52C	39
MATA-003800	41	MAVC-010000-003500	73	MDC-169	36	MY63H, MY63HC	39
MATA-003803	41	MAVC-010000-003810	73	MDC-179	36	MY76H, MY76C	39
MATA-01802A	41	MAVC-010000-004060	73	MDS-148	37	MY76H, MY76HC	39
MATA-02802A	41	MAVC-110000-000626	74	MDS-149	37	MY77, MY77C	39
MATA-03802A	41	MAVC-110000-001632	74	MDS-169v	36	MY82, MY82C	38
MAUC-010515	35	MAVC-110000-001802	74	MDS-189	36	MY84, MY84C	38
MAVC-010000-000046	72	MAVC-130000-000534	74	MDS-222	36	MY85, MY85C	38
MAVC-010000-000080	72	MAVC-130000-000986	74	MDS-223	37	MY88, MY88C	38
MAVC-010000-000081	72	MAVC-140000-002304	74	MRF10005	65	MY89, MY89C	38
MAVC-010000-000122	72	MAVC-150000-000155	74	MRF1000MB	65	MY93, MY93C	38
MAVC-010000-000140	72	MAVC-150000-000220	74	MRF10031	65	MZ5210, MZ5210C	39
MAVC-010000-000217	72	MAVC-150000-000402	74	MRF1004MB	65	MZ7407, MZ7407C	39
MAVC-010000-000415	72	MAVC-150000-000455	74	MRF10120	65	MZ7410, MZ7410C	39
MAVC-010000-000425	72	MAVC-150000-000488	74	MRF10150	65	MZ7420, MZ7420C	39
MAVC-010000-000458	74	MAVC-150000-000784	74	MRF10350	65	MZ8810, MZ8810C	38
MAVC-010000-000492	72	MAVC-150000-000824	74	MRF10502	65	MZ8813, MZ8813C	38
MAVC-010000-000505	72	MAVC-150000-000856	74	MRF1090MB	65	MZ9310, MZ9310C	38
MAVC-010000-000512	72	MAVC-170000-001404	74	MRF1150MB	65	MZ9313, MZ9313C	38
MAVC-010000-000564	72	MAVC-170000-001620	74	MRF134	63	PA2001	18
MAVC-010000-000565	72	MAVC-170000-001946	74	MRF136	63	PA2001	14
MAVC-010000-000606	72	MAVR-000079 Series	28	MRF136Y	63	PA2001	14
MAVC-010000-000629	72	MAVR-000082Series	28	MRF137	63	PA2003	18
MAVC-010000-000755	72	MAVR-000083 Series	28	MRF140	63	PA2003	14
MAVC-010000-000768	72	MAVR-000120-14110G	27	MRF141	63	PA2010	14
MAVC-010000-000810	72	MAVR-000250 Series	28	MRF141G	63	PA2010	18
MAVC-010000-000829	72	MAVR-000320 Series	27	MRF148A	63	PA38	14
MAVC-010000-000896	72	MAVR-000340 Series	27	MRF150	63	PA38	18
MAVC-010000-000920	72	MAVR-000350 Series	27	MRF151	63	PA38-2	14
MAVC-010000-000942	72	MAVR-000401 Series	28	MRF151G	63	PA38-2	18
MAVC-010000-001033	72	MAVR-000403 Series	28	MRF154	63	PA48	15
MAVC-010000-001093	72	MAVR-000404 Series	28	MRF157	63	PA48	18
MAVC-010000-001293	72	MAVR-000405 Series	28	MRF158	63	PA511	14
MAVC-010000-001295	72	MAVR-000407 Series	28	MRF160	64	PA511	16
MAVC-010000-001305	72	MAVR-000408 Series	28	MRF16006	64	PA512	14
MAVC-010000-001325	72	MAVR-000409 Series	28	MRF16030	64	PA512	16
MAVC-010000-001326	72	MAVR-0001330 Series	27	MRF166C	64	PAW1027	12
MAVC-010000-001400	72	MAVR-001340 Series	27	MRF166W	64	PAW1027	14
MAVC-010000-001515	72	MAVR-001350 Series	27	MRF171A	64	PAW1027	16
MAVC-010000-001530	72	MAVR-044767 Series	23	MRF173	63	PAW1027-1	14
MAVC-010000-001564	72	MAVR-045438 Series	28	MRF173CQ	63	PAW1027-1	17
MAVC-010000-001625	72	MAVR-045440 Series	28	MRF174	63	PAW1027-1	12
MAVC-010000-001650	72	MAVR-045445 Series	28	MRF175GU	63	PD10-0042-S	49
MAVC-010000-001690	72	MAVR-045446 Series	28	MRF175GV	63	PH1090-15L	65
MAVC-010000-001691	72	MC4110	38	MRF175LU	63	PH1090-175L	65
MAVC-010000-001750	72	MC4520	39	MRF176GV	63	PH1090-350L	65
MAVC-010000-001802	72	MD-108	36	MRF177	63	PH1090-550S	65
MAVC-010000-001842	72	MD-113	36	MRF275G	64	PH1090-700B	65
MAVC-010000-001865	72	MD-124	36	MRF275L	63	PH1090-75L	65
MAVC-010000-001880	72	MD-148	37	MRF313	63	PH1113-100	66
MAVC-010000-001943	72	MD-149	37	MRF314	64	PH1214-0.85L	67
MAVC-010000-001960	72	MD-154	37	MRF316	64	PH1214-100EL	66

Note: Part numbers are RoHS compliant ♦ indicates non-RoHS compliant

## Part Number PH1214-110M to XZ1004-QT

Part Number	Page No.	Part Number	Page No.	Part Number	Page No.	Part Number	Page No.
PH1214-110M	66	PHA4000-1 ♦	66	SW-226	59	UF2840P	64
PH1214-12M	67	PHA4000-2 ♦	66	SW-227	60	XB1004-BD	15
PH1214-20EL	67	QH01-0016-G ♦	49	SW-228	60	XB1005-BD	15
PH1214-220M	66	RA36	18	SW-231 ♦	59	XB1007-BD	15
PH1214-25L	67	RA46	18	SW-233 ♦	60	XB1007-QT	18
PH1214-25M	67	RA62	18	SW-236 ♦	60	XB1008-BD	15
PH1214-25S	67	RA63-1	18	SW-241 ♦	60	XB1008-QT	18
PH1214-2M	67	RA66	17	SW-255 ♦	60	XB1014-QT	18
PH1214-300M	66	RA69	17	SW-261 ♦	60	XL1000-BD	13
PH1214-30EL	66	RA89	16	SW-283	61	XL1007-QT	14
PH1214-3L	67	RA89-1	17	SW-284	61	XL1010-QT	14
PH1214-40M	66	S10 ♦	61	<b>SW-311</b>	<b>59</b>	XM1001-BD	36
PH1214-55EL	66	<b>S11 ♦</b>	<b>61</b>	SW-312	59	XM1001-QH	39
PH1214-6M	67	SFD25 ♦	31	SW-313	61	XM1002-BD	36
PH1214-80M	66	SFD25H ♦	31	<b>SW-313</b>	<b>59</b>	XM1003-BD	36
PH2226-110M	67	SFD26 ♦	31	SW-314	61	XP1005-BD	14
PH2226-50M	67	<b>SM4T17</b>	<b>36</b>	<b>SW-314</b>	<b>60</b>	XP1026-BD	14
PH2729-110M	67	<b>SM5T ♦</b>	<b>37</b>	SW-369 ♦	61	XP1027-BD	14
PH2729-130M	67	SM5T17 ♦	37	SW-415	60	XP1031-QK	15
PH2729-25M	67	SM5TH ♦	37	SW05-0311	59	XP1035-QH	15
PH2729-65M	67	SM6D ♦	36	SW10-0312	59	XP1039-QJ	15
PH2729-8.5M	67	SM6EH ♦	36	SW10-0313	59	XP1042-QT	15
PH2731-20M	67	SMA21-1	13	SW15-0314	60	XP1043-QH	15
PH2731-5M	67	SMA80	17	T-1000 ♦	48	XP1050-QJ	15
PH2731-75L	67	SMLA88	33	THV-50 ♦	47	XP1080-QU	15
PH3134-10M	67	SMRA69	14	<b>TP-101 ♦</b>	<b>43</b>	XP9003-MB	14
PH3134-11S	67	SW-110	59	TP-102 ♦	43	XR1004-BD	35
PH3134-20L	67	SW-112 ♦	60	<b>TP-103 ♦</b>	<b>43</b>	XR1008-QB	35
PH3134-25M	67	SW-114 ♦	61	<b>TP-104 ♦</b>	<b>43</b>	XR1011-BD	35
PH3134-30S	67	SW-121 ♦	59	TP-105 ♦	43	XR1011-QH	35
PH3134-55L	67	SW-124 ♦	61	TP-108 ♦	45	XR1015-QH	35
PH3134-65M	67	SW-137	60	TP-75 ♦	43	XR1019-QH	35
PH3134-75S	67	SW-162 ♦	60	TPX-75-4 ♦	44	XU1004-BD	35
PH3134-9L	67	SW-163 ♦	60	TU-50 ♦	49	XU1009-BD	35
PH3135-20M	67	SW-164 ♦	61	<b>UF2805B</b>	<b>64</b>	XU1010-QH	35
PH3135-25S	67	SW-205 ♦	60	<b>UF28100H</b>	<b>64</b>	XU1019-QH	35
PH3135-5M	67	SW-206 ♦	60	<b>UF28100M</b>	<b>64</b>	XX1000-BD	31
PH3135-5S	67	SW-207 ♦	60	<b>UF28100V</b>	<b>64</b>	XX1000-QT	31
PH3135-65M	67	SW-214	59	<b>UF2810P</b>	<b>64</b>	XX1001-BD	31
PH3135-90S	67	SW-215 ♦	59	<b>UF28150J</b>	<b>64</b>	XX1002-QH	31
PHA2729-240M ♦	66	SW-216 ♦	59	<b>UF2815B</b>	<b>64</b>	XZ1003-QT	13
PHA2731-140L ♦	66	SW-224	59	<b>UF2820P</b>	<b>64</b>	XZ1004-QT	13
PHA3135-130M ♦	66	<b>SW-225</b>	<b>59</b>	<b>UF2840G</b>	<b>64</b>		

Note: Part numbers are RoHS compliant ♦ indicates non-RoHS compliant  
 Blue listings indicate standard stock items widely available from our franchised distribution partners.



*Partners in RF & Microwave*

**M/A-COM Technology Solutions Inc.**

Lowell, Massachusetts 01851  
North America 800.366.2266 • Europe +353.21.244.6400  
India +91-80-43537383 • China (Shanghai) +86.21.5108.6464  
[macomtech.com](http://macomtech.com)

MTS-L-052013

**MACOM™**