

# Assembly Instructions for - 37354

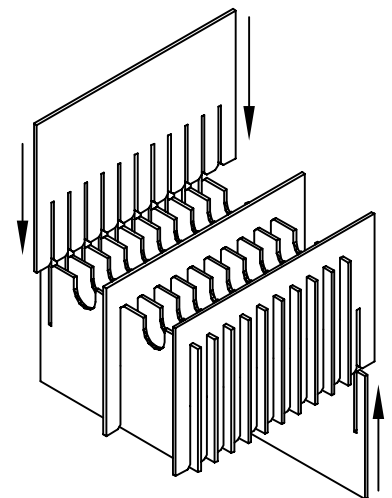
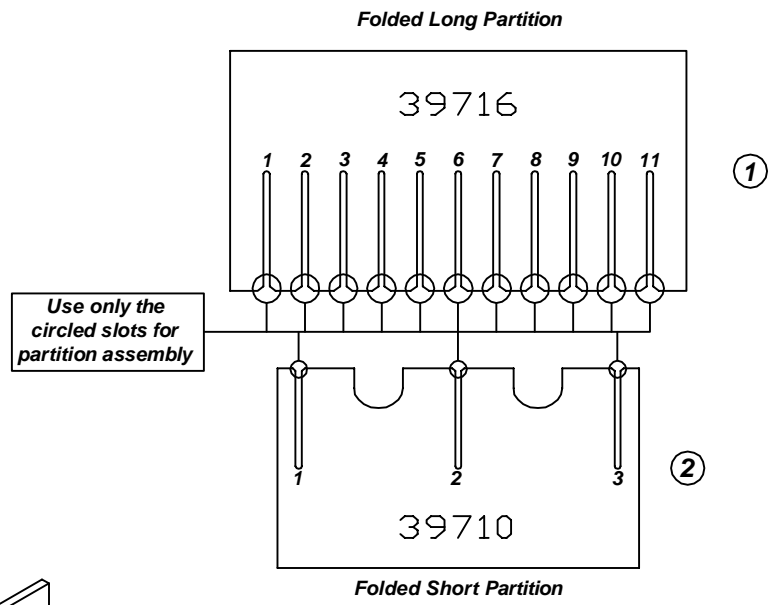
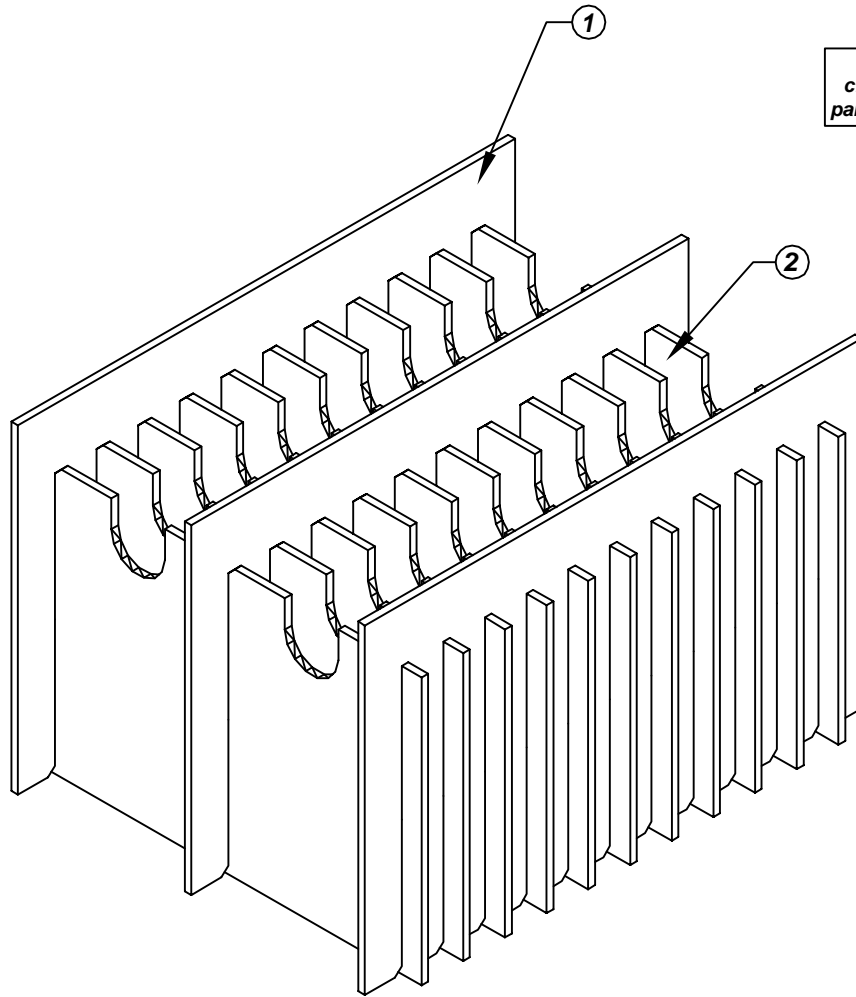

Made in America

F/N ①	Part # 39716	Dimensions: 24-1/4" x 18-5/8"	Description: 462-HLP-12 Long Partition	Qty: 3
F/N ②	Part # 39710	Dimensions: 20-1/4" x 14-3/4"	Description: 460/462/464-HSP Short Partition	Qty: 11

## 37354 - 24 Cell Inplant Handler Cell Size - 12" x 6-1/4" x 1-1/4"

Notes:  
For use with the following storage container & lid:  
37525 - Storage Container  
37554 - Lid

PROTEKTIVE PAK  
13520 MONTE VISTA AVENUE, CHINO, CA 91710  
PHONE (909) 627-2578, FAX (909) 363-7331  
ProtektivePak.com



DRAWING NUMBER  
**IPH-37354**

DATE  
Nov.  
2007