

Vlinx

MESR424

4-Port Industrial

Modbus Gateway



Vlinx MESR424

Documentation Number: MESR424_R002_4313m

This product was designed and manufactured in Ottawa, Illinois USA

Using domestic and imported parts by



International Headquarters

B&B Electronics Mfg. Co. Inc.
707 Dayton Road
Ottawa, IL 61350 USA

Phone (815) 433-5100 -- **General Fax** (815) 433-5105

Website: www.bb-elec.com

European Headquarters

B&B Electronics Ltd.
Westlink Commercial Park
Oranmore, Co. Galway, Ireland

Phone +353 91-792444 -- **Fax** +353 91-792445

Website: www.bb-europe.com

Revision Two – October 2013

©2012 B&B Electronics Mfg. Co. Inc. No part of this publication may be reproduced or transmitted in any form or by any means, electronic or mechanical, including photography, recording, or any information storage and retrieval system without written consent. Information in this manual is subject to change without notice, and does not represent a commitment on the part of B&B Electronics Mfg. Co. Inc.

B&B Electronics Mfg. Co. Inc. shall not be liable for incidental or consequential damages resulting from the furnishing, performance, or use of this manual.

All brand names used in this manual are the registered trademarks of their respective owners. The use of trademarks or other designations in this publication is for reference purposes only and does not constitute an endorsement by the trademark holder.

Table of Contents

1. Introduction	5
<i>About MESR424 Modbus Gateways</i>	<i>6</i>
<i>MESR424 Modbus Gateway Model Numbering</i>	<i>6</i>
<i>MESR 424 Features</i>	<i>7</i>
<i>Vlinx Manager Configuration Software</i>	<i>7</i>
2. MESR424 Modbus Gateway Hardware	8
<i>Package Checklist.....</i>	<i>8</i>
<i>MESR424 Modbus Gateway Enclosures and Mounting</i>	<i>8</i>
<i>LED Indicators</i>	<i>9</i>
E1/E2 Ethernet Link LED.....	9
Ready LED.....	9
Serial Port LEDs	10
<i>Mode/Reset Switch</i>	<i>10</i>
<i>Ethernet Connector</i>	<i>11</i>
<i>Fiber Optic Connectors.....</i>	<i>11</i>
<i>Serial Port Connectors.....</i>	<i>12</i>
<i>Power Connector.....</i>	<i>13</i>
<i>Mounting Hardware</i>	<i>14</i>
3. Modbus Gateway Setup and Connections	15
<i>Connecting the Power Supply</i>	<i>15</i>
<i>Connecting MESR424 Modbus Gateways to Modbus networks</i>	<i>15</i>
Connecting the MESR424.....	16
<i>Connecting MESR424 Modbus Gateways to a Network</i>	<i>17</i>
Network Connection (10BaseT/100BaseTX)	17
Fiber optic Connection	17
<i>MESR424 Modbus Gateway Configuration Connections</i>	<i>18</i>
Installing Modbus Configuration Manager Software	18
Configuring the MESR424 Modbus Gateway via the Network Connection	22
Configuring with Modbus Configuration Manager	22
Configuring with the Web Interface	36
Configuring the MESR424 Modbus Gateway on Networks without a DHCP Server	37
Configuring the MESR424 Modbus Gateway via the Serial Port (Console Mode)	40
<i>MESR424 Modbus Gateway Operational Connections</i>	<i>42</i>

Using MESR424 Modbus Gateways in Direct IP Mode	42
Initiating a Hardware Reset on the Modbus Gateway.....	43
Reloading Factory Defaults.....	43
4. Upgrading the Firmware.....	44
<i>Downloading Firmware Files.....</i>	<i>45</i>
<i>Uploading the Firmware to the Modbus Gateway</i>	<i>45</i>
5. Diagnostics	46
<i>Testing a Modbus Gateway Connection</i>	<i>46</i>
<i>Monitor Function</i>	<i>48</i>
6. Application Examples	49
<i>Ethernet Master and Serial Slaves</i>	<i>49</i>
<i>Serial & Ethernet Masters, Serial & Ethernet Slaves</i>	<i>53</i>
<i>Serial Masters, IP Slaves</i>	<i>55</i>
<i>Serial Masters, IP Slaves</i>	<i>58</i>
<i>Serial Masters, IP Slaves</i>	<i>59</i>
7. Modbus Help	60
<i>Modbus ASCII/RTU Basics</i>	<i>60</i>
<i>Hints and Tips.....</i>	<i>61</i>
8. Appendices.....	62
<i>Appendix A: Default Gateway Settings</i>	<i>63</i>
<i>Appendix B: Product Specifications.....</i>	<i>64</i>
General Specifications.....	65
Controls, Indicators and Connector Specifications	66
Serial Interface Specifications	67
Network Specifications	68
<i>Appendix C: Dimensional Diagrams</i>	<i>69</i>
<i>Appendix D: Connector Pinouts.....</i>	<i>70</i>
DB9 Serial Port Pinouts	70
Terminal Block Serial Port Pinouts	71

1. Introduction

Thank you for purchasing an MESR424 Modbus Gateway. This product has been manufactured to the highest standards of quality and performance to ensure your complete satisfaction.



Figure 1. MESR424 Modbus Gateways

About MESR424 Modbus Gateways

MESR424 Modbus Gateways connect Modbus networks (RS-232, RS-422 or RS-485) to Ethernet networks, allowing the Modbus network to become a node on the network. The serial ports can be accessed over a LAN/WAN using Direct IP Mode connections. MESR424 Modbus Gateways feature 10BaseT or 100BaseTX copper network media and fiber optic media options, depending on the model. MESR424 Modbus Gateways are built for use in industrial environments, featuring an IP30 approved slim line DIN rail mountable case. They operate from a range of DC power supply voltages and feature pluggable terminal block power connectors. An external power supply, sold separately, is required. MESR424 Modbus Gateways have an additional Ethernet port which functions much like an Ethernet Switch.

MESR424 Modbus Gateway Model Numbering

MESR424 Modbus Gateways are a growing family of products. Models are available with DB9 or Terminal Block connections. Network connection options include 10BaseT/100BaseTX copper or several different fiber optic options.

Model Number	Ethernet Port 1	Ethernet Port 1	Serial Ports
MESR424D	10/100 RJ45	10/100 RJ45	RS-232/422/485 (DB9 male)
MESR424D-MT	10/100 RJ45	Multi-mode (ST)	RS-232/422/485 (DB9 male)
MESR424D-SC	10/100 RJ45	Single-mode (SC)	RS-232/422/485 (DB9 male)
MESR424T	10/100 RJ45	10/100 RJ45	RS-232/422/485 (Terminal Block)
MESR424T-MT	10/100 RJ45	Multi-mode (ST)	RS-232/422/485 (Terminal Block)
MESR424T-SC	10/100 RJ45	Single-mode (SC)	RS-232/422/485 (Terminal Block)

MESR 424 Features

- Fiber models available
- Multi-interface serial ports
- DB-9M and pluggable terminal block serial port connector options
- All ports are software selectable as RS-232, RS-422 or RS-485 2- and 4-wire
- Configuration can be done via network or direct serial connection
- Slim line DIN rail mountable case
- Accepts DC power over a wide voltage range
- 10/100 Mbps Ethernet with Auto Selection, Auto MDI/MDIX
- LAN and WAN Communications
- TCP Client or Server operation - configurable
- Firmware Upload for future revisions/upgrades
- Software Support – Windows XP (32/64 bit), 2003 Server (32/64 bit), Vista (32/64 bit), 2008 Server (32/64 bit), Windows 7 (32/64 bit)
- Configuration of Ethernet and serial port settings using Vlinx Manager software

Vlinx Manager Configuration Software

Vlinx Manager configuration software enables you to find connected Modbus gateways, configure them, upgrade Modbus gateway firmware, and save/load configuration files. It features a graphical user interface (GUI) that is convenient and easy to use.

2. MESR424 Modbus Gateway Hardware

MESR424 Modbus Gateways are enclosed in DIN rail mountable enclosures and feature LED indicators, power, Ethernet and serial connectors and a recessed Mode/Reset switch.

Package Checklist

MESR424 Modbus Gateways are shipped with the following items included:

- MESR424 Modbus Gateway Module
- Quick Start Guide
- CD with User Manual, Quick Start Guide and configuration software.

MESR424 Modbus Gateway Enclosures and Mounting

All MESR424 Modbus Gateway models are built into similar enclosures. Modules are DIN rail and panel mountable.



Figure 2. Front View of an MESR424D Modbus Gateway

LED Indicators

MESR424 Modbus Gateways have three types of LED indicators: **Ethernet Link LEDs**, a **Ready LED** and **Serial Port LEDs**.

LEDs		
Power	Off	Power is not connected
	On	Power is connected
Ready	Off	System is in Console Mode
	Blink	System is in Normal Mode
P 1-4	Blink	Data present on serial port
RJ45 Ethernet Port LEDs		
Speed	Off	10BaseT connection
	On	100BaseTX connection
Link	On	Ethernet connected
	Blink	Data present on Ethernet port

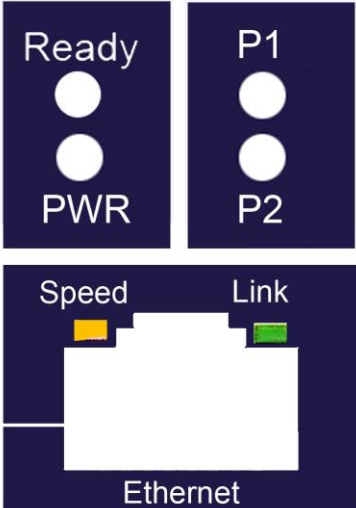

Figure 3. Port LEDs

E1/E2 Ethernet Link LED

The **Ethernet Link** LED (E1 or E2) illuminates (green) if the Ethernet is connected. When the LED is blinking it indicates that there is data traffic on the Ethernet link.

The **Ethernet Speed** (E1 or E2) LED is OFF if the connection is 10BaseT and ON if the Ethernet connections is 100BaseT.

E1 is used for all models to connect to the network. E2 is a pass-through Ethernet connector.

Ready LED

The **Ready** LED (green) blinks if the system is operating correctly, once per second in normal operating conditions, or three times per second in reset, configuration mode, or when loading factory defaults. If the LED is off or steady, it indicates the system is not operating correctly.

Serial Port LEDs

MESR424 Modbus Gateways feature multiple serial ports. Each serial port has an associated LED. Serial Port LEDs blink (green) when data is being transmitted or received on the serial port.



Figure 4. Serial Port LEDs

Mode/Reset Switch

A recessed momentary Mode/Reset switch is located next to the power ports. To activate the switch, insert a small plastic tool through the hole in the enclosure and press lightly.



Figure 5. Mode/Reset Switch

The Mode/Reset switch can be used to:

- Initiate a Hardware Reset
- Enter Console Mode
- Reload factory defaults

Ethernet Connector

MESR424 Modbus Gateway models using 10BaseT/100BaseTX network connections use RJ45 receptacles. The MESR424 Modbus Gateway is connected to a standard Ethernet network drop using a straight-through RJ45 (male) Ethernet cable.



Figure 6. Ethernet Connectors. E2 is pass-through connection on model shown

Fiber Optic Connectors

MESR424 Modbus Gateway models using fiber optic network connections use either SC or ST connectors, depending on the specific model.

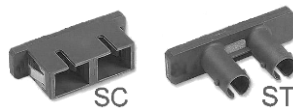

Figure 7. SC and ST Fiber Optic Cable Connectors

Serial Port Connectors

MESR424 Modbus Gateways use a variety of serial port connector configurations, depending on the model:

Model Number	Ethernet Port 1	Ethernet Port 2	Serial Ports
MESR424D	10/100 RJ45	10/100 RJ45	RS-232/422/485 (DB9 male)
MESR424D-MT	10/100 RJ45	Multi-mode (ST)	RS-232/422/485 (DB9 male)
MESR424D-SC	10/100 RJ45	Single-mode (SC)	RS-232/422/485 (DB9 male)
MESR424T	10/100 RJ45	10/100 RJ45	RS-232/422/485 (Terminal Block)
MESR424T-MT	10/100 RJ45	Multi-mode (ST)	RS-232/422/485 (Terminal Block)
MESR424T-SC	10/100 RJ45	Single-mode (SC)	RS-232/422/485 (Terminal Block)



Figure 8. DB-9 Female Serial Port Connector



Figure 9. Five-Position Pluggable Terminal Block

Power Connector

Power may be supplied by terminal block or a barrel jack.

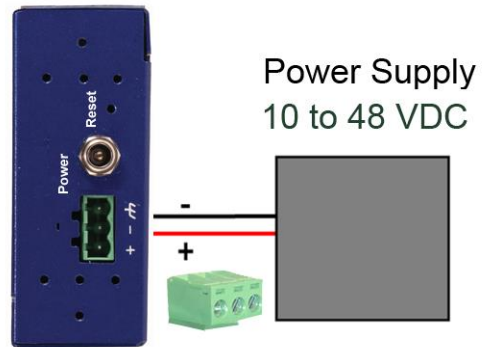

Figure 10. Power Connection

NOTE: the terminal block must be used for Class 1 Division 2 applications; the barrel jack cannot be used for these applications. See page 66 for further information.

Mounting Hardware

MESR424 Modbus Gateway modules can be panel or DIN rail mounted. Mounting hardware is included with each module.

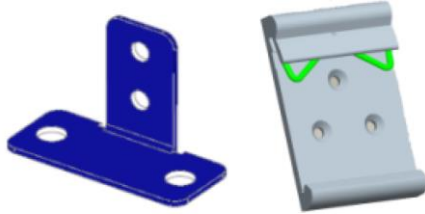

Figure 11. Mounting clips



Figure 12. Mounting clips

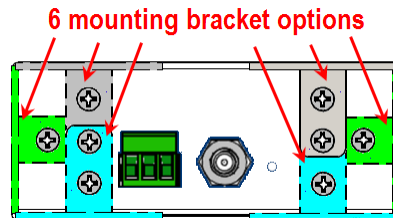

Figure 13. Panel mount bracket options

3. Modbus Gateway Setup and Connections

Connecting the Power Supply

Connect a DC power supply to the power terminals on the top of the MESR424 Modbus Gateway. Polarity of the wires is indicated on the label on the side of the Modbus gateway. Acceptable voltages are between 10 VDC and 48 VDC. The power supply must be capable of supplying 6 W.



Figure 14. MESR Power Connection

NOTE: the terminal block must be used for Class 1 Division 2 applications; the barrel jack cannot be used for these applications. See page 66 for further information.

Connecting MESR424 Modbus Gateways to Modbus networks

MESR424 Modbus Gateways can be configured to connect to Modbus networks using RS-232, RS-422, RS-485 2-wire and RS-485 4-wire.

RS-232 connections support eight signal lines plus Signal Ground. Signals are single ended and referenced to Ground. Default communications parameters are 9600, 8, N, 1 and no flow control implemented.

RS-422 connections support two signal pairs: RXA(-), RXB(+) and TXA(-), TXB(+), plus GND. The data lines are differential pairs (A & B) in which the B line is positive relative to the A line in the idle (mark) state. Ground provides a common mode reference.

RS-485 connections support 2-wire or 4-wire operation.

When configured for **4-wire operation** the connection supports two signal pairs: RXA(-), RXB(+) and TXA(-), TXB(+), plus GND. This makes full-duplex operation possible. The

3. Setup and Connections

data lines are differential pairs (A & B) in which the B line is positive relative to the A line in the idle (mark) state. Ground provides a common mode reference.

When configured for **2-wire operation** the connection supports one signal pair: DataB(+) and DataA(-) signal channels using half-duplex operation. The data lines are differential with the Data B line positive relative to Data A in the idle (mark) state. Ground provides a common mode reference.

Connecting the MESR424

Depending upon the model, MESR424 Modbus Gateway can be configured to support RS-232, RS-422 and RS-485 (2- and 4-wire) serial connectors. The unit may have DB-9M connectors or 5-position terminal blocks.

If you select RS-232 mode when you configure the MESR424 Modbus Gateway, you must connect the Modbus serial network to the MESR424 Modbus Gateway via a serial cable. The MESR424 Modbus Gateway is a DTE. If the Modbus network is a DTE, use a null modem (cross-over) cable. If the Modbus network is a DCE, use a straight-through cable. DTE and DCE ports are complementary, the **Output** signals on a DTE port are **Inputs** to a DCE port, and **Output** signals on a DCE port are **Inputs** to a DTE port. The signal names match each other and connect pin for pin. Signal flow is in the direction of the arrows. (See figure below)

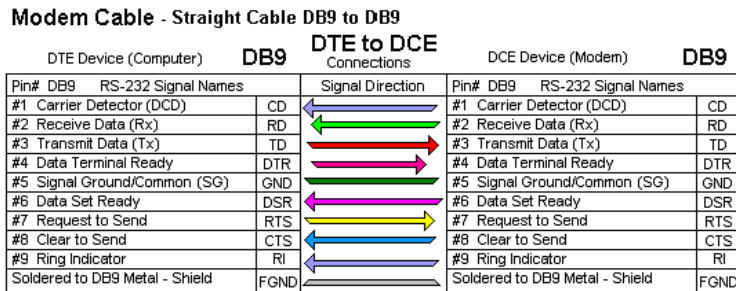

Figure 15. MESR RS-232 Connections

If you select RS-422 mode, RS-485 2-wire mode, or RS-485 4-wire mode when you configure the MESR424 Modbus Gateway, you must connect the Modbus network appropriately, via the 5-position terminal block or the DB9 connector.

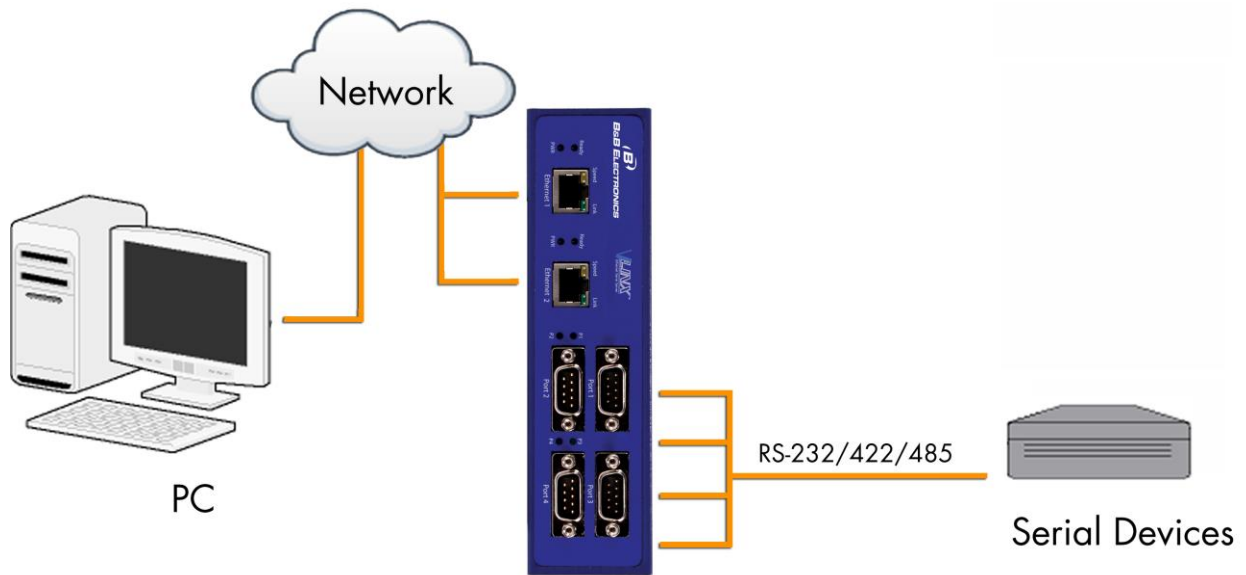

Figure 16. MESR Connections

Connecting MESR424 Modbus Gateways to a Network

Network Connection (10BaseT/100BaseTX)

When connecting an MESR424 Modbus Gateway equipped with a **10BaseT/100BaseTX network connection** (RJ45 connector) a standard network cable is connected from the Modbus gateway to a network drop. PCs configuring and/or communicating with the Modbus gateway are also connected to the network.

Fiber optic Connection

When connecting a MESR424 Modbus Gateway equipped with a **fiber optic interface to a fiber optic link** the appropriate fiber optic cable must be connected between the Modbus gateway and the network interface.

MESR424 Modbus Gateway Configuration Connections

MESR424 Modbus Gateways can be configured over the network or via a serial port.

Installing Modbus Configuration Manager Software

1. The Modbus Configuration Manager Software is contained on the CD which is packaged with the product. Insert the CD into your CD ROM drive. The software should automatically begin the installation process. If AUTO RUN is disabled on your computer, open the CD drive and double click on the executable file. Choose **i386\MESR32.exe** for 32-bit Windows or **amd64\MESR64.exe** for 64-bit Windows.
 - a. The following screen will be displayed on your computer.



Figure 17. Modbus Gateway Manager Installation Welcome Screen

- b. Click “Next.” The License Agreement Screen will be displayed on your computer.

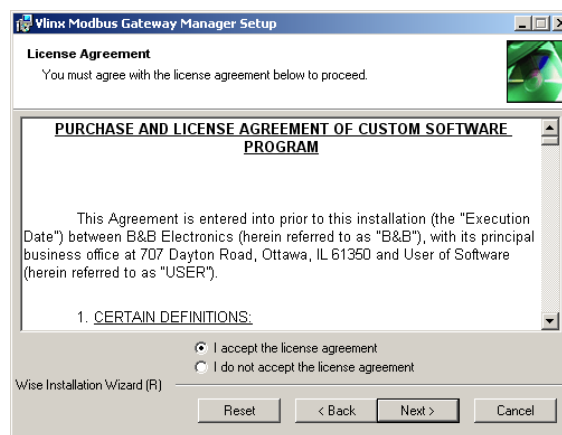

Figure 18. Modbus License Acceptance Screen

3. Setup and Connections

- c. Click “Next.” The User Information Screen will be displayed on your computer. Enter your name and organization (optional) and select if the software will be accessible to your account or anyone who uses the computer.

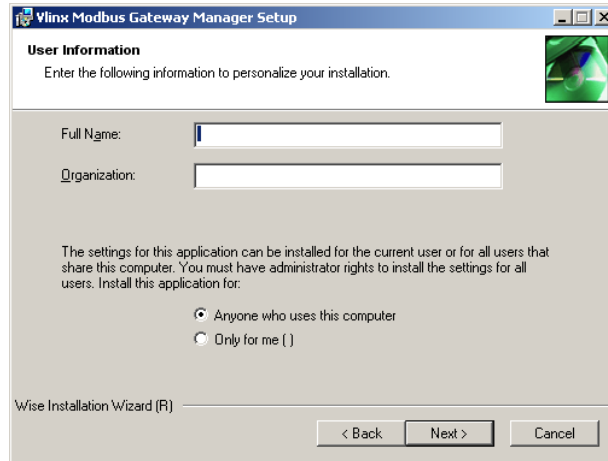

Figure 19. User Information Screen

- d. Click “Next.” The Destination Folder Screen will be displayed on your computer. The default directory is:

C:\Program Files\B&B Electronics\Vlinx\Vlinx Modbus Gateway Manager\

If desired, you can select another location by pressing the “Browse” button.

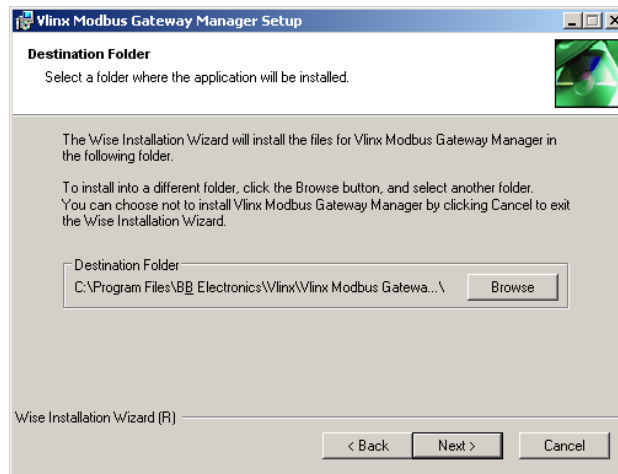

Figure 20. Destination Folder Screen

- e. Click “Next.” The Ready to Install Application Screen will be displayed on your computer. You can select the “Back” button to change destination folder.

3. Setup and Connections

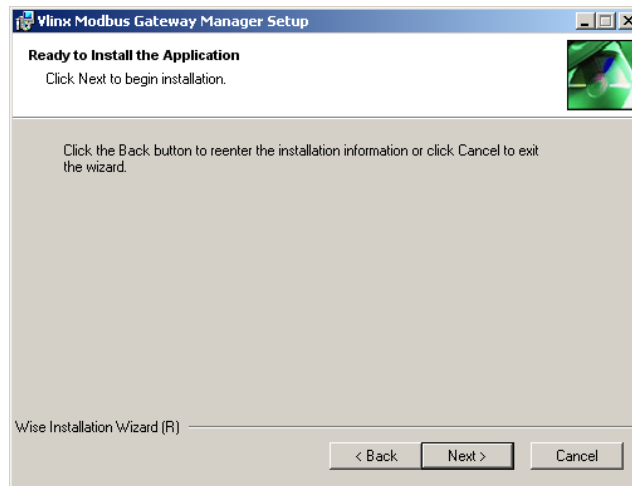

Figure 21. Ready to Install Application Screen

- f. Click "Next." The software will begin installing.

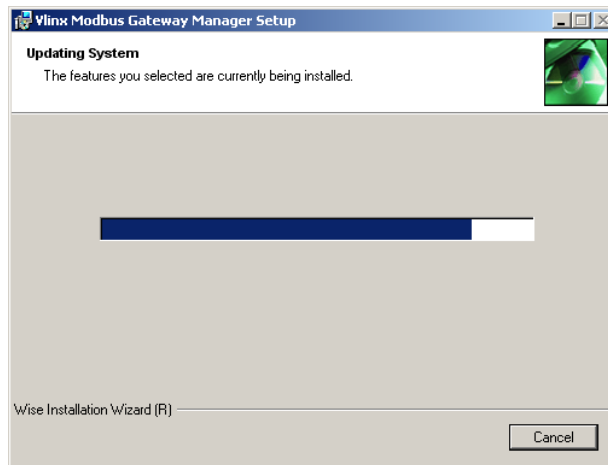

Figure 22. Software Installing Screen

3. Setup and Connections

- g. After the installation is complete, an information screen will be displayed containing contact information and release notes. Click “Next.”

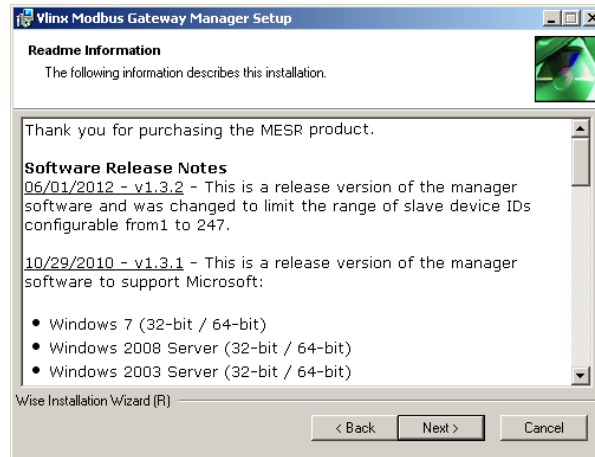

Figure 23. Information Screen

- h. Click “Next.” The Installation Complete screen will be displayed on your computer. Click “Finish” to finish the installation.

- i.



Figure 24. Installation Complete Screen

Configuring the MESR424 Modbus Gateway via the Network Connection

When configuring via the network, either Modbus Configuration software or the web interface can be used.

Configuring with Modbus Configuration Manager

MESR424 Modbus Gateways can be configured over the network Modbus Configuration manager software running on a PC.

To open Modbus Configuration Manager:

1. From the Desktop, click Start → Programs → B&B Electronics → Vlinx → Vlinx Modbus Gateway Manager. An alternate method is to double click the shortcut installed on the desktop.
- 2.

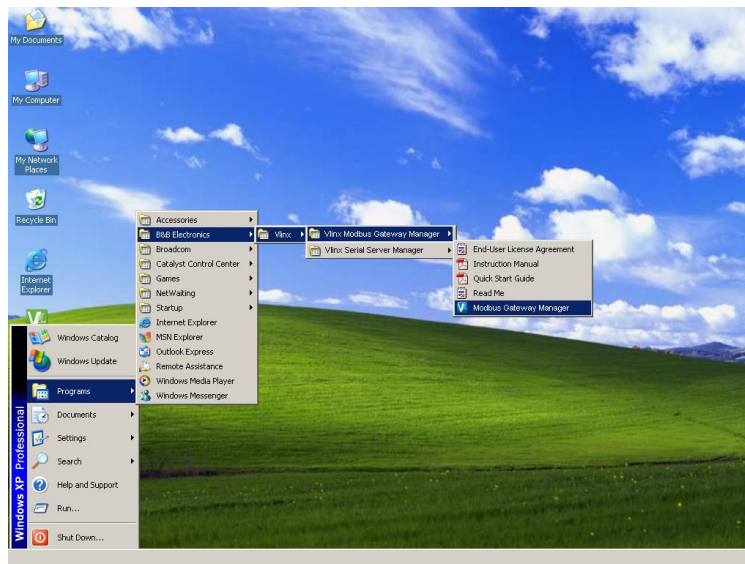

Figure 25. Opening Vlinx Modbus Gateway Manager

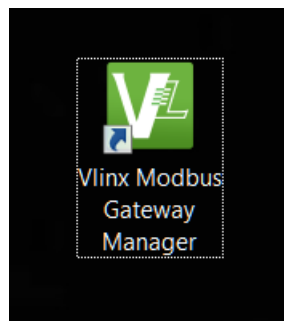

Figure 26. Vlinx Modbus Gateway Manager Shortcut Icon

3. Setup and Connections

3. The Vlinx Modbus Configuration Manager Device Discovery window appears.

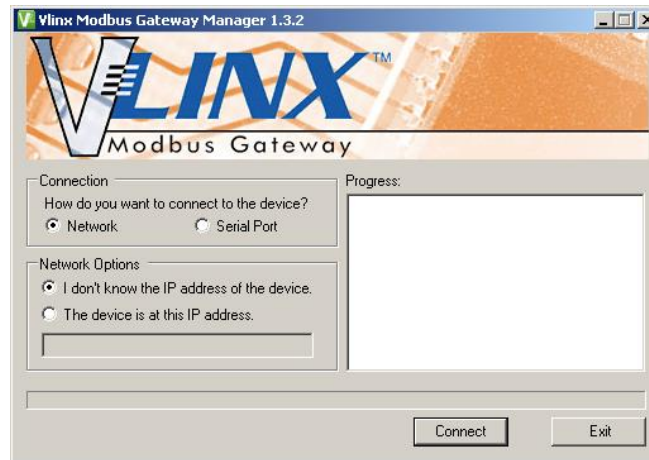

Figure 27. Vlinx Modbus Configuration Manager Discovery Window

4. If you do not know the IP address, check the “Network” and “I don’t know the IP address of this device” selections and press the “Connect Button.” The software will discover any Modbus Gateways on the network. The configuration manager screen will be displayed on your computer. All available devices will be listed on the top portion of this screen. If you know the IP address, you may select “The Device is located at this IP address” and input the address in the box provided.

- 5.

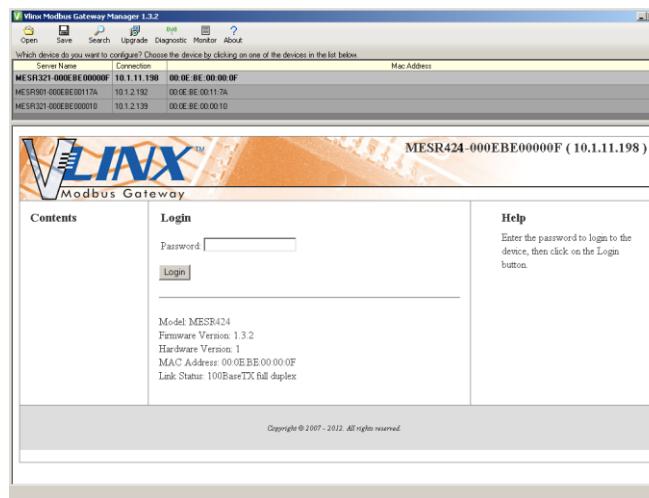

Figure 28. Configuration Manager Screen

6. All Modbus Gateways on the network will be displayed in the top portion of the screen. To select a gateway, simply click the appropriate device on the top portion of the screen.

3. Setup and Connections

- a. The main portion of the screen displays the Model, Firmware version, Hardware Version, MAC Address, and Link Status. The IP Address is also displayed on the top portion of the screen and title graphic area.
7. The default password is no password. Click the “Login” button. The “General” Settings screen will be displayed on your computer.
8. Vlinx Modbus Manager Settings Screen Overview

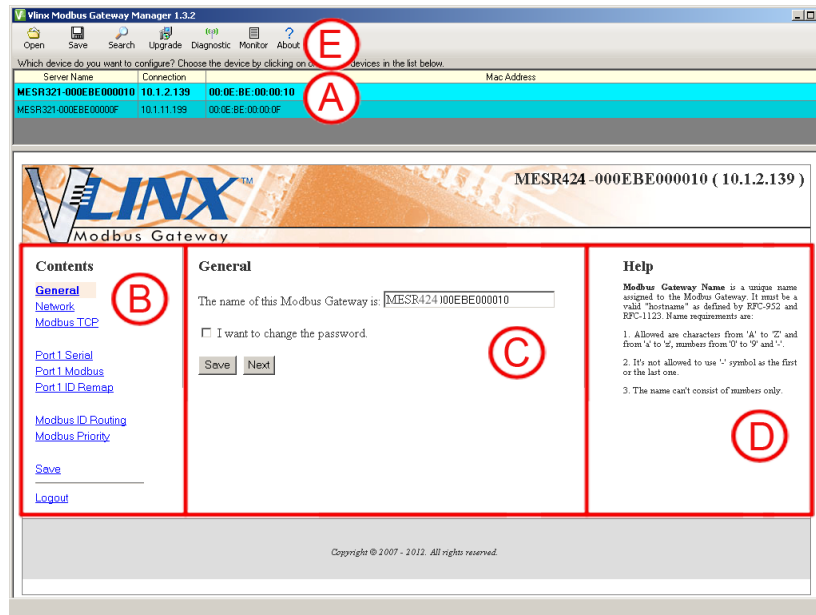

Figure 29. Settings Screen Overview

- a. This area shows Modbus Gateways available on the network.
- b. This area is used to skip directly to the specific configuration screen you need to access. An alternate method of accessing the configuration screens is to use the “Next” button in area C.
- c. This area contains dialog boxes specific the configuration screen.
 1. **Note: Any configuration changes you make need to be saved using the “Save” button.**
- d. This area contains helpful information about the configuration screen you are currently on.
- e. This area contains shortcuts to specific functions.
 1. Open allows you to load a previously saved configuration file into your Modbus Gateway.
 2. Save allows you to save your configuration to a file. This should not be confused with the “Save” button described in 6.c above.

3. Setup and Connections

3. Search allows you to search for Modbus Gateways on the network.
4. Upgrade allows you to upgrade your Modbus Gateway's firmware.
5. Diagnostic allows you to test a configured Modbus Gateway. See Section 5.
6. Monitor allows you to monitor a Modbus Gateway. See Section 5.
7. About contains information about your Modbus Gateway.

9. General Settings

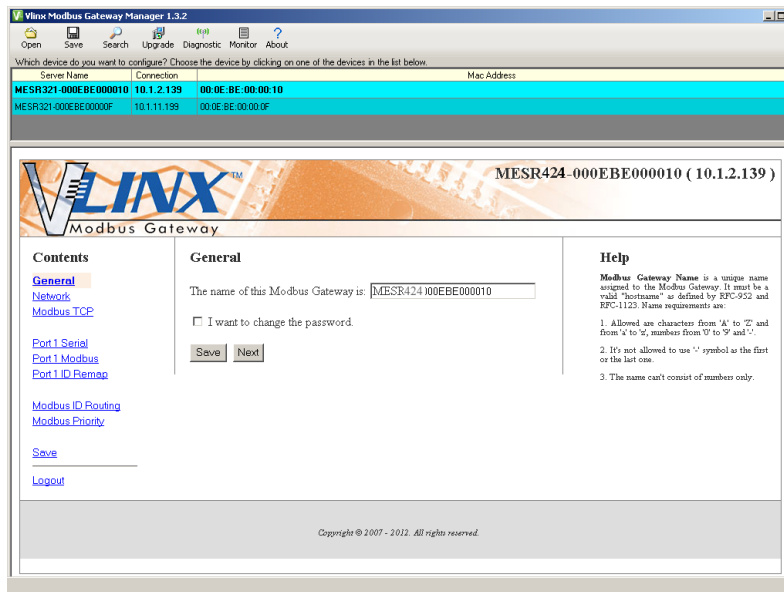

Figure 30. General Settings Screen

- a. This screen enables you to assign a unique name to the gateway. This allows you to easily identify a particular gateway when multiple devices are used on the same network. To change the name, type a new name in the “The Name of this Modbus Gateway is” box. The name must be a valid "hostname" as defined by RFC-952 and RFC-1123. Allowed characters are A to Z, a to z, 0 to 9 and “-“. The “-“ symbol cannot be the first or last character. The name cannot consist of numbers only. **To save the new name click the “Save” button.**
- b. You can also change the gateway's password on this screen. To do this, check the “I want to change the password” box. New password entry boxes will appear on the screen.

3. Setup and Connections

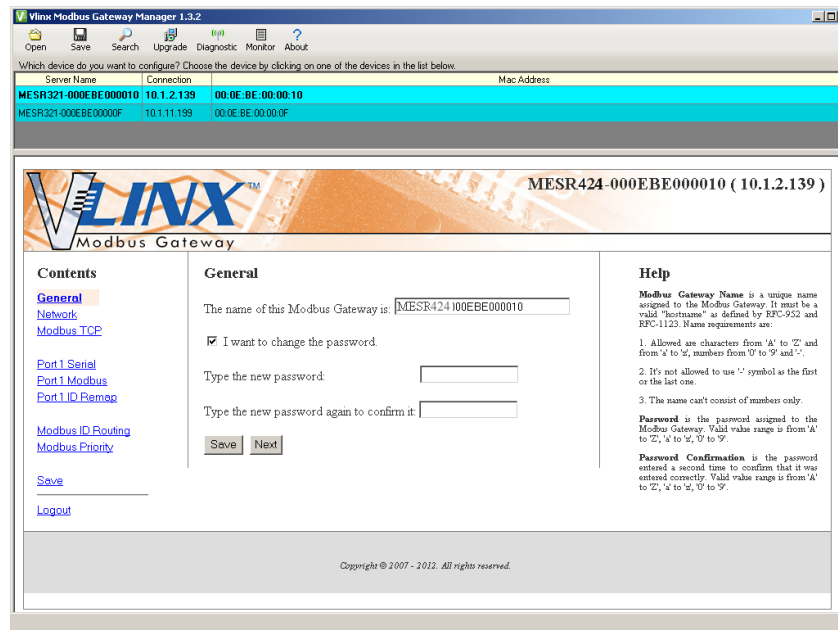

Figure 31. Changing The Password

- c. Type your new password in the “Type the new password box.” Verify the password by typing it again in the box provided. **To save the new password click the “Save” button.**

10. Network Settings

- a. To get to the Network Settings Screen you can either click the “Next Button” or click on the “Network” link on the left side of the screen.

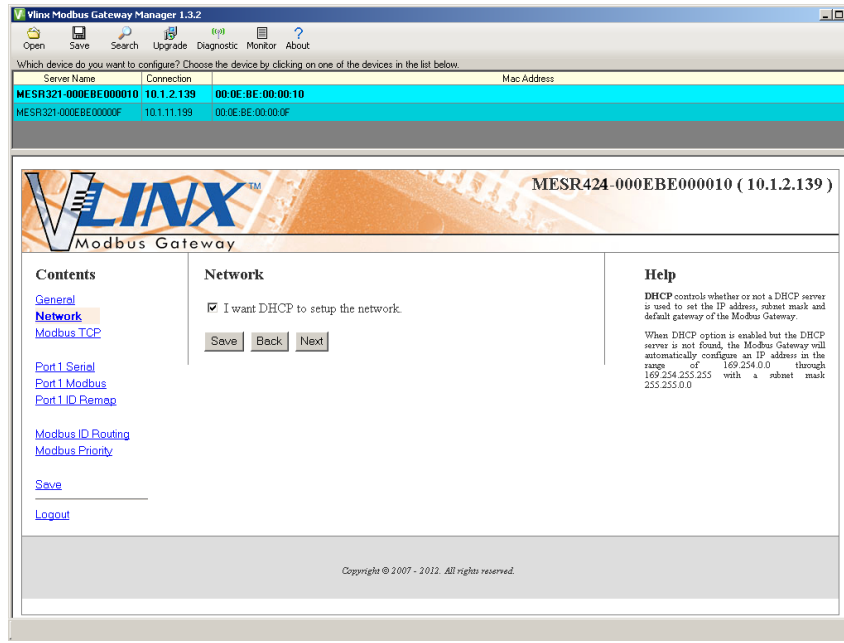

Figure 32. Network Settings Screen (DHCP Selected)

- b. The default network configuration is to receive an IP address assignment from a DHCP server. **DHCP** controls whether or not a DHCP server is used to set the IP address, subnet mask and default gateway of the Modbus Gateway. When DHCP option is enabled but the DHCP server is not found, the Modbus Gateway will automatically configure IP address 1169.254.255.255 with a subnet mask 255.255.0.0
- c. To configure your Modbus Gateway without using a DHCP Server, uncheck the “I want DHCP to setup the network” box. You will need to know the IP Address, Subnet Mask, and Default Gateway.

IP Address field contains static internet protocol address of the Modbus Gateway.

Subnet Mask field contains mask that is used to define sub network.

For Class A network (IP addresses 0.0.0.0 through 127.255.255.255), the default subnet mask is 255.0.0.0.

For Class B network (IP addresses 128.0.0.0 through 191.255.255.255), the default subnet mask is 255.255.0.0.

3. Setup and Connections

For Class C network (IP addresses 192.0.0.0 through 223.255.255.255), the default subnet mask is 255.255.255.0.

For Class D network (IP addresses 224.0.0.0 through 239.255.255.255) and Class E network (IP addresses 240.0.0.0 through 255.255.255.255), the subnet mask is ignored.

Default Gateway field contains default route to remote networks.

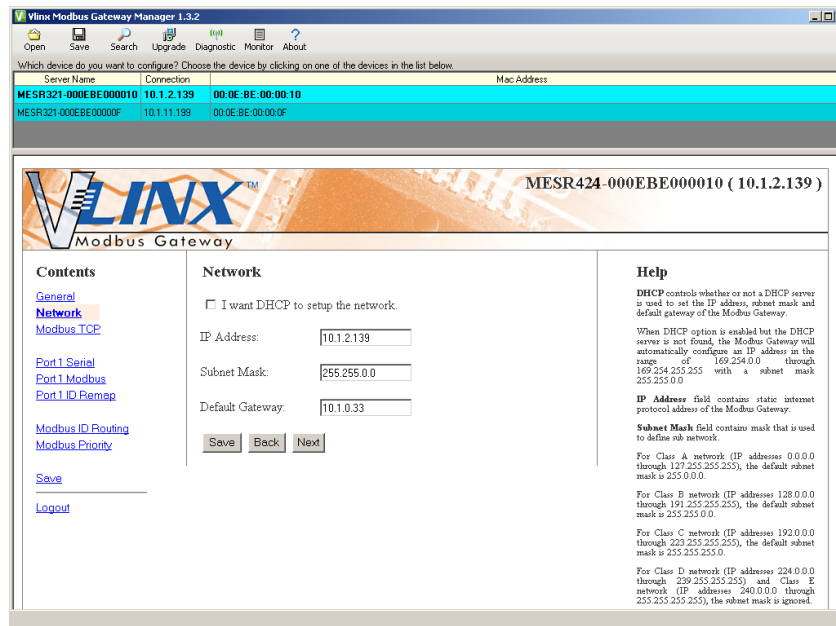

Figure 33. Network Settings Screen (DHCP not Selected)

- d. More information about assigning an IP address without using a DHCP Server is contained in the section [Configuring the MESR424 Serial Server on Networks without a DHCP Server](#).
- e. Save changes by Clicking the “Save” button.

11. Modbus TCP Settings

- a. To access this screen, click the “Next Button” or click on the Modbus TCP link on the left side of the screen.
- b. This screen allows you Modbus TCP client and server settings.

3. Setup and Connections

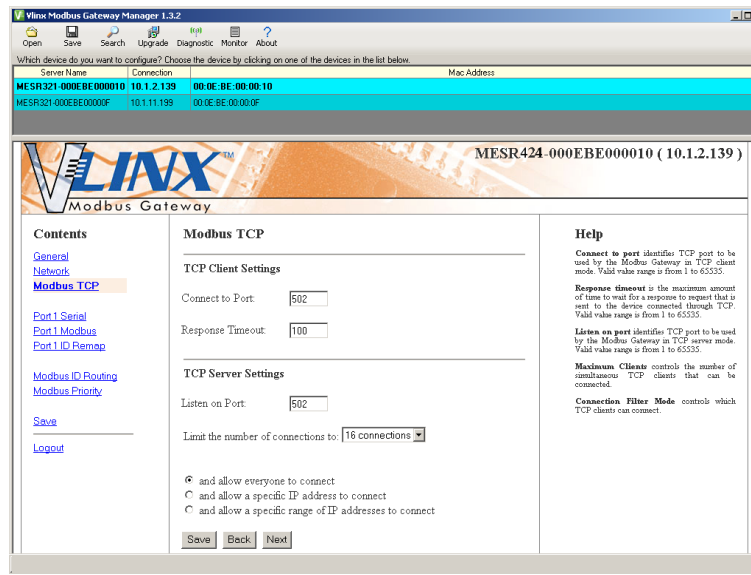

Figure 34. Modbus TCP Settings Screen

c. TCP Client Settings

1. Connect to Port identifies TCP port to be used by the Modbus Gateway in TCP client mode. Valid value range is from 1 to 65535.
2. Response Timeout is the maximum amount of time to wait for a response to a request that is sent to the device connected through TCP. Valid value range is from 1 to 65535.
3. Save settings by clicking the “Save” button.

b. TCP Server Settings

1. Listen on Port identifies TCP port to be used by the Modbus Gateway in TCP server mode. Valid value range is from 1 to 65535.
2. “Limit the number of connections to” pull down box allows you to control the number of simultaneous TCP clients that can be connected. Choices are 1 through 16.
3. Connection Filter Mode controls which TCP clients are able to connect. The default is: “and allow everyone to connect.”
 - a. You can select “allow specific IP addresses to connect.” This filter is limited to 4 IP addresses.

3. Setup and Connections

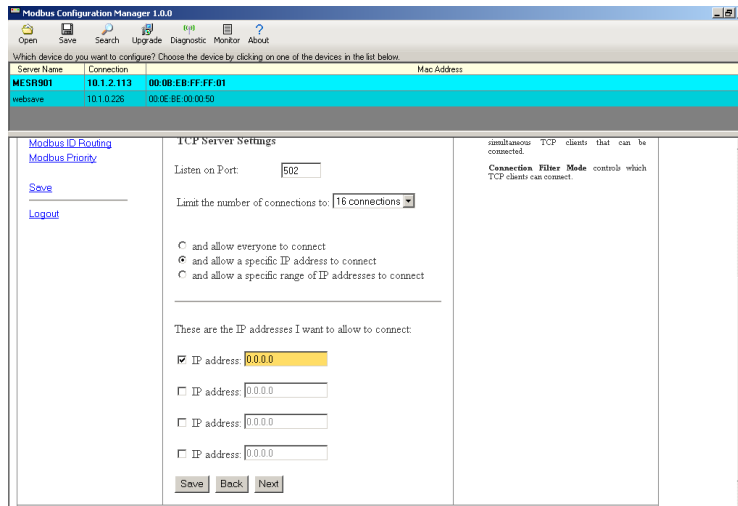

Figure 35. TCP Connection Filter “Allow Specific IP addresses to Connect”

- b. You can select “a specific range of IP addresses to connect.” This filter is limited to 4 IP address ranges.
- c. Save settings by clicking the “Save” button.

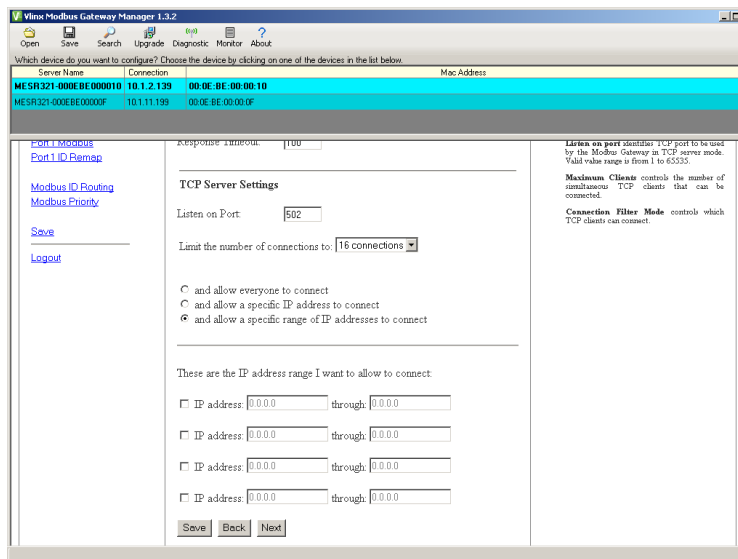

Figure 36. TCP Connection Filter “Allow Specific Range of IP Addresses to Connect”

12. PORT X Serial Settings

- a. To access this screen, click the “Next” button or click the Port X Serial link on the left side of the screen. X = The Serial Port number (1 - 4).
- b. This screen allows you to change the serial port settings.

3. Setup and Connections

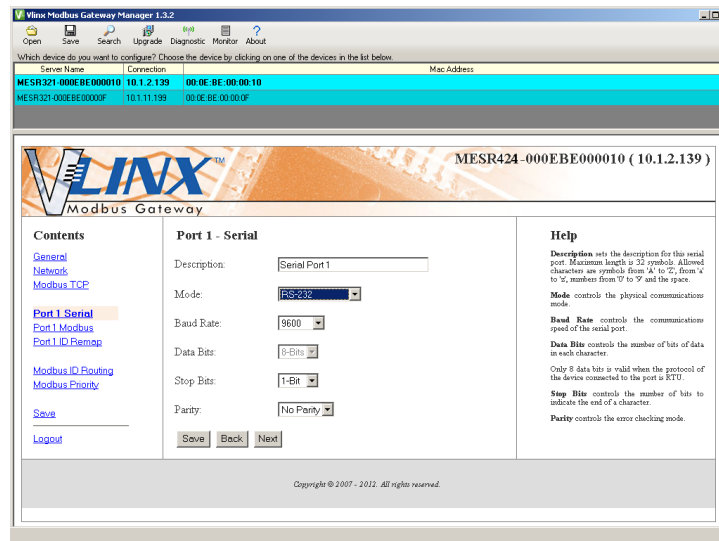

Figure 37. Serial Port Screen

- c. Description - sets the description for this serial port. Maximum length is 32 symbols. Allowed characters are symbols from 'A' to 'Z', from 'a' to 'z', numbers from '0' to '9' and the space.
 - d. Mode – Controls the physical communications mode for the. The Mode can be RS-232, RS-422 (4-Wire), RS-485 (2-Wire), or RS-485 (4-Wire).
 - e. Baud Rate – Controls the communications speed of the serial port. The Baud Rate can be 75, 150, 300, 600, 1200, 2400, 4800, 7200, 9600, 14.4k, 19.2k, 14.4k, 28.8k, 38.4k, 57.6k, 115.2k, or 230.4k.
 - f. Stop Bits – Controls the number of bits to end a character. Choices are 1 or 2.
 - g. Parity – Controls the error checking mode. Choices are Odd, Even, Mark, or Space.
 - h. Save settings by clicking the “Save” button.
13. Port X Modbus
- a. To access this screen, click the “Next” button or click the “Port X Modbus” Link on the left side of the screen. X = The Serial Port Number (1 - 4).
 - b. This screen allows you to change the Modbus settings for the port.

3. Setup and Connections

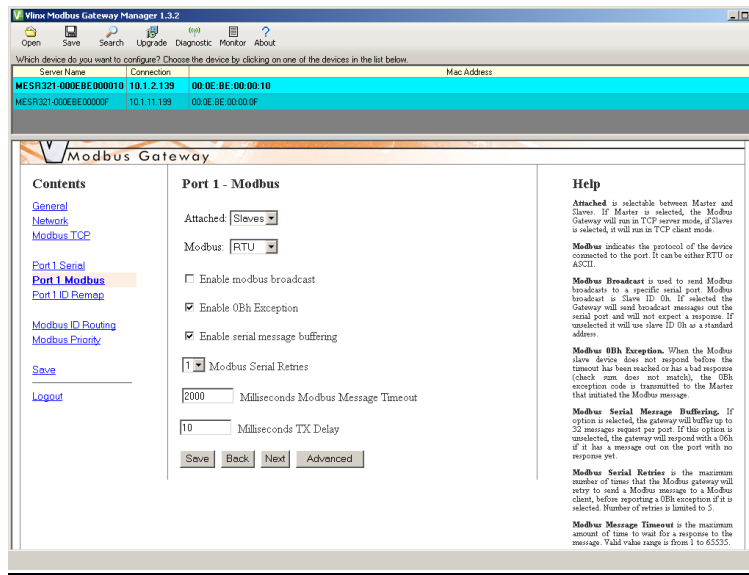

Figure 38. Modbus Port Screen

- c. Attached – This is selectable between Master and Slaves. If Master is selected, the Modbus Gateway will run in TCP server mode, if Slaves is selected, it will run in TCP client mode.
- d. Modbus – indicates the protocol of the device connected to the port. It can be either RTU or ASCII.
- e. Modbus Broadcast – Check this box to send Modbus broadcasts to a specific serial port. Modbus broadcast is Slave ID 0h. If selected the Gateway will send broadcast messages out the serial port and will not expect a response. If unselected it will use slave ID 0h as a standard address.
- f. Enable 0Bh Exception – Check this box to enable. When the Modbus slave device does not respond before the timeout has been reached or has a bad response (check sum does not match), the 0Bh exception code is transmitted to the Master that initiated the Modbus message.
- g. Enable Serial Message Buffering – If this option is selected, the gateway will buffer up to 32 messages request per port. If this option is unselected, the gateway will respond with a 06h if it has a message out on the port with no response yet.
- h. Modbus Serial Retries – Select 0 through 5. This sets the maximum number of times that the Modbus gateway will retry to send a Modbus message to a Modbus client, before reporting a 0Bh exception if it is selected. Number of retries is limited to 5.
- i. Milliseconds Modbus Message Timeout – This is the maximum amount of time to wait for a response to the message. Valid value range is from 1 to 65535.

3. Setup and Connections

- j. Milliseconds TX Delay – This is the minimum amount of time after receiving a response before the next message can be sent out. Valid value range is from 1 to 65535.
 - k. Save settings by clicking the “Save” button.
14. Port x ID Remap
- a. To access this screen, click the “Next” button or click the “Port x ID Remap” link on the left side of the screen.
 - b. This screen allows you to set Modbus Slave ID Remap settings.

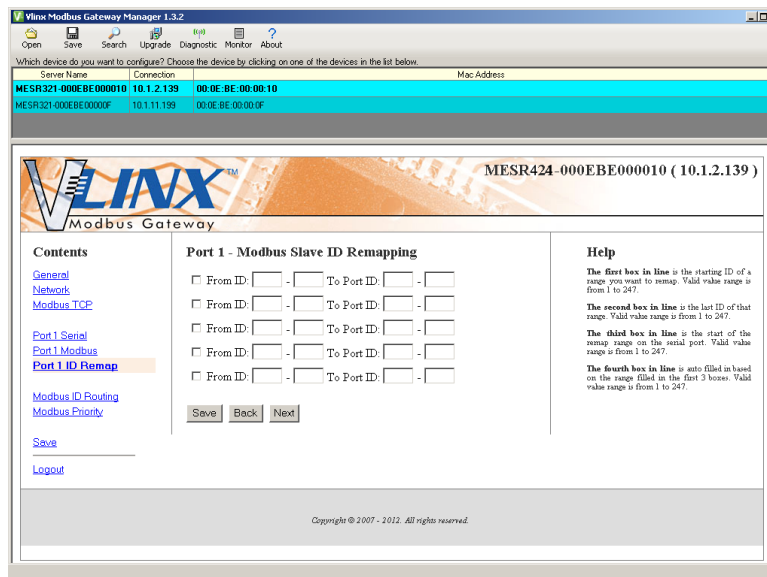

Figure 39. Port ID Remap Screen

- c. The first box in line is the start of the remap range on the serial port you want to remap. Valid value range is from 1 to 247.
 - d. The second box in line is the last serial port of that range. Valid value range is from 1 to 247.
 - e. The third box in line is the starting ID of a range to remap to. Valid value range is from 1 to 247.
 - f. The fourth box in line is auto filled in based on the range filled in the first 3 boxes. Valid value range is from 1 to 247.
 - g. Save settings by clicking the “Save” button.
15. Modbus ID Routing
- a. To access this screen click the “Next” button or click the “Modbus ID Routing” Link on the left side of the screen.

3. Setup and Connections

- b. This screen allows you to set the Modbus Slave ID routing.

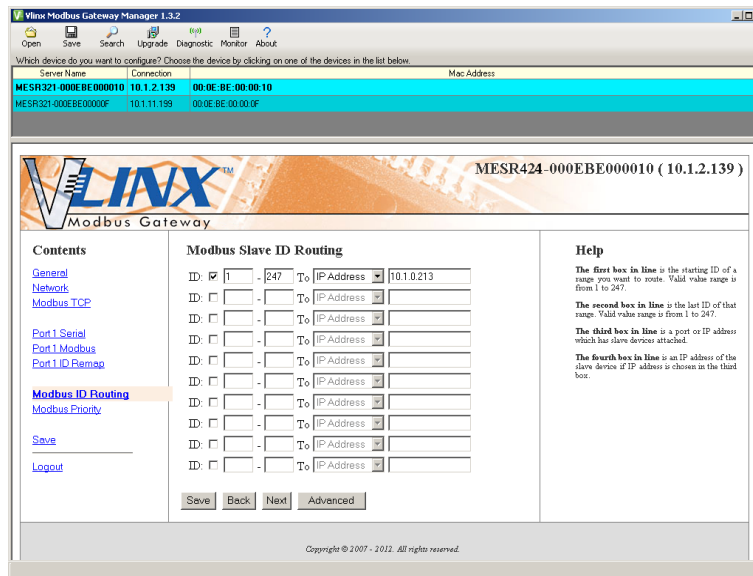

Figure 40. Modbus ID Routing Screen

- c. The first box in line is the starting ID of a range you want to route. Valid value range is from 1 to 247.
- d. The second box in line is the last ID of that range. Valid value range is from 1 to 247.
- e. The third box in line is a port or IP address which has slave devices attached.
- f. The fourth box in line is an IP address of the slave device if IP address is chosen in the third box.
- g. Save settings by clicking the “Save” button.

16. Modbus Priority

- a. To access this screen, click the “Next” button or click the “Modbus Priority” link on the left side of the screen.
- b. This screen allows you to configure the gateway to move high priority messages to the front of the serial message buffer.

3. Setup and Connections

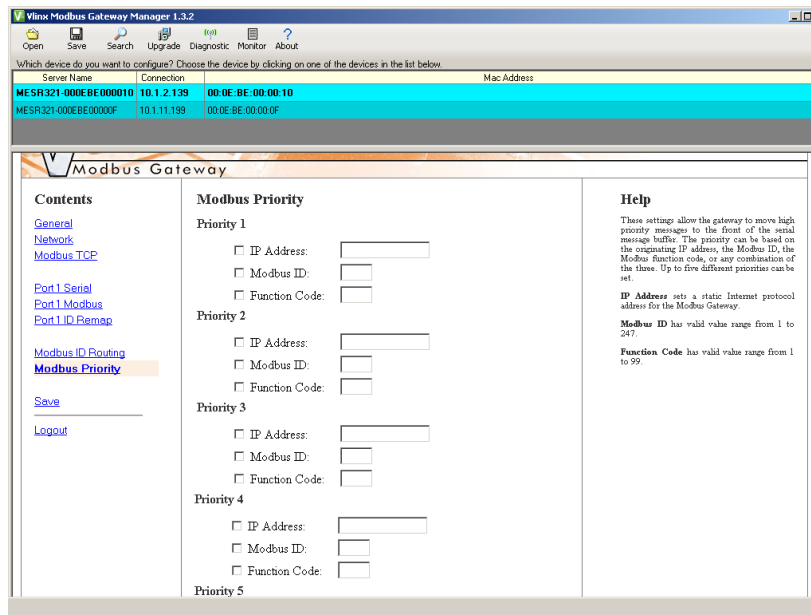

Figure 41. Modbus Priority Screen

- c. These settings allow the gateway to move high priority messages to the front of the serial message buffer. The priority can be based on the originating IP address, the Modbus ID, the Modbus function code, or any combination of the three. Up to five different priorities can be set.
 - d. IP Address – Used to set a static Internet protocol address for the Modbus Gateway.
 - e. Modbus ID – Valid range is from 1 to 247.
 - f. Function Code – Valid range is from 1 to 99.
- Save settings by clicking the “Save” button.

Configuring with the Web Interface

MESR424 Modbus Gateways can be configured over the network using a standard internet browser such as Internet Explorer or Firefox.

To open the web configuration interface:

1. On a PC connected to the network, open a web browser.

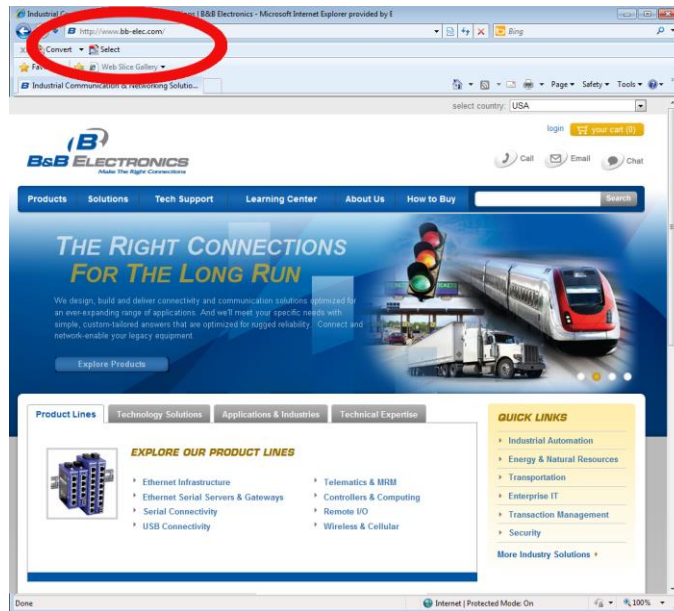

Figure 42. Open Web Browser

2. In the browser's address bar, type the IP address of the Modbus gateway.

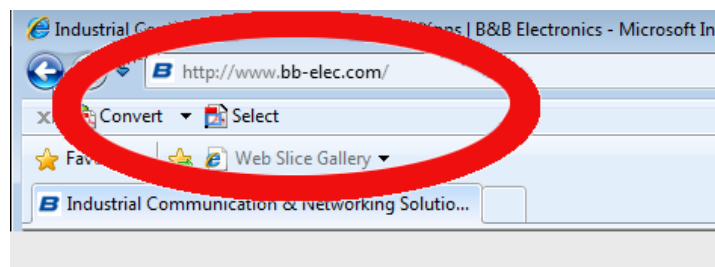

Figure 43. Type IP Address

Note: Your Modbus gateway comes from the factory pre-configured to receive an IP address assignment from a DHCP server. If a DHCP Server is not available on your network, it will default to 169.254.102.39.

3. Setup and Connections

The web interface Login page appears.

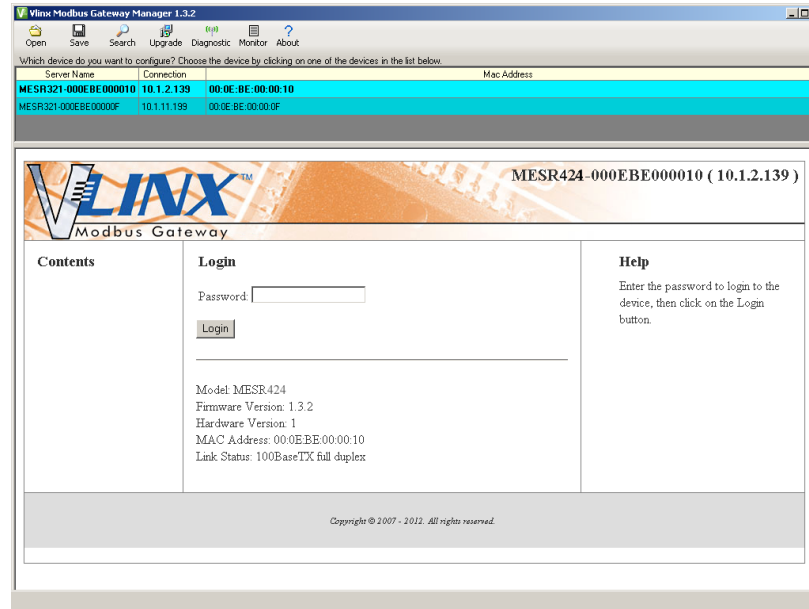

Figure 44. Modbus Gateway Login Screen

3. The screens for configuring your gateway using a web browser are the same as those used to configure using the Vlinx Modbus Manager software.

Configuring the MESR424 Modbus Gateway on Networks without a DHCP Server

Your MESR424 Modbus Gateway comes from the factory set up to receive an IP assignment from a DHCP Server. If there is not a DHCP server on your network, the Modbus Gateway will default to IP address **169.254.102.39**. If this address does not work with your PC, there are two methods to manually configure the network information.

1. Method 1: Change your PC Network to Match the Modbus Gateway
 - a. Open your network connection

3. Setup and Connections

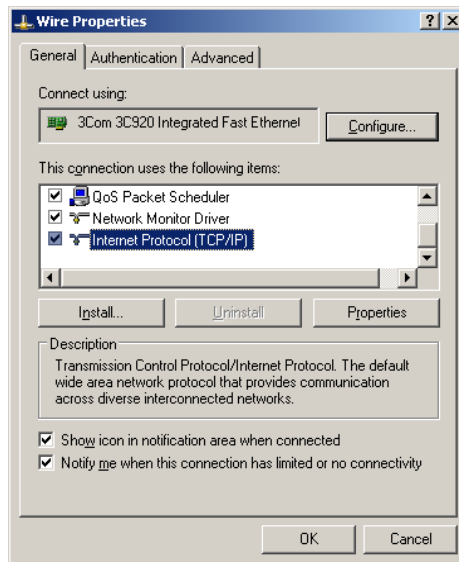

- b. Click on Internet Protocol (TCP/IP) and click the Properties button. Change the parameters to the following:

IP Address = 169.254.102.1

Subnet Mask = 255.255.0.0

Default Gateway = 169.254.102.100

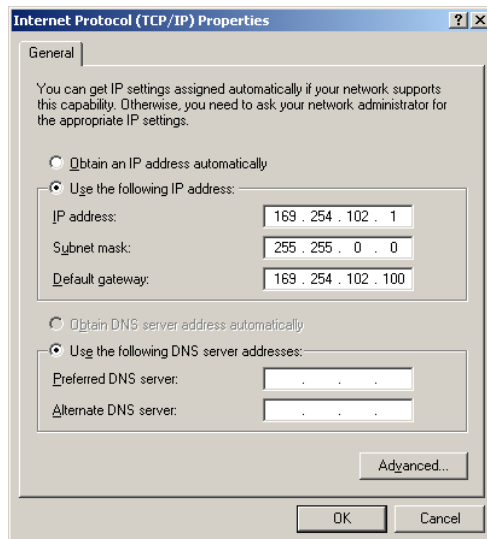

- c. Use the Vlinx Modbus Manager Software to search for, discover, and configure the Modbus Gateway.

2. Method 2: Change the Modbus Gateway's network settings to match your PC using Console Mode

3. Setup and Connections

- a. Connect a null modem serial cable (crossover cable) from port 1 on the Modbus Gateway to an available COM port on your PC.
- b. Enter Console Mode. Press and hold the Modbus Gateway's Mode/Reset switch for 2 to 10 seconds. The LED indicators will respond as follows:

Port LED	Ready LED
OFF	ON
OFF	OFF

- c. Release the Mode/Reset button. The READY LED will blink once per second for five seconds. This indicates that the Modbus Gateway is re-booting in Console Mode.
- d. When the Modbus Gateway has successfully restarted in Console Mode, the READY LED will be OFF and the PORT 1 LED will be ON.
- e. Open the Vlinx Modbus Manager Software and select "Serial Port" as the method to connect to the Modbus Gateway.
- f. After logging in, click on <Network>.
- g. Un-check the box next to "I Want DHCP to setup the Network."
- h. Re-configure the Modbus Gateway's network settings to something within the range of your PC's network settings. For example:

PC Network Settings

IP Address = 192.168.0.1

Subnet Mask = 255.255.0.0

Default Gateway = 192.168.0.100

Change the Modbus Gateway's network settings to:

IP Address = 192.168.0.50

Subnet Mask = 255.255.0.0

Default Gateway = 192.168.0.100

- i. Save the settings and remove power from the Modbus Gateway.
- j. Re-apply power. Open the Vlinx Modbus Manager Software and select "Network" as the method to connect to the device.

Configuring the MESR424 Modbus Gateway via the Serial Port (Console Mode)

Your Modbus gateway can be configured via a serial port using Vlinx Modbus Manager. To use this feature the Modbus gateway's serial port must be connected to the serial port of a PC (using a null modem cable).

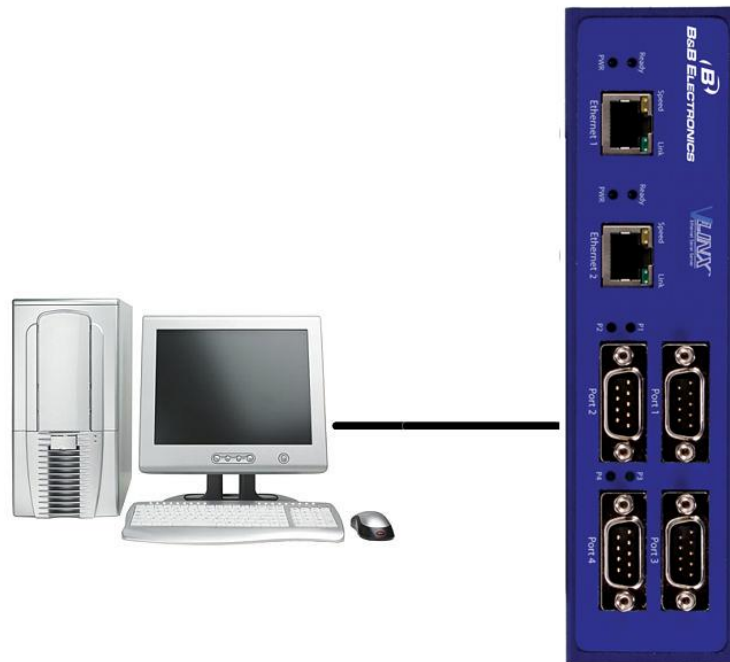

Figure 45. Console Mode Setup

To configure the Modbus gateway it must be put into Console Mode, using the Mode/Reset switch.

To enter Console Mode, press and hold the Mode/Reset switch for between two and ten seconds. The LED indicators respond as follows:

1. The Ready LED blinks three times per second while the button is being pressed.
2. **To configure the Modbus gateway**, open the Vlinx Modbus Manager software and set up the Modbus gateway's parameters as required.
2. Under Connection, select "Serial Port."

3. Setup and Connections

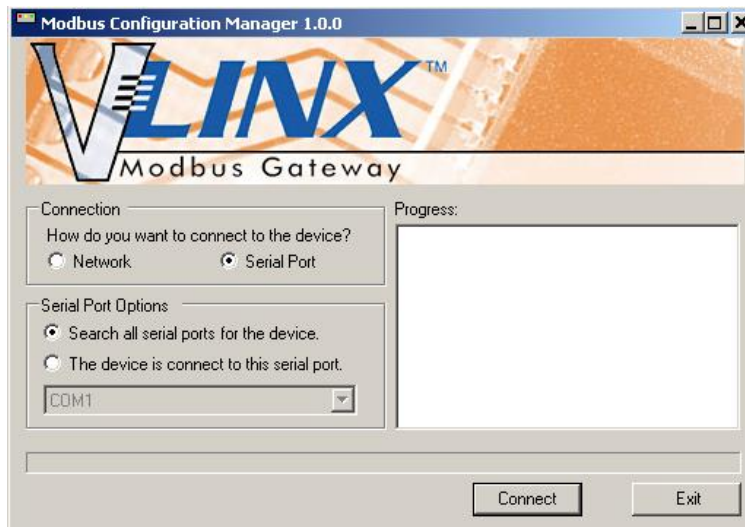

Figure 46. Connection

3. If you do not know which COM port your gateway is connect to, select “Search all serial ports for the device” under Serial Port Options. If you do know, you may specify the COM port by selecting “The device is connected to this serial port” under Serial Port Options and using the pull down menu to choose the COM port.

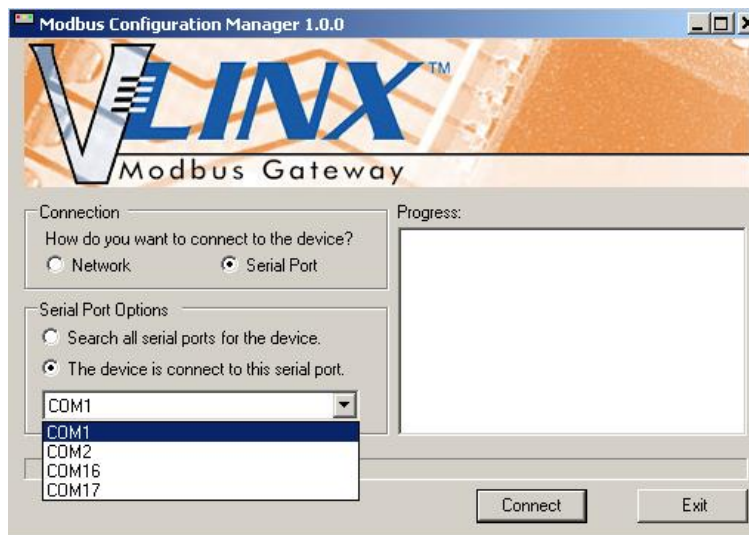

Figure 47. Serial Port Selection

4. The remaining screens are identical to those shown in configuring your gateway using a [network connection](#).

To exit Console Mode, press and hold the Mode/Reset switch for two seconds.

The LEDs go back to their normal states when the device resumes normal operation.

MESR424 Modbus Gateway Operational Connections

MESR424 Modbus Gateways can operate in Direct IP Mode.

Using MESR424 Modbus Gateways in Direct IP Mode

A Direct IP connection allows applications using TCP/IP socket programs to communicate with the COM ports on the Modbus gateway. In this type of application the Modbus gateway is configured as a TCP server. The socket program running on the PC establishes a communication connection with the Modbus gateway. The data is sent directly to and from the serial port on the server.

To set up a Direct IP Mode connection:

1. Connect the Modbus gateway to the network and a Modbus network as described in previous sections.
2. Configure the Modbus gateway with the appropriate network settings (using Vlinx Vlinx Modbus Manager or the web interface).
3. Configure your software application with the appropriate IP address and port number to communicate with the Modbus network(s).

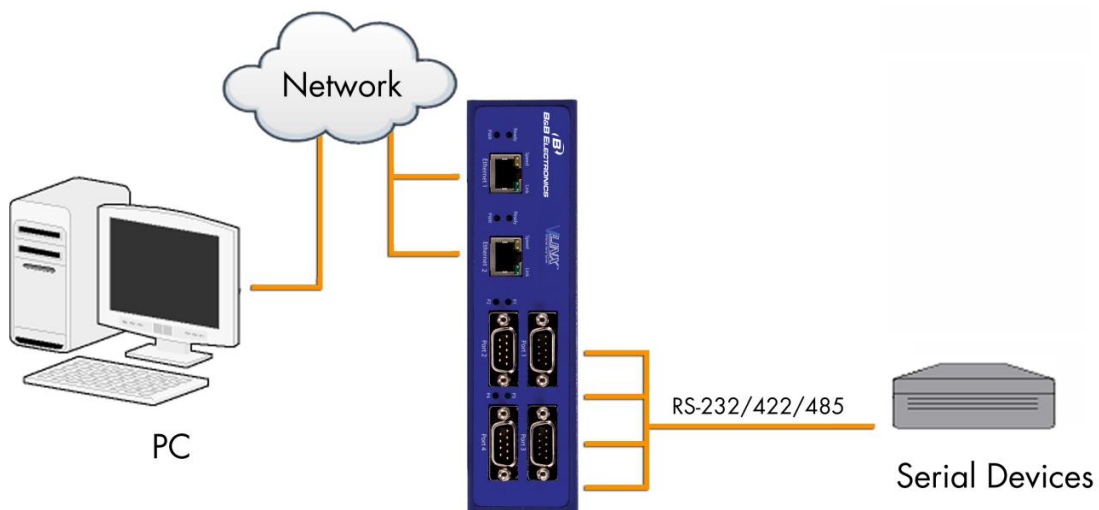

Figure 48. Direct IP Connection

Initiating a Hardware Reset on the Modbus Gateway

To initiate a Hardware Reset on the Modbus gateway, press the Mode/Reset switch for less than two seconds, and release it. The LED indicators respond as follows:

1. The Ready LED blinks three times per second while the button is being pressed.
2. The Modbus gateway is in Reset Mode when Port 1 LED is On and the Ready LED is Off.
3. The LEDs go back to their normal states when the device resumes normal operation.

Reloading Factory Defaults

To reload Factory Defaults, press and hold the Mode/Reset switch for more than 10 seconds. The LED indicators respond as follows:

1. The Ready LED blinks three times per second while the button is being pressed.
2. The Modbus gateway reloads all factory default configuration parameters.
3. The LEDs go back to their normal states when the device resumes normal operation.

Note: Factory default parameters are listed in Appendix A

4. Upgrading the Firmware

Occasionally, updated firmware may become available for your Modbus gateway. The firmware can be upgraded using the Zlinx Manager software. The following procedure describes the firmware updating process:

1. Click the **Upgrade** button to open the **Firmware Upgrade** dialog box.

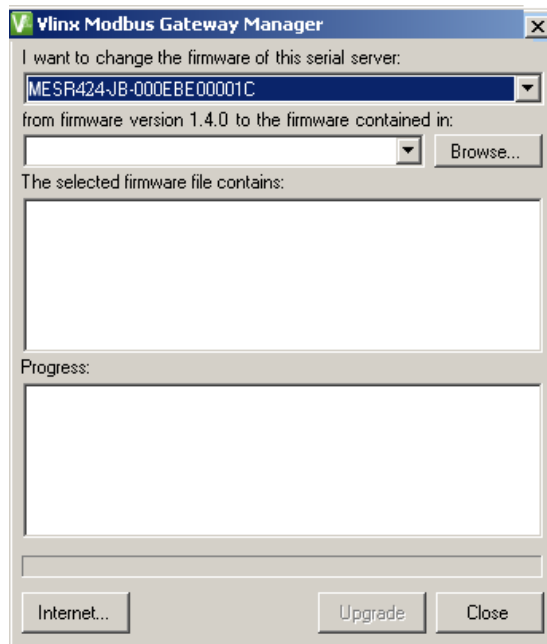

Figure 49. Firmware Upgrade Dialog Box

The name of the currently selected Modbus gateway appears in the top drop down list. Other Modbus gateways (that have already been discovered) can be selected from the drop down list, if desired.

The current firmware version of the selected Modbus gateway is shown in the text below the Modbus gateway name.

Information about the selected firmware file is shown in the third text box.

Downloading Firmware Files

The **Firmware File** list (second box) displays all firmware files in the firmware installation folder. Only firmware that is compatible with the selected Modbus gateway is available in this list.

To download the latest firmware files from an FTP site on the Internet:

1. Click the **Internet** button at the bottom of the window.

The Vlinx Modubs Manager connects to an FTP server on the Internet.

2. Click the **Check for Updates** button.

Progress Bar and **Progress Box** display information about and progress of the download.

To download the latest firmware files from a file:

1. Click the **Browse** button to open an **Open File** dialog box.
2. Browse to the drive and folder containing the firmware file.
3. Select and download the file to the local firmware folder.

Uploading the Firmware to the Modbus Gateway

To upgrade the firmware:

1. In the **Modbus Gateway Selection** drop down list, select the Modbus gateway to be upgraded.
2. In the **Firmware Description** drop down list, select the firmware to upload to the Modbus gateway.
3. Click the **Upgrade** button.

Progress Bar and **Progress Box** provides information on the progress of the transfer.

4. In the **Firmware File** drop down list, select the firmware file to upload to the Modbus gateway.
5. Click **Upgrade**.

The Progress box and Progress bar display information on the upgrading process.

6. When the upgrade process is complete, click **Close**.

5. Diagnostics

Clicking the **Diagnostics** icon opens the **Diagnostics** dialog box and enables you to check the operation of connected Modbus gateways on the local computer.

The **Computer Information** box displays information about the type of network connections, the IP addresses, Subnet Masks and Default Gateways in use.

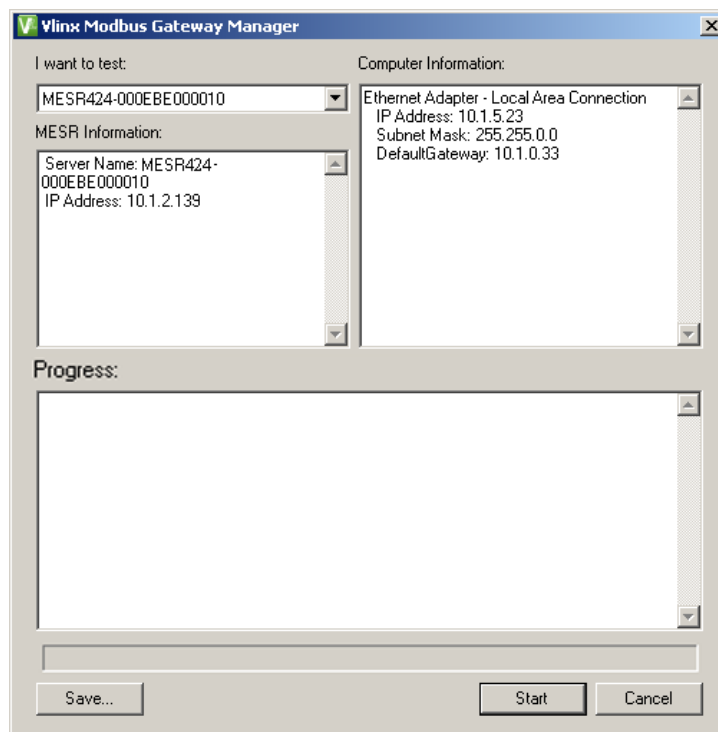

Figure 50. Diagnostics Dialog Box

Testing a Modbus Gateway Connection

To run diagnostics on a Modbus gateway:

1. Click the **Diagnostics** icon.
The **Diagnostics** dialog box appears.
2. In the drop down box select the specific Modbus gateway you want to check.
3. Click the **Start** button

Information about the progress of the pinging process is displayed in the **Test Progress** box.

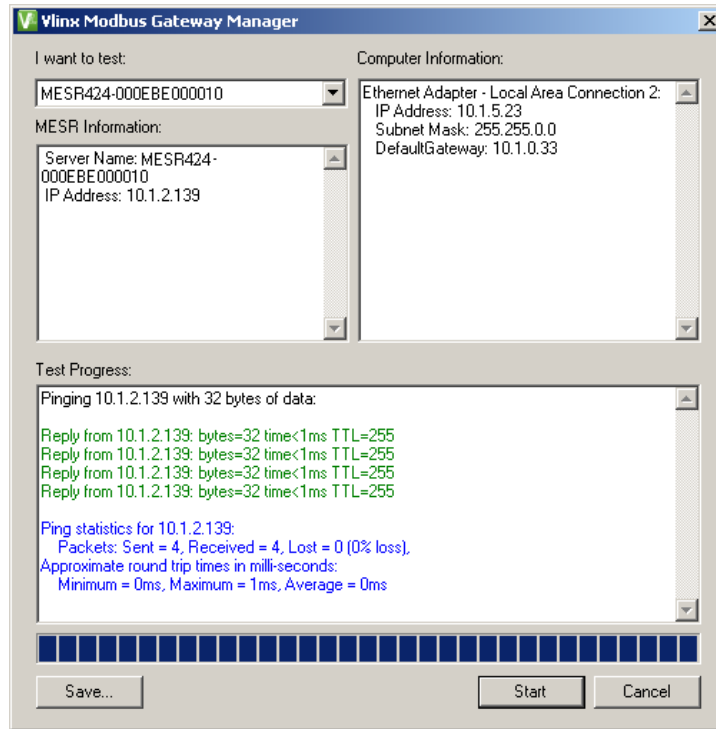

Figure 51. Testing a Modbus Gateway Connection

Monitor Function

The Monitor button is used to display a screen that shows information about events and data transfer through the Modbus Gateway.

To start monitoring, select a Modbus Gateway and press the **“Start”** button.

The **“Auto Scroll”** check box enables and disables automatic scrolling of the displayed text.

The **“Clear”** button clears the displayed text.

Press the **“Stop”** button to stop monitoring.

Press the **“Save”** button to save the information to a file.

6. Application Examples

Modbus gateways can be used to integrate Modbus networks in a wide variety of settings. But as each setting has its own requirements, users may not understand how a gateway helps, or if it's appropriate for their specific needs.

The following scenarios are examples only, and many others are possible. Contact B&B Electronics technical support for information on other applications.

Ethernet Master and Serial Slaves

Your Modbus gateway can be used to integrate serial slave devices on a Modbus TCP network. This allows TCP Masters to control serial slave devices. The example below is using a gateway with two serial ports.

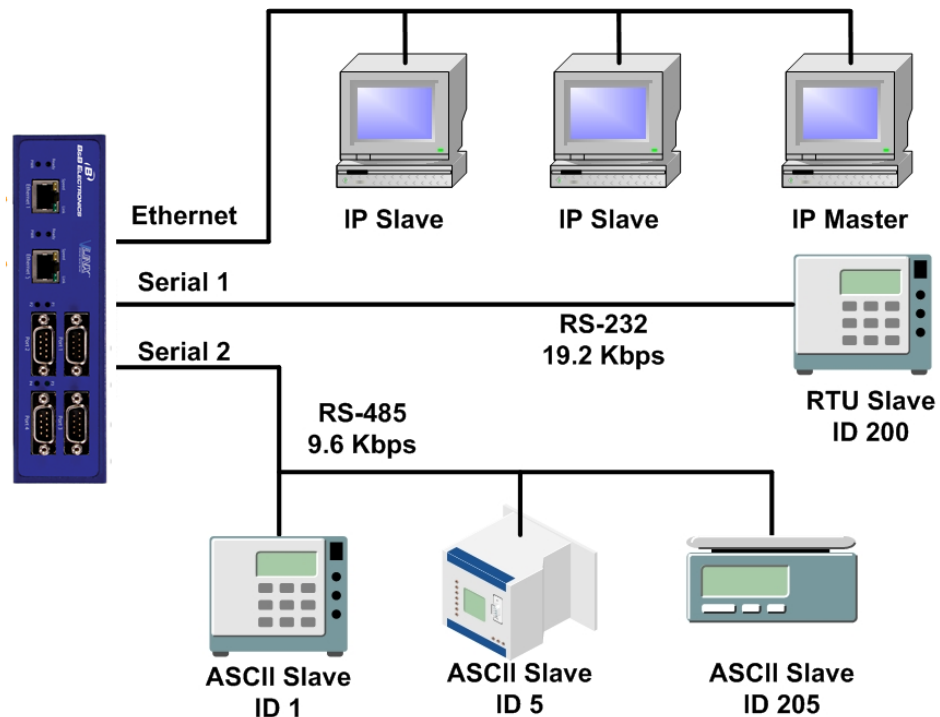

Figure 52. Ethernet Master With Serial Slaves

5. Log into your gateway.

6. Application Examples

6. Access the serial port one setup screen by clicking the link on the left side of the screen.

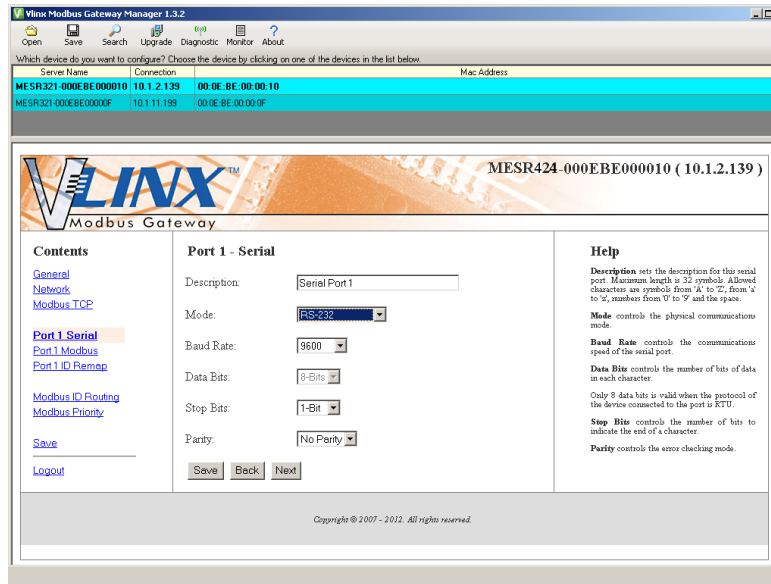

Figure 53. Serial Port 1 Setup

7. Configure Serial Port 1. In this case it is RS-232, 19.2 kbps, 8 data bits, 1 stop bit, and even parity. Save the settings.
8. Access Port 1 Modbus by clicking the link on the left side of the screen.

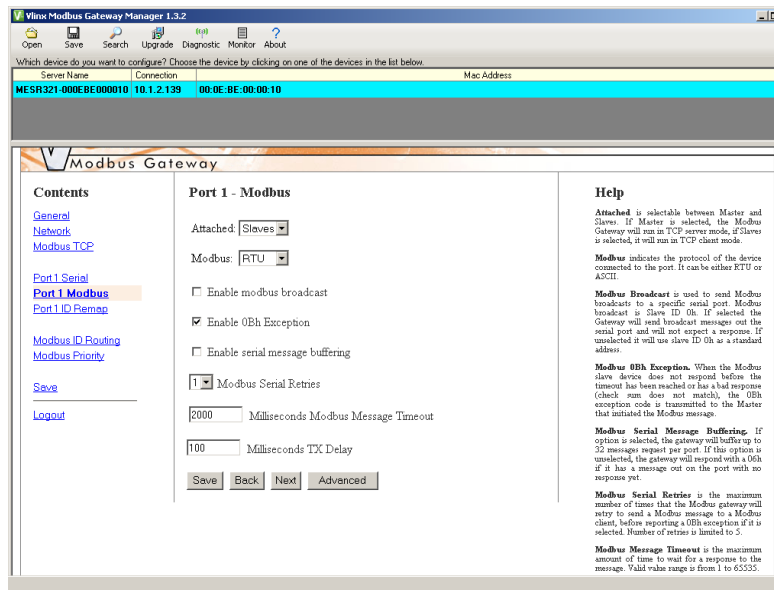

Figure 54. Port 1 Modbus

6. Application Examples

- Configure the Port 1 Modbus Settings. In this case Attached should be slaves, Modbus should be RTU. The other settings depend on your application.
- Configure Port 2 Serial and Modbus in the same fashion.
- Access Modbus ID Remapping for each port and configure as necessary.

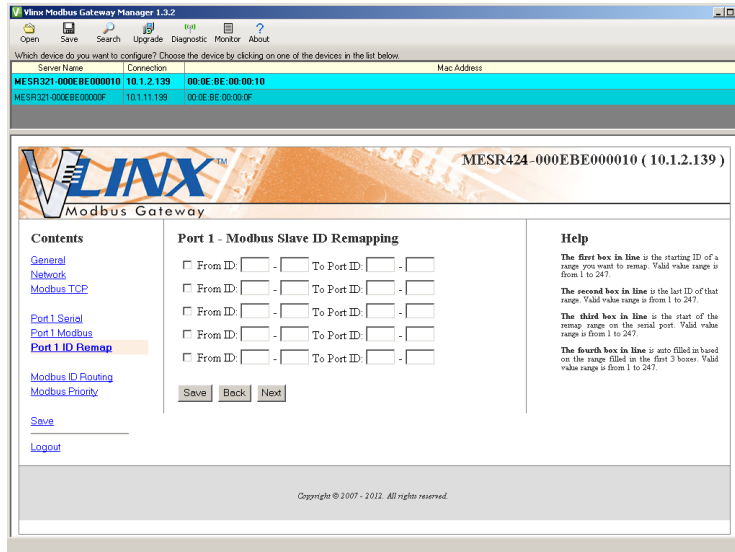

Figure 55. Port x Modbus Slave ID Remapping

- Access Modbus ID Routing. Configure as necessary. In this example, Slave ID 200 is mapped to serial port 1, Slave ID 1 through 5 and 205 are mapped to serial port 2.

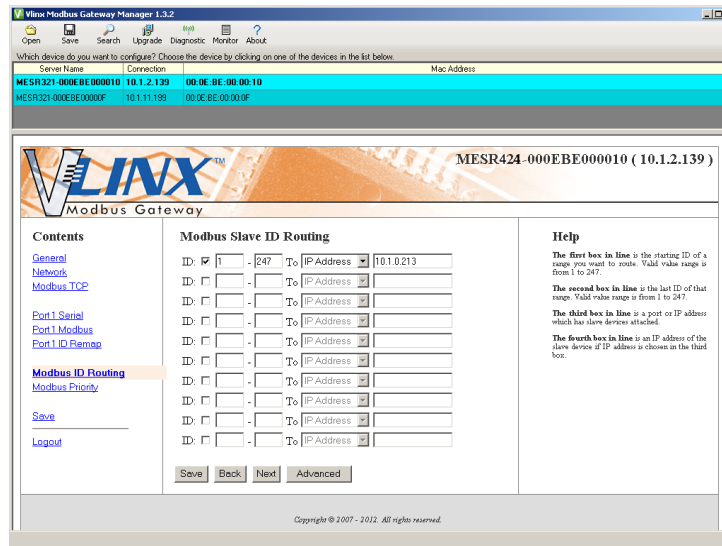

Figure 56. Modbus ID Routing

6. Application Examples

13. Access Modbus Priority and configure as necessary.

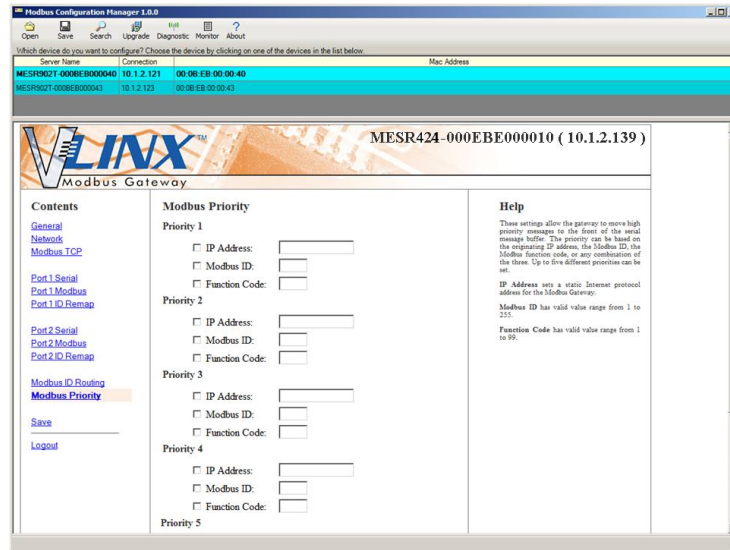

Figure 57. Modbus Priority

Serial & Ethernet Masters, Serial & Ethernet Slaves

Your Modbus Gateway can also integrate multiple master devices onto serial and Ethernet Networks.

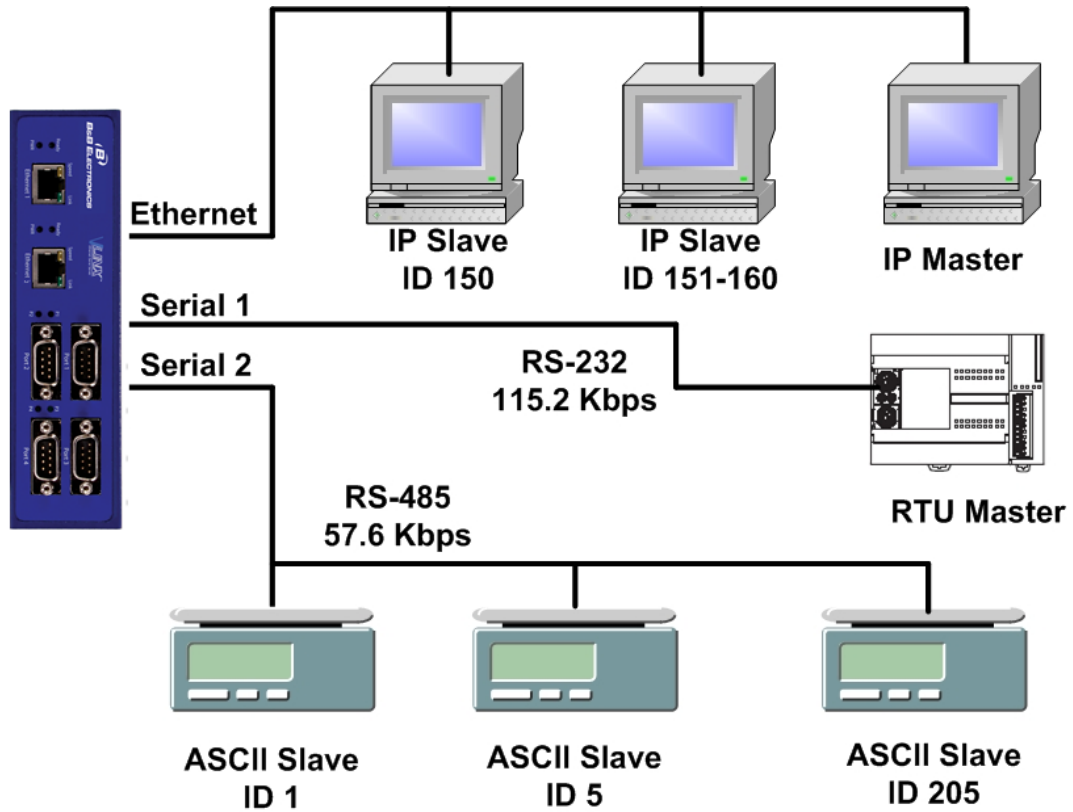

Figure 58. Serial & Ethernet Masters, Serial & Ethernet Slaves

1. In this example, Serial Port 1 has an RTU Master attached. Configure the serial port settings as appropriate for the device. Access the Port 1 Modbus screen and configure it the port for Modbus Master and RTU.

6. Application Examples

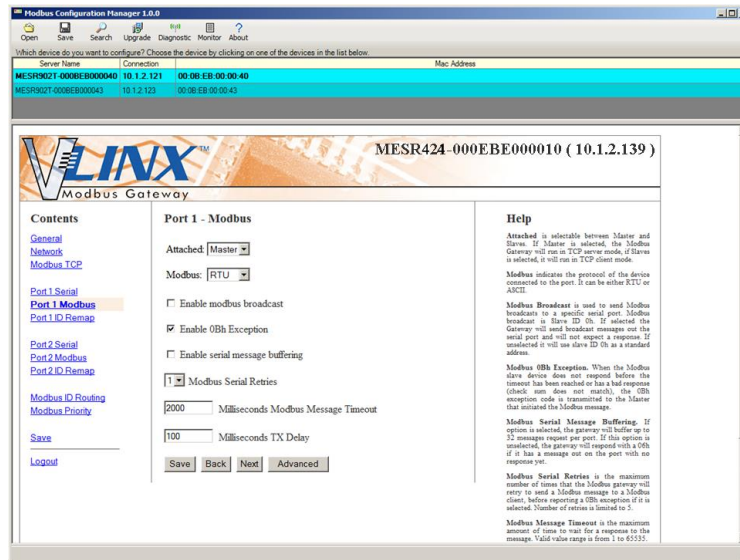

Figure 59. Port 1 Modbus

- Configure the Modbus Slave ID routing. In this case Modbus Slaves 1 through 5 and 205 are on Serial Port 2. Modbus Slaves 150 and 151 through 160 have IP assignments.

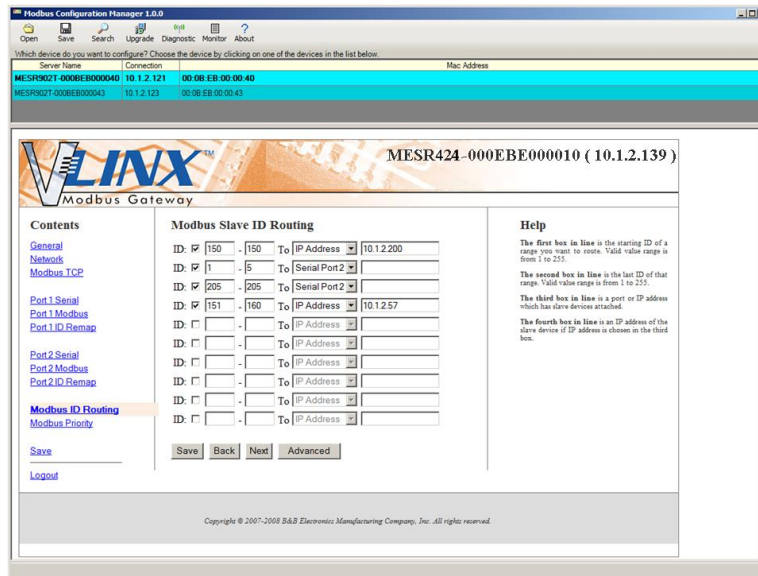

Figure 60. Modbus Slave ID Routing

Serial Masters, IP Slaves

Serial Masters can be used to control IP Slaves.

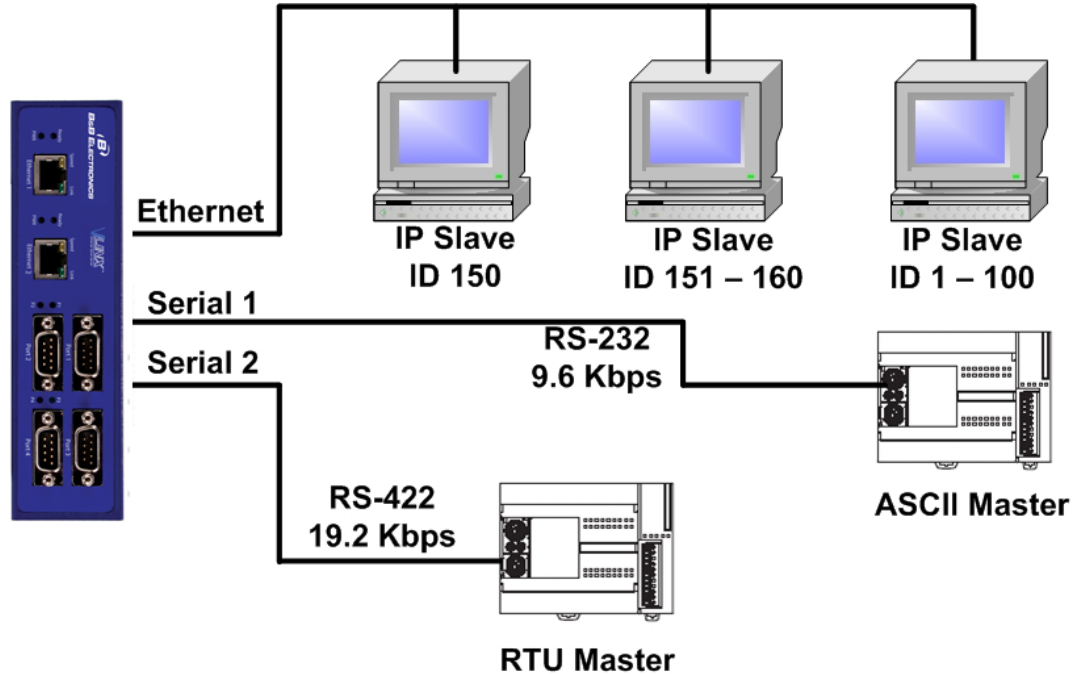

Figure 61. Serial Masters, IP Slaves

1. In this example, an ASCII Master is connected to Serial Port 1 and an RTU Master is connected to Serial Port 2. Configure the serial ports as appropriate for these devices.

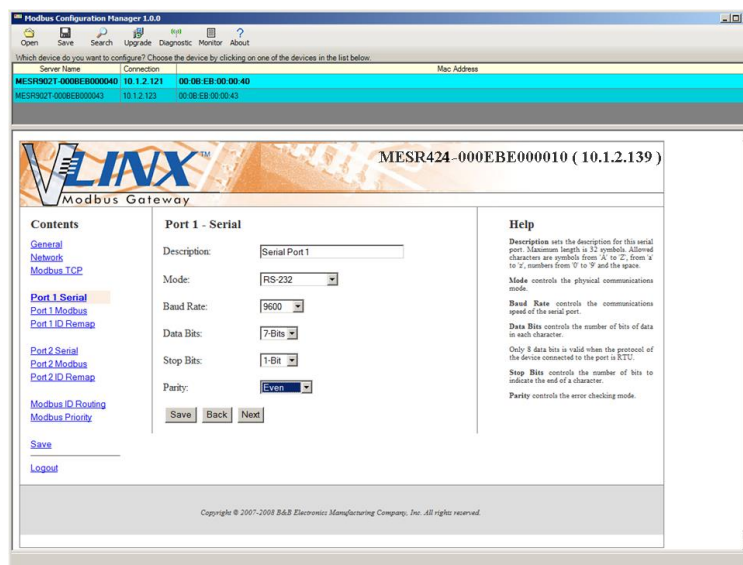

Figure 62. Port 1 Serial

6. Application Examples

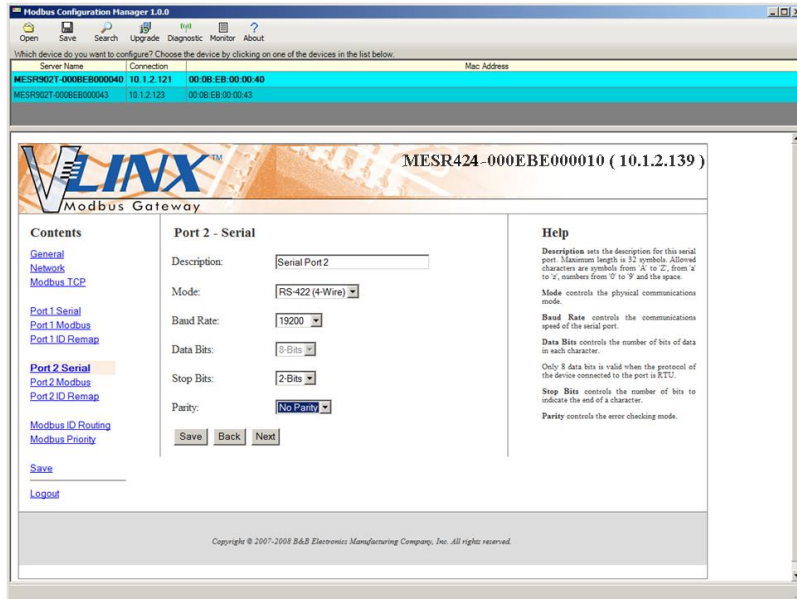

Figure 63. Port 2 Serial

2. Access the Modbus screen for each port and configure as appropriate. In this case, Port 1 has an ASCII Master and Port 2 has an RTU Master attached.

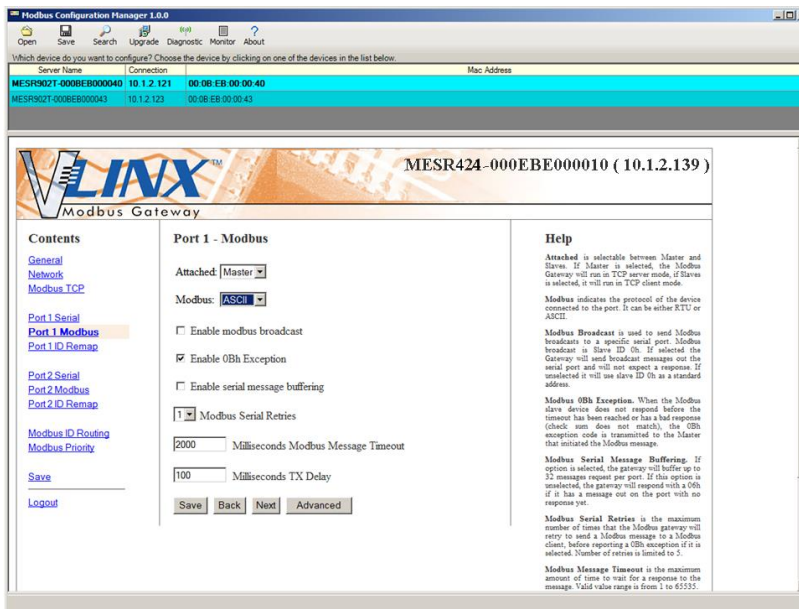

Figure 64. Port 1 Modbus

6. Application Examples

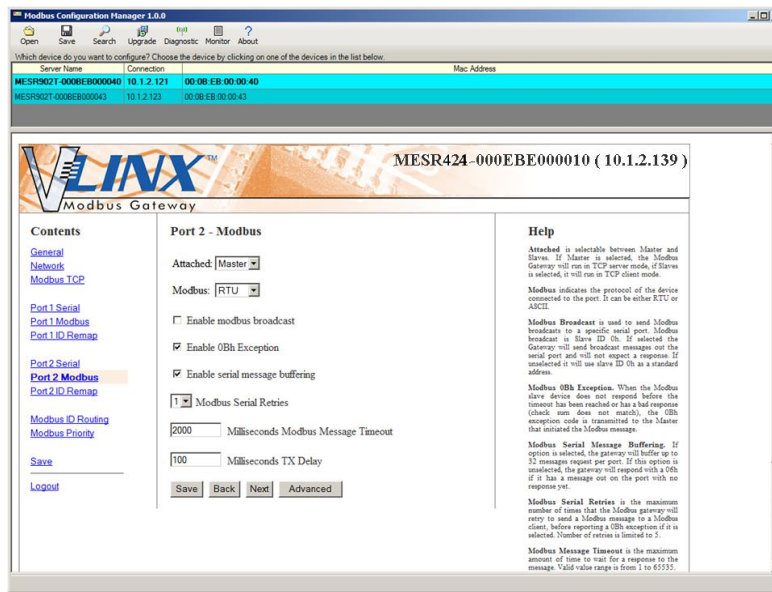

Figure 65. Port 2 Modbus

3. Setup the Slave ID Routing to associate IP addresses with the appropriate Slave ID.

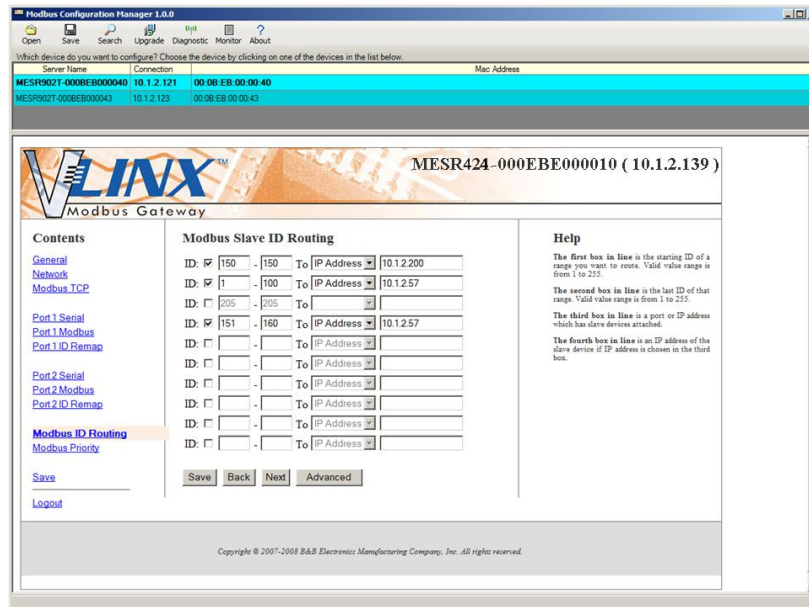

Figure 66. Modbus Slave ID Routing

Serial Masters, IP Slaves

Serial Masters can be used to control IP Slaves.

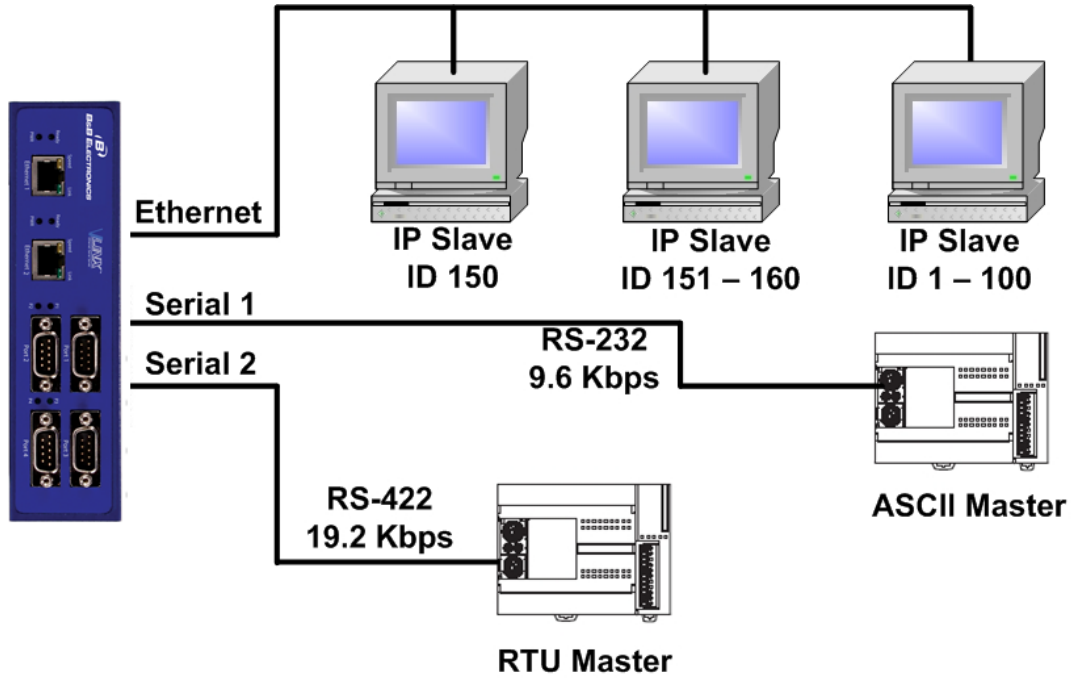

Figure 67. Identical Hard Coded Slaves

Serial Masters, IP Slaves

Serial Masters can be used to control IP Slaves.

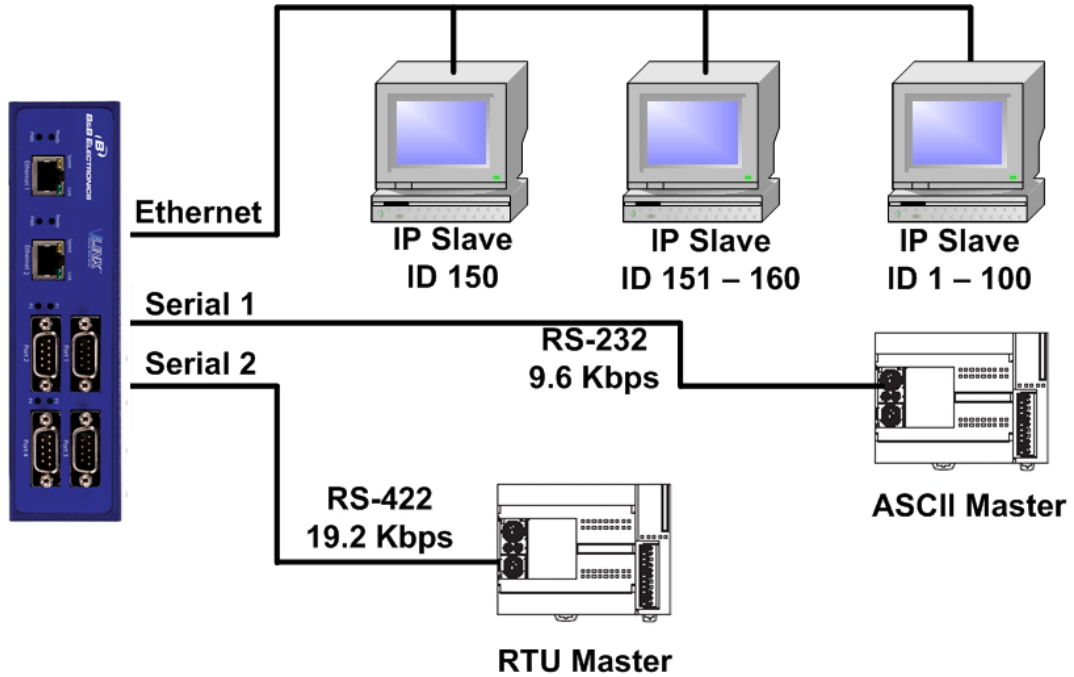

Figure 68. Identical Production Lines

7. Modbus Help

Modbus ASCII/RTU Basics

The Modbus protocol emerged in the mid-1970s as an early protocol for linking terminals with Modicon PLCs using a master/slave (sometimes called a master/client) relationship. A simple, open, message-based protocol, it caught on quickly and became a de facto standard in the industry. It supports asynchronous point-to-point and multidrop communications and can be used with a variety of serial interfaces (RS-232, RS-422, RS-485, modems, etc).

The original Modbus specification included two possible transmission modes: ASCII and RTU. Modbus RTU mode is the most common implementation, using binary coding and CRC error-checking. Modbus ASCII messages, though somewhat more readable because they use ASCII characters, is less efficient and uses less effective LRC error checking. ASCII mode uses ASCII characters to begin and end messages whereas RTU uses time gaps (3.5 character times) of silence for framing. The two modes are incompatible so a device configured for ASCII mode cannot communicate with one using RTU.

All Modbus communications are initiated by Modbus masters using a polling query/response format. The master can send broadcast messages (using a slave address of 0), which all slaves accept, but do not reply to. More commonly the master polls individual slaves sequentially. In each poll it sends a message containing a **device address**, followed by a **function code**, any **data** that maybe required, and an **error check** field. The addressed slave responds with a similar message structure. Typically it repeats back its address and the function code, and then sends a field indicating the number of bytes of data it is sending, followed by the data and the error check field.

Slave addresses can range from 1 to 247. Function codes include several common ones typically used in all applications, and additional ones that may be implemented in specific cases. Common function codes include: Read Coil Status (01), Read Input Status (02), Read Holding Registers (03) and Read Input Registers (04).

When a master sends a message to a slave it expects to receive a valid response within certain length of time. If the slave does not receive the message, or if the slave receives the message but an error is detected, it does not respond. If the slave cannot respond appropriately for some other reason (e.g. it does not recognize the function code), it will return a message containing an exception response.

Hints and Tips

A few simple suggestions that may assist you if your system is experiencing problems include:

- Slowing down the polling rate may be helpful if power cycling doesn't cure the problem.
- A common misperception is that every serial network must terminate with a resistor. While this was true of early serial network configurations, it's typically the wrong answer – call our technical support and verify if you're an exception, at 815.433.5100 option 3.

A sometimes difficult problem is difference in grounding voltage between various network locations. Stray voltage from lightning or other sources may also find its way onto the network. These conditions make isolation necessary in many settings.

8. Appendices

This section includes the following Appendices:

- Appendix A: Default Gateway Settings
- Appendix B: Product Specifications
- Appendix C: Dimensional Diagrams
- Appendix D: Connector Pinouts

Appendix A: Default Gateway Settings

Setting	Default Value
Gateway Name	User assigned
Password	password field is blank from factory
DHCP	Enabled
IP Address	DHCP will configure. If a DHCP Server is not available, the unit will default to 169.254.102.39
Net Mask	255.255.0.0
Gateway	169.254.1.1
MAC Address	Fixed - see bottom label
Port	1, 2, 3, 4
Serial port mode	RS-485
Baud Rate	9600
Data bits	8
Parity	None
Stop bits	1
Flow Control	None
Protocol	TCP
Serial timeout	0 seconds
Inter-character timer	0 ms
TCP port	502
Max connection	1

Appendix B: Product Specifications

This section includes the following specifications:

- General Specifications
- Controls, Indicators and Connector Specifications
- Serial Interface Specifications
- Network Specifications

General Specifications

Hardware and included accessories	Device	MESR424 Modbus gateway module
	CD	CD with Vlinx Modbus Manager software for Windows XP (32/64 bit), 2003 Server (32/64 bit), Vista (32/64 bit), 2008 Server (32/64 bit), Windows 7 (32/64 bit)
Optional Accessories	Cable	232NM9 Null Modem Crossover Cable for DTE to DTE connection
	Rail	ERS35 one-meter length of steel 35mm DIN Rail
Configuration Options	Via serial port	Using Vlinx Modbus Manager via a serial connection, press Mode/Reset button to enter Console Mode
	Via network	Using Vlinx Modbus Manager via an Ethernet connection Using a standard web browser such as Internet Explorer or Firefox
Software	Vlinx Modbus Manager for Modbus gateway configuration	Windows XP (32/64 bit), 2003 Server (32/64 bit), Vista (32/64 bit), 2008 Server (32/64 bit), Windows 7 (32/64 bit)
Environment	Operating Temperature	-40 to 80 °C (-40 to 176 °F)
	Storage Temperature	-40 to 85 °C (-40 to 185 °F)
	Operating Humidity	10 to 95% non-condensing
Certifications	FCC	Part 15 Class A
	UL	Class 1, Div. 2 Groups A, B, C, D
	CE	
	TS2	
Enclosure	Rating	IP30
	Mounting	DIN rail mount (35 mm)
	Dimensions, Medium Case	1.2 x 4.5 x 6.2 in (2.8 x 11.4 x 15.7 cm)
Terminal Blocks	Wire Size	28 to 16 AWG
	Wire Type	Copper Wire Only
	Tightening Torque	5 KG-cm
	Wire Temp Rating	105°C Minimum, Sized for 60°C Ampacity
	Note	One conductor per terminal

Power Supply Specifications

Power Supply (External Supply Required)	Voltage Requirements	10 to 48 VDC (58 VDC Max)
	Power Consumption	6.0W (Max)
	Locking barrel connector input:	Voltage requirements: 10 to 30 VDC maximum Class 2 grounded type supply only.

NOTE: Coaxial power cable must be in accordance with Class 2 requirements in Article 725 of the NEC. The locking barrel connector must NOT be used in a hazardous environment.

Controls, Indicators and Connector Specifications

Switches	Mode/Reset button	Hold in for 0 to 2 seconds for hardware reset Hold in for 2 to 10 seconds for Console Mode/Reset (Do a hardware reset or recycle power to exit Console Mode) Hold in for more than 10 seconds to reset to factory defaults
Indicators	Serial LED (one per port)	Color = Green Blink = Data traffic
	Link LED	Color = Green On = 100BaseTX Off = 10BaseT Blink = Data traffic
	Ready LED	Color = Green Blink (once per second) = System OK Off = System NOT OK
Connectors	10BaseT/100BaseTX Ethernet	RJ-45F (8 pin)
	SC fiber	SC connector
	ST fiber	ST connector
	Serial	4 DB-9M or terminal block connectors
	DC Power	5.08mm 2-position pluggable, lockable terminal block

Serial Interface Specifications

Mode Selection	RS-232/422/485 software selectable
RS-232 lines	TXD, RXD, RTS, CTS, DTR, DSR, DCD, GND
RS-422 lines (4 wire)	TXDA(-), TXDB(+), RXDA(-), RXDB(+), GND
RS-485 lines (2 wire)	Data(-), Data(+), GND
RS-485 lines (4 wire)	TXDA(-), TXDB(+), RXDA(-), RXDB(+), GND
Baud Rates	75, 150, 300, 600, 1200, 2400, 4800, 7200, 9600, 14.4k, 19.2k, 28.8k, 38.4k, 57.6k, 115.2k, 230.4k
Data Bits	7, 8
Parity	None, even, odd, mark, space
Stop bits	1, 2
RS-422/485 biasing	Auto 1 K ohm pullups and pulldowns
RS-485 data control	Auto control via MCU

Network Specifications

Memory	Serial Memory	8 K-bytes per port
	Network Memory	8 K-bytes
TCP Ports	80	Web Server
	502	Modbus client/server port – user configurable
	7000	TCP Configuration
	10000	Monitor Port
UDP Ports	7000	UDP Configuration
	8899	Device Discovery
Network Communications	LAN	10/100 Mbps Auto-detecting 10BaseT or 100BaseTX
Network Physical Layer Standards	Ethernet	IEEE 802.3 auto-detecting & auto MDI/MDX 10BaseT, 100BaseTX and 100BaseFX
Protocols Supported		TCP, IPv4, ARP, HTTP 1.0, ICMP/PING, DHCP/BOOTP
	IP Mode	Static, DHCP or Auto IP
Connection Modes	TCP	User definable
		Server, Client,
Search		Serial direct COM and Ethernet auto search or specific IP
Firmware Upgrade		Via serial, Ethernet or auto web search
Timeouts	Modbus Message	1 to 65535 ms, default set at 2,000 ms
	TX Delay	1 to 65535 ms, default set at 10 ms
	Custom Timeouts	
	Inter-character	100 to 5000 ms, default set at 0 – user to set if enabled
	Inter-message	100 to 5000 ms, default set at 0 – user to set if enabled

Appendix D: Connector Pinouts

DB9 Serial Port Pinouts

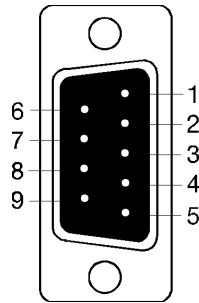

DB9 M Pin	Direction	RS-232
1	Input	DCD
2	Input	RXD
3	Output	TXD
4	Output	DTR
5	---	GND
6	Input	DSR
7	Output	RTS
8	Input	CTS
9	No Connection	

Terminal Block Serial Port Pinouts

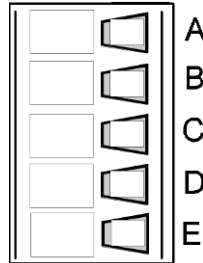

Terminal	RS-232	Direction (RS-232)	RS-422	RS-485
A	RTS	Output	TDA (-)	Data A (-)
B	TD	Output	TDB (+)	Data B (+)
C	CTS	Input	RDA (-)	---
D	RD	Input	RDB (+)	---
E	GND	---	GND	GND

In the RS-422 mode, TX lines are outputs and RX lines are inputs. Connect the Modbus gateway TXB(+) line to the RXB(+) line of the Modbus network, and the Modbus gateway TXA(-) to the RXA(-) of the Modbus network.

Ground is signal ground and provides a common mode reference for the RS-422 Receiver and Transmitters.