

Description: FPC 2.4G antenna

Series: Internal Antenna

PART NUMBER: W3921XXXXX



Features:

- 2400-2500MHz FPC dipole
- Efficiency >50%
- Gain +1dBi
- 100mm cable length and U.FL compatible connector as standard setup, P/N W3921B0100
- Custom configurations upon request

Applications:

- Bluetooth, Zigbee, WiFi, BLE
- ISM 2.4GHz band radios
- Set top boxes,
- Security
- Transportation

All dimensions are in mm / inches

Issue: 1725

In the effort to improve our products, we reserve the right to make changes judged to be necessary.

CONFIDENTIAL AND PROPRIETARY INFORMATION

This document contains confidential and proprietary information of Pulse Electronics, Inc. (Pulse) and is protected by copyright, trade secret and other state and federal laws. Its receipt or possession does not convey any rights to reproduce, disclose its contents, or to manufacture, use or sell anything it may describe. Reproduction, disclosure or use without specific written authorization of Pulse is strictly forbidden.

For more information:

Pulse Worldwide Headquarters
15255 Innovation Drive #100
San Diego, CA 92128
USA
Tel: 1-858-674-8100

Pulse/Larsen Antennas
18110 SE 34th St Bldg 2 Suite 250
Vancouver, WA 98683
USA
Tel: 1-360-944-7551

Europe Headquarters
Pulse GmbH & Do, KG
Zeppelinstrasse 15
Herrenberg, Germany
Tel: 49 7032 7806 0

Pulse (Suzhou) Wireless Products Co, Inc.
99 Huo Ju Road(#29 Bldg,4th Phase
Suzhou New District
Jiangsu Province, Suzhou 215009 PR China
Tel: 86 512 6807 9998



Description: FPC 2.4G antenna

Series: Internal Antenna

PART NUMBER: W3921XXXXX

This document covers all product variants of the following product family:

W3921B0039	39mm 1.13mm OD cable	U.FL compatible connector
W3921B0050	50mm 1.13mm OD cable	U.FL compatible connector
W3921B0100	100mm 1.13mm OD cable	U.FL compatible connector
W3921T0150	150mm 0.81mm OD cable	W.FL compatible connector

Issue: 1725

In the effort to improve our products, we reserve the right to make changes judged to be necessary.

CONFIDENTIAL AND PROPRIETARY INFORMATION

This document contains confidential and proprietary information of Pulse Electronics, Inc. (Pulse) and is protected by copyright, trade secret and other state and federal laws. Its receipt or possession does not convey any rights to reproduce, disclose its contents, or to manufacture, use or sell anything it may describe. Reproduction, disclosure or use without specific written authorization of Pulse is strictly forbidden.

Description: FPC 2.4G antenna

Series: Internal Antenna

PART NUMBER: W3921XXXXX

ELECTRICAL SPECIFICATIONS

Frequency	2400-2500MHz
Nominal Impedance	50Ω
VSWR	< 2
Gain	1dBi +/- 1 dB
Efficiency	50%
Radiation Pattern	Omni
Polarization	Linear
Power withstanding	2 W

(*) All RF parameters measured on 2mm thick PC plate

Issue: 1725

In the effort to improve our products, we reserve the right to make changes judged to be necessary.

CONFIDENTIAL AND PROPRIETARY INFORMATION

This document contains confidential and proprietary information of Pulse Electronics, Inc. (Pulse) and is protected by copyright, trade secret and other state and federal laws. Its receipt or possession does not convey any rights to reproduce, disclose its contents, or to manufacture, use or sell anything it may describe. Reproduction, disclosure or use without specific written authorization of Pulse is strictly forbidden.

Description: FPC 2.4G antenna

Series: Internal Antenna

PART NUMBER: W3921XXXXX

MECHANICAL SPECIFICATIONS

PCB type	Flexible
Radiator size	33[1.3] x 7.7[0.3] mm[inch]
Adhesive	3M467
Total thickness (Radiator + adhesive)	0.1[0.004] mm[inch]
Weight	about 0.37 g
Cable type	OD 1.13mm/0.81mm coax cable
Cable length	Optional mm[inch]
Connector	U.FL/W.FL compatible

ENVIRONMENTAL SPECIFICATIONS

Operating temperature	-40/+85° C
-----------------------	------------

Description: FPC 2.4G antenna

Series: Internal Antenna

PART NUMBER: W3921XXXXX

MECHANICAL DRAWING

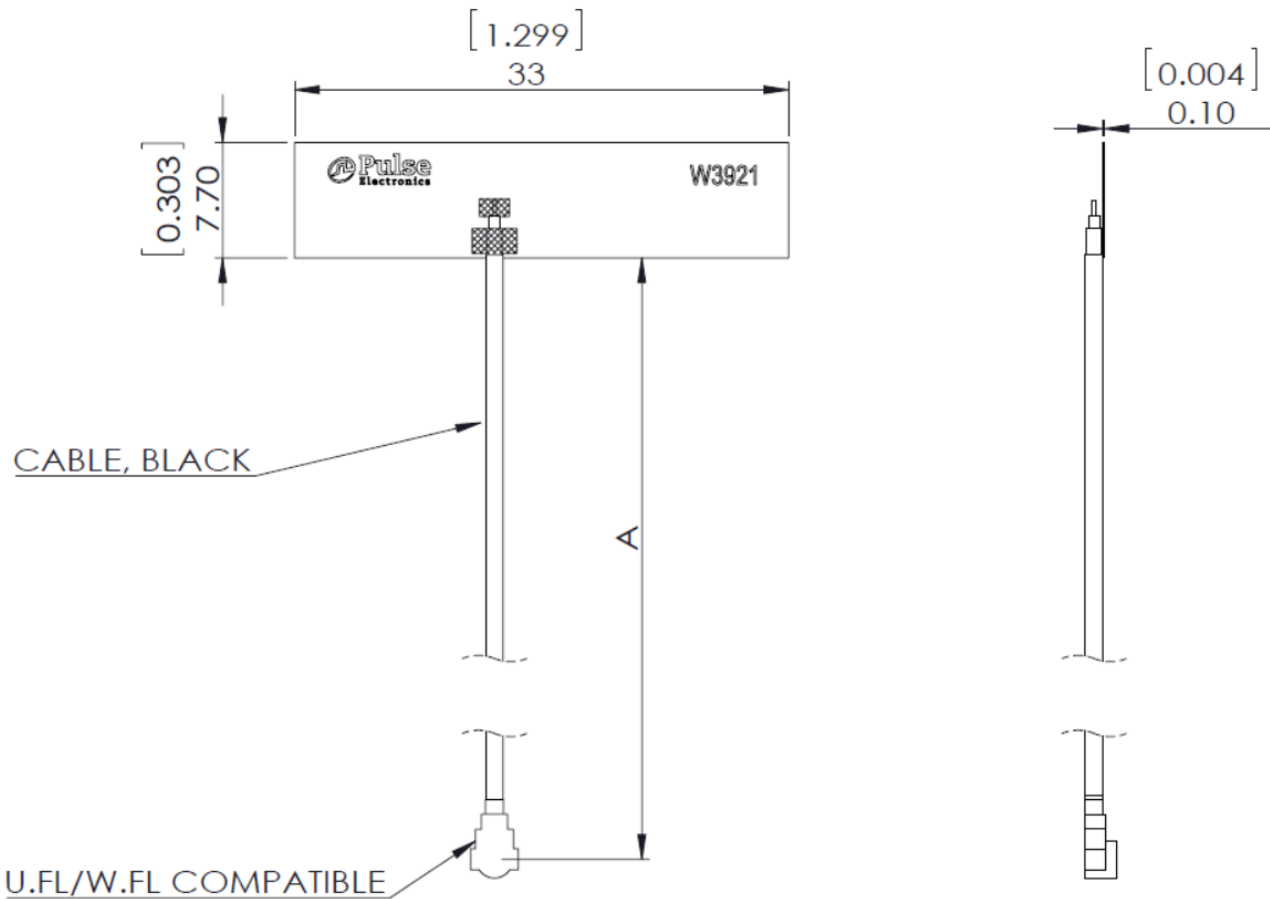

ITEM	PROJECT NAME	A LENGTH(MM)	CABLE P/N	CABLE DIAMETER	CONNECTOR
1	W3921B0050	50	055-2248.001	1.13MM	U.FL COMPATIBLE
2	W3921B0100	100	055-2248.002	1.13MM	U.FL COMPATIBLE
3	W3921T0150	150	055-2248.003	0.81MM	W.FL COMPATIBLE
4	W3921B0039	39	055-2248.004	1.13MM	U.FL COMPATIBLE

Issue: 1725

In the effort to improve our products, we reserve the right to make changes judged to be necessary.

CONFIDENTIAL AND PROPRIETARY INFORMATION

This document contains confidential and proprietary information of Pulse Electronics, Inc. (Pulse) and is protected by copyright, trade secret and other state and federal laws. Its receipt or possession does not convey any rights to reproduce, disclose its contents, or to manufacture, use or sell anything it may describe. Reproduction, disclosure or use without specific written authorization of Pulse is strictly forbidden.

Description: FPC 2.4G antenna

Series: Internal Antenna

PART NUMBER: W3921XXXXX

CHARTS

(* All RF parameters measured on 2mm thick PC plate

Return Loss

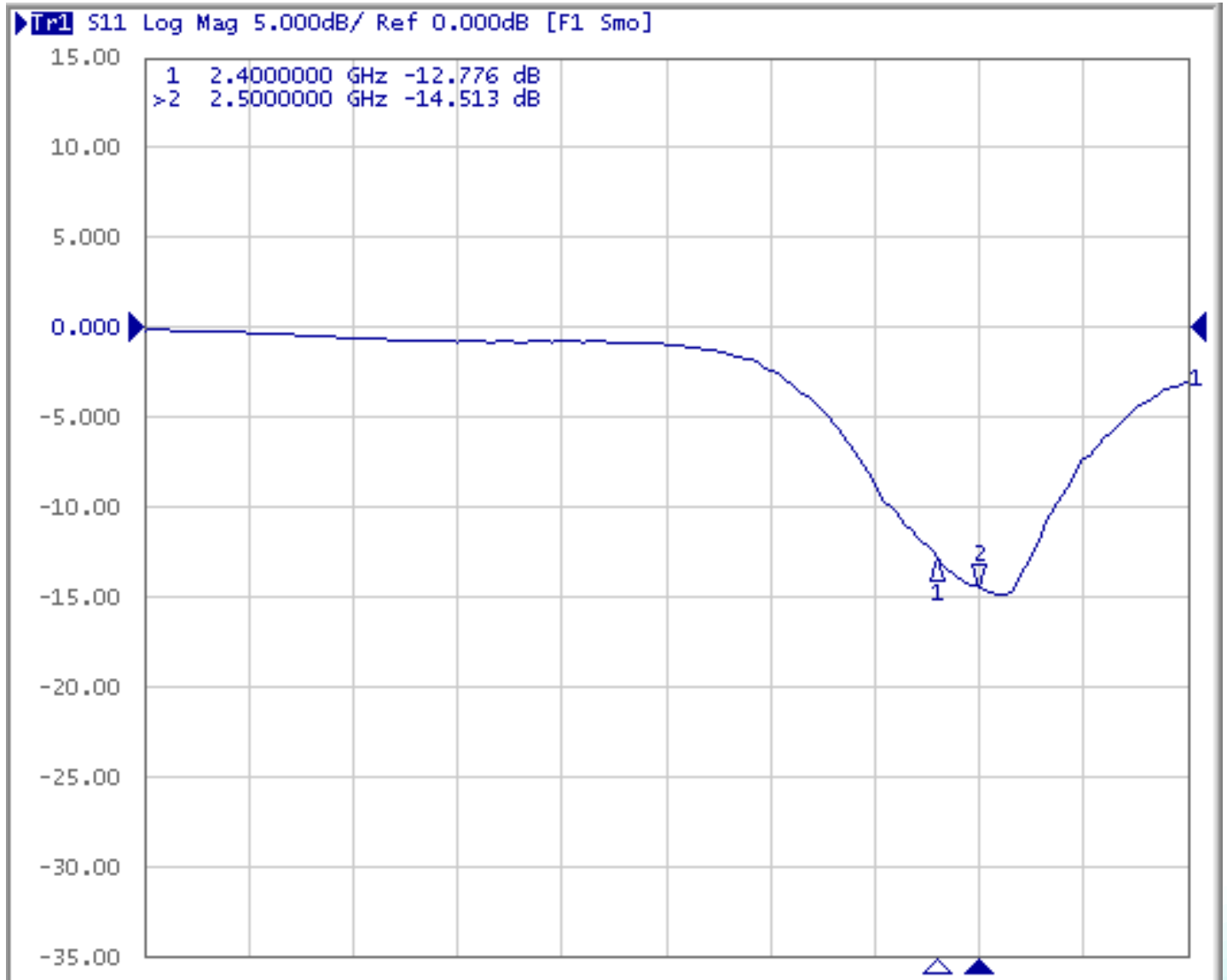

Issue: 1725

In the effort to improve our products, we reserve the right to make changes judged to be necessary.

CONFIDENTIAL AND PROPRIETARY INFORMATION

This document contains confidential and proprietary information of Pulse Electronics, Inc. (Pulse) and is protected by copyright, trade secret and other state and federal laws. Its receipt or possession does not convey any rights to reproduce, disclose its contents, or to manufacture, use or sell anything it may describe. Reproduction, disclosure or use without specific written authorization of Pulse is strictly forbidden.

Description: FPC 2.4G antenna

Series: Internal Antenna

PART NUMBER: W3921XXXXX

CHARTS

(*) All RF parameters measured on 2mm thick PC plate

VSWR

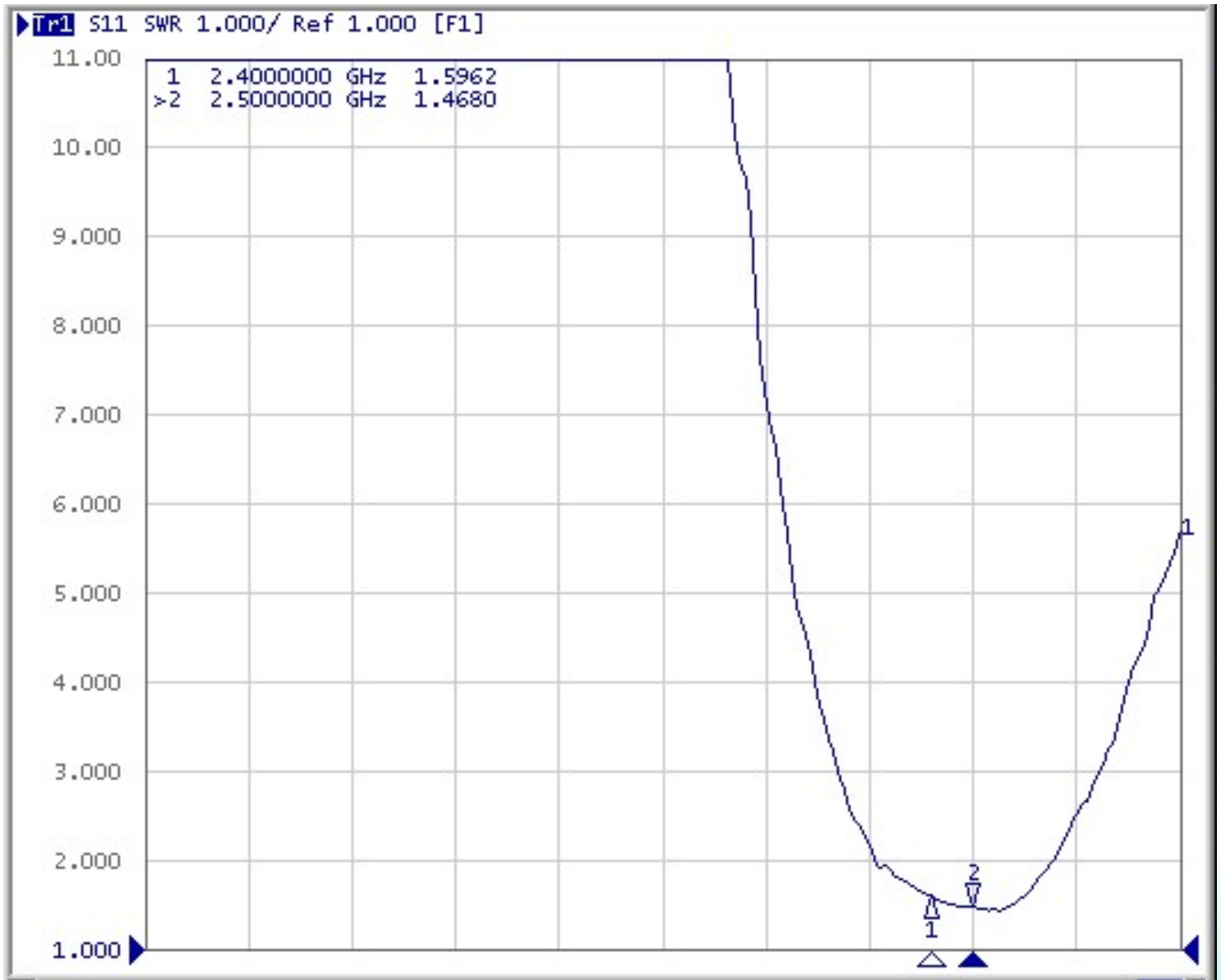

Issue: 1725

In the effort to improve our products, we reserve the right to make changes judged to be necessary.

CONFIDENTIAL AND PROPRIETARY INFORMATION

This document contains confidential and proprietary information of Pulse Electronics, Inc. (Pulse) and is protected by copyright, trade secret and other state and federal laws. Its receipt or possession does not convey any rights to reproduce, disclose its contents, or to manufacture, use or sell anything it may describe. Reproduction, disclosure or use without specific written authorization of Pulse is strictly forbidden.

Description: FPC 2.4G antenna

Series: Internal Antenna

PART NUMBER: W3921XXXXX

CHARTS

(* All RF parameters measured on 2mm thick PC plate
Efficiency(%) & Gain (dBi)

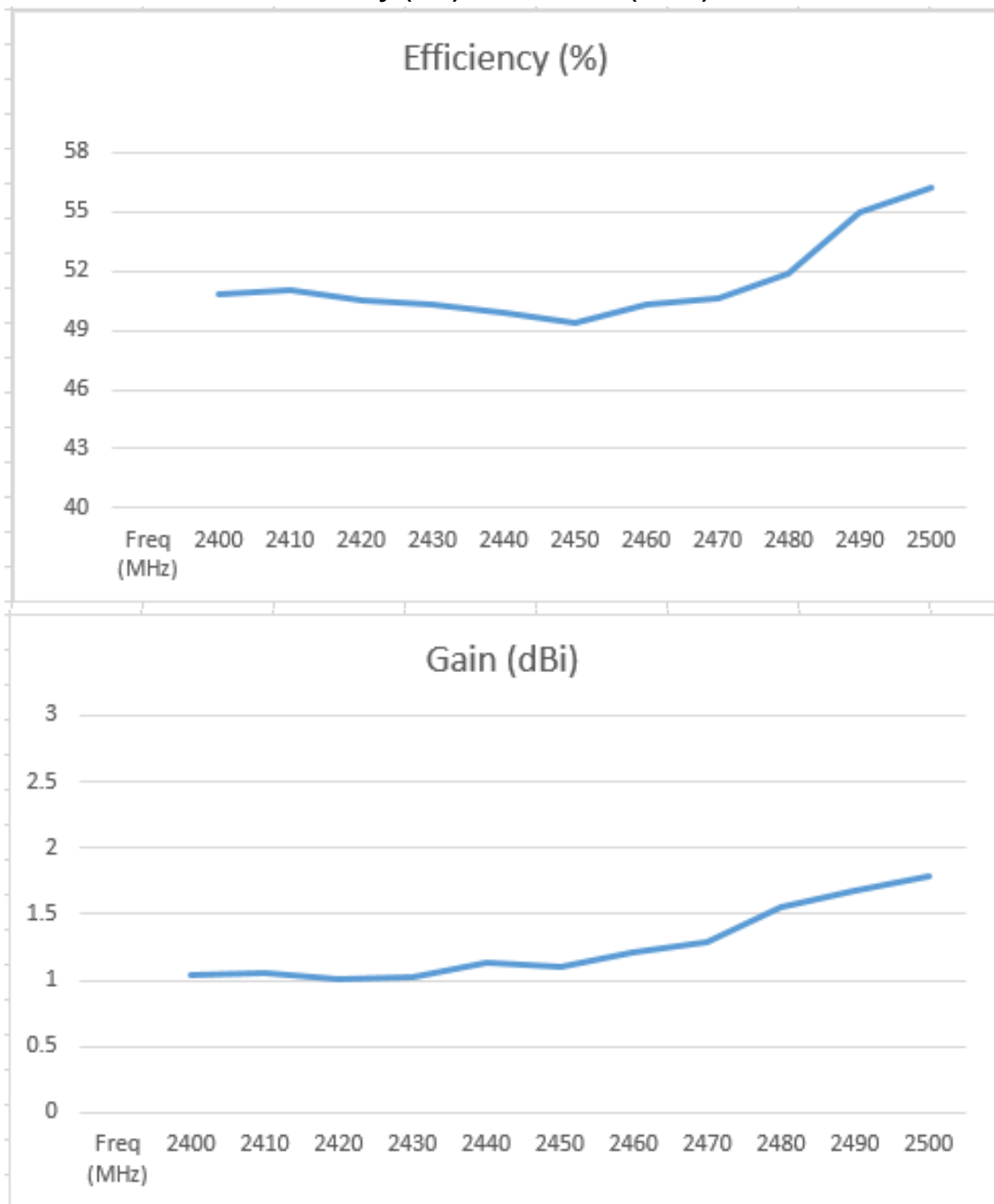

Issue: 1725

In the effort to improve our products, we reserve the right to make changes judged to be necessary.

CONFIDENTIAL AND PROPRIETARY INFORMATION

This document contains confidential and proprietary information of Pulse Electronics, Inc. (Pulse) and is protected by copyright, trade secret and other state and federal laws. Its receipt or possession does not convey any rights to reproduce, disclose its contents, or to manufacture, use or sell anything it may describe. Reproduction, disclosure or use without specific written authorization of Pulse is strictly forbidden.

Description: FPC 2.4G antenna

Series: Internal Antenna

PART NUMBER: W3921XXXXX

CHARTS

Typical free space radiation pattern
WIFI 2.4GHz

(* All RF parameters measured on 2mm thick PC plate

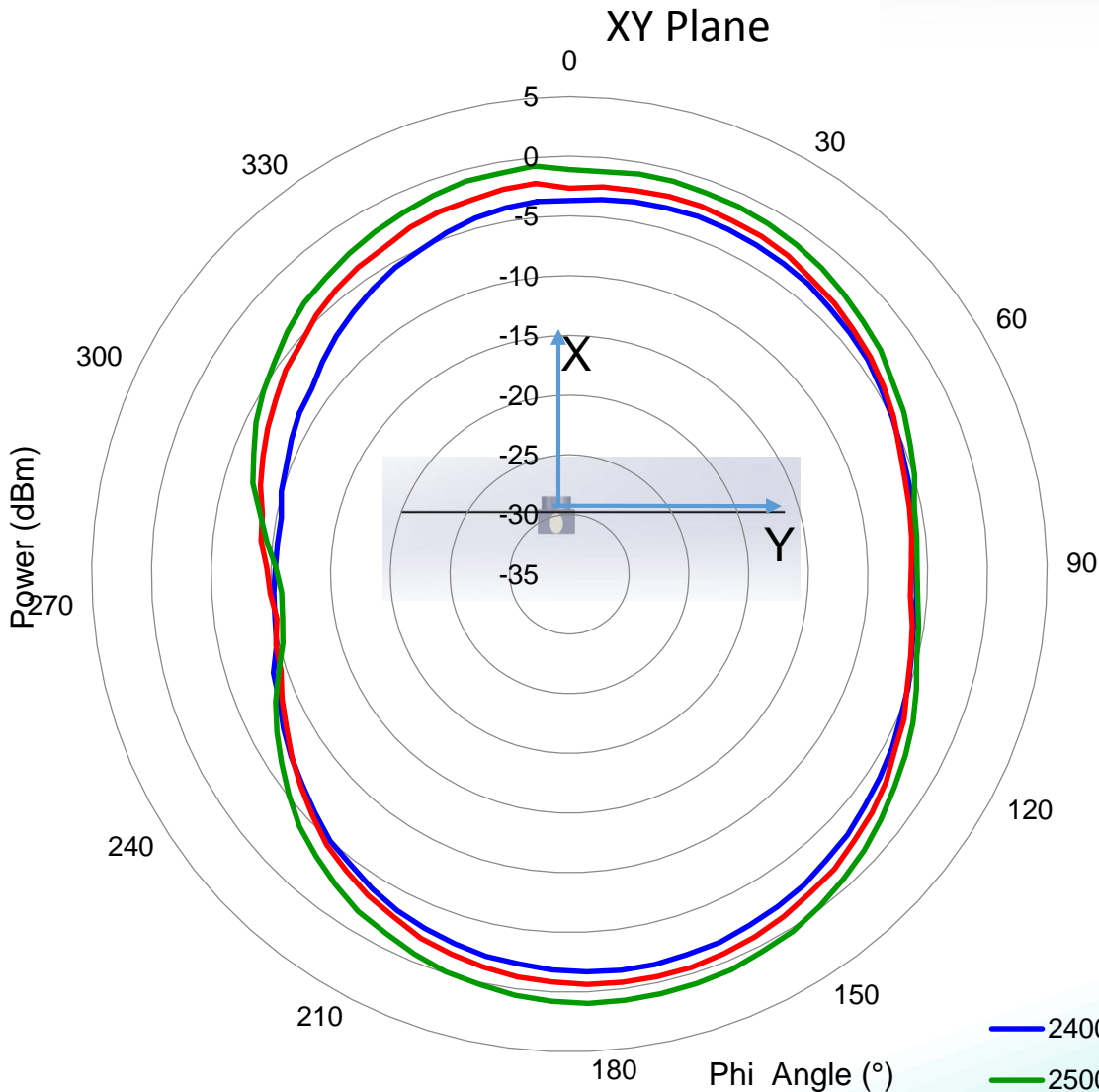
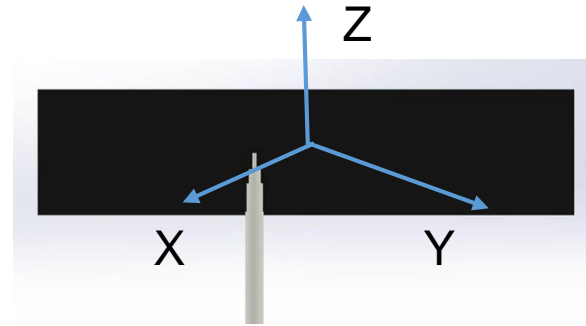

2400MHz
Avg (dBi) = -5.13
Peak (dBi) = -1.55
Avg -3 (deg) = 175

2450MHz
Avg (dBi) = -4.30
Peak (dBi) = -0.51
Avg -3 (deg) = 215

2500MHz
Avg (dBi) = -3.27
Peak (dBi) = 0.98
Avg -3 (deg) = 155

— 2400MHz — 2450MHz
— 2500MHz

Issue: 1725

In the effort to improve our products, we reserve the right to make changes judged to be necessary.

CONFIDENTIAL AND PROPRIETARY INFORMATION

This document contains confidential and proprietary information of Pulse Electronics, Inc. (Pulse) and is protected by copyright, trade secret and other state and federal laws. Its receipt or possession does not convey any rights to reproduce, disclose its contents, or to manufacture, use or sell anything it may describe. Reproduction, disclosure or use without specific written authorization of Pulse is strictly forbidden.



Description: FPC 2.4G antenna

Series: Internal Antenna

PART NUMBER: W3921XXXXX

CHARTS

Typical free space radiation pattern
WIFI 2.4GHz

(* All RF parameters measured on
2mm thick PC plate

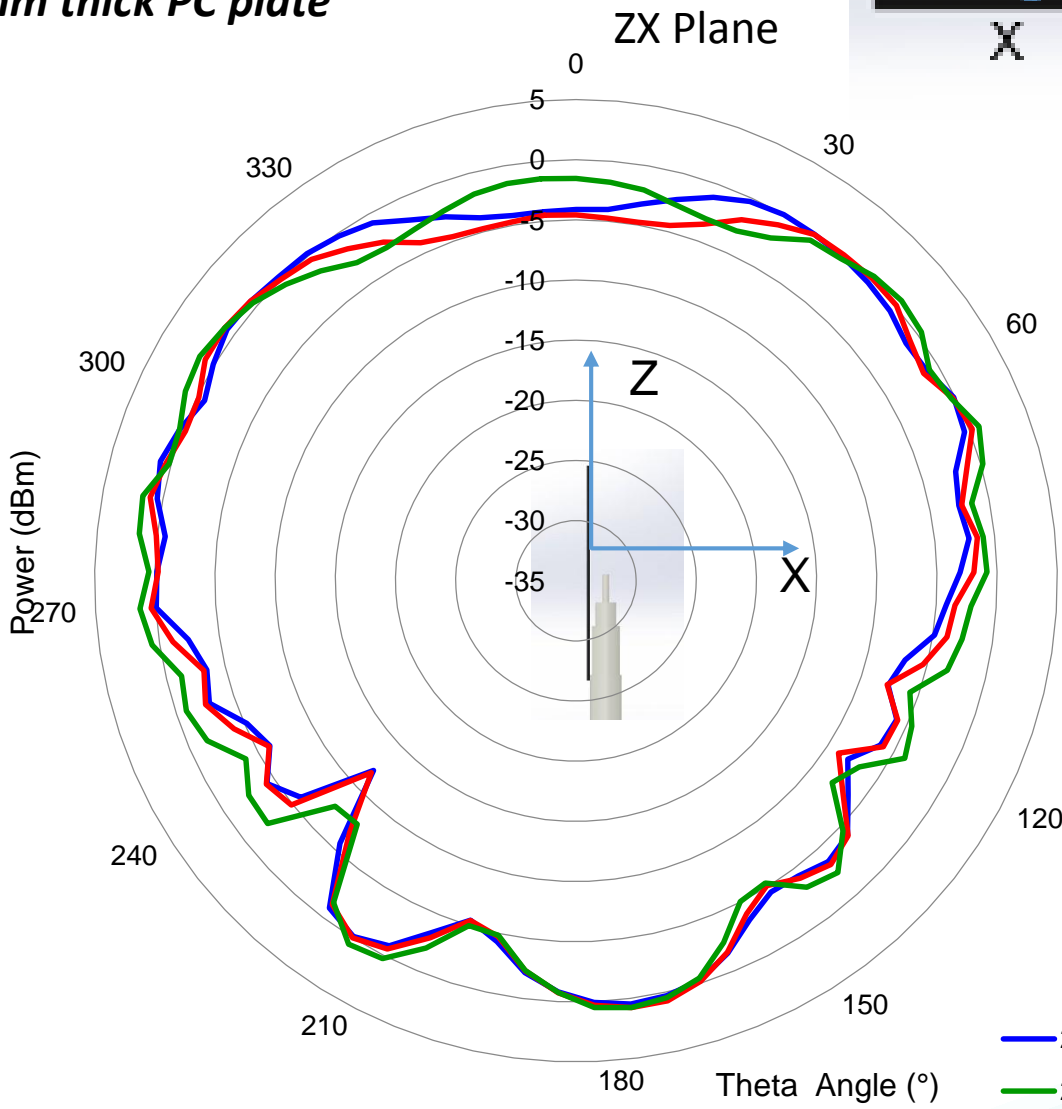
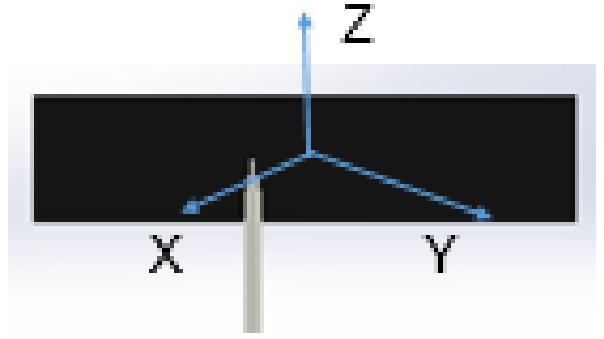

2400MHz	Avg (dBi) = -2.49
	Peak (dBi) = 0.92
	Avg -3 (deg) = 85
2450MHz	Avg (dBi) = -2.57
	Peak (dBi) = 1.05
	Avg -3 (deg) = 85
2500MHz	Avg (dBi) = -1.77
	Peak (dBi) = 1.68
	Avg -3 (deg) = 77.5

— 2400MHz — 2450MHz
— 2500MHz

Issue: 1725

In the effort to improve our products, we reserve the right to make changes judged to be necessary.
CONFIDENTIAL AND PROPRIETARY INFORMATION

This document contains confidential and proprietary information of Pulse Electronics, Inc. (Pulse) and is protected by copyright, trade secret and other state and federal laws. Its receipt or possession does not convey any rights to reproduce, disclose its contents, or to manufacture, use or sell anything it may describe. Reproduction, disclosure or use without specific written authorization of Pulse is strictly forbidden.



Description: FPC 2.4G antenna

Series: Internal Antenna

PART NUMBER: W3921XXXXX

CHARTS

Typical free space radiation pattern
WIFI 2.4GHz

(* All RF parameters measured on
2mm thick PC plate

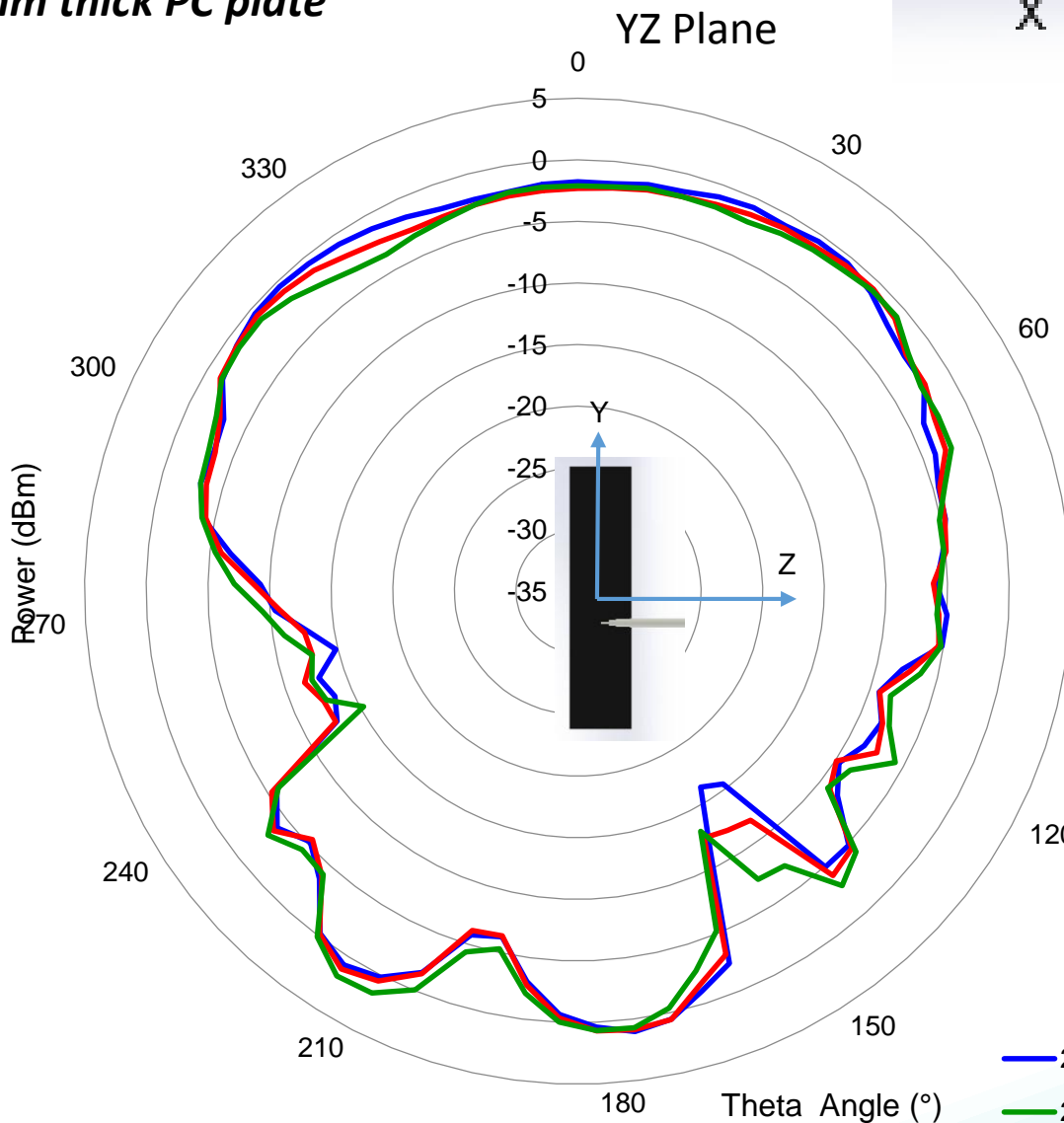
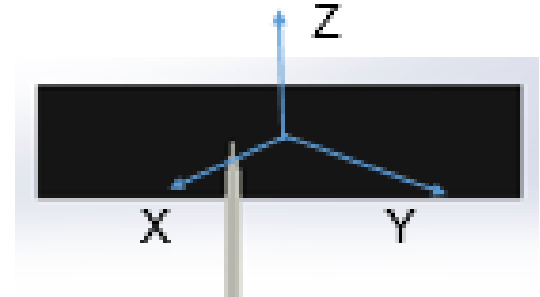

2400MHz	Avg (dBi) = -4.38
	Peak (dBi) = 1.02
	Avg -3 (deg) = 70
2450MHz	Avg (dBi) = -4.30
	Peak (dBi) = 1.17
	Avg -3 (deg) = 50
2500MHz	Avg (dBi) = -4.08
	Peak (dBi) = 1.83
	Avg -3 (deg) = 27.5

— 2400MHz — 2450MHz
— 2500MHz

Issue: 1725

In the effort to improve our products, we reserve the right to make changes judged to be necessary.

CONFIDENTIAL AND PROPRIETARY INFORMATION

This document contains confidential and proprietary information of Pulse Electronics, Inc. (Pulse) and is protected by copyright, trade secret and other state and federal laws. Its receipt or possession does not convey any rights to reproduce, disclose its contents, or to manufacture, use or sell anything it may describe. Reproduction, disclosure or use without specific written authorization of Pulse is strictly forbidden.



Description: FPC 2.4G antenna

Series: Internal Antenna

PART NUMBER: W3921XXXXX

PACKAGING

10PCS/PE bag

10 PE bag/foam bag

50 foam bag/ carton box

Total 5000PCS/Carton box



Issue: 1725

In the effort to improve our products, we reserve the right to make changes judged to be necessary.

CONFIDENTIAL AND PROPRIETARY INFORMATION

This document contains confidential and proprietary information of Pulse Electronics, Inc. (Pulse) and is protected by copyright, trade secret and other state and federal laws. Its receipt or possession does not convey any rights to reproduce, disclose its contents, or to manufacture, use or sell anything it may describe. Reproduction, disclosure or use without specific written authorization of Pulse is strictly forbidden.