



## MAX9880A Evaluation Kit

### General Description

The MAX9880A evaluation kit (EV kit) is a fully assembled and tested surface-mount PCB that evaluates the MAX9880A IC, which is a low-power, high-performance, stereo audio codec with audio processing. To facilitate evaluation, the EV kit includes input and output RCA connections, capless and single-ended headphone connectors (J3, J4), and two on-board digital microphones (U15, U16).

Integrated into the EV kit design is a digital audio transceiver (U11) and a USB stereo audio DAC (U12). The digital audio transceiver provides audio input and output through the on-board TOSLINK connectors (J5, J6) and the USB stereo audio DAC provides audio input through the mini-USB connector (J10).

The device's I<sup>2</sup>C/2-wire and SPI™ control bus are interfaced to the on-board MAXQ2000 microcontroller, allowing for evaluation with the EV kit software.

### Features

- ◆ **USB Powered**
- ◆ **Configurable I<sup>2</sup>C/2-Wire or SPI Interface**
- ◆ **USB, TOSLINK, and RCA Audio Input Connections**
- ◆ **3.5mm, TOSLINK, and RCA Audio Output Connections**
- ◆ **Windows® 2000-, Windows XP®, and Windows Vista® (32-Bit)-Compatible Software**
- ◆ **Surface-Mount Components**
- ◆ **Proven PCB Layout**
- ◆ **Fully Assembled and Tested**

### Ordering Information

PART	TYPE
MAX9880AEVKIT#	EV Kit

#Denotes RoHS compliant.

### Component List

DESIGNATION	QTY	DESCRIPTION
CLK, DATA	0	Not installed, miniature test points
C1–C9, C12–C17, C23–C26, C33, C43, C50, C53, C54, C67, C68, C71, C77–C86, C92, C93	39	1µF ±10%, 10V X5R ceramic capacitors (0402) Murata GRM155R61A105K
C10	1	2.2µF ±20%, 6.3V X5R ceramic capacitor (0402) Murata GRM155R60J225M Taiyo Yuden JMK105BJ225MV-F
C11, C18	2	220µF ±20%, 4V tantalum capacitors (S case) Nichicon F950G227MSAAM1Q2
C19, C20, C31, C32, C57	5	0.01µF ±10%, 25V X7R ceramic capacitors (0402) Murata GRM155R71E103K

DESIGNATION	QTY	DESCRIPTION
C21, C22, C27, C29, C35, C40, C42, C44–C47, C51, C55, C56, C69, C75, C76	17	0.1µF ±10%, 6.3V X5R ceramic capacitors (0402) Murata GRM155R60J104K
C28	1	4700pF ±10%, 25V X7R ceramic capacitor (0603) Murata GRM188R71E473K TDK C1608X7R1E473K
C30	1	0.47µF ±10%, 6.3V X5R ceramic capacitor (0603) Murata GRM188R60J474K TDK C1608X5R0J474K
C34, C36, C37, C41, C73, C74	6	8pF ±0.5pF, 50V C0G ceramic capacitors (0402) Murata GRM1555C1H8R0D Taiyo Yuden UMK105CH080DV
C38, C58–C65, C87–C90	0	Not installed, ceramic capacitors (0402)

SPI is a trademark of Motorola, Inc.  
Windows, Windows XP, and Windows Vista are registered trademarks of Microsoft Corp.



# MAX9880A Evaluation Kit

Evaluates: MAX9880A

## Component List (continued)

DESIGNATION	QTY	DESCRIPTION
C39	1	33000pF ±10%, 16V X7R ceramic capacitor (0603) Murata GRM188R71C333K
C48, C49	2	18pF ±5%, 50V C0G ceramic capacitors (0603) Murata GRM1885C1H180J TDK C1608C0G1H180J
C52, C70, C91	3	10µF ±10%, 6.3V X5R ceramic capacitors (0805) Murata GRM219R60J106K
C66, C72	2	47µF ±20%, 6.3V tantalum capacitors (0805) AVX TLJR476M006R3200
D1	1	Yellow LED (0603)
D2	1	Red LED (0603)
FB1, FB2	2	0Ω resistors (0603)
J1, J9	2	Phono jacks (side-entry PCB mount), white
J2, J8	2	Phono jacks (side-entry PCB mount), red
J3	1	4-conductor, 3.5mm stereo headphone jack
J4	1	3.5mm stereo headphone jack
J5	1	Fiber optic transmitting module Toshiba TOTX147AL
J6	1	Fiber optic receiving module Toshiba TORX147L
J7, J10	2	Mini-USB type-B connectors
JU1–JU11, JU14–JU18, JU21, JU22, JU24, JU25, JU26, JU28, JU29	23	2-pin headers, 0.1in centers
JU12	1	5-pin header, 0.1in centers
JU13, JU19, JU27	3	3 x 4-pin headers, 0.1in centers
JU20	1	3 x 2-pin header, 0.1in centers
JU23, JU30	0	Not installed, 3-pin headers, 0.1in centers

DESIGNATION	QTY	DESCRIPTION
L1	1	47µH inductor Murata LQH43MN470J03L
R1–R4, R27	5	2.2kΩ ±1% resistors (0402)
R5, R6, R8, R28, R39	5	10kΩ ±5% resistors (0402)
R7, R15, R16, R29, R45–R48	0	Not installed, resistors (0402)
R9–R14, R30– R33, R41–R44	14	0Ω resistors (0402)
R17	1	402Ω ±1% resistor (0603)
R18	1	47kΩ ±5% resistor (0603)
R19, R20	2	220Ω ±5% resistors (0603)
R21, R22, R23	3	1.5kΩ ±5% resistors (0603)
R24, R25	2	27Ω ±5% resistors (0603)
R26	1	470Ω ±5% resistor (0603)
R34, R37	2	1.5kΩ ±5% resistors (0402)
R35, R36	2	22Ω ±5% resistors (0402)
R38	1	1MΩ ±5% resistor (0402)
TP1–TP5	5	Miniature test points
U1	1	Audio codec (48 WLP) Maxim MAX9880AEWM+
U2, U3	0	Not installed, SPDM left-input Class D amplifiers (9 WLP)
U4	1	Bidirectional 4-channel level translator (12 UCSP™) Maxim MAX13042EEBC+
U5	1	Microcontroller (56 TQFN-EP) Maxim MAXQ2000-RBX+
U6, U7	2	3.3V low-noise linear regulators (5 SC70) Maxim MAX8511EXK33+ (Top Mark: AEI)
U8, U9	2	1.8V low-noise linear regulators (5 SC70) Maxim MAX8510EXK18+ (Top Mark: AEA)

UCSP is a trademark of Maxim Integrated Products, Inc.

# MAX9880A Evaluation Kit

## Component List (continued)

DESIGNATION	QTY	DESCRIPTION
U10	1	2.5V low-noise linear regulator (5 SC70) Maxim MAX8511EXK25+ (Top Mark: ADV)
U11	1	Digital audio transceiver (28 SO) Cirrus CS8427-CSZ
U12	1	USB audio codec (32 QFP) Texas Instruments PCM2707PJT
U13	1	USB-to-UART converter (32 QFN) FTDI FT232BQ
U14	1	EEPROM (8 SO) Atmel AT93C46EN-SH-B
U15, U16	2	1.8V digital microphones (6 LGA)
U17	1	Logic-level translator (10-pin $\mu$ MAX <sup>®</sup> ) Maxim MAX1840EUB+

DESIGNATION	QTY	DESCRIPTION
Y1	1	12.288MHz crystal (3.2mm x 2.5mm) Kyocera CX3225SB12288D0FLJZ1
Y2	1	13MHz crystal oscillator (2.5mm x 2mm) ECS Inc. ECS-2033-130-BN
Y3	1	16MHz crystal oscillator (3.2mm x 2.5mm)
Y4	1	12MHz crystal oscillator (3.2mm x 2.5mm)
Y5	1	6MHz crystal
—	38	Shunts
—	1	PCB: MAX9880A EVALUATION KIT

**Evaluates: MAX9880A**

## Component Suppliers

SUPPLIER	PHONE	WEBSITE
AVX Corporation	843-946-0238	www.avx.com
Murata Electronics North America, Inc.	770-436-1300	www.murata-northamerica.com
Nichicon USA	858-824-1515	www.nichicon-us.com
Taiyo Yuden	800-348-2496	www.t-yuden.com
TDK Corp.	847-803-6100	www.component.tdk.com
Toshiba America Electronic Components, Inc.	949-623-2900	www.toshiba.com/taec

**Note:** Indicate that you are using the MAX9880A when contacting these component suppliers.

$\mu$ MAX is a registered trademark of Maxim Integrated Products, Inc.

# MAX9880A Evaluation Kit

## Quick Start

### Required Equipment

- MAX9880A EV kit (USB cable included)
- Audio source with mini-USB connection
- Headphones and/or a speaker
- Windows 2000, Windows XP, or Windows Vista PC with a spare USB port

**Note:** In the following sections, software-related items are identified by bolding. Text in **bold** refers to items directly from the EV kit software. Text in **bold and underlined** refers to items from the Windows operating system.

### Procedure

The EV kit is fully assembled and tested. Follow the steps below to verify board operation:

- 1) Visit [www.maxim-ic.com/tools/evkit/](http://www.maxim-ic.com/tools/evkit/) to download the latest version of the EV kit software, 9880ARxx.ZIP. Save the EV kit software to a temporary folder and uncompress the ZIP file.
- 2) Install the EV kit software on your computer by running the INSTALL.EXE program inside the temporary folder. The program files are copied and icons are created in the Windows **Start | Programs** menu.
- 3) Verify that the shunts on jumpers JU13, JU19, JU20, and JU27 are configured as shown in Figure 1 (the line indicates a shunt installation).
- 4) Verify that the remaining jumpers are configured as listed in Table 1.
- 5) Connect the USB cable from the PC to the EV kit board's J7 mini-USB connector. A **Building Driver Database** window pops up in addition to a **New Hardware Found** message if this is the first time the EV kit board is connected to the PC. If a window is not seen that is similar to the one described above after 30s, remove the USB cable from the EV kit and

reconnect it. Administrator privileges are required to install the USB device driver on Windows 2000, Windows XP, and Windows Vista.

- 6) Follow the directions of the **Add New Hardware Wizard** to install the USB device driver. Choose the **Search for the best driver for your device** option. Specify the location of the device driver to be **C:\Program Files\MAX9880A** (default installation directory) using the **Browse** button. Refer to the USB\_Driver\_Help.PDF document included with the software for additional information.
- 7) Connect the headphones to the capless 3.5mm headphone jack (J4) and/or speakers to the OTR (J8) and OUTL (J9) RCA output connectors.
- 8) Connect the audio source to the mini-USB input connector (J10).
- 9) Enable the audio source.
- 10) Start the EV kit software by opening its icon in the **Start | Programs** menu.
- 11) Perform a software quick start by selecting the **Quick Start F3** menu item from the **Tools** menu bar (or by pressing F3).
- 12) Verify that the input audio can be heard through the connected headphones and/or speakers.
- 13) The EV kit is now ready for further evaluation.

**Table 1. Remaining Jumper Positions (JU1–JU12, JU14–JU18, JU21, JU22, JU24, JU25, JU26, JU28, JU29)**

JUMPER	SHUNT POSITION
JU1–JU11, JU18, JU24, JU25, JU26, JU28, JU29	Not installed
JU12	1-4
JU14–JU17, JU21, JU22	Installed

# MAX9880A Evaluation Kit

Evaluates: **MAX9880A**

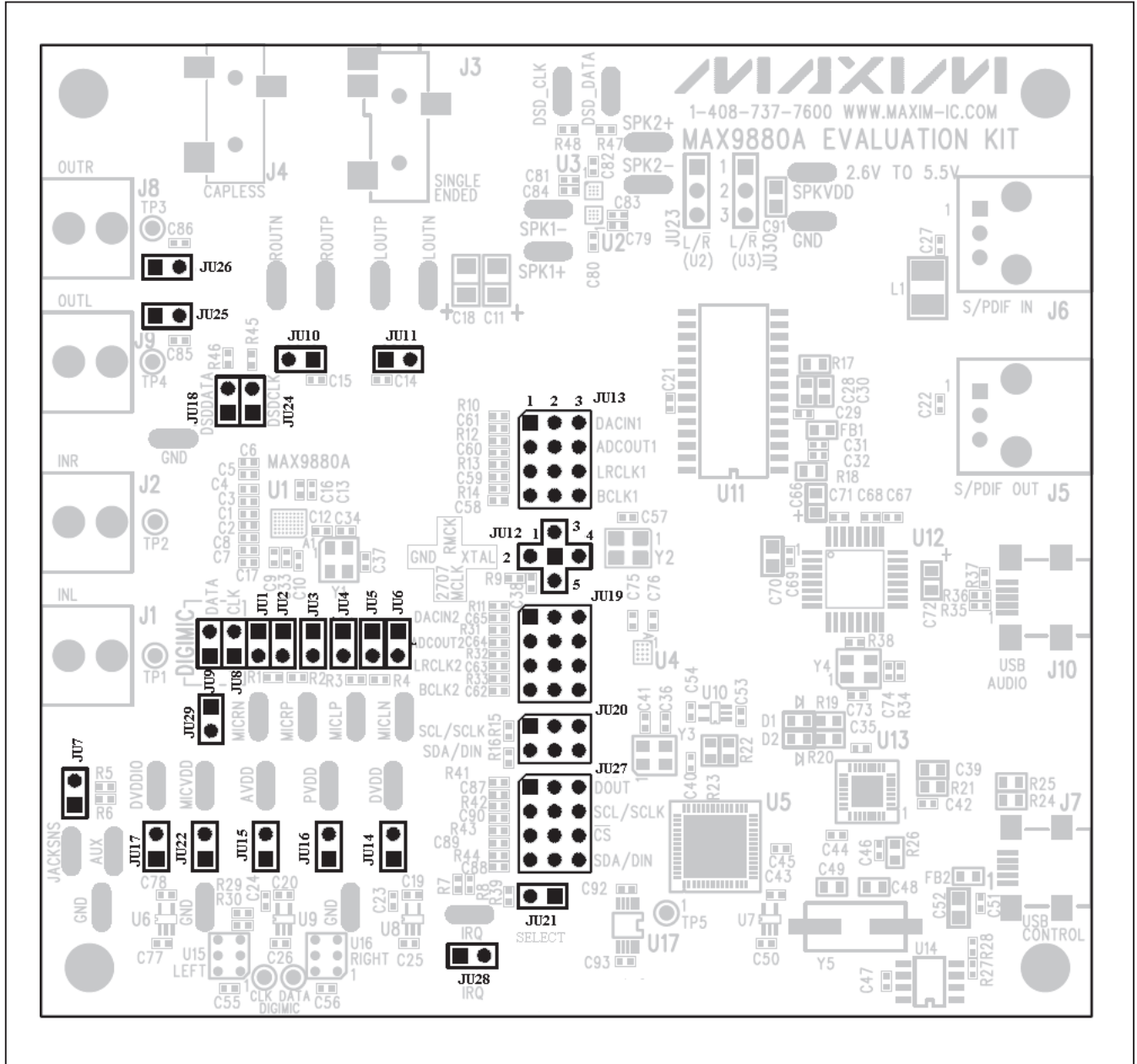

Figure 1. Default Shunt Positions (JU13, JU19, JU20, and JU27)

# MAX9880A Evaluation Kit

## \_\_Detailed Description of Software

The MAX9880A EV kit software is divided into three tabs: **Analog Audio**, **Digital Audio**, and **Control Registers**. The analog and digital tabs are image-based tabs, providing a visualization of the MAX9880A's (U1) configuration and an interpretation of the register organization. The control tab provides a map of the device registers, as well as configuration control of each register bit.

The software also includes a **Status** group box (see the *Status Register* section), five command buttons, a menu bar, and a status bar. The status bar is used to report EV kit connectivity, the interface mode, the device's address

(I<sup>2</sup>C mode), and the device's revision ID. The functionality of the command buttons is provided in Table 2 and the menu bar items are discussed in the *Menu Bar* section.

The controls for the device registers are discussed in subsequent sections, which have been organized in the same manner as the register descriptions in the MAX9880A IC data sheet. As such, when evaluating the EV kit hardware and software, both the IC data sheet and the EV kit data sheet should be referenced.

### Menu Bar

The software's menu bar provides five drop-down menus: **File**, **View**, **Options**, **Tools**, and **Help**. Their associated menu items are listed and detailed in Table 3.

**Table 2. Command Buttons**

BUTTON	FUNCTIONALITY
<b>Read All</b>	Reads all device registers and updates all three tabs to reflect the state of the device registers.
<b>Write All</b>	Writes all the hex values (0x??) shown on the <b>Control Registers</b> tab to the associated register on the U1 device.
<b>Reset</b>	Resets the device to its power-on-reset (POR) state.
<b>Connect</b>	Attempts to establish a connection to the EV kit. First establishing a connection with the EV kit's on-board microcontroller (MAXQ2000) and then with the device.
<b>MAX9880A Power</b>	Toggles the device $\overline{\text{SHDN}}$ bit. When enabled, the button's image turns blue.

**Table 3. Menu Bar Items**

MENU ITEMS	DESCRIPTION
<b>File</b>	
Load Settings CTRL+O	Loads/saves a .ax27 configuration file (see the <i>Save/Load Settings</i> section).
Save Settings CTRL+S	
Exit	Closes the software.
<b>View</b>	
Show S/PDIF Transceiver Registers	Enables the CS8427 register tab, providing access to the digital audio transceiver's (U11) registers (refer to the Cirrus Logic CS8427 data sheet for details).
<b>Options</b>	
Auto Connect	Enables continuous device detection.
Auto Read Status	Enables polling of the Status register (0x00).
Interrupt Enables	Set/clear the device's interrupt enables.
I <sup>2</sup> C Clock Speed	Provides I <sup>2</sup> C clock options: 100kHz or 400kHz.
<b>Tools</b>	
Interface (Advanced User) F1	Opens the <b>Advanced User Interface</b> window (see the <i>Advanced User Interface</i> section).
Quick Start F3	Automatically establishes a connection with the EV kit and the U1 device (I <sup>2</sup> C mode only), then enables the U1 device and configures it for USB audio input (see the <i>Quick Start</i> section for hardware setup).
Quick Connect F4	Establishes a connection with the EV kit and the U1 device (I <sup>2</sup> C mode only), then enables the device.
<b>Help</b>	
Help F2	Provides instructions on where to find the latest EV kit data sheet.
About	Provides software information.



# MAX9880A Evaluation Kit

Evaluates: MAX9880A

## Audio Tabs

The **Analog Audio** and **Digital Audio** tabs utilize images to illustrate the capabilities of the U1 device, display its current configuration, and provide a visualization of the signal paths from input to output. Figure 2 shows

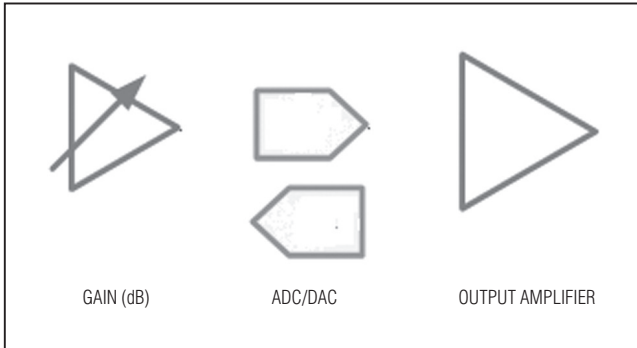

Figure 2. GUI Blocks

some of the different GUI images, aside from the various rectangular blocks, that are used to access device registers. In most cases, selecting an image brings up a secondary window that provides controls for configuring the device. When making register changes, the block's color changes from gray to blue when that signal path has been properly configured and activated.

**Note:** Placing the cursor over an image brings up a hint box, displaying a list of registers associated with that image.

Figures 3 and 4 show the state of the software's **Analog Audio** and **Digital Audio** tabs after the procedure in the **Quick Start** section has been performed. The device is configured to take a USB audio signal, connected to J10, and output it on the capless headphone jack (J4) and line output connectors (J8, J9).

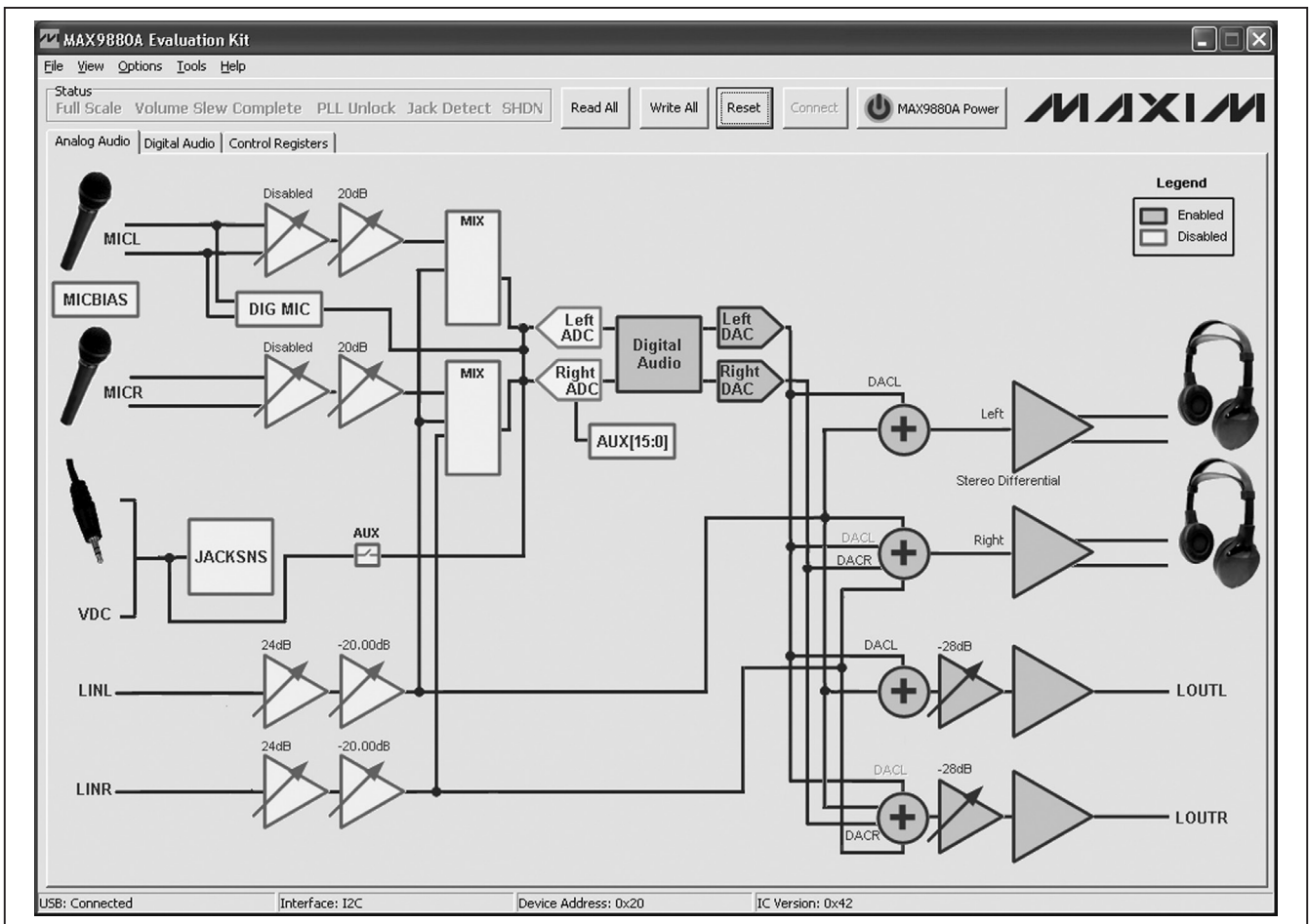

Figure 3. Analog Audio Tab

# MAX9880A Evaluation Kit

Evaluates: MAX9880A

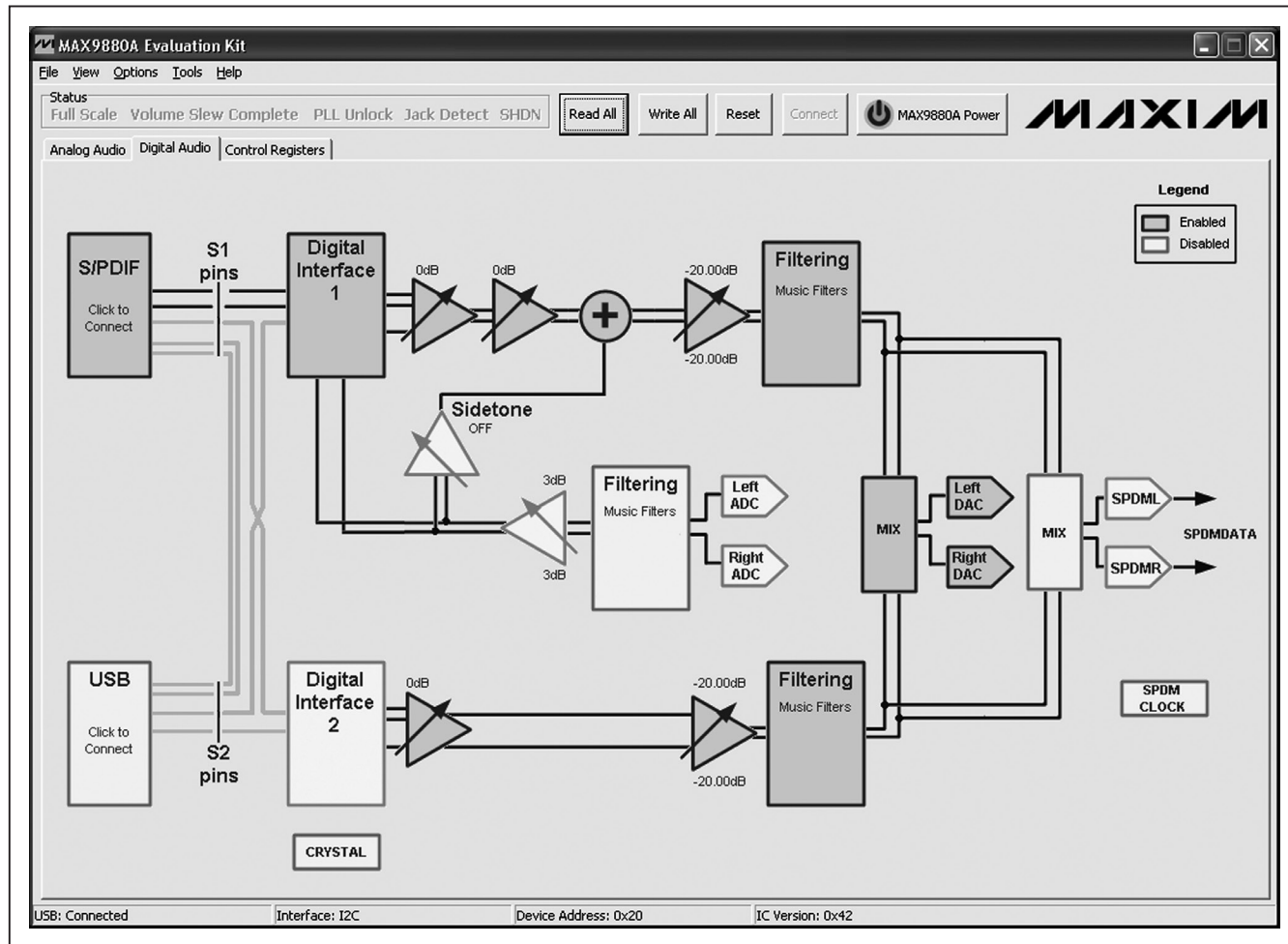

Figure 4. Digital Audio Tab



# MAX9880A Evaluation Kit

Evaluates: MAX9880A

## Control Registers Tab

The **Control Registers** tab (Figure 5) contains a register map of the U1 device. The tab is organized from left to right with the register names, bit names, and edit boxes. The bit names are used to display the current state of each bit (bold text = 1). In addition, a register's bits can be individually toggled by single-clicking on the bit's name.

The edit boxes are used to display a register's current state and are updated after a read all, bit click, or con-

figuration change has been made on the **Analog Audio** and **Digital Audio** tabs. The edit boxes can also be used to configure the device registers. This is accomplished by entering the desired 8-bit hex value (0x??) into the edit box and then pressing the Enter key.

**Note:** the register addresses provided on the **Control Registers** tab are for I<sup>2</sup>C. When operating in SPI mode, the register addresses are obtained by adding 0x200 to the I<sup>2</sup>C address. The 0xFF register is not accessible in SPI mode.

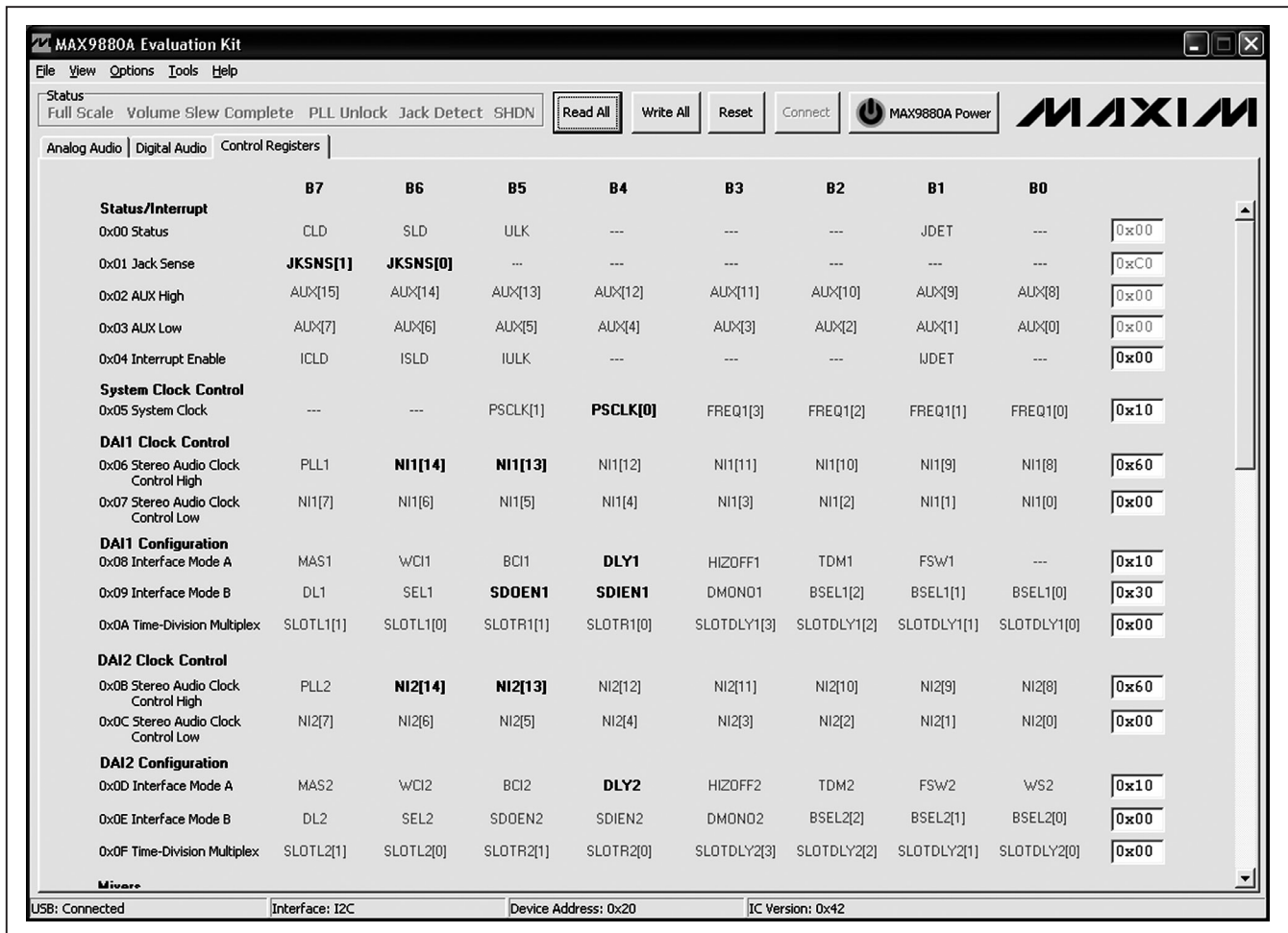

Figure 5. Control Registers Tab

# MAX9880A Evaluation Kit

**Table 4. S/PDIF Transceiver Window Controls**

CONTROL	DESCRIPTION
Enable SPDIF checkbox	Enables autoconfiguration of the CS8427 digital audio transceiver (U11).
Autoconfigure CODEC checkbox	When checked, it enables auto configuration of the U1 device. When not checked, the U1 device must be manually configured.
Signal Path radio buttons	Provides three auto-configure options ( <b>Playback only</b> , <b>Record only</b> , and <b>Playback and Record</b> ) used to auto configure the U1 and U11 devices (see below for signal path details).
LRCLK Frequency drop-down list	Provides LRCLK frequency options. Refer to the <i>Clock Control</i> section in the MAX9880A IC data sheet.
Cancel button	Closes the window without making configuration changes.
Configure button	Auto configures the U11 device (if <b>Enable SPDIF</b> is checked) or auto configures the U1 device (if <b>Autoconfigure CODEC</b> is checked); autoconfigurations are based on the <b>Signal Path</b> and <b>LRCLK Frequency</b> selections.

**Table 5. USB Audio (Enable Window)**

BUTTON	DESCRIPTION
Yes	Enables the USB audio playback and auto configures the U1 device.
No	Enables the USB audio playback only (the U1 device must be manually configured).
Cancel	Closes the window (the USB audio is not enabled and the U1 device is not configured).

**Table 6. USB Audio (Disable Window)**

BUTTON	DESCRIPTION*
OK	Disables the USB audio playback.
Cancel	Closes the window (the USB audio playback is not disabled).

\*This window only disables the USB audio playback. The U1 device configuration is not changed.

### S/PDIF Audio

The **S/PDIF** block on the **Digital Audio** tab opens the **S/PDIF Transceiver** window (Figure 6), which provides controls for evaluating the U1 device with the on-board digital audio transceiver (U11). The digital audio transceiver is hardwired to the U1 device's S1 interface through header JU13. See the *Digital Audio Interfaces (S1, S2)* section for hardware details. The available controls and their descriptions are listed in Table 4.

For the devices to automatically be configured, a signal path and LRCLK frequency must be selected and the **Enable SPDIF** and **Autoconfigure CODEC** checkboxes must be checked. In addition, the master clock input (MCLK) should be configured as instructed by the window's displayed text. See the *Master Clock (MCLK)* section for MCLK configuration options.

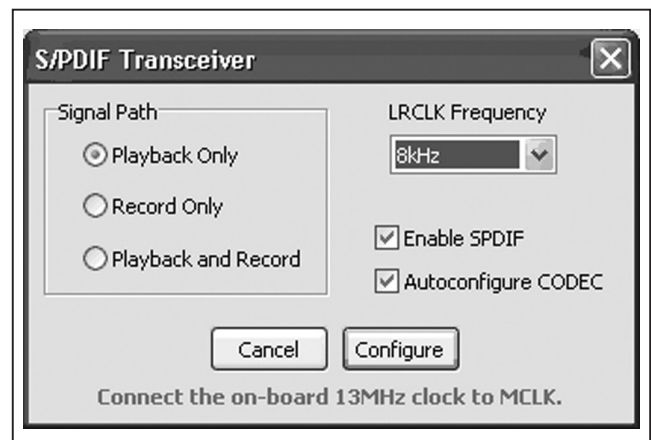

Figure 6. S/PDIF Transceiver Window

### USB Audio

The **USB** block on the **Digital Audio** tab opens the **USB Audio** window that either enables or disables audio playback through the on-board USB stereo audio DAC (U12), depending on the current enabled/disabled state. This allows USB audio to be played through the U1 device. The USB stereo audio DAC is hardwired to the U1 device's S2 interface through header JU19. See the *Digital Audio Interfaces (S1, S2)* section for hardware details. The enable and disable window (Figures 7a and 7b) options are listed in Tables 5 and 6.

# MAX9880A Evaluation Kit

## Status Register

The **Status** group box provides labels that report the state of the Status register bits (CLD, SLD, ULK, JDET) and the  $\overline{\text{SHDN}}$  bit (see Table 7). The other status registers (Jack Status, AUX) are reported on their individual windows. Jack Status can be monitored by selecting the **JACKSNS** block, and the AUX registers are reported on the **Auxiliary Configuration** window, which is accessed by selecting the **AUX[15:0]** block. See the *Jack Detection* and *ADC Input Register* sections.

## Interrupt Enables

Hardware interrupts are enabled/disabled by setting/clearing the interrupt item listed under the **Options 1 Interrupt Enables** menu item. In order for a status register flag to be reported on the device's open-drain  $\overline{\text{IRQ}}$  pin, the corresponding interrupt enable bit must be set. Otherwise, the flag is only reported as a software interrupt in the **Status** group box.

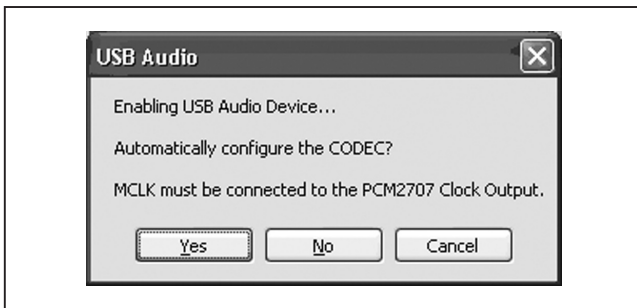

Figure 7a. USB Stereo Audio DAC (Enable Window)



Figure 7b. USB Stereo Audio DAC (Disable Window)

## Digital Audio Interface and Clock Registers

The system and digital audio clock registers and digital audio interface registers are all accessed by selecting the **Digital Interface 1** or **Digital Interface 2** blocks on the **Digital Audio** tab. The DAI1 clock control and configuration registers are controlled through the digital audio interface 1 windows and the DAI2 clock control and configuration registers are controlled through the digital audio interface 2 windows. Each of the digital audio interfaces has two windows, basic and advanced. The System Clock register (0x05) is accessed from both digital audio interface windows.

The first time selecting a **Digital Interface** block, on the **Digital Audio** tab, opens the digital audio interface's basic window. The interface's advanced window is initially accessed by pressing the **Advanced Mode** button on the digital audio interface basic windows. Similarly, the basic window can be accessed by pressing the **Basic Mode** button on the advanced window. Any subsequent clicking of the **Digital Interface** blocks opens either the basic or advanced interface window, whichever window was active last.

See the *Digital Audio Interface 1 - Basic* and *Digital Audio Interface 1 - Advanced* sections and refer to the *Clock Control* and *Digital Audio Interface* sections of the MAX9880A IC data sheet for a complete understanding on how to use and configure the digital audio interfaces.

Table 7. Status Bits

LABEL	BIT (REGISTER)
Full Scale	CLD (0x00)
Volume Slew Complete	SLD (0x00)
PLL Unlock	ULK (0x00)
Jack Detect	JDET (0x00)
SHDN (shutdown)	$\overline{\text{SHDN}}$ (0x27)

Table 8. DAI\_ Basic Window Controls

CONTROL	DESCRIPTION
<b>MCLK Frequency</b> edit box	Derives the PSCLK setting from the MCLK frequency.
<b>Master/Slave</b> drop-down list	Sets the master mode bit (MAS_).
<b>Audio Selection</b> drop-down list	Configures the connection between S1/S2 pins and DAI1/DAI2 signal paths (SEL_, SDOEN_, SDIEN_ bits).
<b>LRCLK Frequency</b> drop-down list	Configures clock control when the interface is set for normal or PLL mode.
<b>Configuration</b> drop-down list	Configures the delay mode, TDM mode, and TDM slot.
<b>Configure</b> button	Configures the U1 device and closes the window.
<b>Advanced Mode</b> button	Opens the digital audio interface's advanced window.
<b>Cancel</b> button	Closes the window without configuring the U1 device.

# MAX9880A Evaluation Kit

## Digital Audio Interface 1 - Basic

This window provides basic controls for configuring the digital audio interfaces. In this window, when making configuration changes, the **Configure** button must be pressed for the settings to be applied to the device. See Table 8 for a description of the controls on the interface's basic window shown in Figure 8.

## Digital Audio Interface 1 - Advanced

The advanced window (Figure 9) provides more direct configuration of each digital audio interface. The window is divided into several group boxes, each of which is described in Table 9. See Table 9 for a description of the controls on the interface's advanced window shown in Figure 9.

## Digital Mixers

The audio mixers for the left and right DACs are configured on the **DAC Mixer** window (Figure 10), which is opened by selecting the **DAC MIX** block on the **Digital Audio** tab. Selecting the DAI1 checkboxes enables the DAC gain, voice DAC level, volume control, and filtering blocks for the DAI1 signal path. Selecting the DAI2 checkboxes enables the stereo DAC level, volume control, and filtering blocks for the DAI2 signal path. See the *Digital Gain Registers*, *Line Input Registers*, and *Digital Filtering Registers* sections for block-specific details.

## Digital Filtering Registers

The devices' IIR (voice) and FIR (audio) digital filters are configured by selecting the appropriate **Filtering** block on the **Digital Audio** tab. Filtering for the DAI1 signal

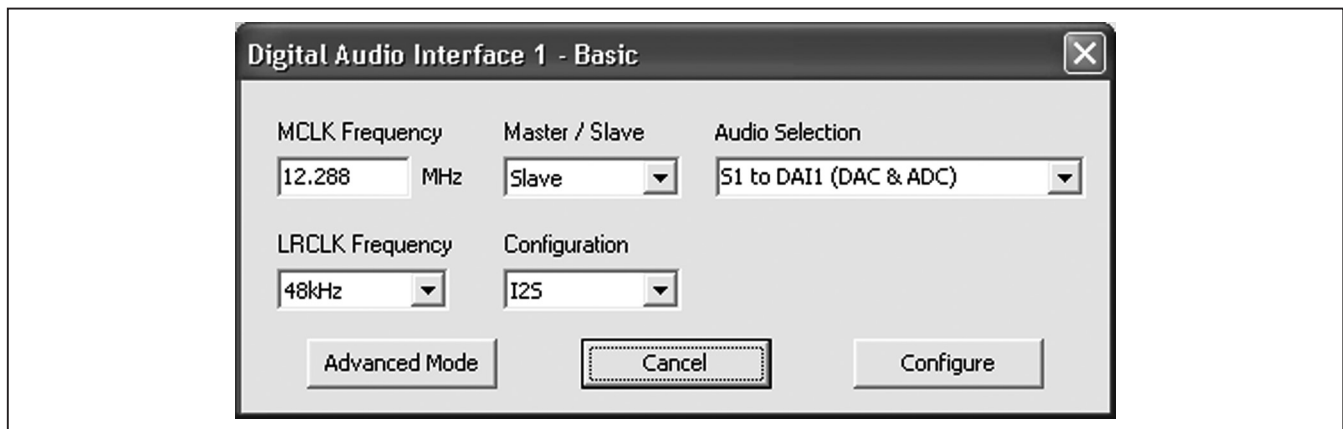

Figure 8. Digital Audio Interface 1 - Basic Window

Table 9. DAI\_ Advanced Window Controls

GROUP BOX	DESCRIPTION
<b>Audio Selection</b>	Configures SDOEN_, SDIEN_, and SEL_ of both digital audio interfaces.
<b>Data Loop</b>	Configures the DL_ bit of the audio interface. Also sets the SEL_ bit of the other audio interface if <b>SDINS1 to SDOUTS2</b> is selected.
<b>Configuration</b>	Configures MAS_, BSEL_, WCI_, BCI_, DLY_, and HIZOFF_ of the audio interface. Also configures DMONO for DAI1 (DAI1 window only) and WS and DHF for DAI2 (DAI2 window only).
<b>TDM Mode</b>	Configures TDM_, SLOTL_, SLOTR_, and FSW_.
<b>Data Delay</b>	Configures SLOTDLY_.
<b>Clock Control</b>	Configures PSCLK, FREQ1, NI_, and PLL_. The <b>Rapid Lock Mode</b> checkbox enables rapid lock mode when the device is configured for slave mode (MAS_ bit = 0) and the PLL_ bit = 1.

# MAX9880A Evaluation Kit

Evaluates: MAX9880A

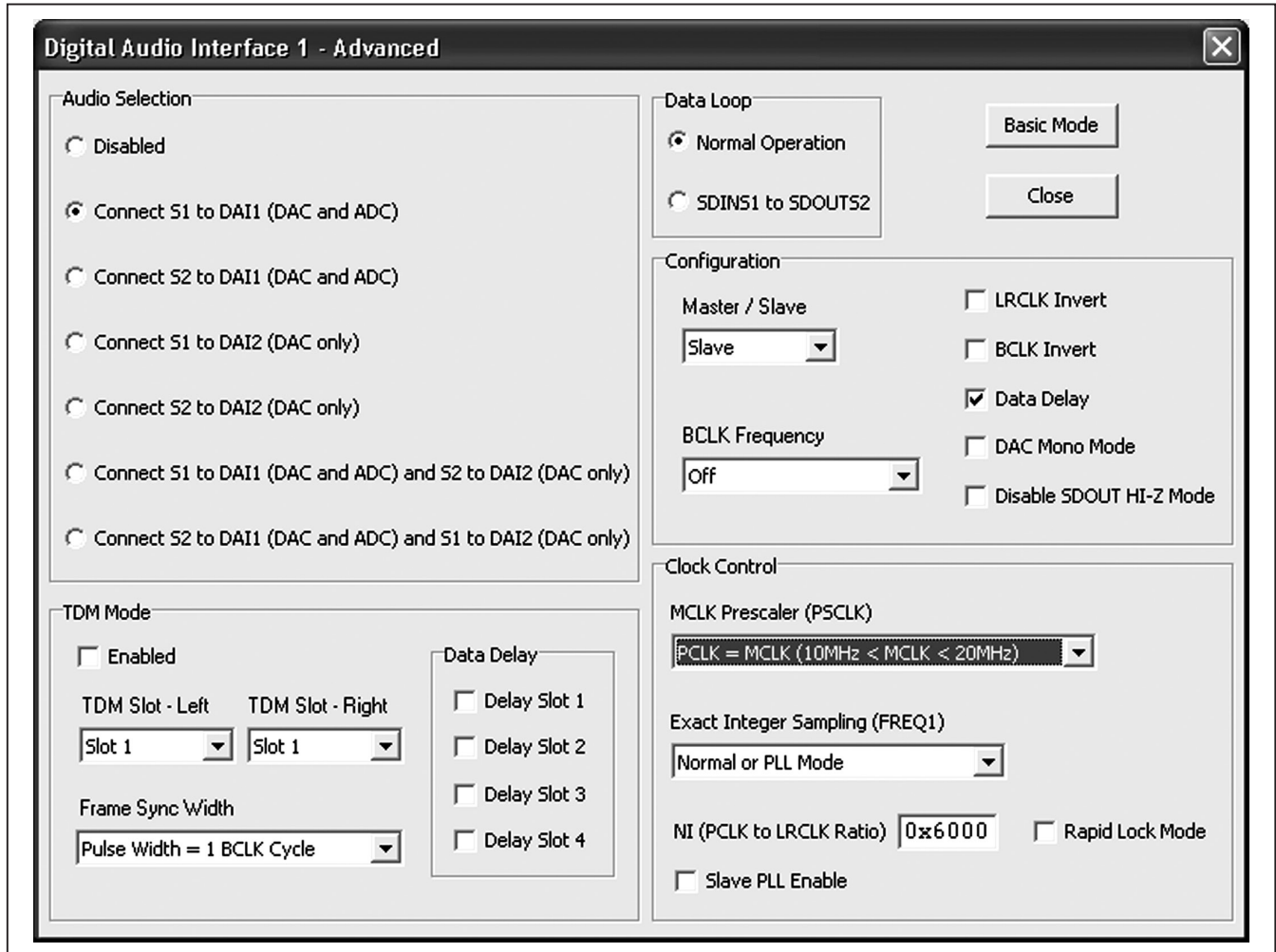

Figure 9. Digital Audio Interface 1 - Advanced Window

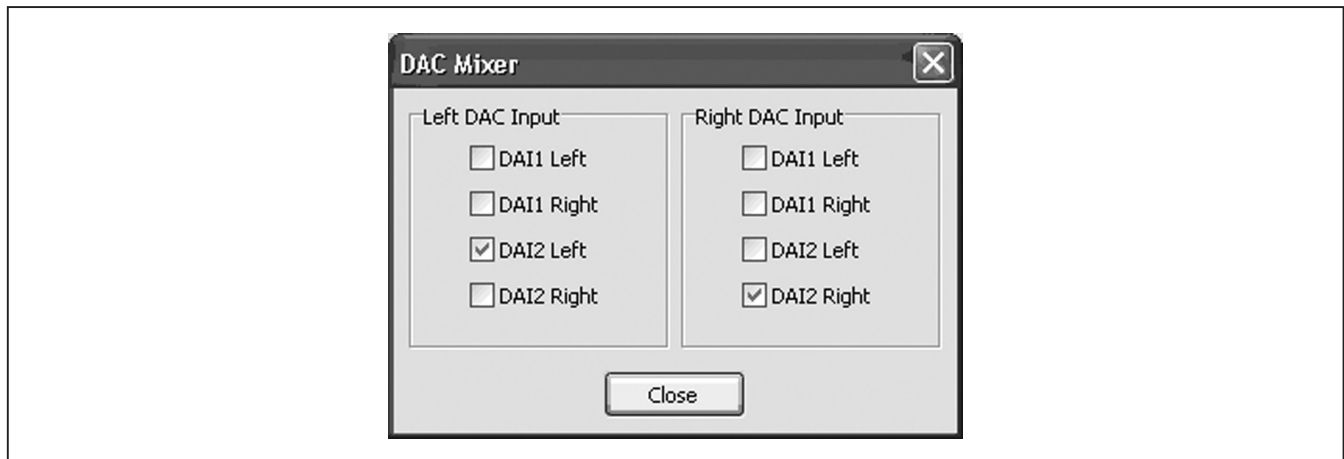

Figure 10. DAC Mixer Window



# MAX9880A Evaluation Kit

paths is accessed by selecting either of its Filtering blocks and filtering for the DAI2 signal path is enabled/disabled by clicking its associated Filtering block.

The DAI1 **Filtering** blocks open the **DAI1 Filtering** window. The **Filtering Mode** radio buttons configure the filtering mode for DAI1's DAC and ADC signals. When the **Voice Filters (IIR)** radio button is selected, group boxes for the ADC Digital Audio Filter (**ADC Highpass Filter**) and DAC Digital Audio Filter (**DAC Highpass Filter**) registers are visible, providing a selection of five highpass filter types. When the **Audio Filters (FIR)** radio button is selected, a DC-blocking filter is available. The ADC and DAC DC-blocking filters are enabled/disabled by selecting/deselecting the appropriate checkbox. The DC-blocking filter for the DAI2 path is enabled/disabled by clicking on the DAI2 **Filtering** block.

The DAI1 and DAI2 **Filtering** blocks are also used to display the current state of their digital filters (see Figure 11). The filter blocks display an image, representing the type of filtering (highpass or DC blocking) being applied to the DAI\_ signals. In addition, the DAI1 **Filtering** blocks display the configured filtering mode (voice filters or music filters).

## SPDM Output Registers

The SPDM Configuration and Input registers are accessed through the **SPDM CLOCK**, **SPDML**, and **SPDMR** blocks on the **Digital Audio** tab (see Figure 12). These blocks are used to enable/disable the SPDM data outputs and configure the SPDM clock rate (SPDMCLK). The SPDM input mixers (MIXSPDML, MIXSPDMR) are configured by selecting the **MIX** block associated with the SPDMDATA output.

To utilize the SPDM data output, configure the EV kit hardware as described in the *SPDM Output* section.

## Digital Gain Registers

The digital gain registers are accessed by selecting the appropriate gain blocks on the **Digital Audio** tab (see Table 10). The Voice DAC Level register is divided into two gain blocks. The first gain block is for DAC gain and the second is for DAC muting and level control. The gain block coming from the ADC **Filtering** block opens the **ADC Level Control** window, providing access to both the ADC gain and level-control settings.

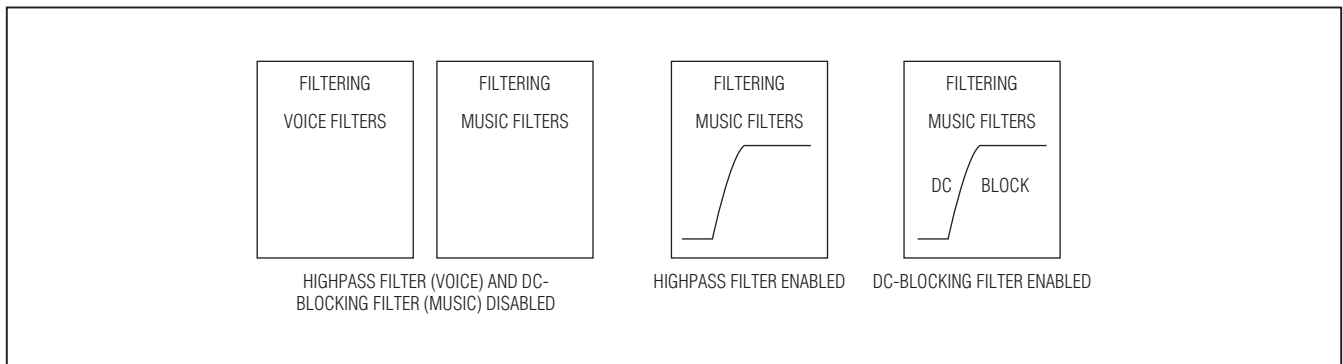

Figure 11. DAI\_ Filtering Blocks

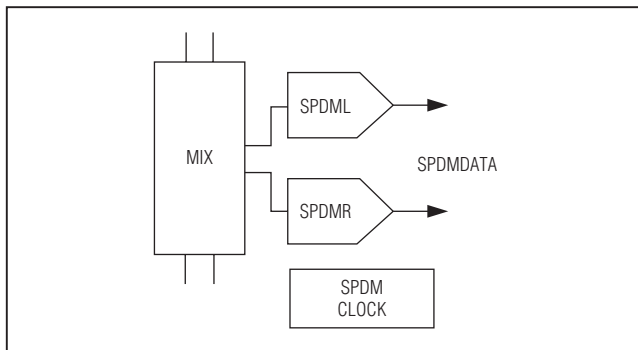

Figure 12. SPDM Blocks

Table 10. Digital Gain Blocks

REGISTER	GUI BLOCK(S)
Sidetone	<b>Sidetone</b> gain block
Stereo DAC Level	Gain block from the <b>Digital Interface 2</b> block
Voice DAC Level	Gain blocks from the <b>Digital Interface 1</b> block
Left ADC Level	Gain block from the ADC <b>Filtering</b> block
Right ADC Level	

# MAX9880A Evaluation Kit

Evaluates: MAX9880A

## Line Input Registers

The mute and gain settings for the line inputs (LINL and RINL) are accessed by selecting the first gain block on their respective input signal path. The gain blocks open the **Left Line Input** and **Right Line Input** windows, each of which provides controls to mute, enable, and configure the gain of the respective line input.

## Playback Volume Registers (Line inputs, DAC inputs)

The second gain block on the LINL and RINL inputs opens the **Left/Right Volume Control** window that is

used to configure the Left Volume Control and Right Volume Control registers (see Figure 13). These registers control the mute and playback volume settings for both the DAC and line input audio signals. As such, this window is also accessible from the **Digital Audio** tab by selecting the gain blocks going into the DAI\_ DAC **Filtering** blocks.

The volume control window also provides the option to synchronize the left and right settings. When the **Sync Right and Left** checkbox is selected, the **Left Playback Volume** slider and **Mute** checkbox configure both the left and right playback volumes.

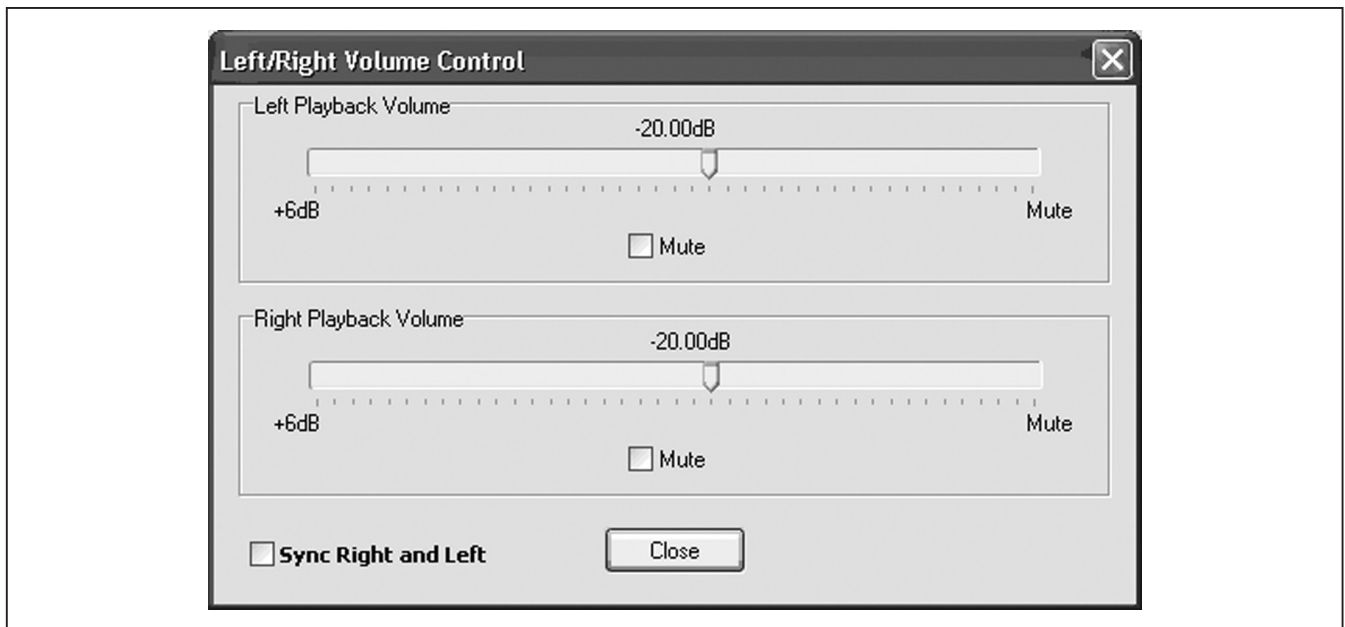

Figure 13. Left/Right Volume Control Window



# MAX9880A Evaluation Kit

## Line Output Registers

The mute and gain settings for the line outputs (LOUTL, LOUTR) are accessed by selecting the outputs' gain block. The gain blocks open the **Left Line Output Gain** and **Right Line Output Gain** windows, each of which provides controls to mute and configure the gain of that line output. See Figure 14 for the **Left Line Output Gain** window. The windows also provide checkboxes to enable/disable the Mode register (0x24) bits, digital volume slew speed (DSLEW), smooth volume changes (VSEN), and change on zero-crossings (ZDEN). Refer to the MAX9880A IC data sheet for register details.

The line output gain windows also provide the option to synchronize the left and right output settings. When the **Sync Right and Left** checkbox is selected, only one line output gain window should be open, as this single window configures both the left and right line output gains.

## Microphone Input Registers

The MICL and MICR microphone inputs are routed through two gain stages, preamplifier gain and programmable gain amplifier, to the ADCs. These gain stages are accessed by selecting the two gain blocks associated with the microphone signal paths. The first gain block opens a **Microphone Pre-Amp** window that is used to

enable/disable the analog microphone circuitry and set the preamplifier gain. The **Microphone Pre-Amp** windows also support synchronization between the left and right microphone settings.

The second gain blocks open the **Left** and **Right MIC PGA** windows, which provide a slider and edit box for configuring the programmable gain amplifiers. These windows also include a **Change on Zero Crossings** checkbox that sets/clears the zero-crossing detection bit (ZDEN) of the Mode register (0x24).

When the left or right digital microphones are enabled, the left analog microphone input (MICL) is not available. Refer to the *Digital Microphone Input* and *Microphone Inputs* sections in the MAX9880A IC data sheet for more information.

## Microphone Bias Register

The microphone bias register bit (MBIAS) is accessed by selecting the **MICBIAS** block on the **Analog Audio** tab. The **MIC Bias Voltage** window provides two configuration options for the microphone bias voltage (1.525V and 2.2V). The microphone bias is enabled when the PALEN or PAREN bits of registers 0x20 and 0x21, respectively, are set.

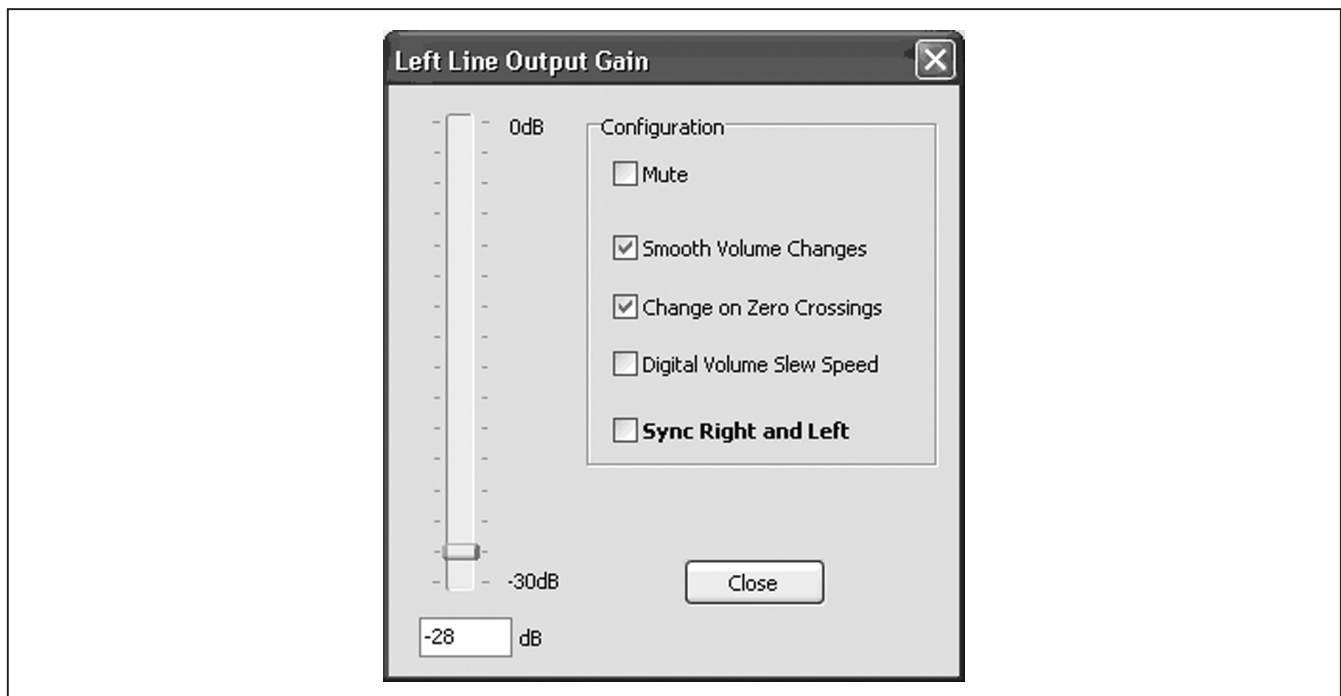

Figure 14. Left Line Output Gain Window

# MAX9880A Evaluation Kit

## ADC Input Register

The ADC input register is used to configure the ADC audio input mixers, as well as configure, enable, and utilize the device's auxiliary input (AUX). The **ADC Left** and **Right Input Mixer** windows are accessed by selecting the **MIX** blocks associated with the **Left** and **Right ADC** on the **Analog Audio** tab. The AUX controls are provided on the **Auxiliary Configuration** window, which is accessed by selecting the **AUX[15:0]** block (see Figure 15).

## Audio Input Mixers

The left and right input mixers can be configured to mix audio signals from the analog microphones, single-ended line inputs, or a combination of both inputs. If an input mixer is configured to mix the right line input and the right line input is disabled, then the left line input is routed to both mixers. This logic is reflected by the input labels displayed on the ADC **MIX** blocks.

When an input for the ADC input mixers is selected, the associated ADC **MIX** block is highlighted blue to indicate

that this section of the signal path is configured. Note that when the digital microphone input is enabled, the corresponding input mixer is disabled (i.e., if the left/right digital microphone is enabled, the left/right ADC audio input mixer is disabled).

The input mixer windows also provide the option to synchronize the left and right input mixers. When the **Sync Right and Left** checkbox is selected, only one input mixer window should be open, as this single window configures both the left and right input mixers.

## Auxiliary Input

The auxiliary input is a secondary function of the device's JACKSNS pin and is configured through the **Auxiliary Configuration** window (Figure 15). The auxiliary input is used to perform ADC measurements of an external DC voltage applied to the AUX pad. See the **JACKSNS/AUX** section for details on configuring the EV kit hardware for auxiliary input DC measurements.

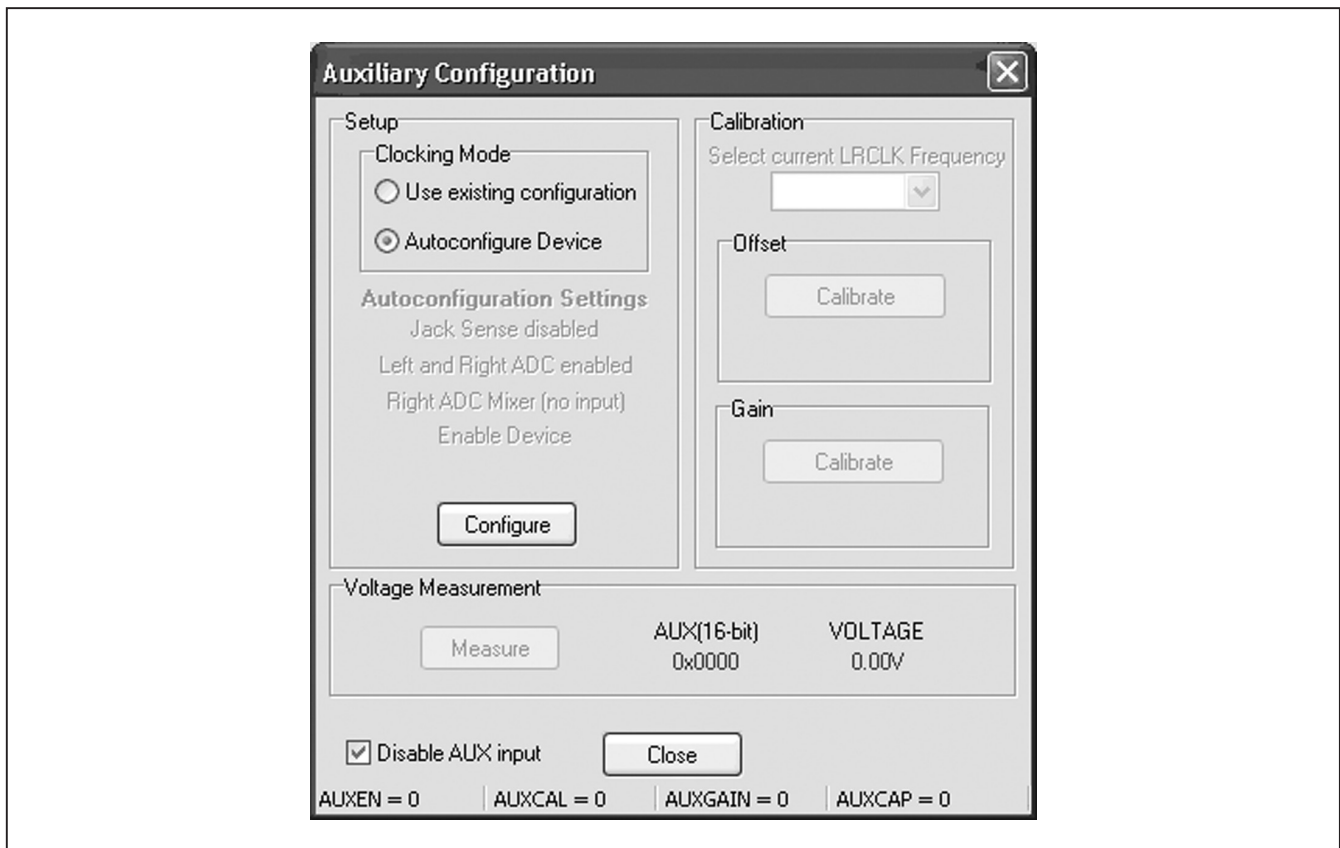

Figure 15. Auxiliary Configuration Window

# MAX9880A Evaluation Kit

The two top group boxes (**Setup** and **Calibration**) represent the procedures for properly configuring the ADC for performing DC voltage measurements. The first time this window is opened, the **Calibration** and **Voltage Measurement** group boxes are disabled. This is intentional and ensures that the ADC gets properly configured before the first DC measurement is taken. Refer to the *ADC* section in the MAX9880A IC data sheet for detailed steps for configuring the device.

The **Setup** group box contains a **Clocking Mode** group box that provides radio buttons to determine how the device should be set up. As there are specific device-configuration requirements, the **Autoconfigure Device** option is recommended, unless it is known that the current device configuration meets the setup requirements. The disabled labels are associated with the autoconfiguration option and display the settings that are applied once the **Configure** button is pressed.

Once the configuration is complete, the **Offset** group box is activated, enabling the second step, offset calibration. If the **Use existing configuration** (manual operation) is selected, the **Select current LRCLK Frequency** drop-down list is also activated; otherwise, it stays disabled. Pressing the offset **Calibrate** button executes the procedure listed in the *Offset Calibration Procedure* section of the MAX9880A IC data sheet.

Once the offset calibration sequence is complete, the **Gain** group box is activated, enabling the final step, gain calibration. Pressing the gain **Calibrate** button executes the procedure listed in the *Gain Calibration Procedure* section of the MAX9880A IC data sheet. The result (K) of the gain calibration is displayed below the gain **Calibrate** button.

After the calibration sequences are completed, the **Voltage Measurement** group box is activated and the device is ready to perform DC measurements. Pressing the **Measure** button executes the procedure listed in the *DC Measurement Procedure* of the MAX9880A IC data sheet. The result is displayed both as a voltage and a 16-bit hex value. Additional DC measurements are performed by pressing the **Measure** button again.

## Digital Microphone Input Register

Using the on-board digital microphones requires both hardware and software configuration. See the *Microphone Inputs* section for hardware configuration options. For software configuration, select the **DIG MIC** block on the **Analog Audio** tab. The digital microphone clock is set by selecting one of the radio button options, and the left/right digital microphone inputs are enabled by checking the corresponding checkbox on the **Digital Microphone Input** window. When using either of the digital microphone inputs, the left analog microphone input is not available. Similarly, the left/right ADC input mixers are disabled when the left/right digital microphones are enabled.

## Mode Register

The Mode register is used to configure slew speed (DSLEW), volume-change smoothing (VSEN), line input zero-crossing detection (ZDEN), and headphone amplifier mode (HPMODE). The DSLEW, VSEN, and ZDEN settings are configurable through the **Left Line Output Gain** and **Right Line Output Gain** windows; additionally, the ZDEN setting can be configured through the **Left MIC PGA** and **Right MIC PGA** windows.

## Headphone Modes (HPMODE)

The headphone amplifier mode is configured by selecting either of the headphone output amplifier blocks and selecting one of the eight headphone amplifier modes. Once a selection is made, the headphone image changes to display the current headphone configuration. Figure 16 shows images for two of the eight possible headphone configurations, stereo capless and stereo single-ended. The EV kit hardware should also be configured to match the software-selected headphone configuration (see the *Headphone Outputs* section).

## Jack Detection

Jack detection is configured and monitored on the **Jack Detect/Jack Status** window, which is accessed by selecting the **JACKSNS** block on the **Analog Audio** tab. This window provides access to both the Jack Detect register (0x25) and the Jack Status register (0x01). Also note that the JDET bit of the Status register (0x00) is displayed in the **Status** group box at the top of the main software window. See Table 11 for jack detect/jack status controls.

# MAX9880A Evaluation Kit

Evaluates: MAX9880A

## Enable Register

The Enable register provides enables for the left/right line inputs, left/right line outputs, and left/right DACs and ADCs. The line input and output enables are accessed from **Left Line Input** and **Right Line Input** windows and the line outputs are configurable through the **Left Line Out Enable** and **Right Line Out Enable** windows. Figure 17 shows which GUI blocks provide access to the line input and line output enables.

The left and right DAC and ADC enables are accessed by selecting the DAC and ADC blocks available on both the **Analog Audio** and **Digital Audio** tabs. Note that when enabling the right DAC/ADC, the left DAC/ADC should also be enabled.

## System Shutdown Register

The register's **SHDN** bit is used to place the device in a lower-power shutdown mode. This feature is controlled by the **MAX9880A Power** button at the top of the main software window. This register is also used to configure the device crystal oscillator. This is configured by selecting the **CRYSTAL** block on the **Digital Audio** tab.

## Device Revision ID

The device's revision ID is stored in registers 0x14 and 0xFF. After the software has established a connection to the EV kit and device, it reads one of these two registers to determine the device's revision ID. In SPI mode, the 0x214 (0x14 in I<sup>2</sup>C mode) register is read, and in I<sup>2</sup>C mode the 0xFF register is read. If the revision ID is not recognized, the software displays a dialog box informing that a noncompatible device has been detected.

**Note:** When in SPI mode, the 0xFF register is not accessible.

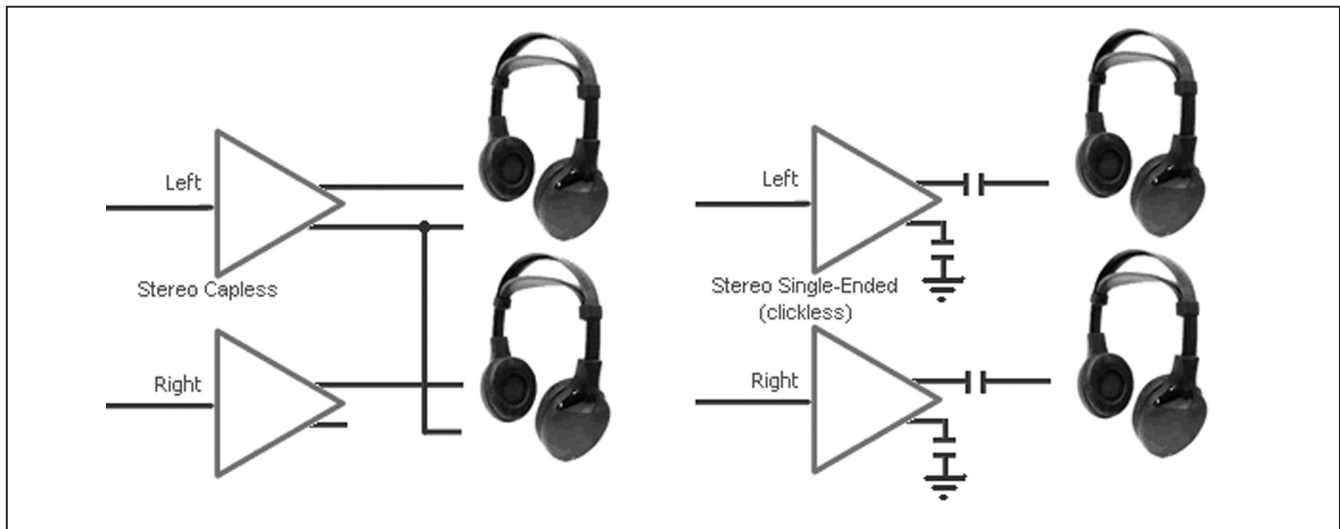

Figure 16. Headphone Modes (2 of 8)

**Table 11. Jack Detect/Jack Status Controls**

GUI CONTROL	DESCRIPTION
<b>Jack Detection</b> radio buttons	Configures JD TEN bit (enable: JD TEN = 1).
<b>Jack Detect Debounce</b> radio buttons	Configures the JDEB bits.
<b>Jack Sense</b> group box	Displays the status of the JACKSNS bits. This requires that Jack Detection be enabled (JD TEN = 1).
<b>Jack Action</b> group box	Displays the results of the Jack Detection logic, when JD TEN = 1.
<b>Jack Sense Weak Pullup</b> group box	Configures the JDWK bit.

# MAX9880A Evaluation Kit

## Save/Load Settings

Register configurations can be saved/loaded by selecting the **Save Settings CTRL+S** or **Load Settings CTRL+O** menu item from the **File** menu bar. The save operation saves the state of the U1 device registers, S/PDIF transceiver (U11) registers, and a few general-purpose input-output (GPIO) settings to a configuration file. The load operation configures the U1 and U11 device registers and sets/clears specific GPIO pins based on the data and settings contained in the configuration file.

A Configuration 1.ax27 file is included in the MAX9880A software directory and contains the data and settings that result from performing the procedure in the *Quick Start* section. The default and recommended file extension is .ax27.

## Advanced User Interface

The **Advanced User Interface** window can also be used to communicate with the U1 and U11 devices. Use the **Tools | Interface (Advanced Users) F1** menu item to open the interface window, which can be used for SPI communication, I<sup>2</sup>C/SMBus™ communication, and to control the MAXQ2000 GPIOs that the EV kit utilizes. This window consists of four main tabs: **Connection**, **Bit Set/Clear**, **2-wire Interface**, and **3-wire Interface** (see Figure 18). The interface utility only accepts and outputs hexadecimal number format.

## Connect

The **Connection** tab is used to establish a connection with the MAXQ2000 interface included on the EV kit.

## Bit Set/Clear

The **Bit Set/Clear** tab provides control of the MAXQ2000's available GPIO pins. The only GPIO pins utilized by the EV kit are listed in Table 12, along with their functionality.

## 2-Wire Interface

The **2-wire interface** tab's **General commands** tab (Figure 19) allows general-purpose 2-wire commands to be sent using the **Command (SMBus Protocols, Raw Block Read/Write, EEPROM Read/Write)** drop-down list and the **Execute** button. The read/write commands to use with the U1 device are **SMBusWriteByte** and **SMBusReadByte**. The **SMBusWriteByte** transmits the device address, command, and 1 byte of data. The **SMBusReadByte** transmits the device address, a command, and then retransmits the device address and reads 1 byte of data.

The device address used by the commands is the value displayed in the **Target Device Address** drop-down list, which is generated by pressing the **Hunt for active listeners** button. This button scans the entire 2-wire address space, reporting each address that is acknowledged. For both a read and write operation, the **Command Byte** is the register address. The data to write to the target device should be entered in the **Data Out** field and the data that is read is reported in the **Data In** field. The SCL frequency can also be configured by selecting the **Low Level commands** tab and using the speed buttons and/or edit fields to set the operating frequency.

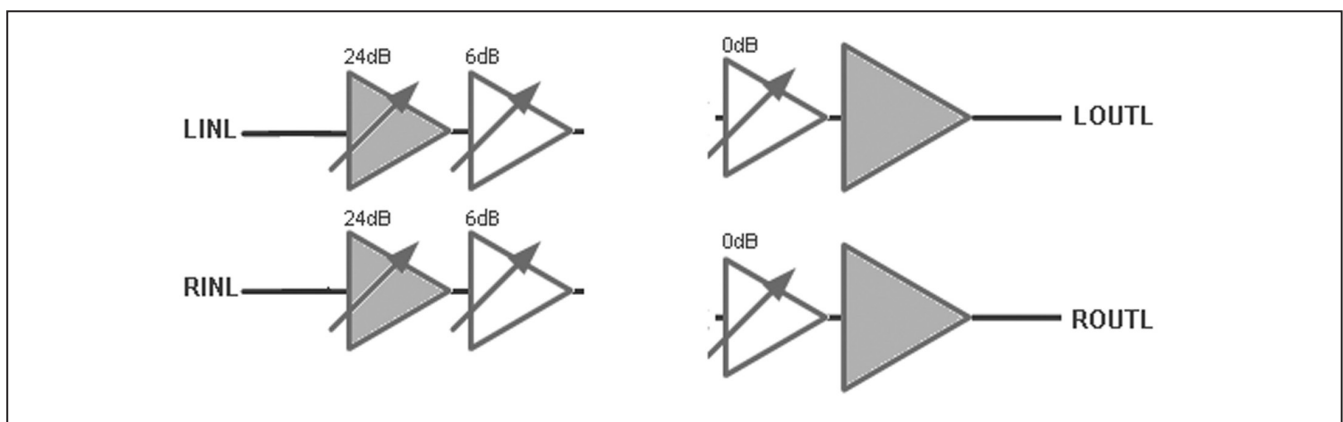

Figure 17. Line Input and Output Enable Blocks

SMBus is a trademark of Intel Corp.



# MAX9880A Evaluation Kit

Evaluates: MAX9880A

**Table 12. GPIO Functionality**

MAXQ2000 GPIO	NET NAME	I/O	FUNCTIONALITY
K1	9880A_IRQ	Input	Used to monitor the U1 device's IRQ pin.
K2	CS2	Output	Chip select for U1 device's SPI interface.
K3	CONNECT	Output	Enables/disables PC detection of the USB audio DAC (U12).
K4	CS8427_RST	Output	Controls the RST pin of the digital audio interface transceiver (U11).
K5	9880A_SELECT	Input	Used to poll the U1 device's SELECT pin.

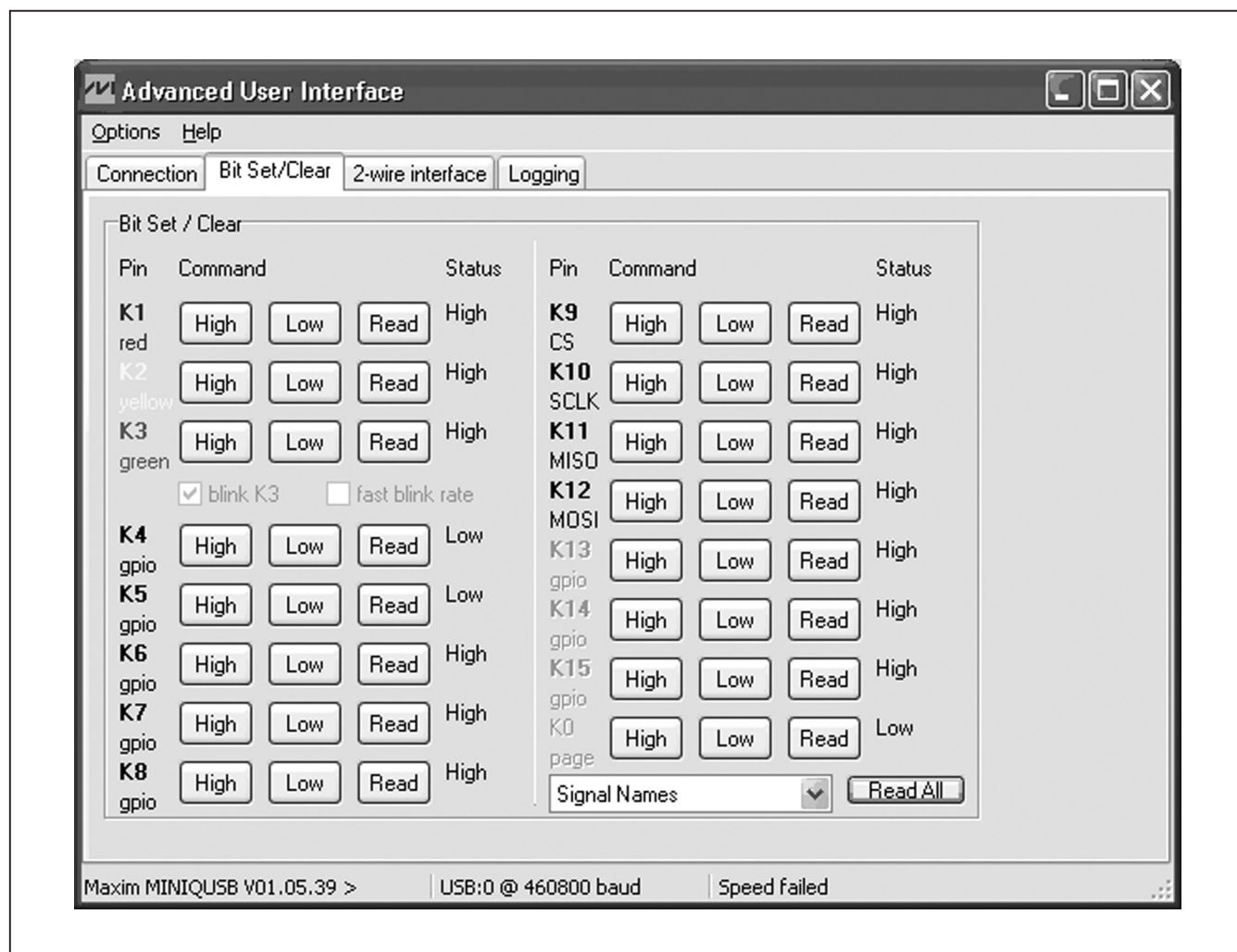

Figure 18. Advanced User Interface (Bit Set/Clear Tab)

# MAX9880A Evaluation Kit

## SPI Interface

The SPI interface is configured and used by selecting the **3-wire Interface** tab. The **Connection** and **Configuration** group boxes are used to configure the SPI interface. The EV kit's SPI connections and default interface configuration are shown in Table 13 and Figure 20, respectively.

The SPI interface can be used to read and write to the U1 and U11 devices. The slave device is selected by configuring K2 (U1, CS2) or K9 (U11, CS1) as the interface's

chip-select. Refer to the MAX9880A and CS8427 IC data sheets for additional SPI information.

To communicate with the U1 device, enter the 24-bit (3-byte) SPI frame into the **Data bytes to be written** edit box and press the **Send Now** button. For a read operation, the data received is displayed in the **Data bytes received** edit box. Refer to the *Serial Peripheral Interface (SPI)* section in the MAX9880A IC data sheet for additional information.

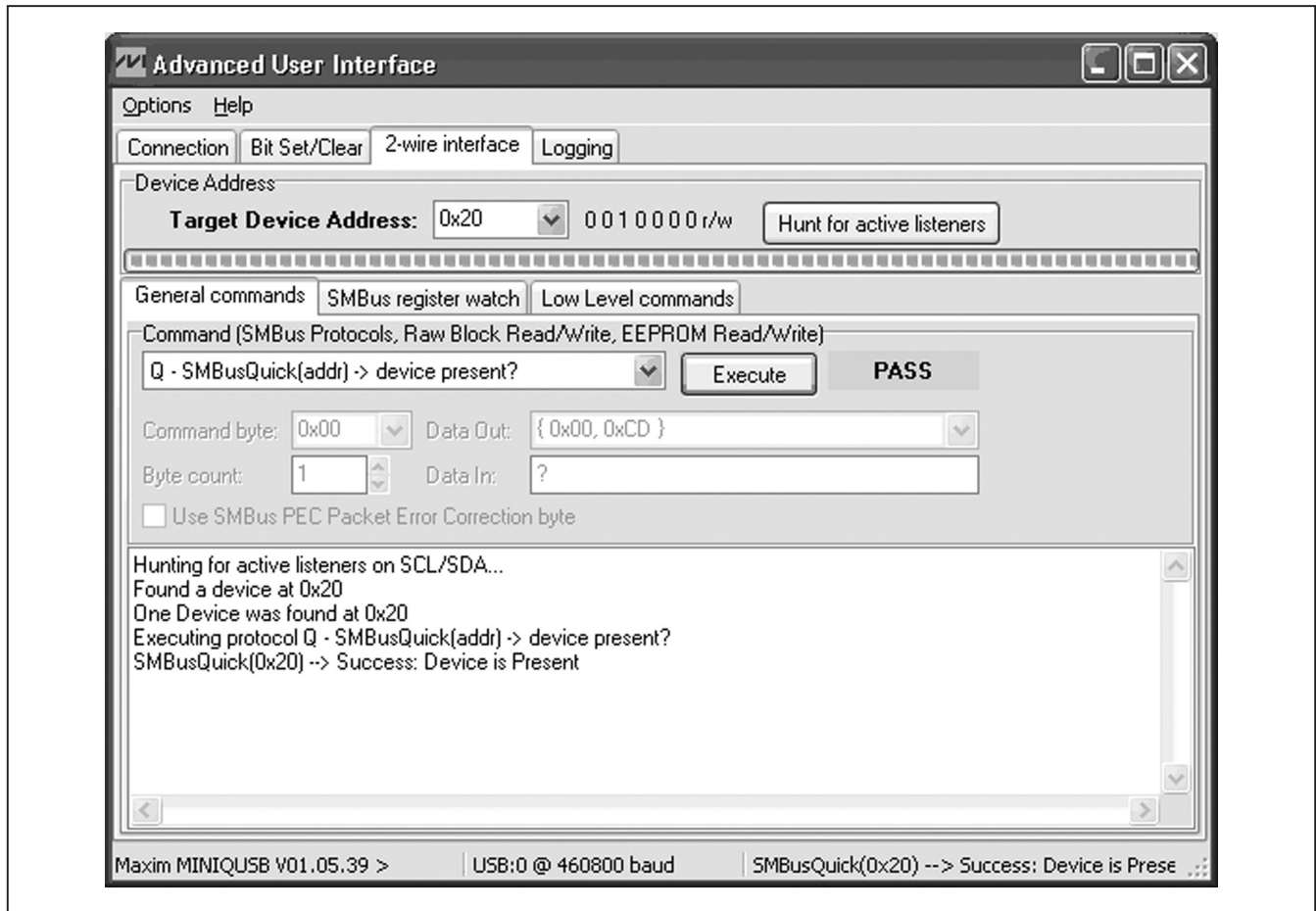

Figure 19. Advanced User Interface (2-Wire Interface Tab's General Commands Tab)



# MAX9880A Evaluation Kit

Evaluates: MAX9880A

## Detailed Description of Hardware

The MAX9880A EV kit evaluates the MAX9880A low-power, high-performance, stereo audio codec with audio processing (U1). The EV kit includes input and output RCA connections, capless and single-ended headphone connectors (J3, J4), and two on-board digital microphones (U15, U16). The EV kit also includes USB-powered low-dropout (LDO) linear regulators that allow the EV kit to be evaluated without any external supplies. These LDOs provide the 1.8V and 3.3V voltages required by the U1 device and support circuitry.

Integrated into the EV kit design is a digital audio transceiver (U11) and a USB stereo audio DAC (U12). The digital audio transceiver provides audio input and output through the on-board TOSLINK connectors (J5, J6), and the USB stereo audio DAC provides audio input through the mini-USB connector (J10).

The EV kit also includes a MAXQ2000 microcontroller (U5) that interfaces with the U1 device's I2C and SPI control bus and allows the EV kit to be evaluated with the EV kit software. See the *Detailed Description of Software* section.

**Table 13. SPI Interface**

MAXQ2000 SPI INTERFACE	MAXQ2000 GPIO	NET NAME	FUNCTION
SEG1/P0.1	K2	CS <sub>2</sub>	Chip select for the U1 SPI interface
P5.4/SS	K9	CS <sub>1</sub>	Chip select for the U11 SPI interface
P5.6/SCLK	K10	CCLK	SPI SCLK clock
P5.7/MISO	K11	MAXQ_MISO	Master in/slave out
P5.5/MOSI	K12	CDIN	Master out/slave in

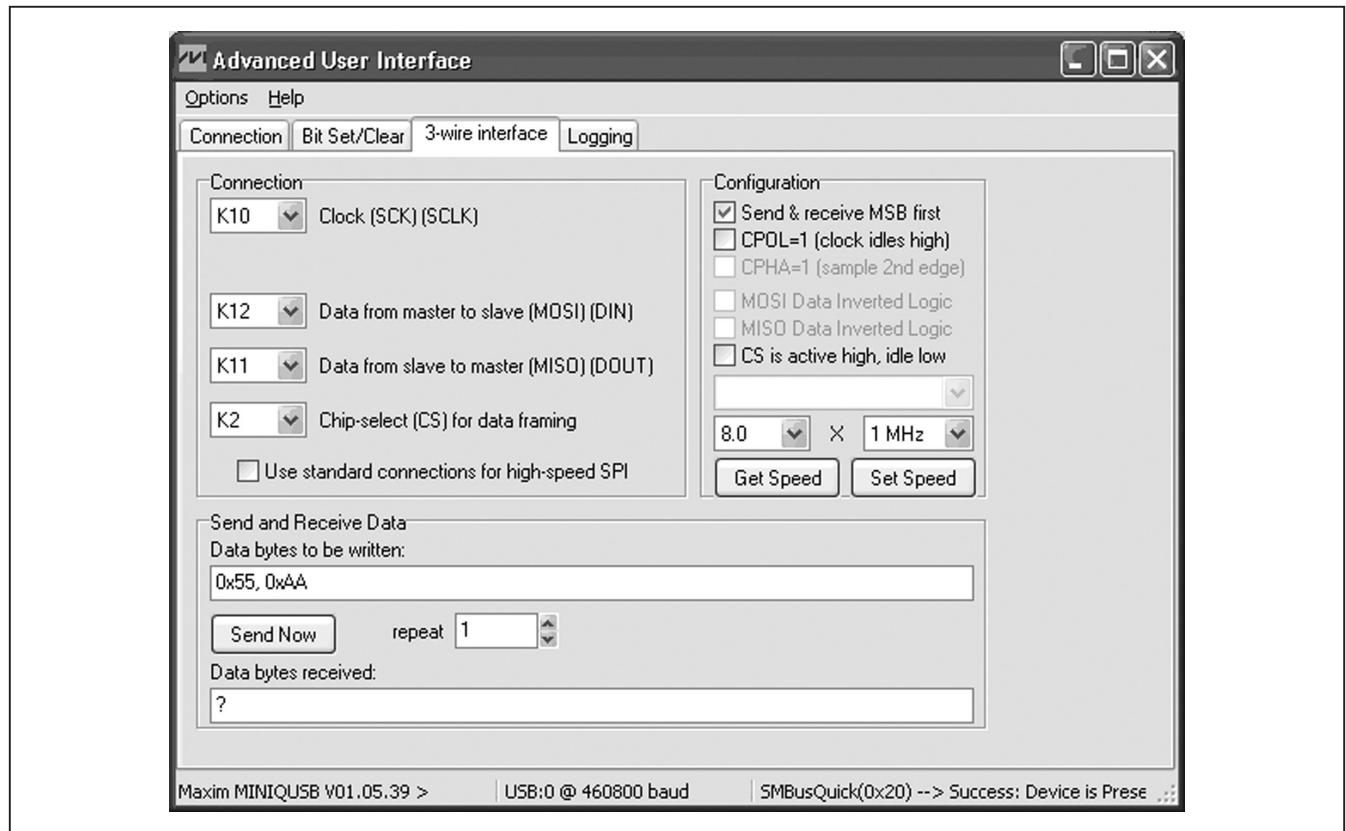

Figure 20. Advanced User Interface (3-Wire Interface Tab)

# MAX9880A Evaluation Kit

## Master Clock (MCLK)

The EV kit provides jumper JU12 to select the source of the device's master clock input (see Table 14). The MCLK input can be connected to GND, RMCK, FUNC2, or the on-board 13MHz crystal oscillator (Y2). When connected to RMCK or FUNC2, the clock signal is provided by the digital audio transceiver or the USB stereo audio DAC, respectively.

## Interface Configuration (JU21)

The U1 device is configured for I<sup>2</sup>C/2-wire or SPI operation through jumper JU21 (see Table 15). Once the interface mode is configured, the shunts on headers JU20 and JU27 need to be configured, as shown in Table 16. Note that the JU20 and JU27 headers should be configured in an exclusive-or manner (i.e., only one header is shunted at a time). Once all three headers are properly configured, the PC-based EV kit software can be used to configure and control the device. See the *Detailed Description of Software* section.

Refer to the *Serial Peripheral Interface (SPI)* and *I<sup>2</sup>C Serial Interface* sections in the MAX9880A IC data sheet for additional SPI and I<sup>2</sup>C details.

## Microphone Inputs

The U1 device can be evaluated with digital microphones and/or analog microphones. The EV kit provides the capability to evaluate the device with only digital microphones, only analog microphones, or a combination of both types (see Table 17). The left analog microphone connects across the MICLN and MICLP pads and the right analog microphone connects across the MICRN and MICRP pads. Both single-ended and differential analog microphones can be used with the EV kit (see Table 18). Two digital microphones (U15, U16) are included on the EV kit and are connected to the device's left microphone inputs (MICLN, MICLP) through jumpers JU8 and JU9.

## Microphone Bias (JU3, JU4)

The U1 device's microphone bias (MICBIAS) output can be used to power two external analog microphones by installing shunts on jumpers JU3 and JU4. If digital microphones are used remove the shunt from jumper JU4.

When using the digital microphones, remove the shunts from jumpers JU5 and JU6 and leave the left microphone input pads (MICLN, MICLP) unconnected. Similarly, when using the SPDM output, remove the shunts from jumpers JU1 and JU2 and leave the right microphone input pads (MICRN, MICRP) unconnected. See the *SPDM Output* section.

**Table 14. JU12 Function**

SHUNT POSITION	U1 MCLK INPUT	FREQUENCY
1-2	Connected to ground	—
1-3	Connected to pin 10 (RMCK) of U11	MCLK = 256 x S/PDIF input sample rate
1-4*	Connected to on-board crystal oscillator Y2	MCLK = 13MHz
1-5	Connected to pin 18 (FUNC2) of U12	MCLK = 256 x USB input sample rate

\*Default position.

**Table 15. JU21 Function**

SHUNT POSITION	U1 SELECT PIN	DESCRIPTION
Installed*	Connected to ground	U1 device interface = I <sup>2</sup> C/2-wire
Not installed	Connected to DVDDIO through resistor R39	U1 device interface = SPI

\*Default position.

**Table 16. JU20 and JU27 Function**

U1 INTERFACE	SHUNT POSITION		DESCRIPTION
	JU20	JU27	
I <sup>2</sup> C/2-wire*	Pins 2-3 of each row*	Not installed*	The U1 device's I <sup>2</sup> C interface is connected to the EV kit's I <sup>2</sup> C control bus.
SPI	Not installed	Pins 2-3 of each row	The U1 device's SPI interface is connected to the EV kit's SPI control bus.

\*Default position.

# MAX9880A Evaluation Kit

## SPDM Output

The U1 device provides an SPDM output by retasking the MICRN and MICRP device pins. This feature is selectable through I<sup>2</sup>C and is accessed through the **SPDM** blocks on the **Digital Audio** tab. When utilizing the SPDM output, the MICRN and MICRP pads cannot be used for microphone input and shunts should be removed from jumpers JU1 and JU2.

To access the SPDM output signals, shunts must be installed on jumpers JU18 and JU24. This configuration connects the SPDM output (SPDMDATA, SPDMCLK) to the DSD\_DATA and DSD\_CLK pads.

## JACKSNS/AUX

The U1 device's JACKSNS/AUX pin has dual functionality, allowing it to be used as an input for jack detection, or as an input for measuring DC voltages.

### Jack Detection (JACKSNS)

To utilize this feature, configure jumper JU7 according to Table 19, disable the **AUX** block on the **Analog Audio** tab, and refer to the *Mode Configuration* section in the MAX9880A IC data sheet for additional details and configuration options. Once the EV kit is configured for jack detection, there is one of three methods for utilizing this feature: through the JACKSNS pad, through the J3 headphone jack, or through the MICLP pad, which requires that a shunt be installed on jumper JU29.

**Table 17. Microphone Input Configuration**

SHUNT POSITION		MICROPHONE INPUTS	DESCRIPTION
JU8	JU9		
Not installed	Not installed	Two analog microphones*	Analog microphones connected across MICLN, MICLP, MICRN, and MICRP pads.
Installed	installed	Two digital microphones	On-board digital microphones (U15 and U16) connected to device's left microphone inputs.
Installed	Installed	Analog and digital microphones	On-board digital microphones (U15 and U16) connected to left microphone inputs and analog microphone connected across MICRN and MICRP pads.

\*Default position.

**Table 18. Analog Microphone Configuration**

ANALOG MICROPHONE	SHUNT POSITION					
	JU1	JU2	JU5	JU6	JU3	JU4
Single-ended (without MICBIAS)	X	Installed	Installed	X	Not installed	Not installed
Single-ended (with MICBIAS)	X	Not installed	Not installed	X	Installed	Installed
Differential (without MICBIAS)	Installed	Not installed	Not installed	Installed	Not installed	Not installed
Differential (with MICBIAS)	Installed	Not installed	Not installed	Installed	Installed	Installed

X = Don't care.

**Table 19. JU7 Function**

SHUNT POSITION	U1 JACKSNS/AUX PIN	MODE
Installed	Connected to the JACKSNS pad	Jack detection
Not installed*	Connected to the AUX pad through resistor-dividers R5 (10k $\Omega$ ) and R6 (10k $\Omega$ )	DC voltage measurements

\*Default position.

# MAX9880A Evaluation Kit

## Measuring DC Voltages (AUX)

To utilize this feature, configure jumper JU7 according to Table 19, remove the shunt from jumper JU29, ensure that a headphone plug is not plugged in to jumper JU3, and enable the **AUX** block on the **Analog Audio** tab, and refer to the *ADC* section in the MAX9880A IC data sheet for setup and configuration details. The applied DC voltage ( $V_{AUX}$ ) is divided down before measured by the device's ADC. The measured DC voltage ( $V_{DC}$ ) is:

$$V_{DC} = \frac{R5}{(R5 + R6)} \times V_{AUX}$$

where the default divider ratio is equal to 1/2.

## Audio Inputs and Outputs

The U1 device's audio inputs and outputs are routed to the various connectors, headers, and pads on the EV kit. Table 20 lists the audio input connections and Table 21 lists the audio output connections. Refer to the MAX9880A IC data sheet and EV kit software for audio signal routing details (i.e., which audio inputs can be routed to the available audio outputs).

## Headphone Outputs

The U1 device supports three headphone output modes, single-ended, differential, and capacitorless. All three modes can be evaluated using the ROUT\_ and LOU\_

pads provided on the EV kit, in conjunction with the JU10 and JU11 jumpers. Refer to the *Headphone Modes* section of the MAX9880A IC data sheet.

To facilitate evaluation with single-ended and capacitorless output modes, the EV kit provides two 3.5mm headphone jacks (J3, J4). The J4 headphone jack is configured for capacitorless output mode and the J3 headphone jack is configured for single-ended output mode.

## On-Board LDOs

The EV kit includes on-board LDO linear regulators (U6, U8, U9, and U10), allowing the EV kit to operate without external power supplies. These LDO regulators provide power to the U1 device's power-supply pins: DVDD, MICVDD, PVDD, AVDD, and DVDDS1. The LDO regulator outputs can be isolated from the power-supply pins through jumpers JU14–JU17, and JU22, respectively.

A fifth LDO linear regulator (U7) provides power to the MAXQ2000 circuit, level translators (U4, U17), crystal oscillator (Y2), stereo digital audio transceiver (U11), USB stereo audio DAC (U12), and S/PDIF connectors (J5, J6). All the LDO linear regulators are powered by the USB bus voltage (+5V) from the J7 mini-USB connector.

**Table 20. Audio Inputs**

AUDIO INPUT	U1 PIN	DESCRIPTION
J1	LINL	Single-ended left line input (LINEINL)
J2	LINR	Single-ended right line input (LINEINR)
J6	S1 interface*	S/PDIF audio input from U11
J10	S2 interface*	USB audio input from U12
MICL_ pad	MICL_	Left analog microphone
MICR_ pad	MICR_	Right analog microphone
U15	MICL_	Left digital microphone (DIGMIC_)
U16	MICL_	Right digital microphone (DIGMIC_)

\*S\_ interface pins = SDOUTS\_, SDINS\_, BCLKS\_, and LRCLKS\_.

**Table 21. Audio Outputs**

AUDIO OUTPUT	U1 PIN	DESCRIPTION
J3	ROUTP and LOU_ TP	Single-ended headphone output with jack detection
J4	ROUTP, LOU_ TP, and LOU_ TN	Capless headphone output
J5	S1 interface*	S/PDIF audio output on U11
J8	LOU_ TR	Single-ended line output (OU_ TR)
J9	LOU_ TL	Single-ended line output (OU_ TL)
ROUT_ pads	ROUT_	Right headphone output
LOU_ pads	LOU_	Left headphone output

\*S\_ interface pins = SDOUTS\_, SDINS\_, BCLKS\_, and LRCLKS\_.

# MAX9880A Evaluation Kit

## Digital Audio Interfaces (S1, S2)

The two digital audio interfaces (S1, S2) of the U1 device are routed through headers JU13 and JU19 to the on-board digital audio transceiver (U11) and USB stereo audio DAC (U12), respectively (see Tables 24 and 25). Place shunts across all 2-3 positions to connect the U1 device's S1 and S2 interfaces to the listed U11 and U12 interfaces.

## Digital Audio Transceiver (U11)

The digital audio transceiver connects to TOSLINK connectors J5 and J6 for audio input and output. The device is operated in software mode ( $\overline{HS}$  pin tied low) and is connected to the U1 device's S1 digital audio interface. The audio transceiver is also interfaced to the EV kit's SPI control bus and is selected by the  $\overline{CS1}$  chip select line. See the *S/PDIF Audio* section. To manually configure the

device's registers, select the **Show S/PDIF Transceiver Registers** item from the **View** drop-down menu. This enables the **CS8427** tab, which functions in the same manner as the **Control Registers** tab. When the U11 device is enabled, the **Read All** button also reads all the U11 registers and updates the **CS8427** tab.

## USB Stereo Audio DAC (U12)

The USB stereo audio DAC connects to the mini-USB connector J10 for audio input. The audio DAC uses a standard Windows class driver, and when connected to a PC it is recognized as an external sound card, allowing audio from a PC to be played through the EV kit. This audio path is configured and enabled by selecting the **USB** block on the **Digital Audio** tab. See the *USB Audio* section.

**Table 22. JU10 and JU11 Function**

SHUNT POSITION	HEADPHONE MODE
Installed	Single-ended (clickless)
Not installed*	Differential, capacitorless, or single-ended (fast turn-on)

\*Default position.

**Table 23. JU14–JU17 and JU22 Functions**

SHUNT POSITION	DVDD (JU14)	MICVDD (JU22)	PVDD (JU16)	AVDD (JU15)	DVDDIO* (JU17)
Installed**	1.8V	1.8V	1.8V	1.8V	3.3V
Not installed	Connect an external supply across their respective pads and ground.				

\*Connects to DVDDSD1.

\*\*Default position.

**Table 24. S1 Interface Header (JU13)**

JU13		
POSITION 1 (LEFT)	POSITION 2 (CENTER)	POSITION 3 (RIGHT)
GND	DACIN1	U11_DAC
GND	ADCOU1	U11_ADC
GND	LRCLK1	U11_LRCLK
GND	BCLK1	U11_BCLK

**Table 25. S2 Interface Header (JU19)**

JU19		
POSITION 1 (LEFT)	POSITION 2 (CENTER)	POSITION 3* (RIGHT)
GND	DACIN2	U12_DAC
GND	ADCOU2	U12_ADC
GND	LRCLK2	U12_LRCLK
GND	BCLK2	U12_BCLK

\*Signals are routed from the U4 level translator.

# MAX9880A Evaluation Kit

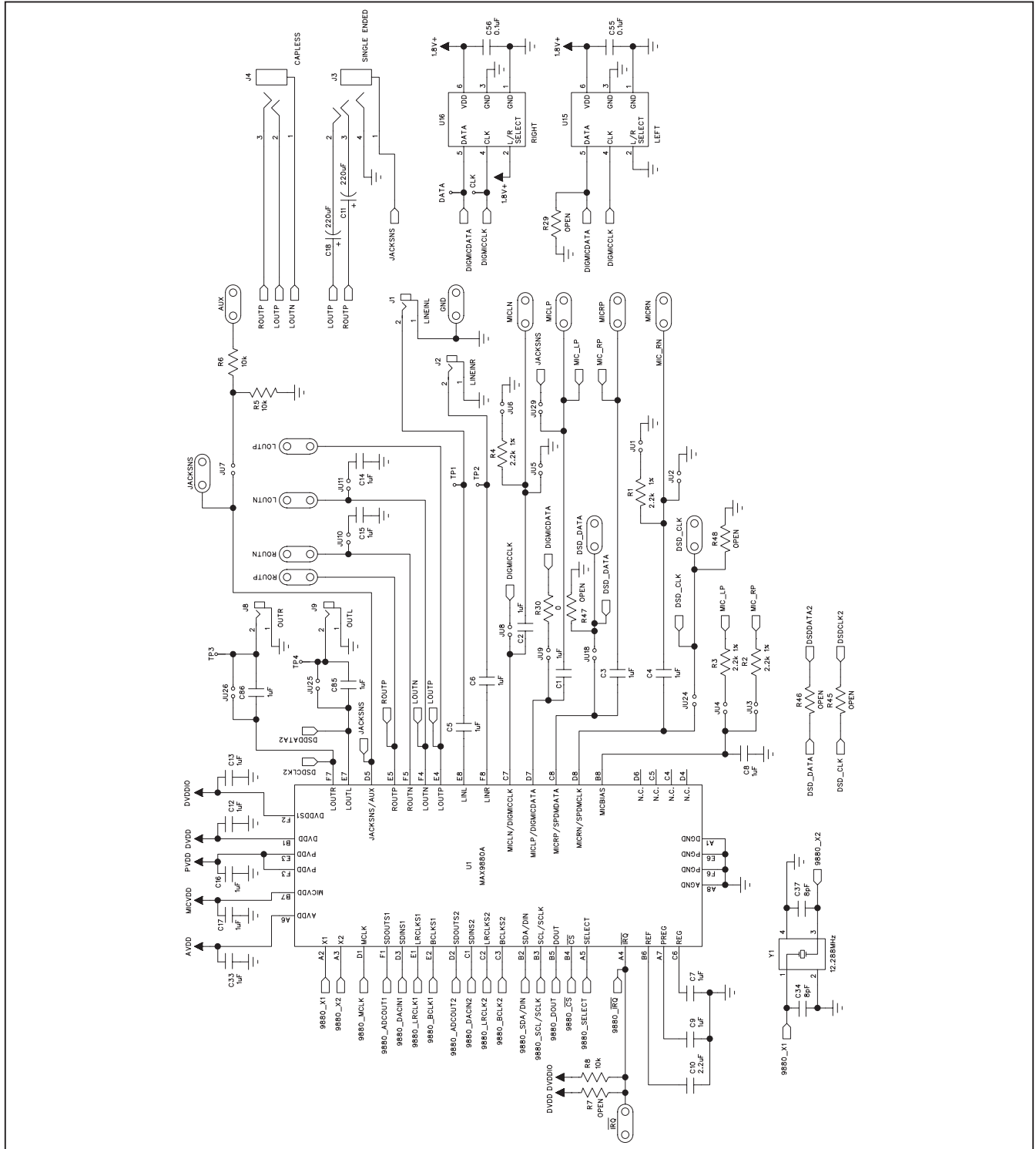

Figure 21a. MAX9880A EV Kit Schematic—MAX9880A Device (Sheet 1 of 7)

# MAX9880A Evaluation Kit

Evaluates: MAX9880A

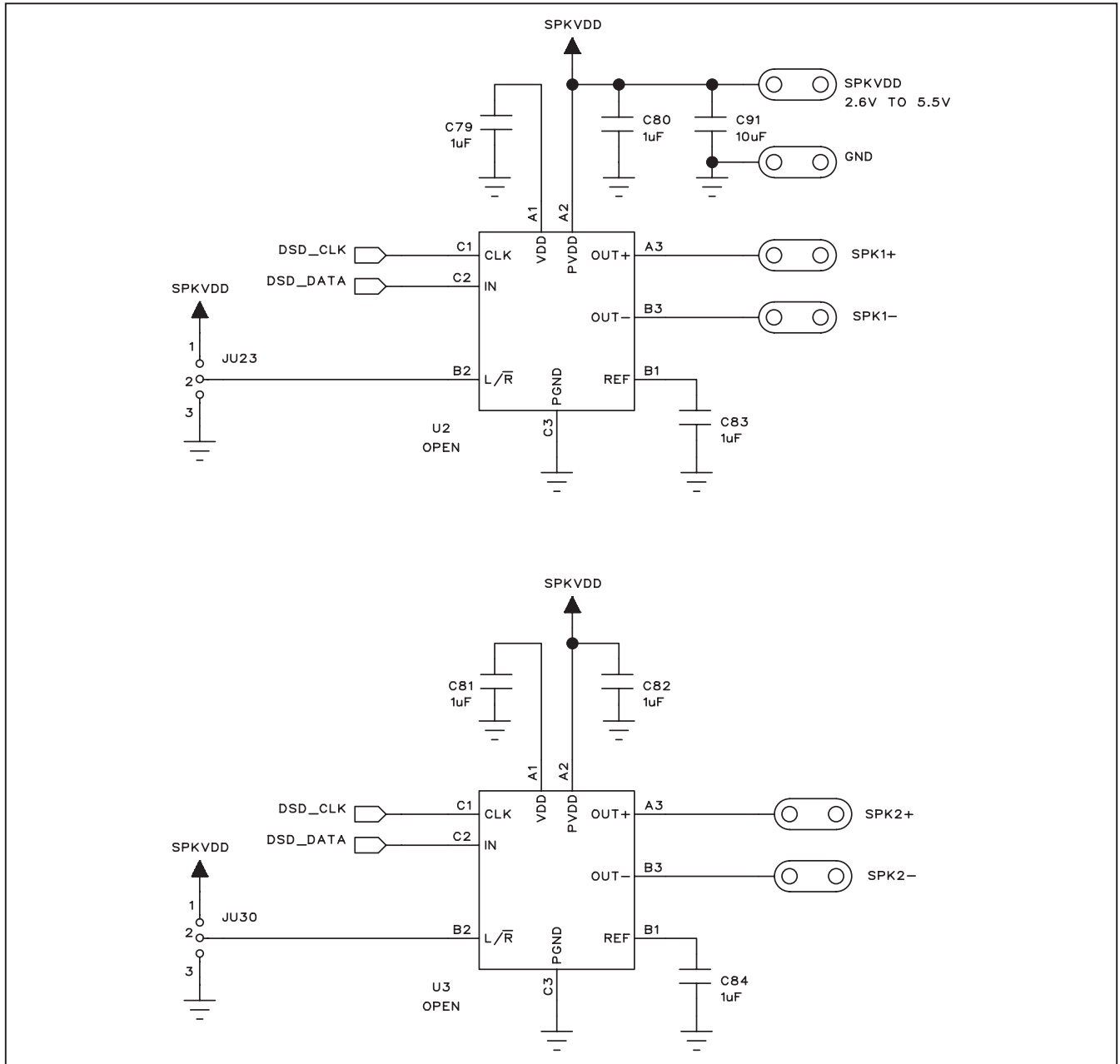

Figure 21b. MAX9880A EV Kit Schematic—Class D Amplifiers (Sheet 2 of 7)



# MAX9880A Evaluation Kit

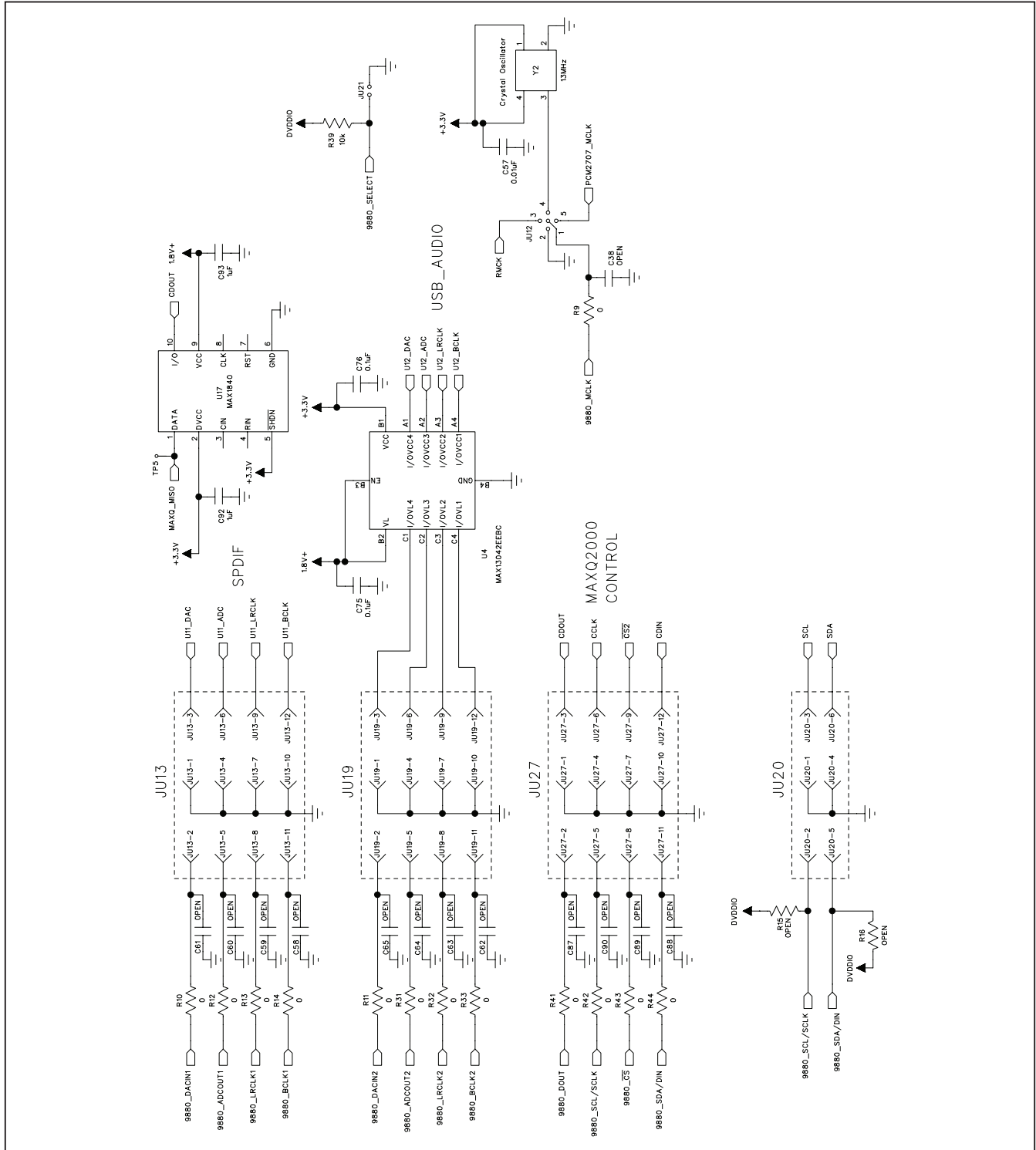

Figure 21c. MAX9880A EV Kit Schematic—SPDIF, USB\_AUDIO, and MAXQ2000 CONTROL Headers, On-Board Crystal Oscillator, and Interface-Mode-Selection Jumper (JU21) (Sheet 3 of 7)

# MAX9880A Evaluation Kit

Evaluates: **MAX9880A**

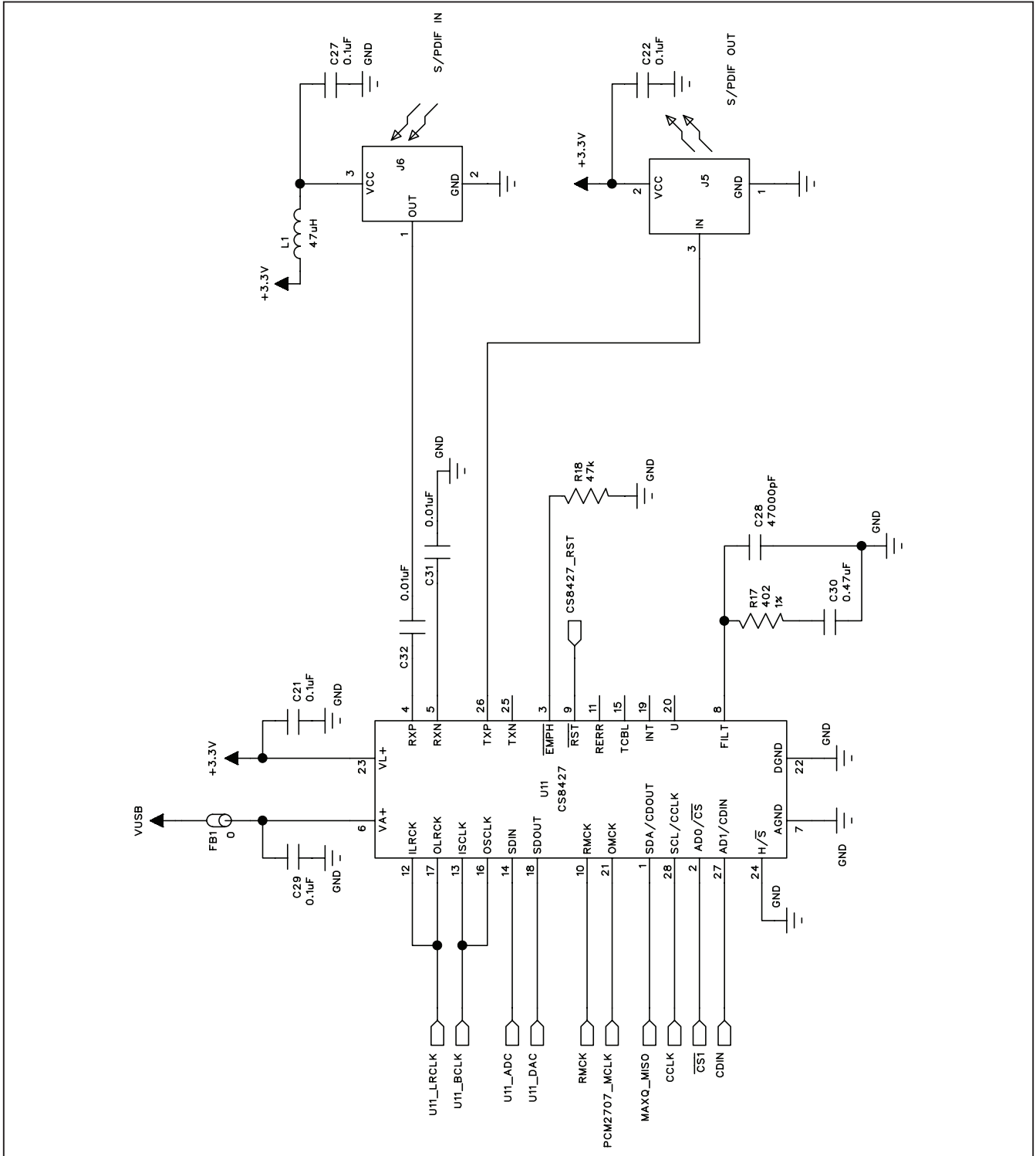

Figure 21d. MAX9880A EV Kit Schematic—CS8427 Digital Audio Transceiver (Sheet 4 of 7)

# MAX9880A Evaluation Kit

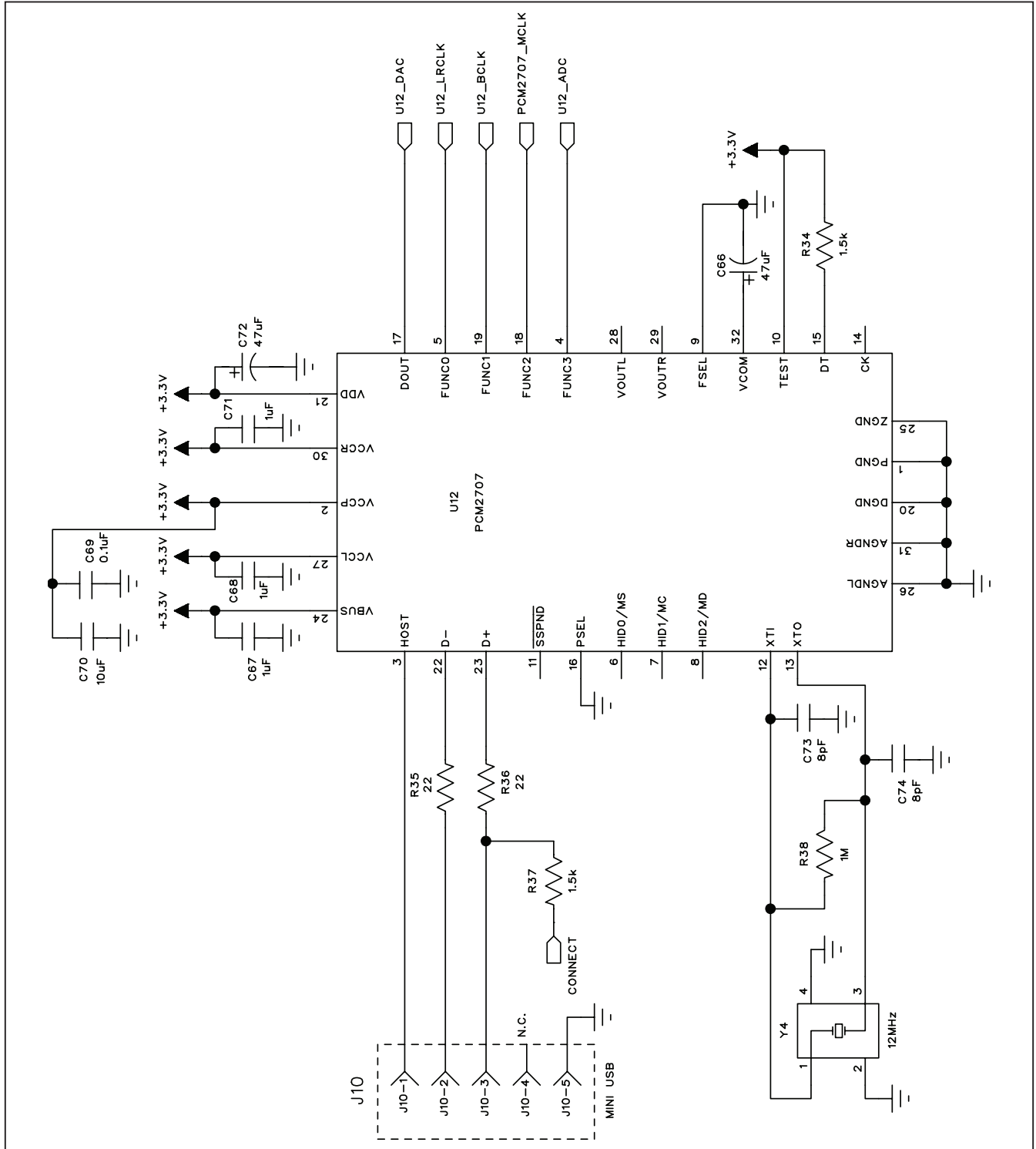

Figure 21e. MAX9880A EV Kit Schematic—PCM2707 USB Stereo Audio DAC (Sheet 5 of 7)

# MAX9880A Evaluation Kit

Evaluates: **MAX9880A**

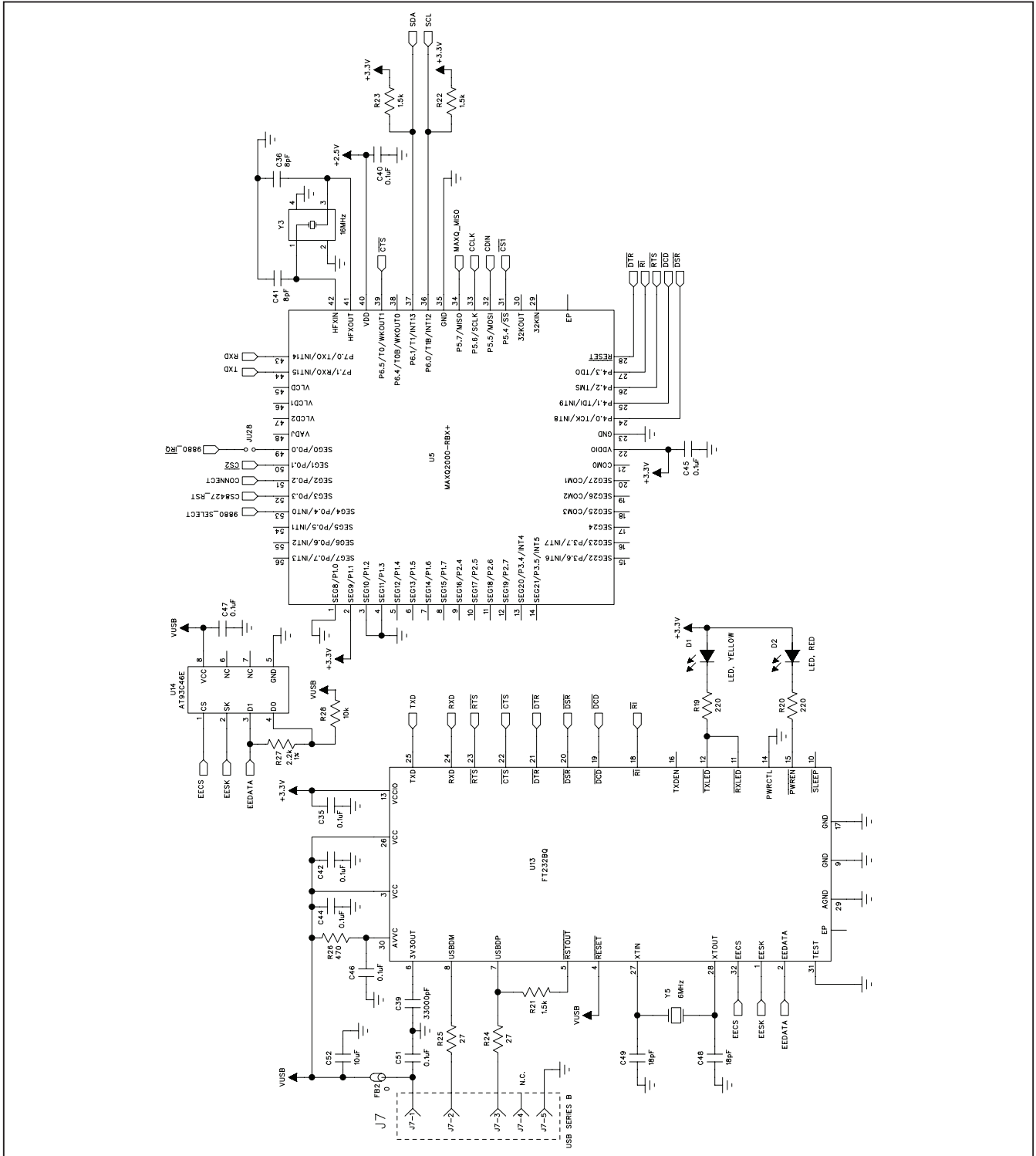

Figure 21f. MAX9880A EV Kit Schematic—MAXQ2000 Interface Circuit (Sheet 6 of 7)

# MAX9880A Evaluation Kit

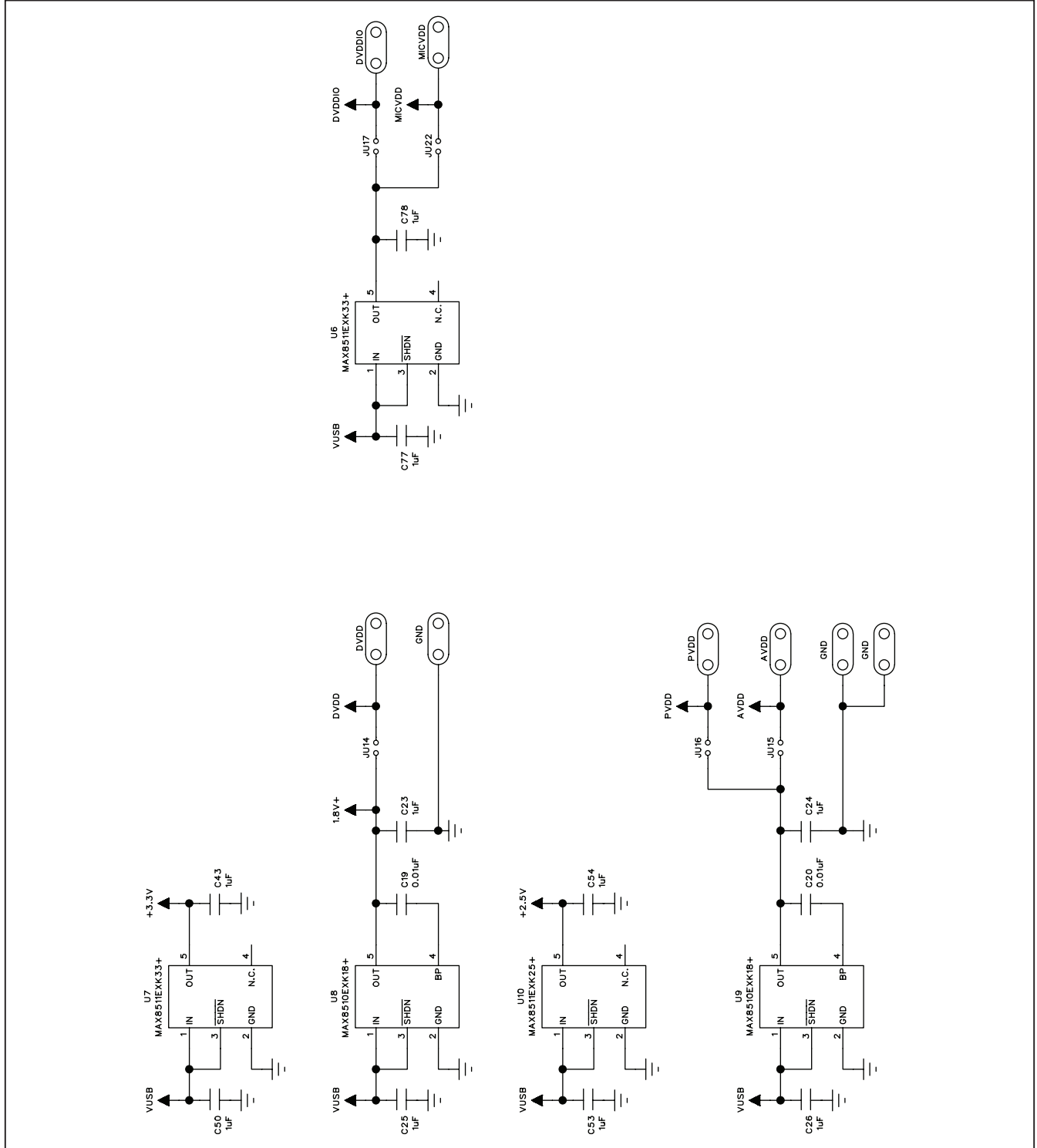

Figure 21g. MAX9880A EV Kit Schematic—On-Board LDOs (Sheet 7 of 7)

# MAX9880A Evaluation Kit

Evaluates: MAX9880A

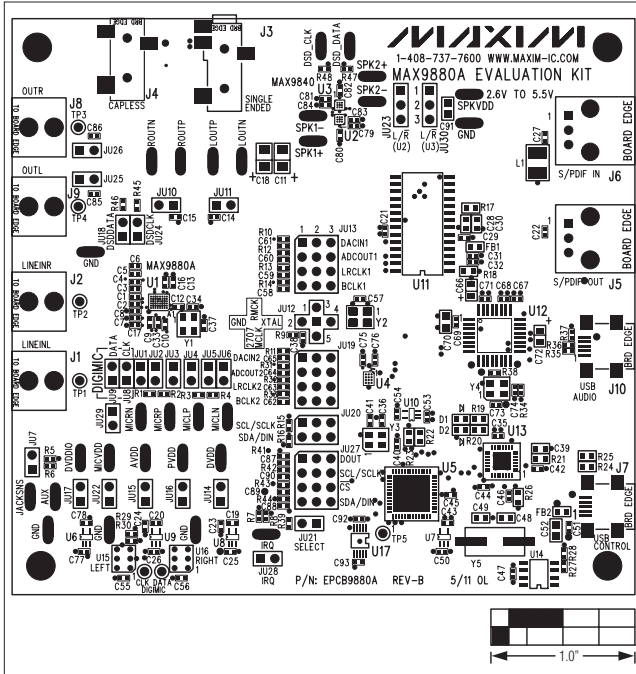

Figure 22. MAX9880A EV Kit Component Placement Guide—Component Side

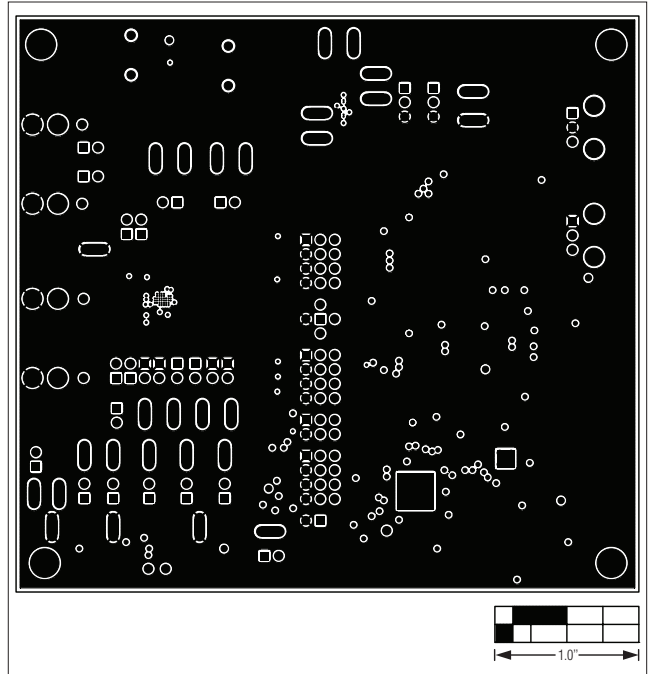

Figure 24. MAX9880A EV Kit PCB Layout—Layer 2

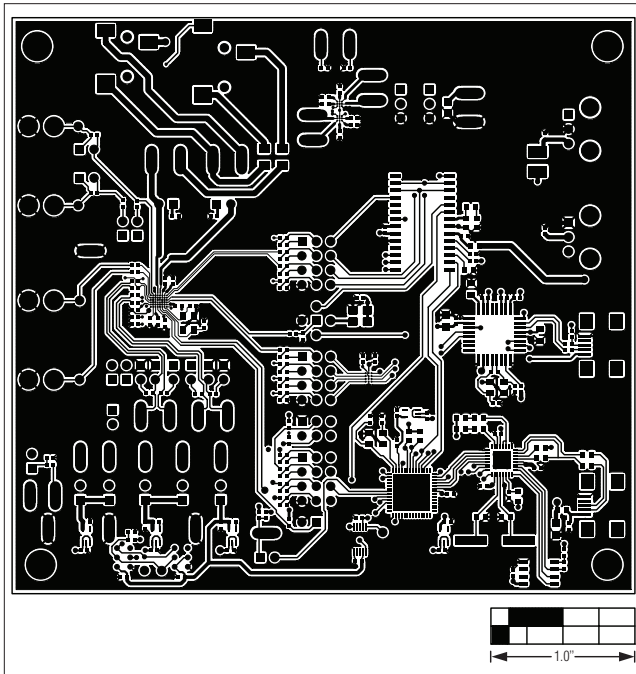

Figure 23. MAX9880A EV Kit PCB Layout—Component Side

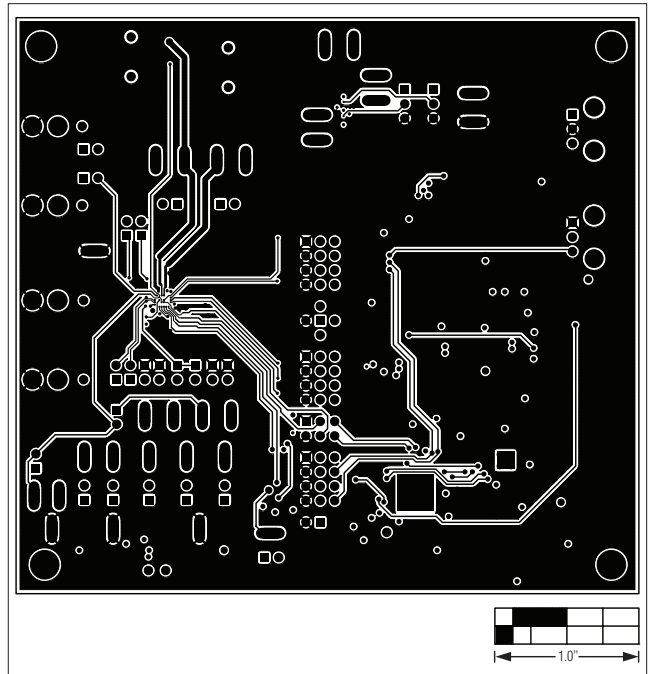

Figure 25. MAX9880A EV Kit PCB Layout—Layer 3

# MAX9880A Evaluation Kit

Evaluates: MAX9880A

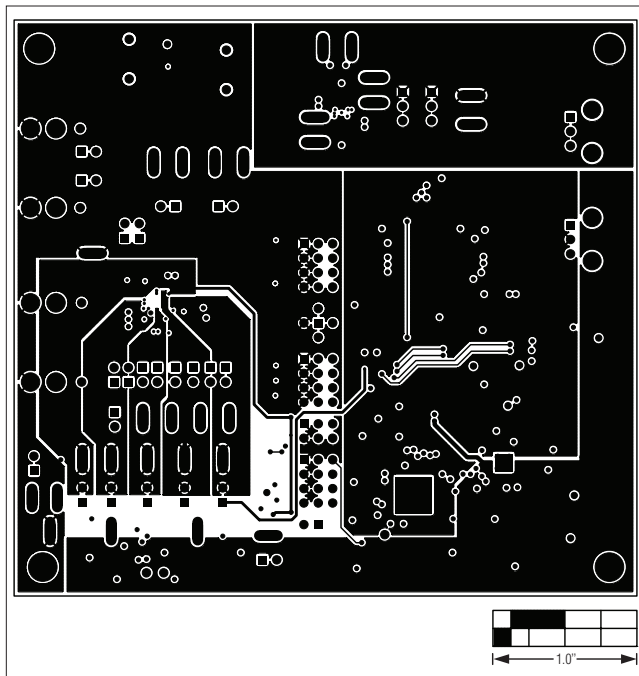

Figure 26. MAX9880A EV Kit PCB Layout—Layer 4

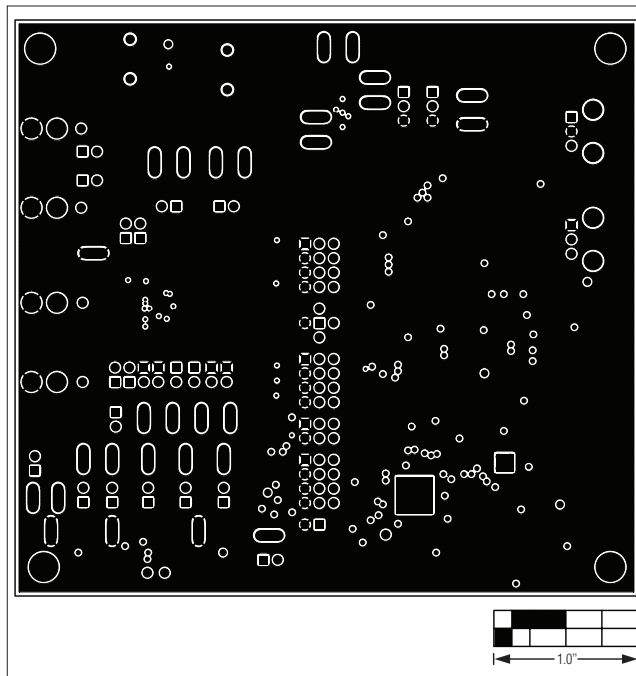

Figure 27. MAX9880A EV Kit PCB Layout—Layer 5

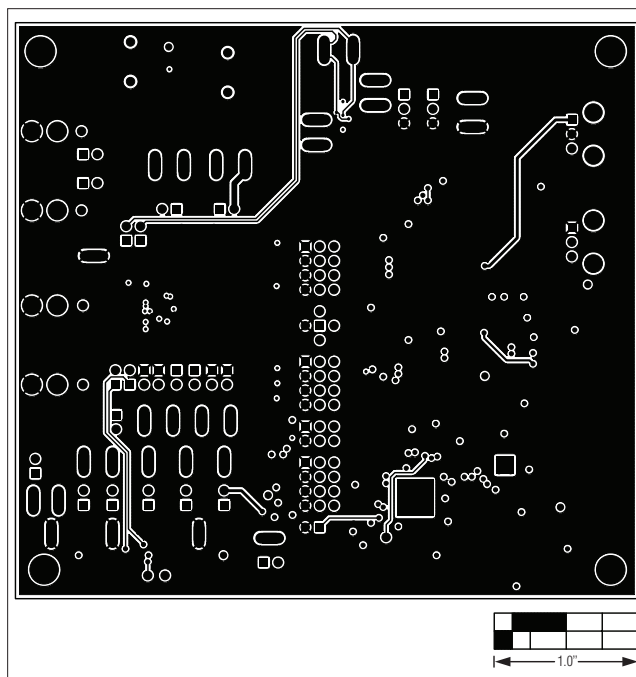

Figure 28. MAX9880A EV Kit PCB Layout—Solder Side



# MAX9880A Evaluation Kit

## Revision History

REVISION NUMBER	REVISION DATE	DESCRIPTION	PAGES CHANGED
0	9/10	Initial release	—
1	5/11	Replaced obsolete components U15 and U16	3, 5, 28, 35

**Evaluates: MAX9880A**

*Maxim cannot assume responsibility for use of any circuitry other than circuitry entirely embodied in a Maxim product. No circuit patent licenses are implied. Maxim reserves the right to change the circuitry and specifications without notice at any time.*

**Maxim Integrated Products, 120 San Gabriel Drive, Sunnyvale, CA 94086 408-737-7600 \_\_\_\_\_ 37**