

10 9 8 7 6 5 4 3 2 1

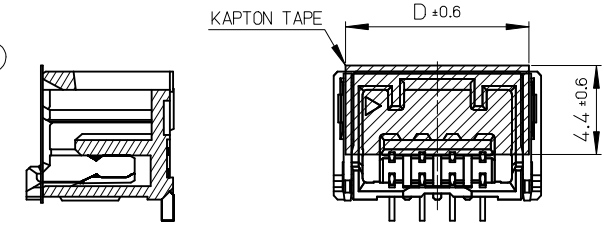

SECTION Z-Z

2~7極カプトンテープ形状
KAPTON TEPE FIGURE OF 2-7 CIRCUIT

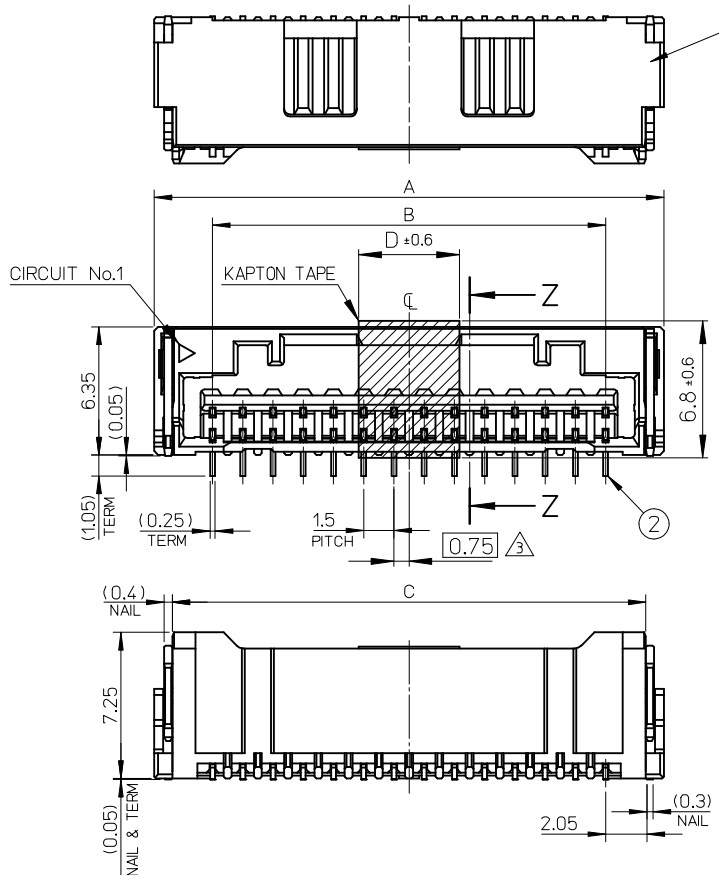
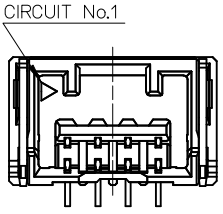
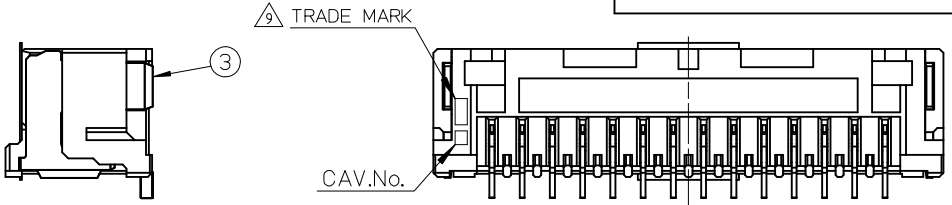
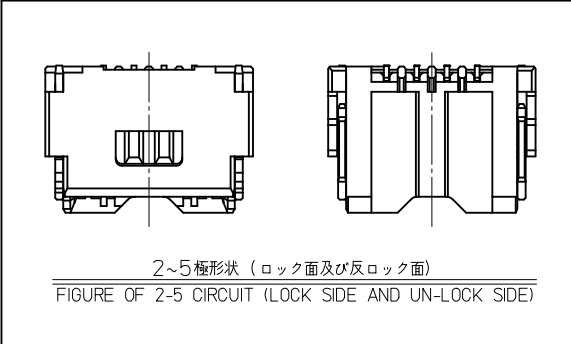

2~5 極の場合
CASE OF 2-5 CIRCUIT

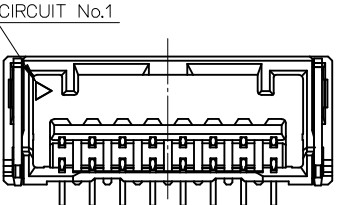

6~11 極の場合
CASE OF 6-11 CIRCUIT

5	25	21	26.8	505405 156*	15
5	23.5	19.5	25.3	146*	14
5	22	18	23.8	136*	13
5	20.5	16.5	22.3	126*	12
5	19	15	20.8	116*	11
5	17.5	13.5	19.3	106*	10
5	16	12	17.8	096*	9
5	14.5	10.5	16.3	086*	8
13.6	13	9	14.8	076*	7
12.1	11.5	7.5	13.3	066*	6
10.6	10	6	11.8	056*	5
9.1	8.5	4.5	10.3	046*	4
7.6	7	3	8.8	036*	3
6.1	5.5	1.5	7.3	505405 026*	2
D	C	B	A	EMBOSSD TAPE PACKAGE 注文番号 ORDER No.	CIRCUIT No.

No.	部品 PART	材料 MATERIAL
①	ハウジング HOUSING	耐熱性樹脂 UL94V-0 HEATPROOF RESIN UL94V-0
②	ターミナル TERMINAL	銅合金 COPPER ALLOY
		CONTACT POS. 金めっき: 0.2 micro-meter MIN. GOLD
		TAIL POS. 錫めっき: 1.0 micro-meter MIN. TIN
③	ネイル NAIL	銅合金 COPPER ALLOY
		錫めっき: 1.0 micro-meter MIN. TIN
		ニッケルめっき(下地): 1.0 micro-meter MIN. NICKEL (UNDER PLATING)

REVISED EC NO: J2017-0292 DRAWN: ISOGAYA CHKD: AIDA APPR: KANEKO	DESCRIPTION 2016/11/29 2016/11/29 2016/12/02	GENERAL TOLERANCES (UNLESS SPECIFIED)		DIMENSION STYLE MM ONLY		SCALE 4:1	DESIGN UNITS METRIC	THIRD ANGLE PROJECTION	
		0.25 UNDER UNDER ±0.03	0.25 OVER 0.5 UNDER ±0.05	DRAWN BY TAKAIKE	DATE 2014/10/17	TITLE CLIK-MATE 1.5MM PITCH W/BCONN ST TYPE REC ASSY WITH KAPTON TAPE			
		0.5 OVER 1.0 UNDER ±0.1	1.0 OVER 30 UNDER ±0.2	CHECKED BY KASAKAWA	DATE 2015/02/16				
		10 OVER 30 UNDER ±0.25	30 OVER ±0.3	APPROVED BY NUKITA	DATE 2015/02/16				
ANGULAR ±1 °				SIZE A3		THIS DRAWING CONTAINS INFORMATION THAT IS PROPRIETARY TO MOLEX ELECTRONIC TECHNOLOGIES, LLC AND SHOULD NOT BE USED WITHOUT WRITTEN PERMISSION			
DRAFT WHERE APPLICABLE MUST REMAIN WITHIN DIMENSIONS									

9 8 7 6 5 4 3 2 1

NOTES

1. 嵌合相手 : 502578
MATE WITH : 502578 SERIES
2. 端子テール部及びネイルの平坦度 : 0.1 MAX.
TAIL AND NAIL COPLANARITY TO BE 0.1 MAX.
3. 極数/2 = 偶数に適用
APPLY FOR CIRCUIT SIZE / 2 = EVEN
4. 端子テール部及びネイルに錫めっきを使用している為、
外觀に摺動痕が付く場合があります。
THE WOUND OF FRICTION MIGHT ADHERE TO EXTERNALS
BECAUSE THE TIN PLATING IS USED FOR THE TAIL AND NAIL.

5. 製品番号
MATERIAL No.

505405 * * 6 *

No.	COLOR	CIRCUIT
60	ベージュ BEIGE	2~15

極数 ↑
CIRCUIT SIZE

色 ↑
COLOR

※本製品はカプトンテープ有り品です。カプトンテープ無し品はSD-505405-001を参照してください。

*THIS PRODUCT HAVE THE KAPTON TAPE.
PLEASE REFER TO SD-505405-001 FOR THE PRODUCT WITHOUT THE KAPON TAPE.

6. 本製品のプラスチック部に黒点・白点等が確認される場合や
色合いが異なる場合がありますが、製品性能に影響はありません。
THERE IS NO INFLUENCE IN THE PRODUCT
PERFORMANCE THOUGH THE BLACK AND WHITE SPOT ETC.
MIGHT BE CONFIRMED TO THE PLASTIC PART OF
THIS PRODUCT AND THE SHADE MIGHT BE DIFFERENT.

7. ELV 及び RoHS 適合品
ELV AND RoHS COMPLIANT

8. ORDER No. AND CONNECTOR SERIES No.

9. トレードマーク : Mプラス 2文字の製造工場を示すアルファベットにて表示。
但し、"J"はJAPANを"L"はMALAYSIAを示す。(例 MXJ 又はMXL)
金型番号 : アルファベット1文字にて表示。(例 1A, 12A, 1B, 12B)
FORMED BY M AND FROM 1 TO 2 MORE LETTER OF ALPHABET
WHICH MEAN THE MANUFACTORY.
BUT "J" MEANS JAPAN. "L" MEANS MALAYSIA (TO TRADE MARK)
(e.g. MXJ OR MXL).
AND BY 1 - 2 DIGIT NUMBER (TO CAVITY NO.)
AND BY 1 LETTER OF ALPHABET (TO MOLD NO.)(e.g. 1A, 12A, 1B, 12B).

10. 適用プラグターミナル : 5025791*00, 5034291*00
APPLICABLE PLUG TERMINAL : 5025791*00, 5034291*00

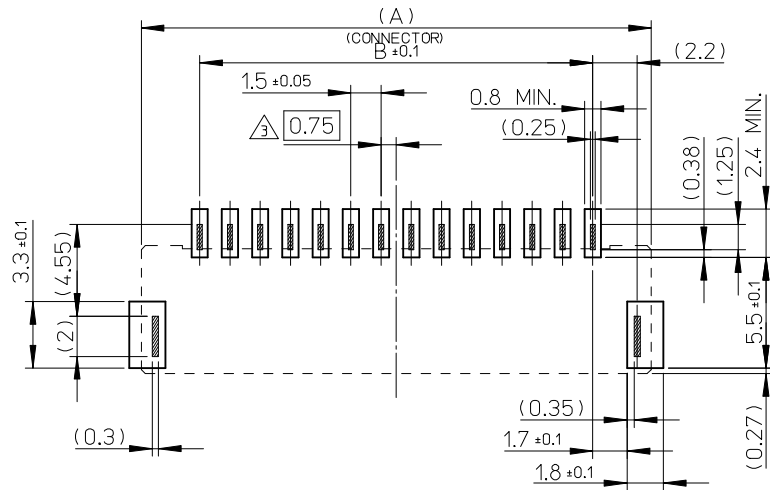

基板パターンレイアウト (参考)
RECOMMENDED P.C.B PATTERN LAYOUT (REF.)

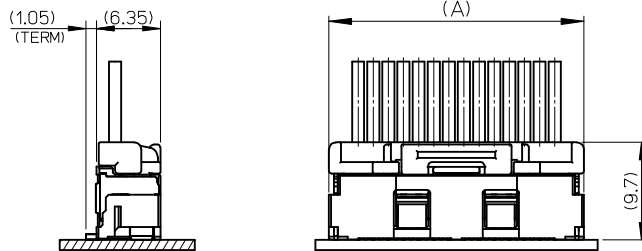

嵌合図
MATED CONNECTORES

GENERAL TOLERANCES (UNLESS SPECIFIED)			DIMENSION STYLE MM ONLY		SCALE 4:1	DESIGN UNITS METRIC	THIRD ANGLE PROJECTION
0.25 UNDER	UNDER	± 0.03	DRAWN BY	DATE	TITLE		
0.25 OVER	0.5 UNDER	± 0.05	TAKAIKE	2014/10/17	CLICK-MATE 1.5MM PITCH W/BCONN ST TYPE REC ASSY WITH KAPTON TAPE		
0.5 OVER	1.0 UNDER	± 0.1	CHECKED BY	DATE			
1.0 OVER	30 UNDER	± 0.2	KASAKAWA	2015/02/16			
10 OVER	30 UNDER	± 0.25	APPROVED BY	DATE	DOCUMENT NO.		
30 OVER		± 0.3	NUKITA	2015/02/16	SD-505405-003		
ANGULAR	±1 °		MATERIAL NO.		SHEET NO.		
DRAFT WHERE APPLICABLE MUST REMAIN WITHIN DIMENSIONS			SEE TABLE		2 OF 3		
			THIS DRAWING CONTAINS INFORMATION THAT IS PROPRIETARY TO MOLEX ELECTRONIC TECHNOLOGIES, LLC AND SHOULD NOT BE USED WITHOUT WRITTEN PERMISSION				

ORDER No. AND CONNECTOR SERIES No.

HSG COLOR : BEIGE		
5054051560	505405**60	15
1460		14
1360		13
1260		12
1160		11
1060		10
0960		9
0860		8
0760		7
0660		6
0560		5
0460		4
0360	3	
5054050260		2
EMBOSSED TAPE PACKAGE	コネクタシリーズ	極数
オーダー番号ORDER No.	CONNECTOR SERIES	(KT. NO.)

REVISED EC NO: J2017-0292 DRWN: MISOGAYA 2016/11/29 CHK: AIDA 2016/11/29 APPR: KANEKO 2016/12/02	GENERAL TOLERANCES (UNLESS SPECIFIED)			DIMENSION STYLE MM ONLY		SCALE 4:1	DESIGN UNITS METRIC	THIRD ANGLE PROJECTION
	0.25 UNDER	UNDER	± 0.03	DRAWN BY	DATE	TITLE CLIK-MATE 1.5MM PITCH W/BCONN ST TYPE REC ASSY WITH KAPTON TAPE		
	0.25 OVER	0.5 UNDER	± 0.05	TAKAIKE	2014/10/17			
	0.5 OVER	1.0 UNDER	± 0.1	CHECKED BY	DATE			
	1.0 OVER	10 UNDER	± 0.2	KASAKAWA	2015/02/16			
	10 OVER	30 UNDER	± 0.25	APPROVED BY	DATE	DOCUMENT NO. SD-505405-003 SHEET NO. 3 OF 3		
30 OVER		± 0.3	NUKITA	2015/02/16				
ANGULAR	±1 °		MATERIAL NO.		SEE TABLE			
DRAFT WHERE APPLICABLE MUST REMAIN WITHIN DIMENSIONS			SIZE A3	THIS DRAWING CONTAINS INFORMATION THAT IS PROPRIETARY TO MOLEX ELECTRONIC TECHNOLOGIES, LLC AND SHOULD NOT BE USED WITHOUT WRITTEN PERMISSION				