

**True RMS 300A AC Mini Clamp Meter with Non-Contact Voltage Detector**

**Model MA140**

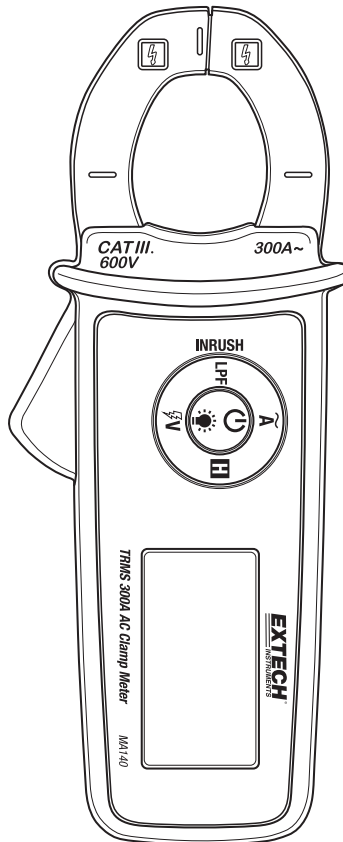

## Introduction

---

Thank you for selecting the Extech MA140 300A AC True RMS Mini Clamp Meter with Non-Contact Voltage Detector. The MA140 is small in size but rugged in performance.

The MA140 measures AC current to 300A and offers a Smart Data Hold feature, display Backlight, In-rush Current mode, Low Pass Filtering (LPF), and a non-contact Volt-Detection feature that senses electrical sources safely.

This device is shipped fully tested and calibrated and, with proper use, will provide years of reliable service. Please visit our website ([www.extech.com](http://www.extech.com)) to check for the latest version of this User Guide, Product Updates, Product Registration, and Customer Support.

## **Safety Information – Please Read First**

---

To ensure the safe operation and service of the meter, follow these instructions closely. Failure to observe warnings can result in severe injury.

### **WARNINGS**











WARNINGS identify hazardous conditions and actions that could cause BODILY HARM or DEATH.

- Individual protective equipment should be used if HAZARDOUS LIVE parts in the installation where measurements are to be carried out could be accessible.
- If the equipment is used in a manner not specified by the manufacturer, the protection provided by the equipment may be impaired.
- To reduce the risk of fire or electric shock, do not expose this product to rain or moisture.
- Verify the meter operation by measuring a known voltage. If in doubt, have the meter serviced.
- Do not apply more than the rated voltage as marked on the meter.
- To avoid false readings that can lead to electric shock and injury, replace battery as soon as the low battery indicator appears.
- Do not use the meter in or around explosive gas or vapor.
- Please keep fingers and hands behind the finger guards.
- Do not expose meter to extremes in temperature or high humidity.
- De-energize the installation under test or wear suitable protective clothing when placing or removing the current clamp from a test setup.
- Do not apply/remove the current clamp to/from UNINSULATED HAZARDOUS LIVE conductors which may cause electric shock, electric burn, or arc flash.

## CAUTIONS

CAUTIONS identify conditions and actions that could cause DAMAGE to the meter or equipment under test. Do not expose the meter to extremes in temperature or high humidity.

### Safety Symbols that are typically marked on meters and instructions

	This symbol, adjacent to another symbol, indicates the user must refer to the manual for further information.
	Risk of electrical shock
	Do not apply or remove clamp from HAZARDOUS LIVE conductors
	Equipment protected by double or reinforced insulation
	Battery symbol
	Conforms to EU directives
	Do not discard this product in household trash.
	AC measurement
	DC measurement
	Earth ground

### PER IEC1010 OVERVOLTAGE INSTALLATION CATEGORY

#### *OVERVOLTAGE CATEGORY I*

Equipment of OVERVOLTAGE CATEGORY I is equipment for connection to circuits in which measures are taken to limit the transient over-voltages to an appropriate low level.

Note – Examples include protected electronic circuits.

#### *OVERVOLTAGE CATEGORY II*

Equipment of OVERVOLTAGE CATEGORY II is energy-consuming equipment to be supplied from the fixed installation.

Note – Examples include household, office, and laboratory appliances.

#### *OVERVOLTAGE CATEGORY III*

Equipment of OVERVOLTAGE CATEGORY III is equipment in fixed installations.

Note – Examples include switches in the fixed installation and some equipment for industrial use with permanent connection to the fixed installation.

#### *OVERVOLTAGE CATEGORY IV*

Equipment of OVERVOLTAGE CATEGORY IV is for use at the origin of the installation.

Note – Examples include electricity meters and primary over-current protection equipment

# Description

## Meter Description

1. Transformer current jaw
2. Finger-Hand Guard
3. Jaw opening trigger
4. LCD Multi-function display
5. Push-button controls

Note that the battery compartment is located on back of meter

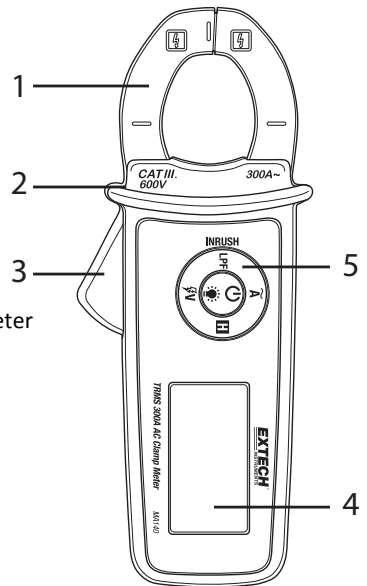

## Display Description

1. Non-Contact Volt Detect icon
2. Main Display digits
3. In-Rush Current mode
4. Low Pass Filter
5. Data Hold
6. AC Measurement
7. Amperes (current)
8. Battery status icon
9. Minus (negative) sign

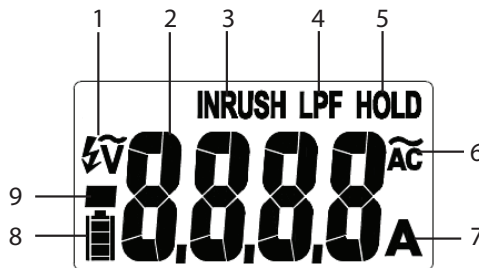

## Control Button Description

- |               |   |
|---------------|---|
| <b>INRUSH</b> | Press for > 2 seconds to access In-rush Current mode                  |
| <b>LPF</b>    | Press to access Low Pass Filter mode                                  |
| <b>~ A</b>    | Press to access current measurement mode                              |
| <b>⚡ V</b>    | Press to access Voltage detect mode                                   |
| <b>H</b>      | Press to switch Data Hold on or off                                   |
| <b>⏻</b>      | Press to power ON the meter. Press and hold > 2 seconds to switch OFF |
| <b>💡</b>      | Press to toggle display backlight on and off                          |

# Operation



## CAUTIONS

Read and understand all of the Safety statements listed in the safety section of this manual prior to use.

## Powering the Meter

1. Press the Power-Backlight button to power the meter. Check the batteries if the unit fails to power ON.
2. Press and hold the Power button for more than 2 seconds to power OFF the meter.
3. The meter has an Auto Power OFF feature (APO) where the meter switches OFF after 20 minutes of inactivity. To disable APO, refer to the next section.

**Note:** The meter displays the battery capacity when powering up.

## Disable Auto Power OFF

The meter will auto power OFF after 20 minutes of inactivity. To defeat this feature, follow the steps below.

1. With the meter OFF, press and hold the 'V' button and, while continuing to hold the 'V' button, press the power button.
2. The display will show **AOFF**.
3. Release all of the buttons.
4. The Auto Power OFF function will now be disabled until the next cycle of power.

## Display Backlight

With the meter powered ON, press the backlight button to switch the backlight ON or OFF. Note that excessive use of the backlight will shorten the battery life.

## AC Current Measurements



**WARNING:** Do not handle the meter above the finger/hand guard barrier.



**CAUTION:** Observe CAT III 600V with respect to Earth Ground for the Jaw.

1. Press the 'A' button to access the AC Current measurement mode. The **A** symbol will appear on the display in the lower right hand side indicating Amperes (Amps).
2. Press the jaw trigger to open the clamp jaw.
3. Position the clamp around only one conductor. See accompanying diagrams for correct and incorrect use.
4. Read the current in the display. The display will indicate the proper decimal point and value.

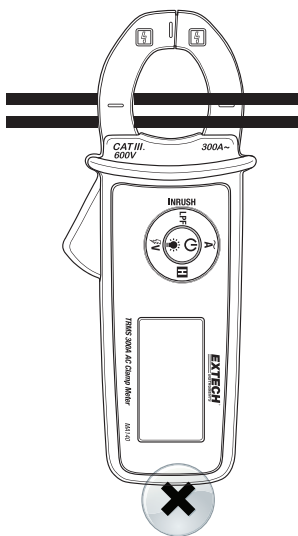
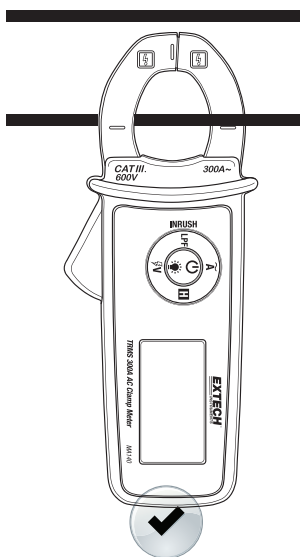

## Inrush Current Mode

In the Inrush mode the meter waits until at least 5A is detected and then starts a 100ms sample window in which to capture an inrush current RMS value. Refer to illustration below.

1. Press and hold the INRUSH button for > 2 seconds to access the Inrush Current mode.
2. The display will show the **INRUSH** icon.
3. When ready, take a current measurement. The meter will capture the highest reading detected during a 100ms window. Note that the 100ms window does not open until at least 5A is detected.
4. To exit the Inrush Current mode press the INRUSH button again momentarily. The **INRUSH** icon will switch OFF.

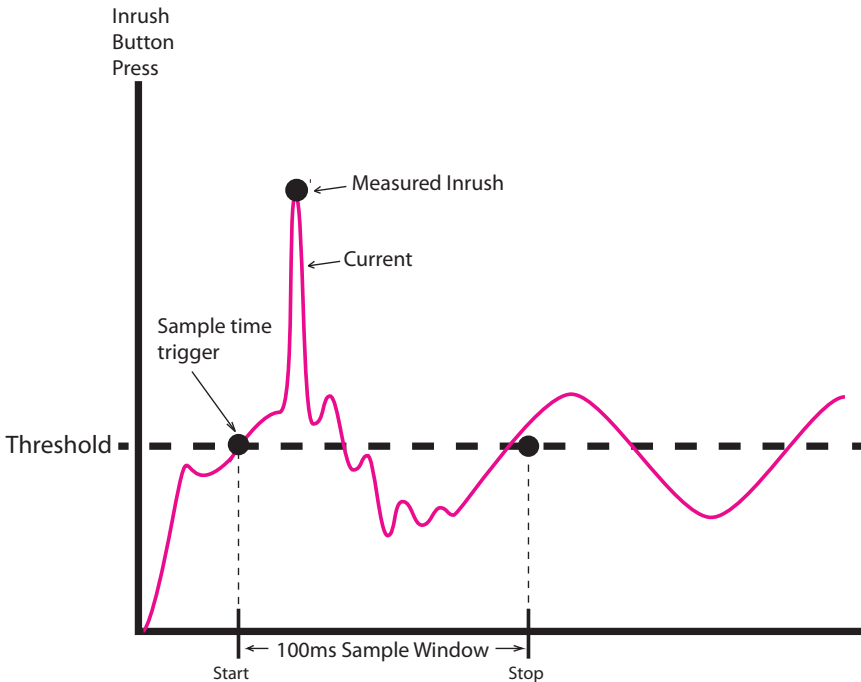

## Low Pass Filter

The Low Pass Filter mode offers high frequency rejection when measuring Variable Speed Drives. The Low Pass Filter mode offers a cut-off frequency of 160Hz (approx.) with an attenuation characteristic of -24db per octave (approx.).

1. Momentarily press the LPF button to access the LPF mode
2. The **LPF** display icon is shown on the display in the LPF mode
3. Press the LPF button again to exit the LPF mode, the **LPF** icon will switch OFF

## Volt-Detection Feature

The meter's audible beeper triggers and the display shows dashes when the meter senses an electrical voltage field. The higher the electrical field strength the greater the number of dashes displayed and the faster the rate of the audible beeps.

If the meter does not emit a tone or display dashes in this mode, there is still the possibility that voltage is present. Please use caution.

1. Press the 'V' button to access the Non-Contact Voltage Detect mode.
2. Note the voltage detection display icons as shown in the Description section of this guide.
3. Place the meter near a source of electrical energy. The tip of the clamp offers the highest sensitivity.
4. Note the audible beeping and the dash displays.

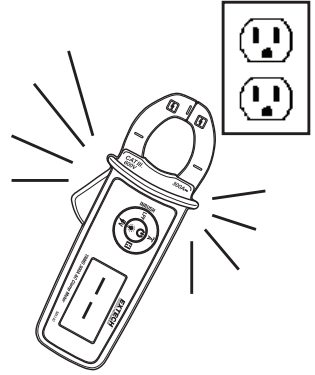

## Smart Data Hold

To freeze the LCD meter reading, press the HOLD button. While data hold is active, the **HOLD** display icon appears on the LCD. Press the HOLD button to return to normal operation. The **HOLD** icon will switch OFF.

The meter's beeper will sound and the display will flash continuously if the detected signal is 50 counts greater than the held reading.



## Maintenance



**WARNING:** To avoid electrical shock, disconnect the meter from any circuit and turn OFF the meter before opening the case. Do not operate with an open case.

### Cleaning and Storage

Periodically wipe the case with a damp cloth and mild detergent; do not use abrasives or solvents. If the meter is not to be used for 60 days or more, remove the batteries and store them separately.

### Battery Replacement

1. Remove the Phillips head screw at the lower back of the meter.
2. Open the battery compartment.
3. Replace the two LR44 batteries observing correct polarity.
4. Re-assemble the meter before use.
5. Safety: Please dispose of batteries responsibly; never dispose of batteries in a fire, batteries may explode or leak; never mix battery types, install new batteries of the same type.



Never dispose of used batteries or rechargeable batteries in household waste. As consumers, users are legally required to take used batteries to appropriate collection sites, the retail store where the batteries were purchased, or wherever batteries are sold.

**Disposal:** Do not dispose of this instrument in household waste. The user is obligated to take end-of-life devices to a designated collection point for the disposal of electrical and electronic equipment.

# Specifications

## ELECTRICAL SPECIFICATIONS

Function	Range	Resolution	Accuracy (of reading) 50/60Hz
AC Current	60.00 A	0.01	± (2.0% + 5 digits)
	300.0 A	0.1	
	All specifications are valid from 10% to 100% of each range The LCD displays 0 counts when the reading < 10 counts		
Low Pass Filter (LPF)	60.00 A	0.01	± (3.5% + 5 digits)
	300.0 A	0.1	
	All specifications are valid from 10% to 100% of each range The LCD displays 0 counts when the reading < 10 counts Cut-off frequency (-3dB): 160Hz Attenuation characteristic: -24db per octave (approximately)		
Function	Range	Resolution	Accuracy (of reading)
Inrush Current	300.0 A	0.1	± (3.5% + 5 digits)
	Integration time: 100ms Trigger current (threshold): 5A		
Volt-Detection	80V~600VAC	n/a	n/a
	The tip of the clamp offers the optimum sensitivity		

### Notes:

- *Clamp position error: ±2% of reading. Maximum ±4% near clamp jaw opening.*
- *Adjacent Conduction Influence of Jaw: <0.08A/A*
- *Accuracy is given as ± (% of reading + least significant digit) at 23°C ±3°C with relative humidity lower than 80%. Accuracy is specified for a period of one year after calibration.*
- *ACA specifications are for AC Coupled, True RMS. For non-sinusoidal waveforms, additional accuracy Crest Factor (C.F.) considerations exist as detailed below:*
  - Add 3.0% for C.F. 1.0~2.0*
  - Add 5.0% for C.F. 2.0~2.5*
  - Add 7.0% for C.F. 2.5~3.0*

## GENERAL SPECIFICATIONS

<b>Display</b>	6000-count Multi-Function LCD
<b>Over-range indication</b>	“OL” or “-OL” is displayed
<b>Conversion rate</b>	2 updates per second
<b>Maximum conductor size</b>	22mm (0.87”) in diameter
<b>Low battery indication</b>	 is displayed. Meter also displays available battery power at startup
<b>Auto Power OFF</b>	After 20 minutes (can be disabled)
<b>Operating Temperature and Humidity</b>	
	0~30°C (32~86°F); 80%RH maximum
	30~40°C (86~104°F); 75%RH maximum
	40~50°C (104~122°F); 45%RH maximum
<b>Storage Temperature and Humidity</b>	
	-20°~60°C (-4°~140°F); 80%RH maximum
<b>Temperature Coefficient</b>	0.2 x specified accuracy / °C, < 20°C (68°F), > 26°C (79°F)
<b>Operating Altitude</b>	2000m (6562ft.)
<b>Battery power</b>	(2) LR-44 1.5V batteries (battery life 50 hours typical)
<b>Weight</b>	140g (4.9 oz.)
<b>Dimensions</b>	60 x 147 x 31.5mm (2.4 x 5.8 x 1.2”)
<b>Safety Standards</b>	For indoor use and in accordance with the requirements for double insulation to EN61010-1, EN61010-2-030, EN61010-2-032, EN61326-1; EN61010-1 Over-voltage CAT III 600V, Pollution Degree 2
<b>Shock and Vibration</b>	Sinusoidal vibration MIL-PRF-28800F for a Class II instrument
<b>Drop Protection</b>	1.2m (4') drop onto hardwood or concrete flooring

**Copyright © 2015 FLIR Systems, Inc.**

All rights reserved including the right of reproduction in whole or in part in any form

**[www.extech.com](http://www.extech.com)**