

**HLMP-ELxx**

**HLMP-EHxx**

**HLMP-EDxx**

Precision Optical Performance AlInGaP II LED Lamps



## Data Sheet

### Description

Precision Optical Performance AlInGaP II (aluminum indium gallium phosphide) LEDs offer superior light output for excellent readability in sunlight and dependable performance. The AlInGaP II technology provides extremely stable light output over long periods of time.

These LED lamps are untinted, nondiffused, T-1<sup>3/4</sup> packages incorporating second generation optics which produce well defined radiation patterns at specific viewing cone angles.

These lamps are made with an advanced optical grade epoxy offering superior high temperature and high moisture resistance performance in outdoor signal and sign applications. The maximum LED junction temperature limit of +130° C enables high temperature operation in bright sunlight conditions. The epoxy contains both uv-a and uv-b inhibitors to reduce the effects of long term exposure to direct sunlight.

### Features

- Well defined spatial radiation patterns
- Viewing angles: 15°, 23°, 30°
- High luminous output
- Colors:
  - 592 nm Amber
  - 617 nm Reddish-Orange
  - 630 nm Red
- High operating temperature:  
T<sub>JLED</sub> = +130°C
- Superior resistance to moisture

### Benefits

- Viewing angles match traffic management requirements
- Colors meet automotive and traffic signal specifications
- Superior light output performance in outdoor environments
- Suitable for autoinsertion into PC boards

### Applications

- Traffic management:
  - Traffic signals
  - Work zone warning lights
  - Variable message signs
- Commercial outdoor advertising:
  - Signs
  - Marquees
- Automotive:
  - Exterior and interior lights

T-1<sup>3</sup>/<sub>4</sub> (5 mm) Precision Optical Performance AlInGaP II LED Lamps  
Selection Guide

Typical Viewing Angle $2\theta^{1/2}$ (Deg.) <sup>[2]</sup>	Color and Dominant Wavelength (nm), Typ. <sup>[1]</sup>	Lamps Without Standoffs (Outline Drawing A)	Lamps With Standoffs (Outline Drawing B)	Luminous Intensity $I_v$ (mcd) <sup>[3,4,5]</sup> @ $I(f) = 20$ mA		
				Min.	Max.	
15°	Amber 592	HLMP-EL16-TW000	HLMP-EL18-TW000	2500	7200	
		HLMP-EL16-TWR00	HLMP-EL18-TWR00	2500	7200	
		HLMP-EL16-TWK00*		2500	7200	
		HLMP-EL16-TWS00		2500	7200	
		HLMP-EL16-TUS00		2500	4200	
		HLMP-EL16-TV400**		2500	5500	
		HLMP-EL16-TVU00		2500	5500	
		HLMP-EL16-UX000	HLMP-EL18-UX000	3200	9300	
		HLMP-EL16-UXR00	HLMP-EL18-UXR00	3200	9300	
		HLMP-EL16-VW000		4200	7200	
		HLMP-EL16-VWR000		4200	7200	
		HLMP-EL16-VWK00*		4200	7200	
		HLMP-EL16-VWS00		4200	7200	
		HLMP-EL16-VX000		4200	9300	
		HLMP-EL16-VXR00		4200	9300	
		HLMP-EL16-VX400**		4200	9300	
		HLMP-EL16-VXK00*		4200	9300	
		HLMP-EL16-VXS00		4200	9300	
		HLMP-EL16-VY000	HLMP-EL18-VY000	4200	12000	
		HLMP-EL16-VYR00	HLMP-EL18-VYR00	4200	12000	
	HLMP-EL16-VYK00*		4200	12000		
	HLMP-EL16-VYS00		4200	12000		
	Red-Orange 615			HLMP-EH18-TW000	2500	7200
			HLMP-EH16-UX000	HLMP-EH18-UX000	3200	9300
	Red 630		HLMP-ED16-TW000	HLMP-ED18-TW000	2500	7200
			HLMP-ED16-TWT00	HLMP-ED18-TWT00	2500	7200
			HLMP-ED16-UX000	HLMP-ED18-UX000	3200	9300
			HLMP-ED16-UXT00	HLMP-ED18-UXT00	3200	9300

T-1<sup>3</sup>/<sub>4</sub> (5 mm) Precision Optical Performance AllnGaP II Led Lamps (Continued)  
Selection Guide

Typical Viewing Angle 2 $\theta$ <sup>1</sup> / <sub>2</sub> (Deg.) <sup>[2]</sup>	Color and Dominant Wavelength (nm), Typ. <sup>[1]</sup>	Lamps Without Standoffs (Outline Drawing A)	Lamps With Standoffs (Outline Drawing B)	Luminous Intensity I <sub>v</sub> (mcd) <sup>[3,4]</sup> @ I(f) = 20 mA	
				Min.	Max.
23°	Amber 592	HLMP-EL25-QS400**		1150	2500
		HLMP-EL25-QSU00		1150	2500
		HLMP-EL25-QSK00*		1150	2500
		HLMP-EL25-QSS00		1150	2500
		HLMP-EL25-QT000		1150	3200
		HLMP-EL25-QTR00	HLMP-EL27-QTR00	1150	3200
		HLMP-EL25-RU000	HLMP-EL27-RU000	1500	4200
		HLMP-EL25-RUR00	HLMP-EL27-RUR00	1500	4200
		HLMP-EL25-RUK00*		1500	4200
		HLMP-EL25-RUS00		1500	4200
		HLMP-EL25-ST000		1900	3200
		HLMP-EL25-STR00		1900	3200
		HLMP-EL25-STK00*		1900	3200
		HLMP-EL25-STS00		1900	3200
		HLMP-EL25-SU000		1900	4200
		HLMP-EL25-SUR00		1900	4200
		HLMP-EL25-SU400**		1900	4200
		HLMP-EL25-SUU00		1900	4200
		HLMP-EL25-SUK00*		1900	4200
		HLMP-EL25-SUS00		1900	4200
		HLMP-EL25-SVK00*		1900	5500
		HLMP-EL25-SVS00		1900	5500
		HLMP-EL25-SV000	HLMP-EL27-SV000	1900	5500
		HLMP-EL25-SVR00	HLMP-EL27-SVR00	1900	5500
		HLMP-EL25-TW000	HLMP-EL27-TW000	2500	7200
		HLMP-EL25-TWR00	HLMP-EL27-TWR00	2500	7200
HLMP-EL25-TWK00*		2500	7200		
HLMP-EL25-TWS00		2500	7200		

Notes:

1. Dominant Wavelength,  $\lambda_d$ , is derived from the CIE Chromaticity Diagram and represents the color of the lamp.
2.  $\theta_{1/2}$  is the off-axis angle where the luminous intensity is one half the on-axis intensity.
3. The luminous intensity is measured on the mechanical axis of the lamp package.

4. The optical axis is closely aligned with the package mechanical axis.
5. Tolerance for each intensity bin limit is  $\pm 15\%$ .

Part numbers in **bold** are recommended for new designs.

\*HLMP-xLxx-xxK00 are selected to amber color bins 2 and 4 only.

\*\*HLMP-xLxx-xx400 are selected to amber color bin 4 only.

T-1<sup>3</sup>/<sub>4</sub> (5 mm) Precision Optical Performance AllnGaP II Led Lamps (Continued)  
Selection Guide

Typical Viewing Angle $2\theta^{1/2}$ (Deg.) <sup>[2]</sup>	Color and Dominant Wavelength (nm), Typ. <sup>[1]</sup>	Lamps Without Standoffs (Outline Drawing A)	Lamps With Standoffs (Outline Drawing B)	Luminous Intensity I <sub>v</sub> (mcd) <sup>[3,4]</sup> @ I(f) = 20 mA		
				Min.	Max.	
23°	Red-Orange 615	HLMP-EH25-QT000		1150	3200	
		HLMP-EH25-RU000		1500	4200	
			HLMP-EH27-SV000	1900	5500	
		HLMP-EH25-TW000	HLMP-EH27-TW000	2500	7200	
	Red 630	HLMP-ED25-QT000		1150	3200	
		HLMP-ED25-QTT00		1150	3200	
		HLMP-ED25-RU000	HLMP-ED27-RU000	1500	4200	
		HLMP-ED25-RUT00	HLMP-ED27-RUT00	1500	4200	
		HLMP-ED25-SV000	HLMP-ED27-SV000	1900	5500	
		HLMP-ED25-SVT00	HLMP-ED27-SVT00	1900	5500	
		HLMP-ED25-TW000	HLMP-ED27-TW000	2500	7200	
		HLMP-ED25-TWT00	HLMP-ED27-TWT00	2500	7200	
	30°	Amber 592	HLMP-EL31-QRS00		1150	1900
			HLMP-EL31-QS000		1150	2500
HLMP-EL31-QSR00				1150	2500	
HLMP-EL31-QS400**				1150	2500	
HLMP-EL31-QSU00				1150	2500	
HLMP-EL31-OT000			HLMP-EL33-OT000	1150	3200	
HLMP-EL31-QTR00			HLMP-EL33-QTR00	1150	3200	
HLMP-EL31-QTK00*				1150	3200	
HLMP-EL31-QTS00				1150	3200	
HLMP-EL31-SV000			HLMP-EL33-SV000	1900	5500	
HLMP-EL31-SVR00			HLMP-EL33-SVR00	1900	5500	
HLMP-EL31-ST000				1900	3200	
HLMP-EL31-STR00				1900	3200	
HLMP-EL31-STK00*				1900	3200	
HLMP-EL31-STS00				1900	3200	
HLMP-EL31-SUK00*				1900	4200	

Notes:

1. Dominant Wavelength,  $\lambda_d$ , is derived from the CIE Chromaticity Diagram and represents the color of the lamp.
2.  $\theta_{1/2}$  is the off-axis angle where the luminous intensity is one half the on-axis intensity.
3. The luminous intensity is measured on the mechanical axis of the lamp package.
4. The optical axis is closely aligned with the package mechanical axis.

5. Tolerance for each intensity bin limit is  $\pm 15\%$ .

Part numbers in **bold** are recommended for new designs.

\*HLMP-xLxx-xxK00 are selected to amber color bins 2 and 4 only.

\*\*HLMP-xLxx-xx400 are selected to amber color bin 4 only.

T-1<sup>3</sup>/<sub>4</sub> (5 mm) Precision Optical Performance AllnGaP II Led Lamps (Continued)  
 Selection Guide

Typical Viewing Angle 2θ <sup>1/2</sup> (Deg.) <sup>[2]</sup>	Color and Dominant Wavelength (nm), Typ. <sup>[1]</sup>	Lamps Without Standoffs (Outline Drawing A)	Lamps With Standoffs (Outline Drawing B)	Luminous Intensity I <sub>v</sub> (mcd) <sup>[3,4]</sup> @ I(f) = 20 mA		
				Min.	Max.	
30°	Amber 592	HLMP-EL31-SUS00		1900	4200	
		HLMP-EL31-SU400**		1900	4200	
		HLMP-EL31-SUU00		1900	4200	
		HLMP-EL31-SU000		1900	4200	
		HLMP-EL31-SUR00		1900	4200	
		HLMP-EL31-SVK00*		1900	5500	
		HLMP-EL31-SVS00		1900	5500	
	Red-Orange 615	HLMP-EH31-PS000			880	2500
		HLMP-EH31-QT000	HLMP-EH33-QT000		1150	3200
		HLMP-EH31-RU000	HLMP-EH33-RU000		1500	4200
		HLMP-EH31-SV000	HLMP-EH33-SV000		1900	5500
		HLMP-EH31-SU000			1900	4200
	Red 630		HLMP-ED33-QT000		1150	3200
		HLMP-ED31-QTT00	HLMP-ED33-QTT00		1150	3200
		HLMP-ED31-ST000			1900	3200
		HLMP-ED31-STT00			1900	3200
		HLMP-ED31-SU000			1900	4200
		HLMP-ED31-SUT00			1900	4200
		HLMP-ED31-RU000	HLMP-ED33-RU000		1500	4200
		HLMP-ED31-RUT00	HLMP-ED33-RUT00		1500	4200
HLMP-ED31-SV000		HLMP-ED33-SV000		1900	5500	
HLMP-ED31-SVT00	HLMP-ED33-SVT00		1900	5500		

Notes:

1. Dominant Wavelength, λ<sub>d</sub>, is derived from the CIE Chromaticity Diagram and represents the color of the lamp.
2. θ<sub>1/2</sub> is the off-axis angle where the luminous intensity is one half the on-axis intensity.
3. The luminous intensity is measured on the mechanical axis of the lamp package.
4. The optical axis is closely aligned with the package mechanical axis.
5. Tolerance for each intensity bin limit is ± 15%.

Part numbers in **bold** are recommended for new designs.  
 \*HLMP-xLxx-xxK00 are selected to amber color bins 2 and 4 only.  
 \*\*HLMP-xLxx-xx400 are selected to amber color bin 4 only.

# Part Numbering System

HLMP- x x xx - x x x xx

**Mechanical Options**

- 00: Bulk Packaging
- DD: Ammo Pack
- YY: Flexi-Bin, Bulk Packaging
- ZZ: Flexi-Bin; Ammo Pack

**Color Bin & V<sub>F</sub> Selections**

- 0: No color bin limitation
- 4: Amber color bin 4 only
- K: Amber color bins 2 and 4 only
- L: Color bins 4 and 6
- R: Amber color bins 1, 2, 4, and 6 with V<sub>F</sub> max of 2.6 V
- S: Amber color bins 2 and 4 with V<sub>F</sub> max of 2.6 V
- T: Red color with V<sub>F</sub> max of 2.6 V
- U: Amber color bin 4 with V<sub>F</sub> max of 2.6 V
- W: Color bins 2, 4 and 6 with V<sub>F</sub> max of 2.6 V
- Y: Color bins 4 and 6 with V<sub>F</sub> max of 2.6 V

**Maximum Intensity Bin**

- 0: No I<sub>v</sub> bin limitation

**Minimum Intensity Bin**

**Viewing Angle and Lead Standoffs**

- 16: 15 degree without lead standoffs
- 18: 15 degree with lead standoffs
- 25: 23 degree without lead standoffs
- 27: 23 degree with lead standoffs
- 31: 30 degree without lead standoffs
- 33: 30 degree with lead standoffs

**Color**

- D: 630 nm Red
- H: 615 nm Red-Orange
- L: 592 nm Amber

**Package**

- E: 5 mm Round

# Package Dimensions

**A**

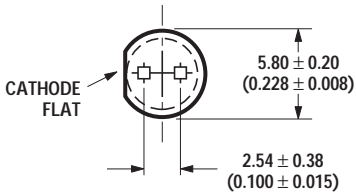
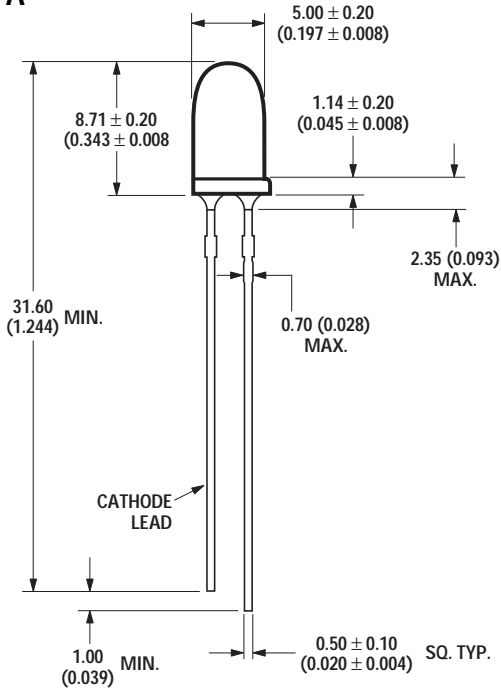

**B**

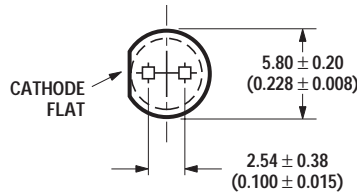
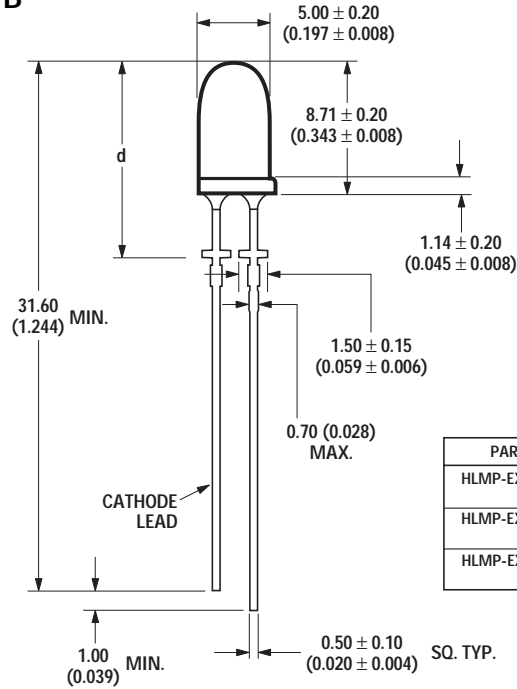

PART NO.	d
HLMP-EX18-xxxxx	12.60 ± 0.18 (0.496 ± 0.007)
HLMP-EX27-xxxxx	11.59 ± 0.25 (0.446 ± 0.010)
HLMP-EX33-xxxxx	11.99 ± 0.25 (0.472 ± 0.010)

## Absolute Maximum Ratings at T<sub>A</sub> = 25°C

DC Forward Current <sup>[1,2,3]</sup>	50 mA
Peak Pulsed Forward Current <sup>[2,3]</sup>	100 mA
Average Forward Current	30 mA
Reverse Voltage (I <sub>R</sub> = 100 μA)	5 V
LED Junction Temperature	130°C
Operating Temperature	-40°C to +100°C
Storage Temperature	-40°C to +120°C
Wave Solder Temperature	250°C for 3 seconds
Solder Dipping Temperature	260°C for 5 seconds [1.59 mm (0.060 in.) below body]

### Notes:

1. Derate linearly as shown in Figure 4.
2. For long term performance with minimal light output degradation, drive currents between 10 mA and 30 mA are recommended. For more information on recommended drive conditions, please refer to Application Brief I-024 (5966-3087E).
3. Please contact your sales representative about operating currents below 10 mA.

**Electrical/Optical Characteristics at  $T_A = 25^\circ\text{C}$**

Parameter	Symbol	Min.	Typ.	Max.	Units	Test Conditions
Forward Voltage						$I_F = 20\text{ mA}$
Amber ( $\lambda_d = 592\text{ nm}$ )	$V_F$		2.15	2.4 <sup>[1]</sup>	V	
Red-Orange ( $\lambda_d = 617\text{ nm}$ )			2.08			
Red ( $\lambda_d = 630\text{ nm}$ )			2.00			
Reverse Voltage	$V_R$	5	20		V	$I_R = 100\ \mu\text{A}$
Peak Wavelength						Peak of Wavelength of Spectral Distribution at $I_F = 20\text{ mA}$
Amber	$\lambda_{PEAK}$		594		nm	
Red-Orange			623			
Red			639			
Spectral Halfwidth Distribution	$\Delta\lambda_{1/2}$		17		nm	Wavelength Width at Spectral $1/2$ Power Point at $I_F = 20\text{ mA}$
Speed of Response	$\tau_s$		20		ns	Exponential Time Constant, $e^{-t/\tau_s}$
Capacitance	C		40		pF	$V_F = 0, f = 1\text{ MHz}$
Thermal Resistance	$R\Theta_{J-PIN}$		240		$^\circ\text{C/W}$	LED Junction-to-Cathode Lead
Luminous Efficacy <sup>[2]</sup>						Emitted Luminous Power/Emitted Radiant Power at $I_F = 20\text{ mA}$
Amber	$\eta_v$		500		lm/W	
Red-Orange			235			
Red			155			

**Notes:**

- For options -xxRxx, -xxSxx, -xxTxx, -xxUxx, -xxVxx, -xxYxx, max forward voltage ( $V_f$ ) is 2.6 V. Refer to  $V_f$  bin table.
- The radiant intensity,  $I_e$ , in watts per steradian, may be found from the equation  $I_e = I_v/\eta_v$ , where  $I_v$  is the luminous intensity in candelas and  $\eta_v$  is the luminous efficacy in lumens/watt.

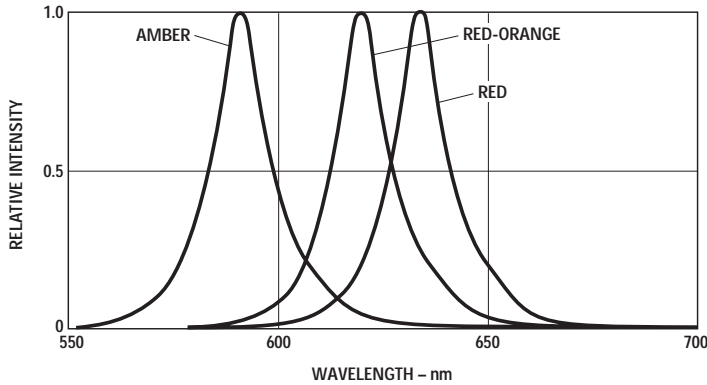

Figure 1. Relative Intensity vs. Peak Wavelength.

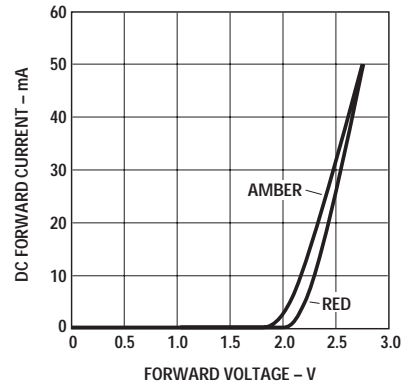

Figure 2a. Forward Current vs. Forward Voltage for Option -xxRxx, -xxSxx, -xxTxx, -xxUxx, -xxVxx and -xxYxx.



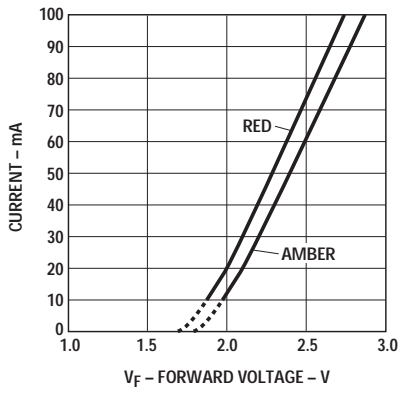

Figure 2b. Forward Current vs. Forward Voltage.

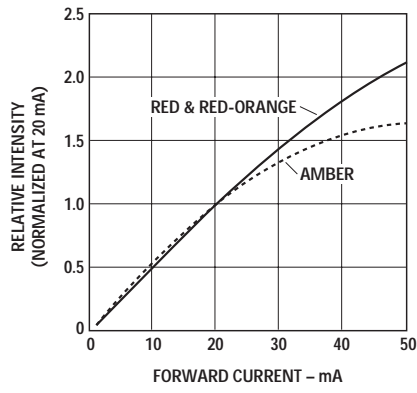

Figure 3. Relative Luminous Intensity vs. Forward Current.

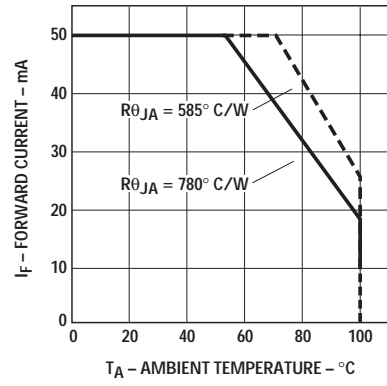

Figure 4. Maximum Forward Current vs. Ambient Temperature. Derating Based on  $T_{JMAX} = 130^{\circ}C$ .

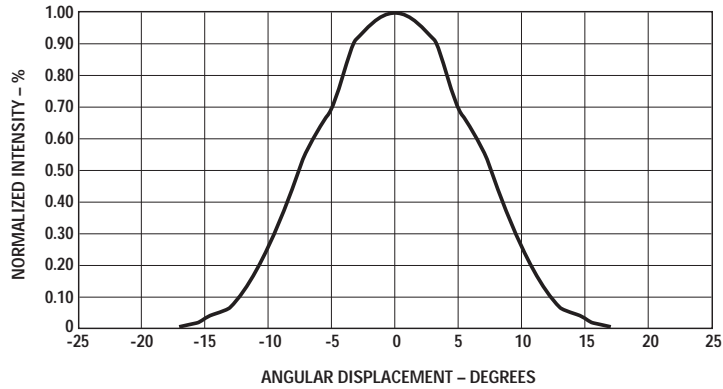

Figure 5. Representative Spatial Radiation Pattern for 15° Viewing Angle Lamps.

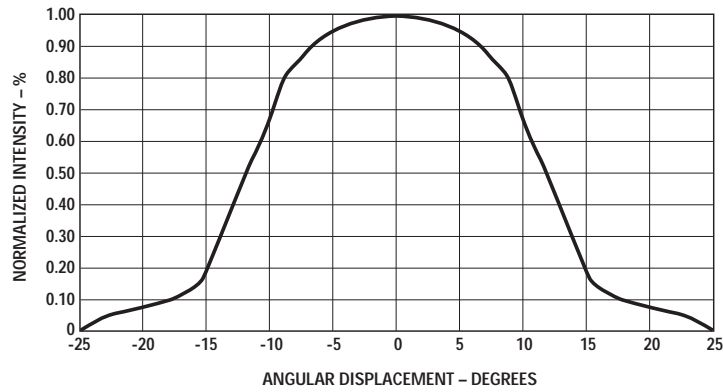

Figure 6. Representative Spatial Radiation Pattern for 23° Viewing Angle Lamps.

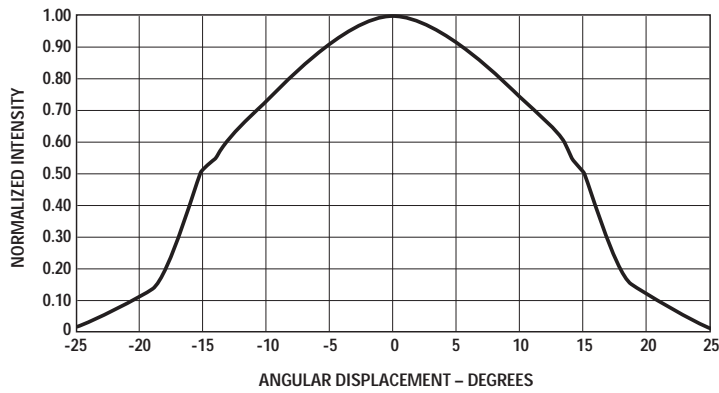

Figure 7. Representative Spatial Radiation Pattern for 30° Viewing Angle Lamps.

**Intensity Bin Limits  
(mcd at 20 mA)**

Bin Name	Min.	Max.
P	880	1150
Q	1150	1500
R	1500	1900
S	1900	2500
T	2500	3200
U	3200	4200
V	4200	5500
W	5500	7200
X	7200	9300
Y	9300	12000
Z	12000	16000

Tolerance for each bin limit is ±15%.

**Amber Color Bin Limits  
(nm at 20 mA)**

Bin Name	Min.	Max.
1	584.5	587.0
2	587.0	589.5
4	589.5	592.0
6	592.0	594.5

Tolerance for each bin limit is ±0.5 nm.

**Notes:**

1. Bin categories are established for classification of products. Products may not be available in all bin categories.
2. Vf Bin table only available for those part number with options -xxRxx, -xxSxx, -xxTxx, -xxUxx, -xxWxx, -xxYxx.

**Vf Bin Table<sup>[2]</sup>**

Bin Name	Min.	Max.
VA	2.0	2.2
VB	2.2	2.4
VC	2.4	2.6

Tolerance for each bin limit is ±0.05 V.

## Precautions

### Lead Forming

- The leads of an LED lamp may be preformed or trimmed to applicable length prior to insertion and soldering on PC board.
- If lead forming is required before soldering, care must be taken to avoid any excessive mechanical stress that is induced into the LED package. Otherwise, trim the leads to applicable length at room temperature after soldering process. The solder joint formed will absorb the mechanical stress, due to the lead cutting, from flowing to the wire bonding area and LED chip die attach.
- For better control, it is recommended to use proper tool to precisely form and cut the leads to applicable length rather than doing it manually.

### Soldering Condition

- Extra care must be taken during PCB assembly and soldering process to prevent damage to the LED component.
- The closest distance of manual soldering from the soldering heat source (soldering iron's tip) to the body is 1.59 mm. Damage might occur if the LED soldering distance is less than 1.59 mm. Please refer to the illustration below.

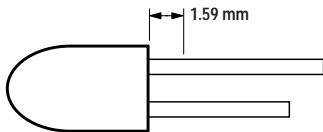

### Recommended Soldering Condition

	Wave Soldering	Manual Solder Dipping
Pre-Heat Temperature	105°C max.	–
Pre-Heat Time	30 sec max.	–
Peak Temperature	250°C max.	260°C max.
Dwell Time	3 sec max.	5 sec max.

- Wave soldering parameter must be set and maintained according to the recommended soldering condition. Customer is advised to daily check on the soldering profile to ensure that the soldering profile is always corresponding to Avago recommended soldering condition.

#### Notes:

1. PCB with different size and design (component density) will have different heat mass (heat capacity). This might cause a change in temperature experienced by the board if same wave soldering setting is used. So, it is recommended to recalibrate the soldering profile again before loading a new type of PCB.
2. Avago Technologies' high brightness LEDs use a high efficiency LED die with single wire bond, as shown below. Customer is advised to take extra precaution during wave soldering to ensure that the maximum wave temperature does not exceed 250°C. Over-stressing the LED during soldering process might cause premature failure to the LED due to delamination.

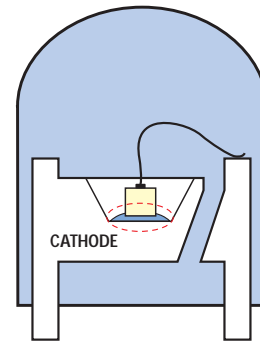

**Note:** Electrical connection between bottom surface of LED die and the lead frame material through conductive paste of solder.

- Special attention must be given to board fabrication, solder masking, surface plating and lead holes size and component orientation to assure the solderability.

### Recommended PC Board Plated Through Holes Size for LED Component Leads

LED Component Lead Size	Diagonal	Plated Through Hole Diameter
0.457 x 0.457 mm (0.018 x 0.018 inch)	0.646 mm (0.025 inch)	0.976 to 1.078 mm (0.038 to 0.042 inch)
0.508 x 0.508 mm (0.020 x 0.020 inch)	0.718 mm (0.028 inch)	1.049 to 1.150 mm (0.041 to 0.045 inch)

**Note:** Refer to Application Note AN1027 for more information on soldering LED components.

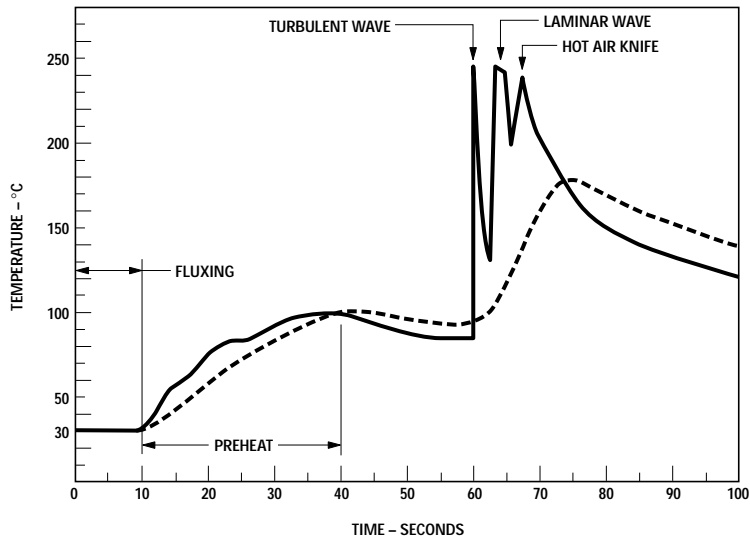

- - - TOP SIDE  
 OF PC BOARD  
 ——— BOTTOM SIDE  
 OF PC BOARD

CONVEYOR SPEED = 1.83 M/MIN (6 FT/MIN)  
 PREHEAT SETTING = 150°C (100°C PCB)  
 SOLDER WAVE TEMPERATURE = 245°C  
 AIR KNIFE AIR TEMPERATURE = 390°C  
 AIR KNIFE DISTANCE = 1.91 mm (0.25 IN.)  
 AIR KNIFE ANGLE = 40  
 LEAD SOLDER: SN63; FLUX: RMA  
 LEAD FREE SOLDER: 96.5 wt% Sn, 3.0 wt% Ag, 0.5 wt% Cu  
 NOTE: ALLOW FOR BOARDS TO BE SUFFICIENTLY COOLED  
 BEFORE EXERTING MECHANICAL FORCE.

For product information and a complete list of distributors, please go to our website: [www.avagotech.com](http://www.avagotech.com)

Avago, Avago Technologies, and the A logo are trademarks of Avago Technologies Limited in the United States and other countries.  
 Data subject to change. Copyright © 2006 Avago Technologies Limited. All rights reserved. Obsoletes 5989-3791EN  
 AV01-0701EN December 23, 2006

