

# ED2205/X

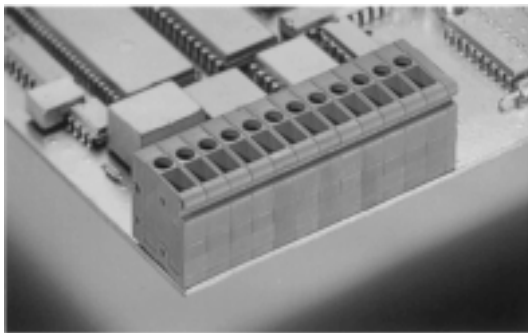

1-n poles, Spacing 5.0 mm  
insert required no. of poles **X**  
How to order see page 5



## Ratings:

Rated Voltage	300V	250 V
Rated Current	20 A	24 A (T60)
Wire Size	AWG 30-12	2.5 mm <sup>2</sup>
Test Voltage		2.0 kV
Rated Torque/ScrewSize		0.5 Nm/M2.5

## Max. Rated Cross Section

Single Wire (solid)	2.5 mm <sup>2</sup>
Stranded Wire (flexible)	2.5 mm <sup>2</sup>
Stranded wire with Ferrules	2.5 mm <sup>2</sup>

## Dimensions

Spacing	5.0 mm
PCB Hole Diameter	1.3 mm
Stripped Length	9.0 mm

## Materials

Insulating Material	PA
Flammability Class	UL94 V-0
Temperature Range	-30°C/+105°C
Clamp Cage	Fe/Fe
Wire Guard	Cu

## Color

Green

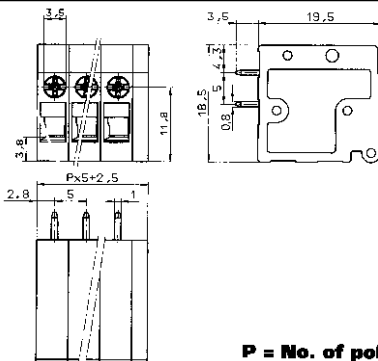

**P = No. of poles**