

QT-Brightek Display Series

0.56" Dual Digit Display

Part No.: QBD56XXZ

XX= Color

Z= 1: Common Cathode

Z = 0: Common Anode

Table of Contents:

Introduction	3
Electrical / Optical Characteristic (Ta=25 °C)	4
Absolute Maximum Rating	4
Pin Configuration	5
Characteristic Curves.....	6
Solder Profile	8
Packing	9
Ordering Information	10
Revision History	11
Disclaimer	11

Introduction

Feature:

- 0.56" dual digit seven segments display
- Low power consumption
- Packed in foam
- AllInGaP Technology R/S/Y/AG/O
- InGaN Technology IB/IG
- Z= 1: Common Cathode or 0:Common Anode
- XX= color

Description:

These 0.56" Dual-digit, seven-segment displays are made with white segments and a grey surface. The viewing distance is up to seven meters.

Application:

- Instrument panels
- Indoor/Outdoor display board
- Audio equipment

Certification & Compliance:

- TS16949
- ISO9001
- RoHS Compliant



Dimension:

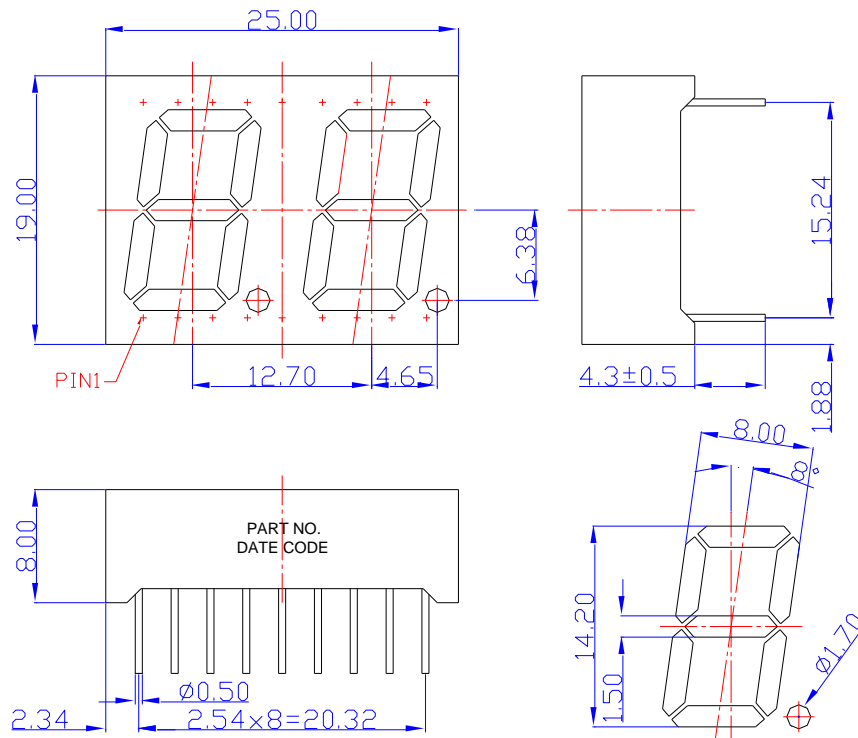

Units: mm / tolerance = +/-0.25mm

Electrical / Optical Characteristic (Ta=25 °C)

Product		Material	Color	I _F (mA)	V _F (V)		λ _D (nm)			I _V (mcd)
CC	CA				Typ.	Max.	Min.	Typ.	Max.	Typ.
QBD56R1	QBD56R0	AllnGaP	Red	20	2.0	2.6	-	624	-	60
QBD56S1	QBD56S0	AllnGaP	Deep Red	20	2.0	2.6	-	639	-	30
QBD56Y1	QBD56Y0	AllnGaP	Yellow	20	2.0	2.6	-	590	-	60
QBD56O1	QBD56O0	AllnGaP	Orange	20	2.0	2.6	-	606	-	60
QBD56AG1	QBD56AG0	AllnGaP	Yellow Green	20	2.1	2.6	-	571	-	25
QBD56IG1	QBD56IG0	InGaN	True Green	20	3.2	4.0	-	525	-	160
QBD56IB1	QBD56IB0	InGaN	Blue	20	3.0	4.0	-	465	-	60

Absolute Maximum Rating

Material	P _d (mW)	Derating liner from 25 °C per dice (mA/°C)	I _F (mA)	I _{PF} (mA)*	V _R (V)	T _{OP} (°C)	T _{ST} (°C)
AllnGaP	70	0.33	25	90	5	-25 to +85	-25 to +85
InGaN	120	0.4	30	100	5	-25 to +85	-25 to +85

*Duty 1/10 @ 1KHz

Pin Configuration

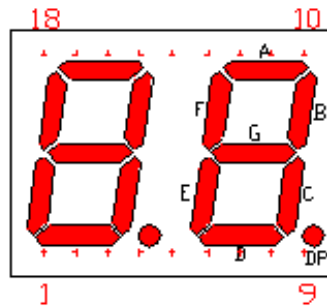

CC

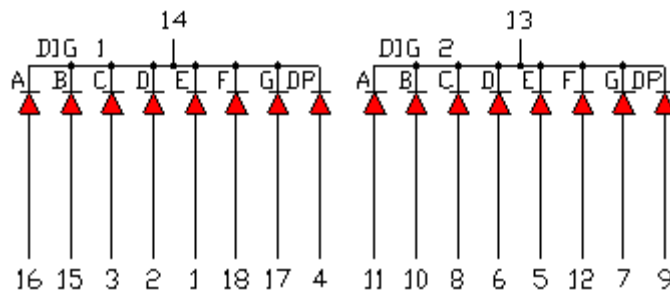

CA

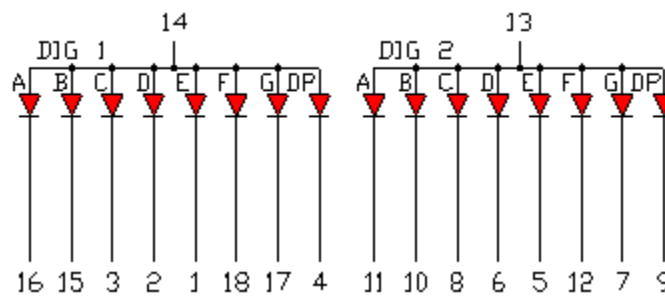

Characteristic Curves

AllnGaP

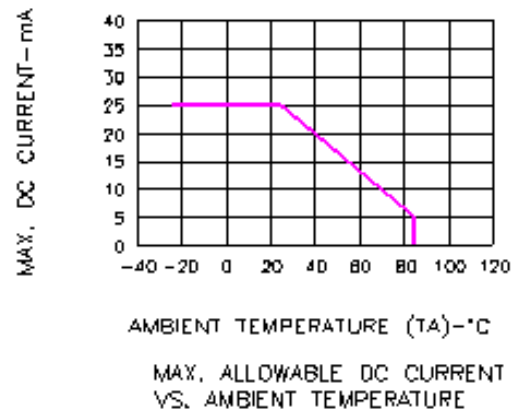
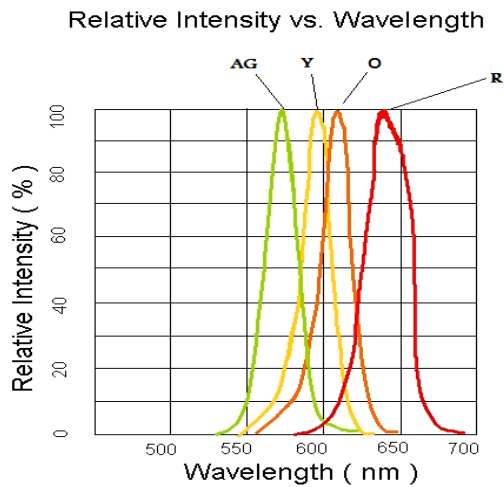
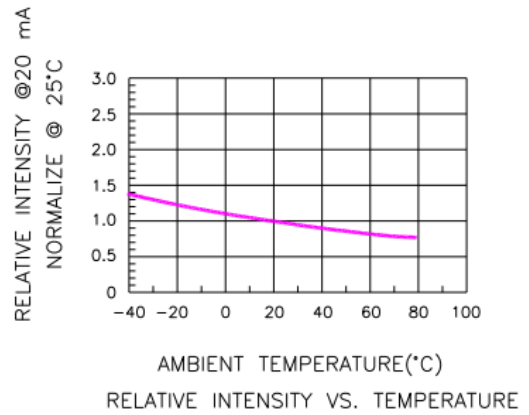
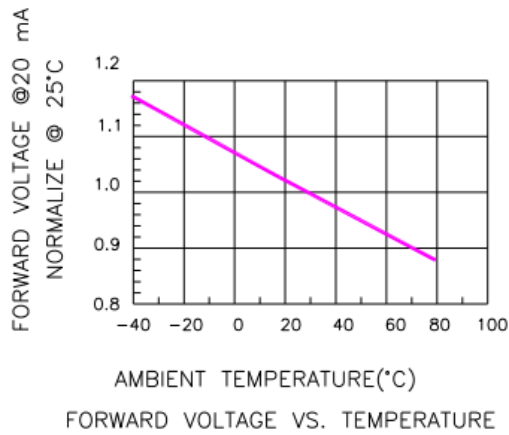
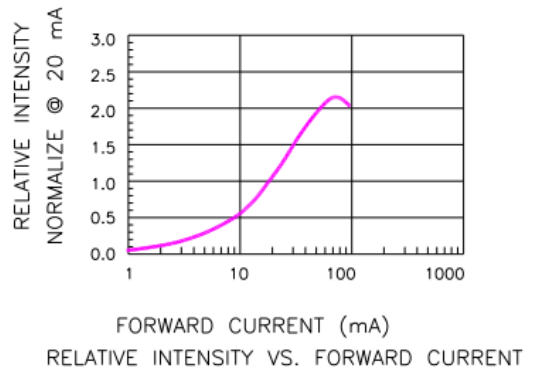
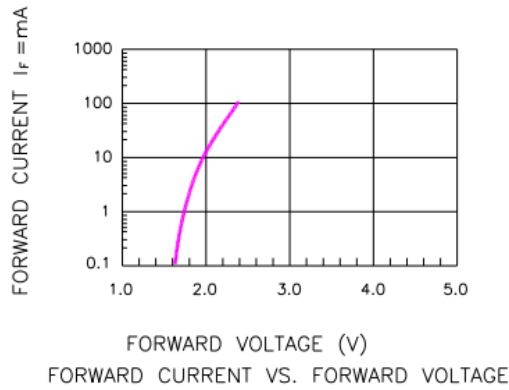

InGaN

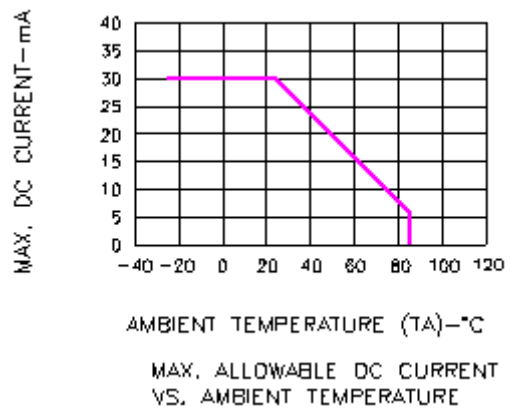
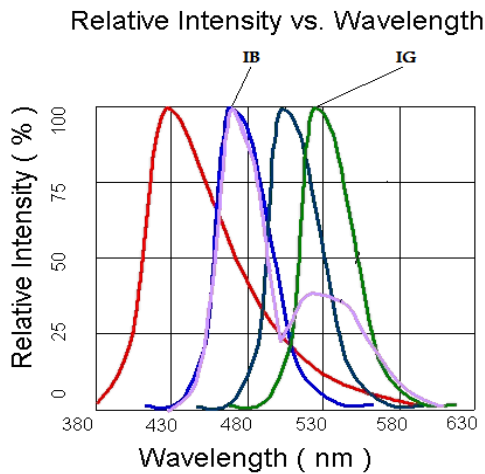
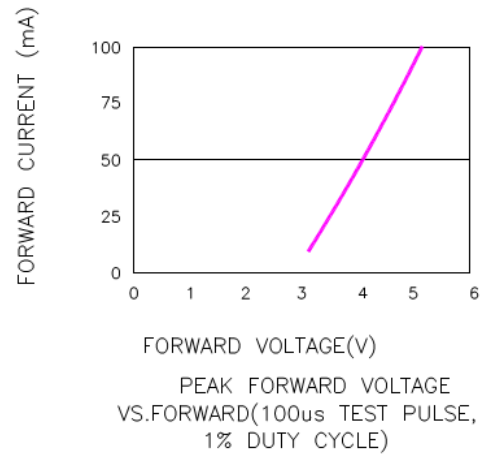
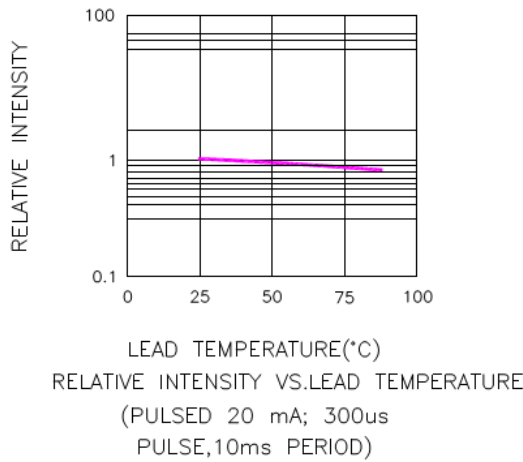
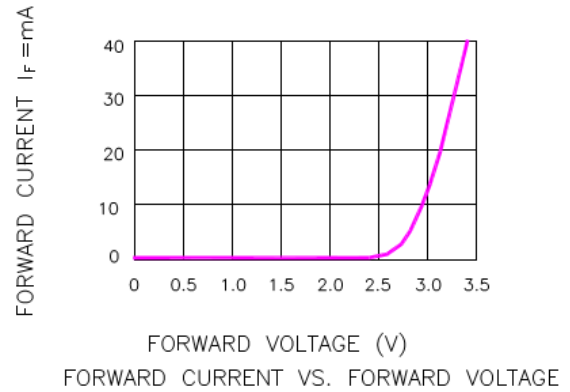
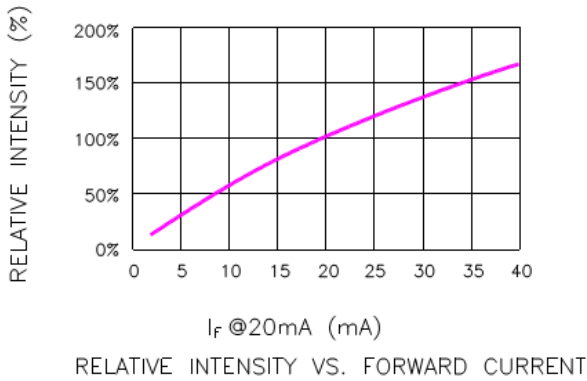

Solder Profile

Recommended Solder Profile

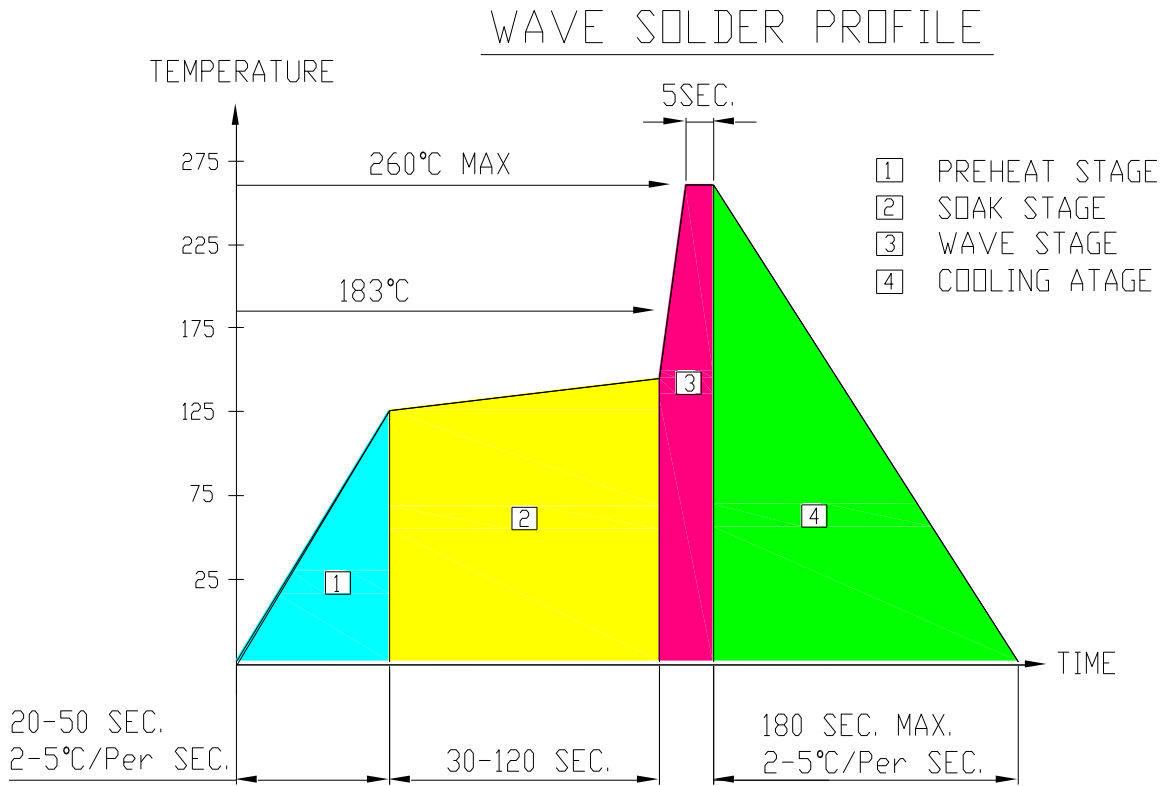

Packing

195 PCS (15X13) / 1 ANTISTATIC E. PE. FOAM SHEET

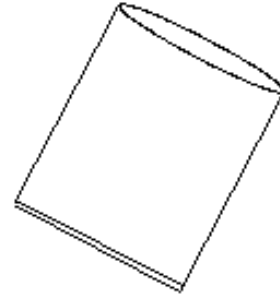
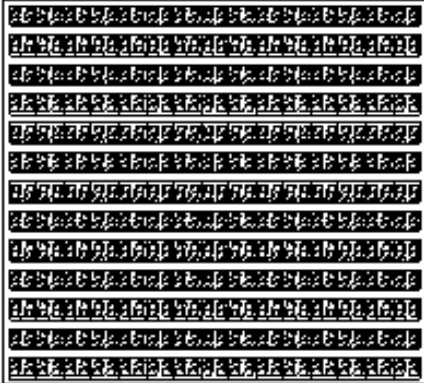

ESD BAG SIZE : 650 x 550 mm

5 ANTISTATIC E. PE. FOAM SHEET & 1 CARDBOARD / 1 PINK ESD BAG
975 PCS / 1 Inner Carton

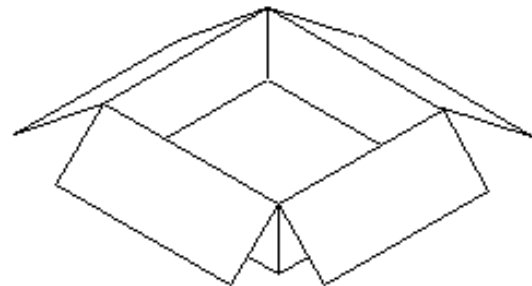

INNER BOX SIZE : 394 x 370 x 138 mm

1950 PCS / 2 Inner Carton / 1 Outer Carton

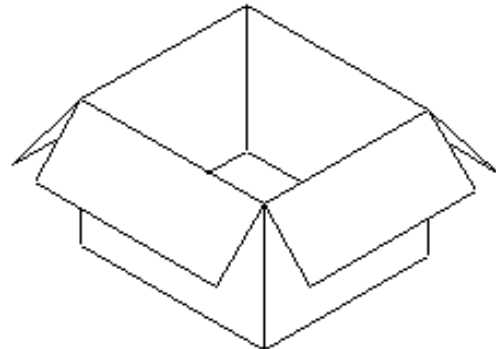

OUTER BOX SIZE : 430 x 390 x 300 mm

Ordering Information

Product		Orderable Part #		Spec Range	Quantity per foam
CC	CA	CC	CA		
QBD56R1	QBD56R0	QBD56R1	QBD56R0	I _v =60mcd typ. @ I _F =20mA, λ _D =624nm typ.	195pcs
QBD56S1	QBD56S0	QBD56S1	QBD56S0	I _v =30mcd typ. @ I _F =20mA, λ _D =639nm typ.	195pcs
QBD56Y1	QBD56Y0	QBD56Y1	QBD56Y0	I _v =60mcd typ. @ I _F =20mA, λ _D =590nm typ.	195pcs
QBD56O1	QBD56O0	QBD56O1	QBD56O0	I _v =60mcd typ. @ I _F =20mA, λ _D =606nm typ.	195pcs
QBD56AG1	QBD56AG0	QBD56AG1	QBD56AG0	I _v =25mcd typ. @ I _F =20mA, λ _D =571nm typ.	195pcs
QBD56IG1	QD56IG0	QBD56IG1	QBD56IG0	I _v =160mcd typ. @ I _F =20mA, λ _D =525nm typ.	195pcs
QBD56IB1	QBD56IB0	QBD56IB1	QBD56IB0	I _v =60mcd typ. @ I _F =20mA, λ _D =465nm typ.	195pcs

Revision History

Description:	Revision #	Revision Date
New Release of QBD56XXZ_series	V1.0	09/20/2010
Amend part number to QBD56XXZ / add color spec: blue and true green	V2.0	06/24/2011
Amend to the new format/ add color spec: Deep Red	V2.1	10/21/2013
Add packing spec / minor format update	V2.2	09/15/2015

Disclaimer

QT-BRIGHTTEK reserves the right to make changes without further notice to any products herein to improve reliability, function or design. QT-BRIGHTTEK does not assume any liability arising out of the application or use of any product or circuit described herein; neither does it convey any license under its patent rights, nor the rights of others.

Life Support Policy

QT-BRIGHTTEK's products are not authorized for use as critical components in life support devices or systems without the express written approval of QT-BRIGHTTEK. As used herein:

1. Life support devices or systems are devices or systems which, (a) are intended for surgical implant into the body, or (b) support or sustain life, and (c) whose failure to perform when properly used in accordance with instructions for use provided in the labeling, can be reasonably expected to result in a significant injury of the user.
2. A critical component in any component of a life support device or system whose failure to perform can be reasonably expected to cause the failure of the life support device or system, or to affect its safety or effectiveness.

Product: QBD56XXZ_series	Date: September 19, 2015	Page 11 of 11
	Version# 2.2	