

Turbo 2 ultrafast high voltage rectifier

Features

- Ultrafast switching
- Low reverse current
- Low thermal resistance
- Reduces switching and conduction losses
- Package insulation voltage:
 - DOP3I : 2500 V_{RMS}

Description

The STTH3006 uses ST Turbo 2 600 V technology and is especially suited for use in switching power supplies, and industrial applications, such as rectification and continuous mode PFC boost diode.

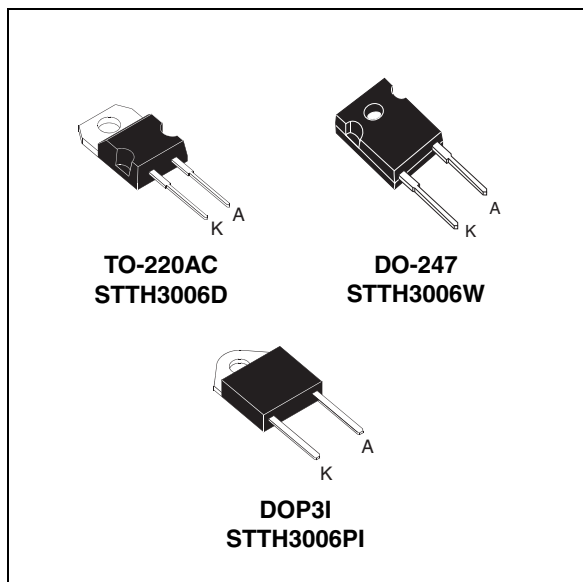

Table 1. Device summary

Symbol	Value
$I_{F(AV)}$	30 A
V_{RRM}	600 V
T_j	175 °C
V_F (typ)	1.10 V
t_{rr} (max)	50 ns

1 Characteristics

Table 2. Absolute Ratings (limiting values)

Symbol	Parameter		Value	Unit	
V_{RRM}	Repetitive peak reverse voltage		600	V	
$I_{F(RMS)}$	Forward rms voltage		50	A	
$I_{F(AV)}$	Average forward current	TO-220AC / DO-247	$T_c = 115\text{ °C } \delta = 0.5$	30	A
		DOP3I	$T_c = 85\text{ °C } \delta = 0.5$		
I_{FSM}	Surge non repetitive forward current		$t_p = 10\text{ ms sinusoidal}$	300	A
T_{stg}	Storage temperature range		-65 to + 175	°C	
T_j	Maximum operating junction temperature		175	°C	

Table 3. Thermal resistance

Symbol	Parameter		Value (max)	Unit
$R_{th(j-c)}$	Junction to case	TO-220AC / DO-247	1.1	°C/W
		DOP3I	1.7	

Table 4. Static electrical characteristic

Symbol	Parameter	Test conditions		Min.	Typ.	Max.	Unit
$I_R^{(1)}$	Reverse leakage current	$T_j = 25\text{ °C}$	$V_R = V_{RRM}$			25	μA
		$T_j = 150\text{ °C}$			80	800	
$V_F^{(2)}$	Forward voltage drop	$T_j = 25\text{ °C}$	$I_F = 30\text{ A}$			1.85	V
		$T_j = 150\text{ °C}$			1.10	1.40	

1. Pulse test: $t_p = 5\text{ ms}$, $\delta < 2\%$

2. Pulse test: $t_p = 380\text{ }\mu\text{s}$, $\delta < 2\%$

To evaluate the conduction losses use the following equation:

$$P = 1.07 \times I_{F(AV)} + 0.011 I_{F(RMS)}^2$$

Table 5. Dynamic characteristics

Symbol	Parameter	Test conditions		Min.	Typ.	Max.	Unit
t_{rr}	Reverse recovery time	$T_j = 25\text{ °C}$	$I_F = 0.5\text{ A}$, $I_{rr} = 0.25\text{ A}$, $I_R = 1\text{ A}$			50	ns
			$I_F = 1\text{ A}$, $di_F/dt = -50\text{ A}/\mu\text{s}$ $V_R = 30\text{ V}$		50	70	
I_{RM}	Reverse recovery current	$T_j = 125\text{ °C}$	$I_F = 30\text{ A}$, $V_R = 400\text{ V}$ $di_F/dt = -100\text{ A}/\mu\text{s}$		8	11	A
t_{fr}	Forward recovery time	$T_j = 25\text{ °C}$	$I_F = 30\text{ A}$, $di_F/dt = 100\text{ A}/\mu\text{s}$ $V_{FR} = 1.1 \times V_{Fmax}$			500	ns
V_{FP}	Forward recovery voltage	$T_j = 25\text{ °C}$	$I_F = 30\text{ A}$, $di_F/dt = 100\text{ A}/\mu\text{s}$ $V_{FR} = 1.1 \times V_{Fmax}$		2.5		V

Figure 1. Conduction losses versus average forward current

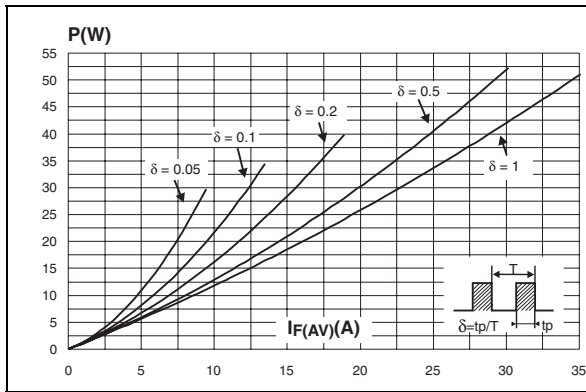

Figure 2. Forward voltage drop versus forward current

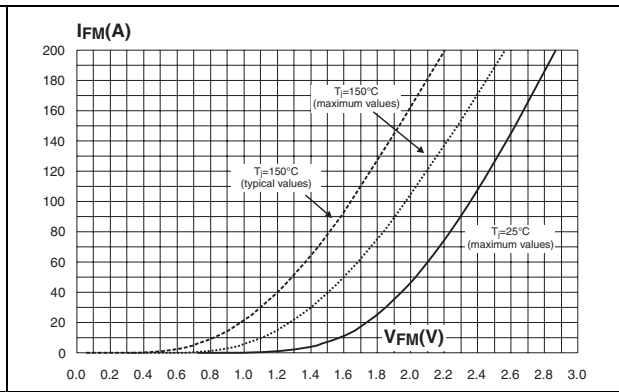

Figure 3. Relative variation of thermal impedance junction to case versus pulse duration

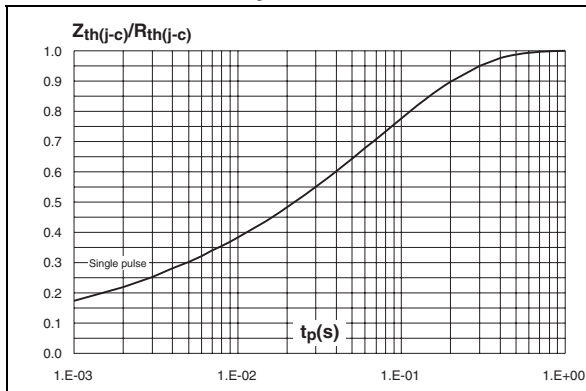

Figure 4. Peak reverse recovery current versus diF/dt (typical values)

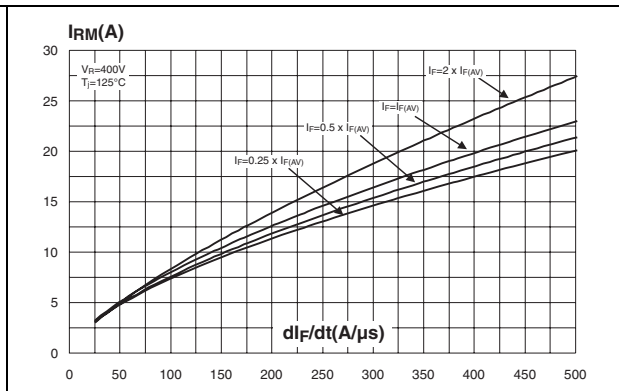

Figure 5. Reverse recovery time versus diF/dt (typical values)

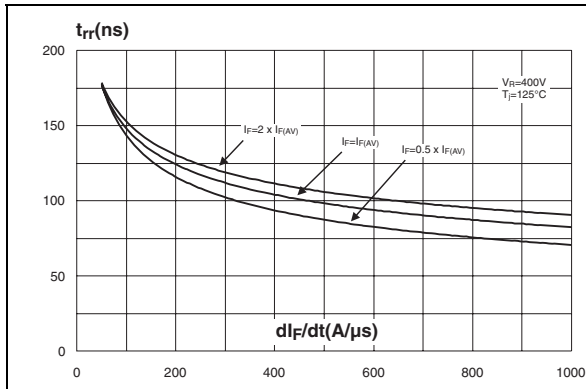

Figure 6. Reverse recovery charges versus diF/dt (typical values)

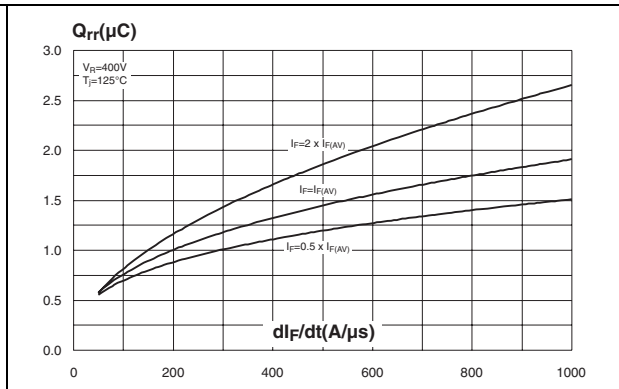

Figure 7. Softness factor versus di_F/dt (typical values)

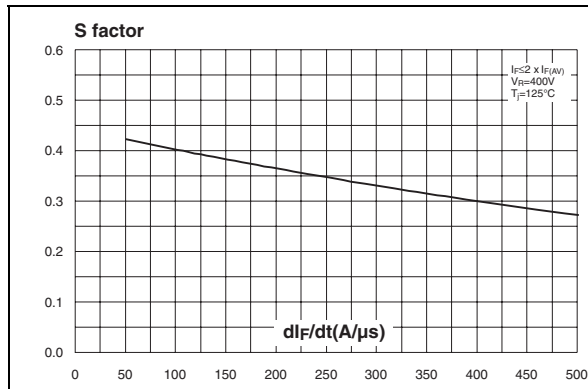

Figure 8. Relative variations of dynamic parameters versus junction temperature

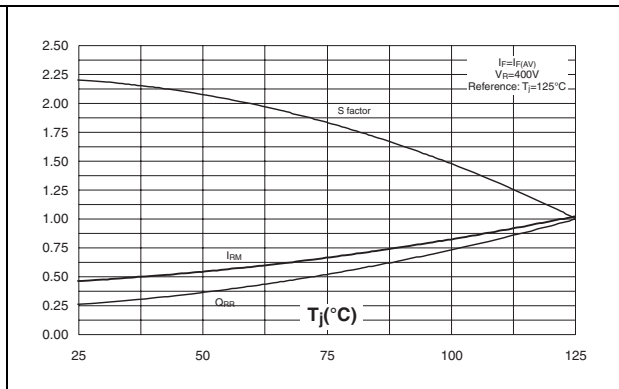

Figure 9. Transient peak forward voltage versus di_F/dt (typical values)

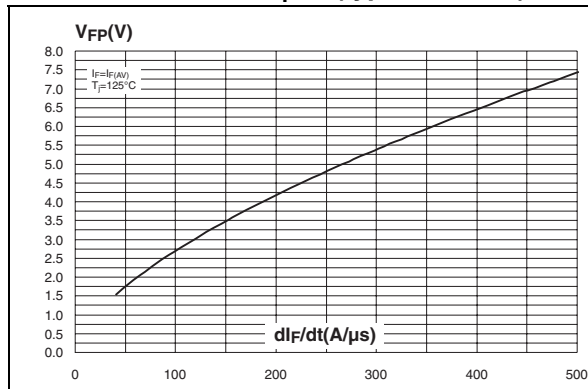

Figure 10. Forward recovery time versus di_F/dt (typical values)

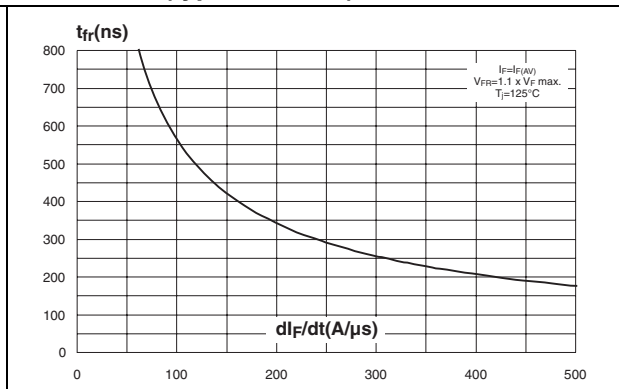
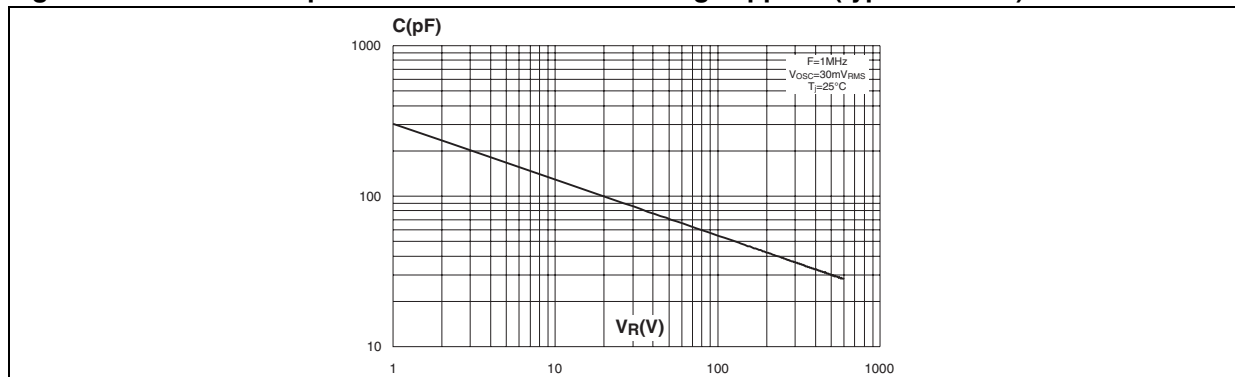

Figure 11. Junction capacitance versus reverse voltage applied (typical values)



2 Package information

- Epoxy meets UL94, V0
- Cooling method: by conduction (C)
- Recommended torque value: 0.4 to 0.6 N·m (TO-220AC)

In order to meet environmental requirements, ST offers these devices in different grades of ECOPACK® packages, depending on their level of environmental compliance. ECOPACK® specifications, grade definitions and product status are available at: www.st.com. ECOPACK® is an ST trademark.

Table 6. DO247 dimensions

Ref.	Dimensions					
	Millimeters			Inches		
	Min.	Typ.	Max.	Min.	Typ.	Max.
A	4.85		5.15	0.191		0.203
D	2.20		2.60	0.086		0.102
E	0.40		0.80	0.015		0.031
F	1.00		1.40	0.039		0.055
F2		2.00			0.078	
F3	2.00		2.40	0.078		0.094
G		10.90			0.429	
H	15.45		15.75	0.608		0.620
L	19.85		20.15	0.781		0.793
L1	3.70		4.30	0.145		0.169
L2		18.50			0.728	
L3	14.20		14.80	0.559		0.582
L4		34.60			1.362	
L5		5.50			0.216	
M	2.00		3.00	0.078		0.118
V		5°			5°	
V2		60°			60°	
Dia.	3.55		3.65	0.139		0.143

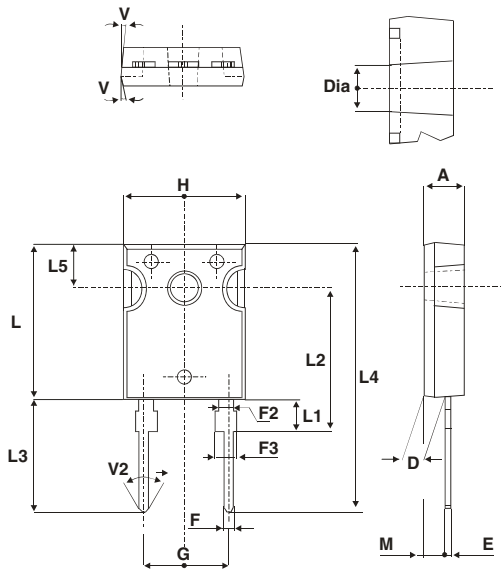

Table 7. TO-220AC dimensions

Ref.	Dimensions			
	Millimeters		Inches	
	Min.	Max.	Min.	Max.
A	4.40	4.60	0.173	0.181
C	1.23	1.32	0.048	0.051
D	2.40	2.72	0.094	0.107
E	0.49	0.70	0.019	0.027
F	0.61	0.88	0.024	0.034
F1	1.14	1.70	0.044	0.066
G	4.95	5.15	0.194	0.202
H2	10.00	10.40	0.393	0.409
L2	16.40 typ.		0.645 typ.	
L4	13.00	14.00	0.511	0.551
L5	2.65	2.95	0.104	0.116
L6	15.25	15.75	0.600	0.620
L7	6.20	6.60	0.244	0.259
L9	3.50	3.93	0.137	0.154
M	2.6 typ.		0.102 typ.	
Dia. I	3.75	3.85	0.147	0.151

Table 8. DOP3I dimensions

Ref.	Dimensions			
	Millimeters		Inches	
	Min.	Max.	Min.	Max.
A	4.40	4.60	0.173	0.181
b	1.20	1.40	0.047	0.055
c	1.45	1.55	0.057	0.061
c1	0.50	0.70	0.020	0.028
D	12.15	13.10	0.474	0.516
E	15.10	15.50	0.594	0.610
E1	7.55	7.75	0.297	0.305
e	10.80	11.30	0.425	0.445
G	20.4	21.10	0.815	0.831
L	14.35	15.60	0.565	0.614
P	4.08	4.17	0.161	0.164
Q	2.70	2.90	0.106	0.114
R	4.60 typ.		0.181 typ.	
Y	15.80	16.50	0.622	0.650

3 Ordering information

Table 9. Ordering information

Order code	Marking	Package	Weight	Base qty	Delivery mode
STTH3006D	STTH3006D	TO-220AC	1.90 g	50	Tube
STTH3006W	STTH3006W	DO-247	4.40 g	30	Tube
STTH3006PI	STTH3006PI	DOP3I	4.46 g	30	Tube

4 Revision history

Table 10. Document revision history

Date	Revision	Changes
22-May-2006	1	Initial release.
10-Aug-2006	2	Added Package insulation voltage on page 1 for DOP3I.
06-Sep-2011	3	Updated I_{FSM} from 160 A to 300 A.

Please Read Carefully:

Information in this document is provided solely in connection with ST products. STMicroelectronics NV and its subsidiaries ("ST") reserve the right to make changes, corrections, modifications or improvements, to this document, and the products and services described herein at any time, without notice.

All ST products are sold pursuant to ST's terms and conditions of sale.

Purchasers are solely responsible for the choice, selection and use of the ST products and services described herein, and ST assumes no liability whatsoever relating to the choice, selection or use of the ST products and services described herein.

No license, express or implied, by estoppel or otherwise, to any intellectual property rights is granted under this document. If any part of this document refers to any third party products or services it shall not be deemed a license grant by ST for the use of such third party products or services, or any intellectual property contained therein or considered as a warranty covering the use in any manner whatsoever of such third party products or services or any intellectual property contained therein.

UNLESS OTHERWISE SET FORTH IN ST'S TERMS AND CONDITIONS OF SALE ST DISCLAIMS ANY EXPRESS OR IMPLIED WARRANTY WITH RESPECT TO THE USE AND/OR SALE OF ST PRODUCTS INCLUDING WITHOUT LIMITATION IMPLIED WARRANTIES OF MERCHANTABILITY, FITNESS FOR A PARTICULAR PURPOSE (AND THEIR EQUIVALENTS UNDER THE LAWS OF ANY JURISDICTION), OR INFRINGEMENT OF ANY PATENT, COPYRIGHT OR OTHER INTELLECTUAL PROPERTY RIGHT.

UNLESS EXPRESSLY APPROVED IN WRITING BY TWO AUTHORIZED ST REPRESENTATIVES, ST PRODUCTS ARE NOT RECOMMENDED, AUTHORIZED OR WARRANTED FOR USE IN MILITARY, AIR CRAFT, SPACE, LIFE SAVING, OR LIFE SUSTAINING APPLICATIONS, NOR IN PRODUCTS OR SYSTEMS WHERE FAILURE OR MALFUNCTION MAY RESULT IN PERSONAL INJURY, DEATH, OR SEVERE PROPERTY OR ENVIRONMENTAL DAMAGE. ST PRODUCTS WHICH ARE NOT SPECIFIED AS "AUTOMOTIVE GRADE" MAY ONLY BE USED IN AUTOMOTIVE APPLICATIONS AT USER'S OWN RISK.

Resale of ST products with provisions different from the statements and/or technical features set forth in this document shall immediately void any warranty granted by ST for the ST product or service described herein and shall not create or extend in any manner whatsoever, any liability of ST.

ST and the ST logo are trademarks or registered trademarks of ST in various countries.

Information in this document supersedes and replaces all information previously supplied.

The ST logo is a registered trademark of STMicroelectronics. All other names are the property of their respective owners.

© 2011 STMicroelectronics - All rights reserved

STMicroelectronics group of companies

Australia - Belgium - Brazil - Canada - China - Czech Republic - Finland - France - Germany - Hong Kong - India - Israel - Italy - Japan - Malaysia - Malta - Morocco - Philippines - Singapore - Spain - Sweden - Switzerland - United Kingdom - United States of America

www.st.com