

## ADM3251E Evaluation Kit (EVAL-ADM3251EEB1Z) with Reduced EMI

### FEATURES

- 2.5 kV fully isolated (power and data) RS-232 transceiver**
- Convenient connections for power and signal through screw terminal blocks**
- 5 V operation**
- Easily configurable through jumper connections**
- Test points for measuring all signals**
- All external components required for correct operation**

### EVALUATION KIT CONTENTS

- ADM3251E evaluation board**
- 2 ADM3251E samples**

### GENERAL DESCRIPTION

The [ADM3251E](#) evaluation board can be used for easy evaluation of the ADM3251E power and signal isolated RS-232 transceiver. Screw terminal blocks provide convenient connections for the power and signal connections. Test points are included on the power and signal lines on both sides of the isolation barrier.

### RADIATED EMISSIONS

The ADM3251E evaluation board is designed to reduce emissions generated by the high frequency switching elements used by the *isoPower*® technology to transfer power through its transformer. Guidelines mentioned in the AN-0971 Application Note, *Recommendations for Control of Radiated Emissions with isoPower Devices*, were used to generate the layout. Guide guarding and a buried capacitive layer were implemented. The emissions of the evaluation board were measured by an independent test facility and passed the EN55022 (2001) Class B emissions standard.

### DIGITAL PICTURE OF EVALUATION BOARD

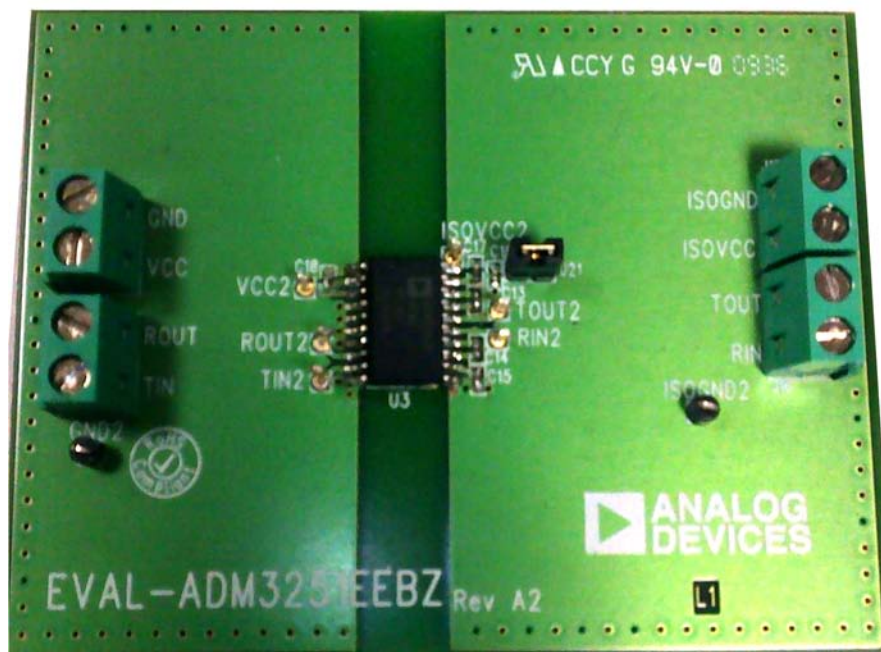

Figure 1.

**TABLE OF CONTENTS**

Features .....	1	Evaluation Board Hardware.....	3
Evaluation Kit Contents.....	1	Connector, Test Point, and Jumper Functions .....	3
General Description .....	1	Evaluation Board Schematic .....	4
Radiated Emissions .....	1	Assembly Drawings and Board Layout .....	5
Digital Picture of Evaluation Board .....	1	Ordering Information.....	8
Revision History .....	2	Bill of Materials.....	8

**REVISION HISTORY**

**4/10—Revision 0: Initial Version**

## EVALUATION BOARD HARDWARE

### CONNECTOR, TEST POINT, AND JUMPER FUNCTIONS

Table 1. Connector Functions

Connector	Name	Function
J15	Power connector	J15-1: connects positive supply of bench supply to the $V_{CC}$ plane J15-2: connects ground terminal of bench supply to the GND plane
J20	Terminal block	J20-1: connects to $R_{OUT}$ pin of <a href="#">ADM3251E</a> J20-2: connects to $T_{IN}$ pin of ADM3251E
J17	Power connector	J17-1: connects positive supply of the isolated bench supply to the $V_{ISO}$ plane J17-2: connects ground terminal of the isolated bench supply to the $GND_{ISO}$ plane
J16	Terminal block	J16-1: connects to $T_{OUT}$ pin of ADM3251E J16-2: connects to $R_{IN}$ pin of ADM3251E

Table 2. Test Point Functions

Test Point	Function
GND2	Connects to GND plane
VCC2	Connects to $V_{CC}$ plane
ROUT2	Connects to $R_{OUT}$ pin of the ADM3251E
TIN2	Connects to $T_{IN}$ pin of the ADM3251E
ISOVCC2	Connects to $V_{ISO}$ plane
TOUT2	Connects to $T_{OUT}$ pin of the ADM3251E device
RIN2	Connects to $R_{IN}$ pin of the ADM3251E device
ISOGND2	Connects to $GND_{ISO}$ plane

Table 3. Jumper Functions

Jumper	Function	Default
J21	Connects Pin 20 ( $V_{ISO}$ ) to J17-1	Inserted

# EVALUATION BOARD SCHEMATIC

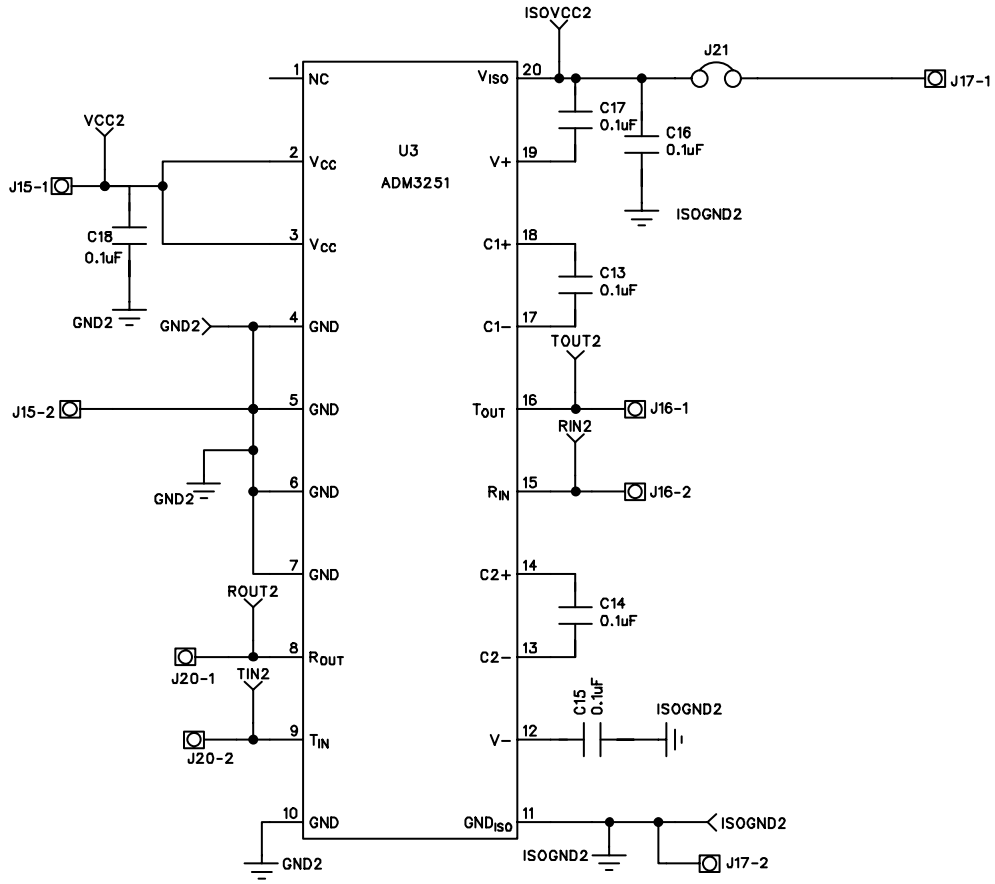

Figure 2. Schematic of the ADM3251E Evaluation Board

06874-002

# ASSEMBLY DRAWINGS AND BOARD LAYOUT

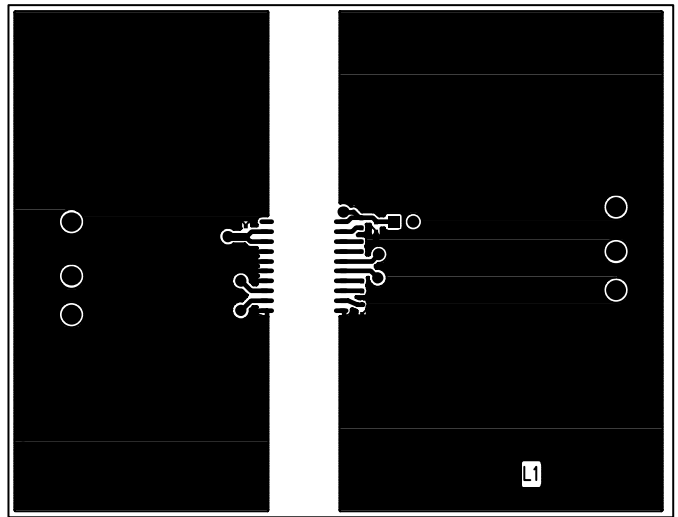

Figure 3. Top Layer

08974-003

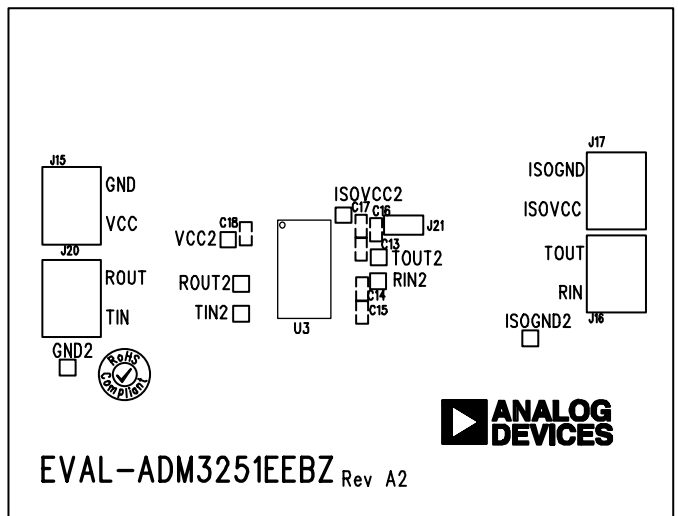

Figure 4. Silkscreen

08974-004

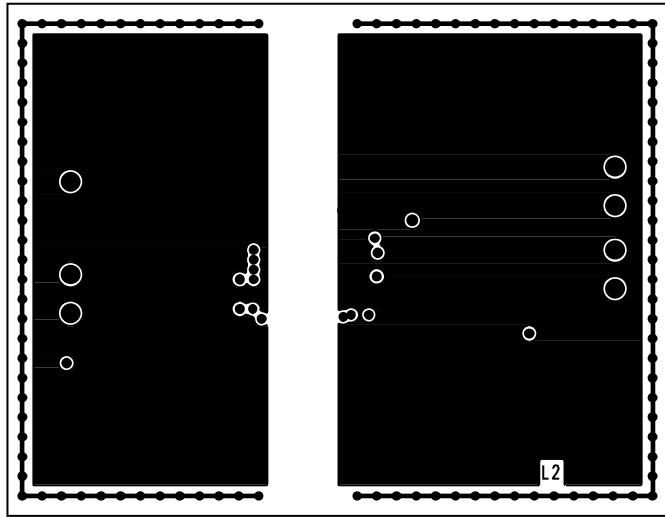

Figure 5. Internal Layer 2

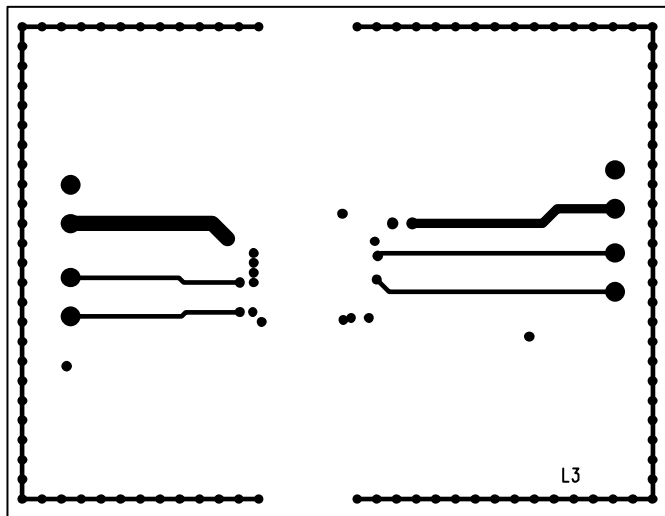

Figure 6. Internal Layer 3

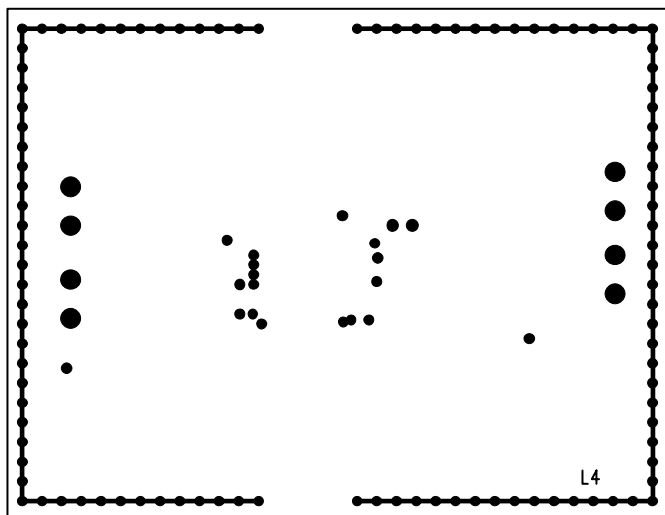

Figure 7. Internal Layer 4

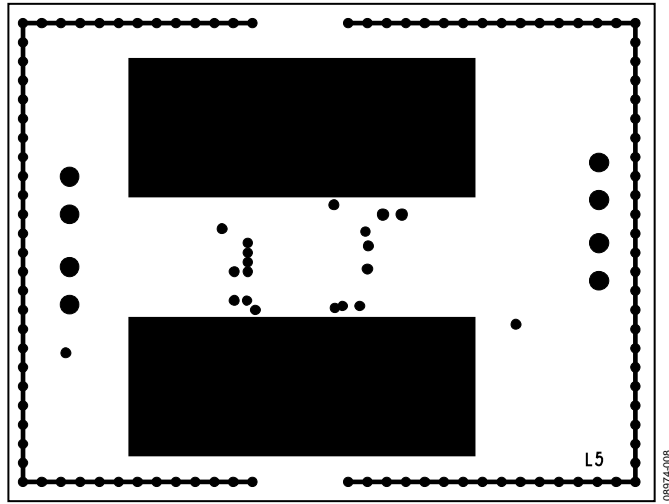

Figure 8. Internal Layer 5

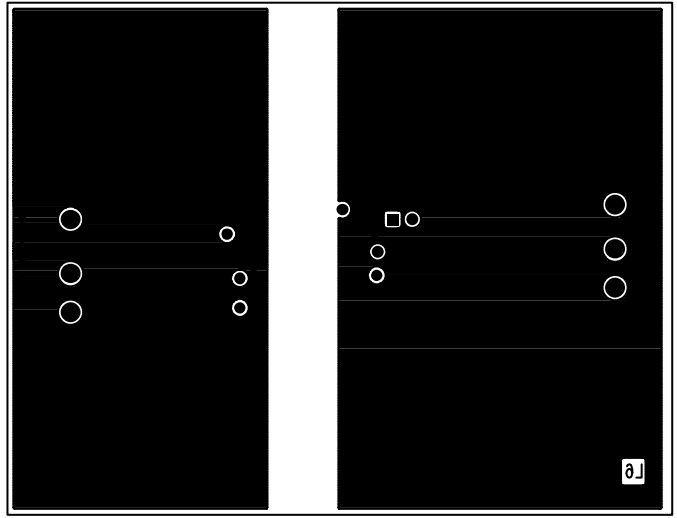

Figure 9. Bottom Solder Layer

## ORDERING INFORMATION

### BILL OF MATERIALS

Table 2.

Qty	Reference Designator	Part Type	Value	Part No.
6	C13, C14, C15, C16, C17, C18	Capacitor, 0402	0.1 $\mu$ F	FEC 1288252
8	GND2, ISOVCC2, ISOVCC2, RIN2, ROUT2, TIN2, TOUT2, VCC2	Test point		FEC 240333
4	J15, J16, J17, J20	Terminal block		FEC 151785
1	J21	Jumper		FEC 1022247 and FEC 150411
1	U3	Line driver/receiver		ADM3251EARWZ



#### ESD Caution

**ESD (electrostatic discharge) sensitive device.** Charged devices and circuit boards can discharge without detection. Although this product features patented or proprietary protection circuitry, damage may occur on devices subjected to high energy ESD. Therefore, proper ESD precautions should be taken to avoid performance degradation or loss of functionality.

#### Legal Terms and Conditions

By using the evaluation board discussed herein (together with any tools, components documentation or support materials, the "Evaluation Board"), you are agreeing to be bound by the terms and conditions set forth below ("Agreement") unless you have purchased the Evaluation Board, in which case the Analog Devices Standard Terms and Conditions of Sale shall govern. Do not use the Evaluation Board until you have read and agreed to the Agreement. Your use of the Evaluation Board shall signify your acceptance of the Agreement. This Agreement is made by and between you ("Customer") and Analog Devices, Inc. ("ADI"), with its principal place of business at One Technology Way, Norwood, MA 02062, USA. Subject to the terms and conditions of the Agreement, ADI hereby grants to Customer a free, limited, personal, temporary, non-exclusive, non-sublicensable, non-transferable license to use the Evaluation Board FOR EVALUATION PURPOSES ONLY. Customer understands and agrees that the Evaluation Board is provided for the sole and exclusive purpose referenced above, and agrees not to use the Evaluation Board for any other purpose. Furthermore, the license granted is expressly made subject to the following additional limitations: Customer shall not (i) rent, lease, display, sell, transfer, assign, sublicense, or distribute the Evaluation Board; and (ii) permit any Third Party to access the Evaluation Board. As used herein, the term "Third Party" includes any entity other than ADI, Customer, their employees, affiliates and in-house consultants. The Evaluation Board is NOT sold to Customer; all rights not expressly granted herein, including ownership of the Evaluation Board, are reserved by ADI. CONFIDENTIALITY. This Agreement and the Evaluation Board shall all be considered the confidential and proprietary information of ADI. Customer may not disclose or transfer any portion of the Evaluation Board to any other party for any reason. Upon discontinuation of use of the Evaluation Board or termination of this Agreement, Customer agrees to promptly return the Evaluation Board to ADI. ADDITIONAL RESTRICTIONS. Customer may not disassemble, decompile or reverse engineer chips on the Evaluation Board. Customer shall inform ADI of any occurred damages or any modifications or alterations it makes to the Evaluation Board, including but not limited to soldering or any other activity that affects the material content of the Evaluation Board. Modifications to the Evaluation Board must comply with applicable law, including but not limited to the RoHS Directive. TERMINATION. ADI may terminate this Agreement at any time upon giving written notice to Customer. Customer agrees to return to ADI the Evaluation Board at that time. LIMITATION OF LIABILITY. THE EVALUATION BOARD PROVIDED HEREUNDER IS PROVIDED "AS IS" AND ADI MAKES NO WARRANTIES OR REPRESENTATIONS OF ANY KIND WITH RESPECT TO IT. ADI SPECIFICALLY DISCLAIMS ANY REPRESENTATIONS, ENDORSEMENTS, GUARANTEES, OR WARRANTIES, EXPRESS OR IMPLIED, RELATED TO THE EVALUATION BOARD INCLUDING, BUT NOT LIMITED TO, THE IMPLIED WARRANTY OF MERCHANTABILITY, TITLE, FITNESS FOR A PARTICULAR PURPOSE OR NON-INFRINGEMENT OF INTELLECTUAL PROPERTY RIGHTS. IN NO EVENT WILL ADI AND ITS LICENSORS BE LIABLE FOR ANY INCIDENTAL, SPECIAL, INDIRECT, OR CONSEQUENTIAL DAMAGES RESULTING FROM CUSTOMER'S POSSESSION OR USE OF THE EVALUATION BOARD, INCLUDING BUT NOT LIMITED TO LOST PROFITS, DELAY COSTS, LABOR COSTS OR LOSS OF GOODWILL. ADI'S TOTAL LIABILITY FROM ANY AND ALL CAUSES SHALL BE LIMITED TO THE AMOUNT OF ONE HUNDRED US DOLLARS (\$100.00). EXPORT. Customer agrees that it will not directly or indirectly export the Evaluation Board to another country, and that it will comply with all applicable United States federal laws and regulations relating to exports. GOVERNING LAW. This Agreement shall be governed by and construed in accordance with the substantive laws of the Commonwealth of Massachusetts (excluding conflict of law rules). Any legal action regarding this Agreement will be heard in the state or federal courts having jurisdiction in Suffolk County, Massachusetts, and Customer hereby submits to the personal jurisdiction and venue of such courts. The United Nations Convention on Contracts for the International Sale of Goods shall not apply to this Agreement and is expressly disclaimed.