



## HIGH SPEED CMOS TIMER

### GENERAL DESCRIPTION

The ALD555 timer is a high performance monolithic timing circuit built with advanced silicon gate CMOS technology. It offers the benefits of high input impedance, thereby allowing smaller timing capacitors and longer timing cycle; high speed, with typical cycle time of 500ns; low power dissipation for battery operated environment; reduced supply current spikes, allowing smaller and lower cost decoupling capacitors. It is capable of producing accurate time delays and oscillations in both monostable and astable operation. It operates in the one-shot (monostable) mode or 50% duty cycle free running oscillation mode with a single resistor and one capacitor. The inputs and outputs are fully compatible with CMOS, NMOS or TTL logic.

There are three matched internal resistors (approximately 200KΩ each) that set the threshold and trigger levels at two-thirds and one-third respectively of V+. These levels can be adjusted by using the control terminal (pin 5). When the trigger input is below the trigger level, the output is in the high state and sourcing 2mA. When threshold input is above the threshold level at the same time the trigger input is above the trigger level, the internal flip-flop is reset, the output goes to the low state and sinks up to 10mA. The reset input overrides all other inputs and when it is active (reset voltage less than 1V), the output is in the low state.

### FEATURES

- Functional equivalent to NE555 with greatly expanded high and low frequency ranges
- High speed, low power, monolithic CMOS technology
- Low supply current: 100µA typical
- Extremely low trigger, threshold and reset currents: 1pA typical
- High speed operation -- 2MHz oscillation
- Low operating supply voltage of 2 to 12V
- Operates in both monostable and astable modes
- Fixed 50% duty cycle or adjustable duty cycle
- CMOS, NMOS and TTL compatible input/output
- High discharge sinking current of 80mA
- Low supply current spikes

### ORDERING INFORMATION ("L" suffix denotes lead-free (RoHS))

| Operating Temperature Range *      |                           |                      |
|------------------------------------|---------------------------|----------------------|
| 0°C to +70°C                       | 0°C to +70°C              | -55°C to +125°C      |
| 8-Pin Small Outline Package (SOIC) | 8-Pin Plastic DIP Package | 8-Pin CERDIP Package |
| ALD555SAL                          | ALD555PAL                 | ALD555DA             |

\* Contact factory for leaded (non-RoHS) or high temperature versions.

### APPLICATIONS

- High speed one-shot (monostable) pulse generation
- Precision timing
- Sequential timing
- Long delay timer
- Pulse width and pulse position modulation
- Missing pulse detector
- Frequency divider

### PIN CONFIGURATION

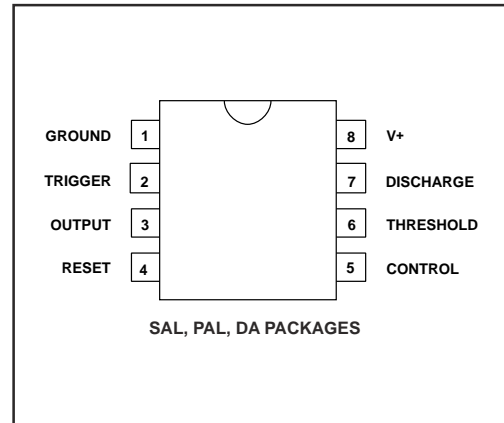

### BLOCK DIAGRAM

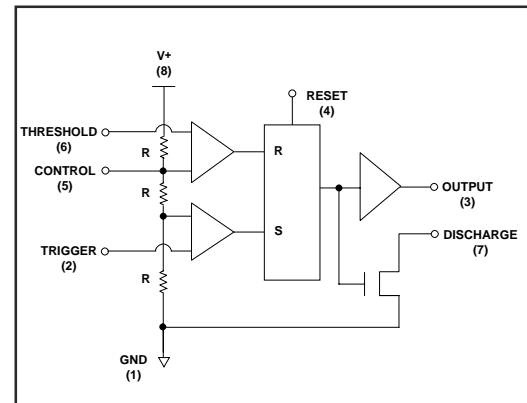

## ABSOLUTE MAXIMUM RATINGS

Supply voltage, V+ \_\_\_\_\_ 13.2V  
 Input voltage range \_\_\_\_\_ -0.3V to V+ +0.3V  
 Power dissipation \_\_\_\_\_ 600 mW  
 Operating temperature range SAL, PAL packages \_\_\_\_\_ 0°C to + 70°C  
 DA package \_\_\_\_\_ -55°C to +125°C  
 Storage temperature range \_\_\_\_\_ -65°C to +150°C  
 Lead temperature, 10 seconds \_\_\_\_\_ +260°C

## OPERATING ELECTRICAL CHARACTERISTICS T<sub>A</sub> = 25°C V+ = +5V unless otherwise specified

| Parameter   | Symbol            | Min   | Typ         | Max        | Unit          | Test Conditions  |
|---|-------------------|-------|-------------|------------|---------------|--|
| Supply Voltage  | V+                | 2     |             | 12         | V             |  |
| Supply Current  | I <sub>S</sub>    |       | 100         | 180        | μA            | Outputs Unloaded   |
| Timing error / Astable mode Initial Accuracy                                  | t <sub>err</sub>  |       | 1.0         | 2.2        | %             | C = 0.1μF  |
| Drift with Temperature <sup>1</sup><br>Drift with Supply Voltage <sup>1</sup> | Δt/ΔT<br>Δt/ΔV+   |       | 10.0<br>0.1 |            | ppm/°C<br>%/V | R <sub>A</sub> = 1KΩ<br>R <sub>B</sub> = 1KΩ                             |
| Threshold Voltage   | V <sub>TH</sub>   | 3.233 | 3.333       | 3.433      | V             |  |
| Trigger Voltage   | V <sub>TRIG</sub> | 1.607 | 1.667       | 1.737      | V             |  |
| Trigger Current <sup>2</sup>  | I <sub>TRIG</sub> |       | .001        | 0.2        | nA            |  |
| Reset Voltage   | V <sub>RST</sub>  | 0.4   | 0.7         | 1.0        | V             |  |
| Reset Current <sup>2</sup>  | I <sub>RST</sub>  |       | .001        | 0.2        | nA            |  |
| Threshold Current <sup>2</sup>  | I <sub>TH</sub>   |       | .001        | 0.2        | nA            |  |
| Control Voltage Level   | V <sub>CONT</sub> | 3.273 | 3.333       | 3.393      | V             |  |
| Output Voltage Drop (Low)   | V <sub>OL</sub>   |       | 0.2         | 0.4        | V             | I <sub>SINK</sub> = 10mA   |
| Output Voltage Drop (High)  | V <sub>OH</sub>   |       |             | 4.2        | V             | I <sub>SOURCE</sub> = -2mA   |
| Rise Time of Output <sup>1</sup>  | t <sub>r</sub>    |       | 15          | 30         | ns            | R <sub>L</sub> = 10MΩ  |
| Fall Time of Output <sup>1</sup>  | t <sub>f</sub>    |       | 10          | 30         | ns            | C <sub>L</sub> = 10pF  |
| Discharge Transistor Leakage Current  | I <sub>DL</sub>   |       | .01         |            | nA            |  |
| Discharge Voltage Drop  | V <sub>DISC</sub> |       | 0.5<br>0.2  | 1.0<br>0.4 | V<br>V        | I <sub>DISCHARGE</sub> = 80mA<br>I <sub>DISCHARGE</sub> = 30mA           |
| Maximum Frequency Astable Mode  | f <sub>MAX</sub>  | 1.4   | 2           |            | MHz           | R <sub>A</sub> = 470Ω<br>R <sub>B</sub> = 200Ω<br>C <sub>T</sub> = 200pF |

Notes: <sup>1</sup> Sample tested parameters.

<sup>2</sup> Consists of junction leakage currents with strong temperature dependence.

# TYPICAL PERFORMANCE CHARACTERISTICS

**DISCHARGE OUTPUT SINK CURRENT AS A FUNCTION OF DISCHARGE LOW VOLTAGE**

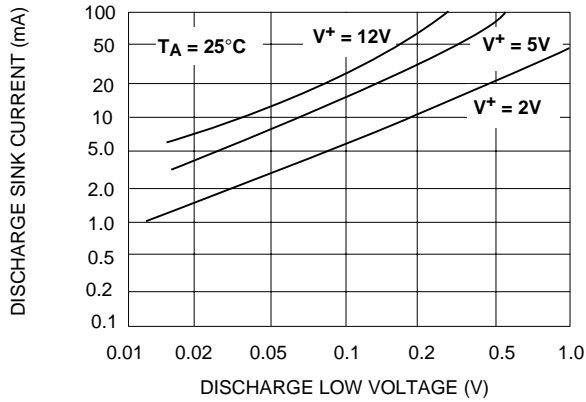

**MINIMUM PULSE WIDTH REQUIRED FOR TRIGGERING**

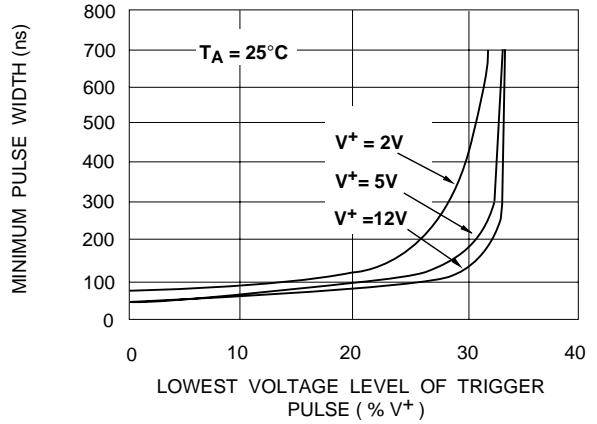

**FREE RUNNING FREQUENCY AS A FUNCTION OF  $R_A$ ,  $R_B$  AND C**

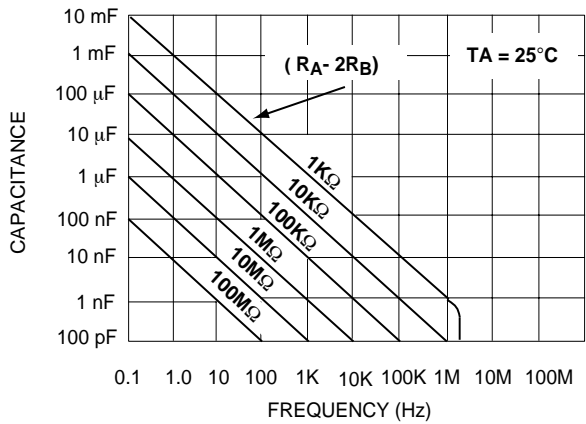

**FREQUENCY CHANGE IN THE ASTABLE MODE AS A FUNCTION OF SUPPLY VOLTAGE**

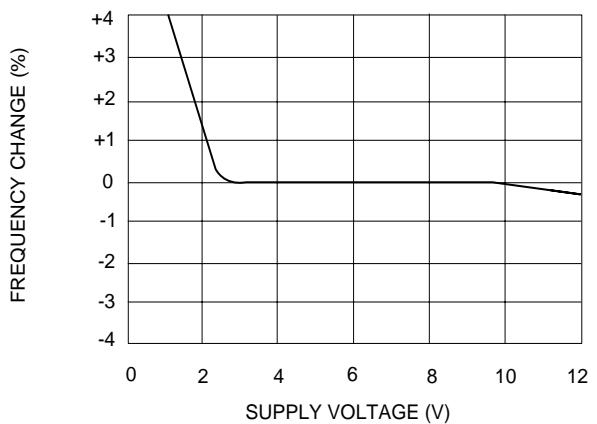

**TIME DELAY IN THE MONOSTABLE MODE AS A FUNCTION OF  $R_A$  AND C**

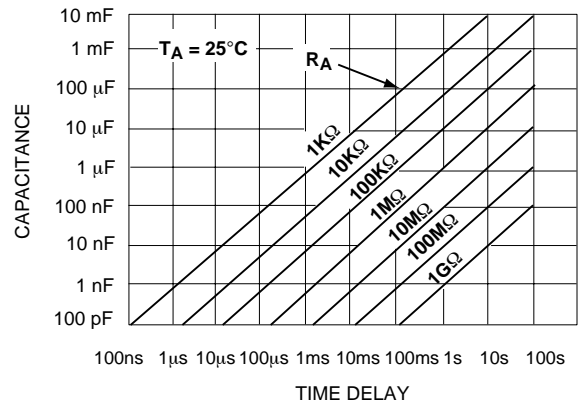

**SUPPLY CURRENT AS A FUNCTION OF SUPPLY VOLTAGE**

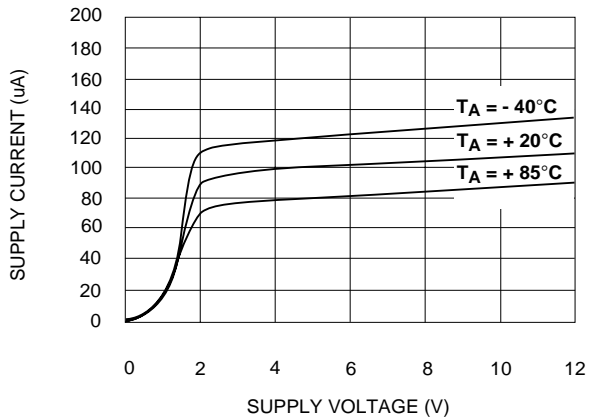

## TYPICAL PERFORMANCE CHARACTERISTICS (cont'd)

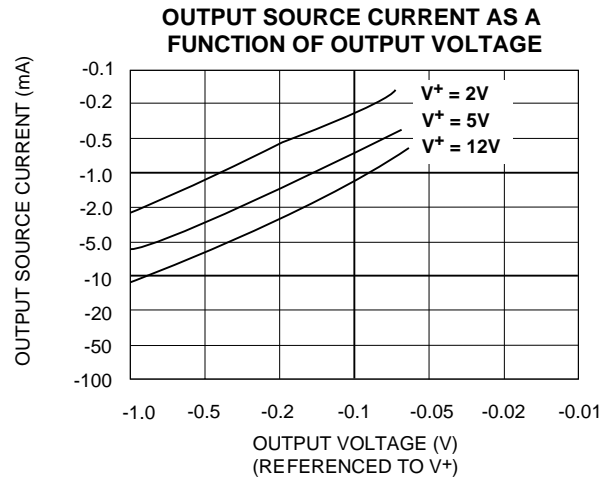
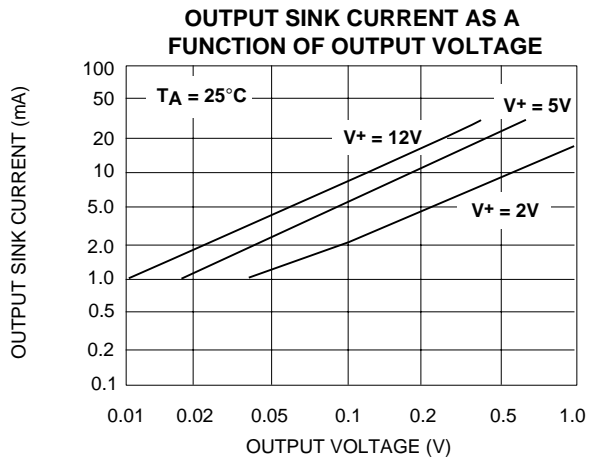

## TYPICAL APPLICATIONS

### ASTABLE MODE OPERATION 50% DUTY CYCLE

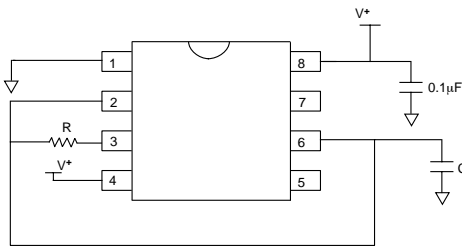

$$\text{Frequency } f = 1 / (1.4 R C)$$

### ASTABLE MODE OPERATION (FREE RUNNING OSCILLATOR)

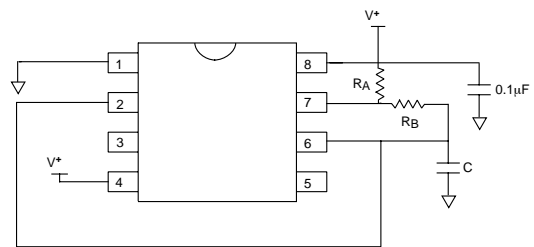

$$\text{Frequency } f = 1.46 / (R_A + 2R_B)C$$

$$\text{Duty Cycle DC} = R_B / (R_A + 2R_B)$$

### MONOSTABLE MODE OPERATION (ONE SHOT PULSE)

Pulse Delay  $t_d = 1.1 R C$

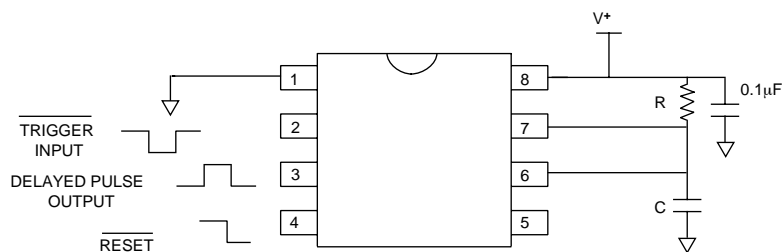

# SOIC-8 PACKAGE DRAWING

## 8 Pin Plastic SOIC Package

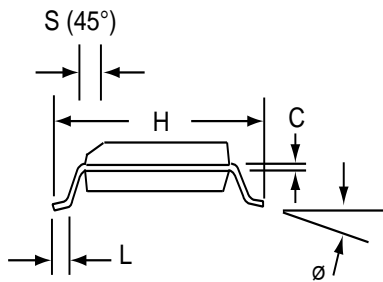
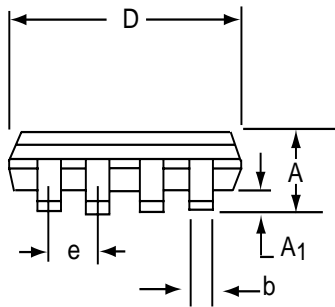
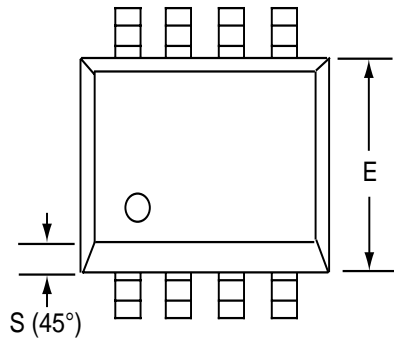

| Dim            | Millimeters |       | Inches    |       |
|----------------|-------------|-------|-----------|-------|
|                | Min         | Max   | Min       | Max   |
| A              | 1.35        | 1.75  | 0.053     | 0.069 |
| A <sub>1</sub> | 0.10        | 0.25  | 0.004     | 0.010 |
| b              | 0.35        | 0.45  | 0.014     | 0.018 |
| C              | 0.18        | 0.25  | 0.007     | 0.010 |
| D-8            | 4.69        | 5.00  | 0.185     | 0.196 |
| E              | 3.50        | 4.05  | 0.140     | 0.160 |
| e              | 1.27 BSC    |       | 0.050 BSC |       |
| H              | 5.70        | 6.30  | 0.224     | 0.248 |
| L              | 0.60        | 0.937 | 0.024     | 0.037 |
| ø              | 0°          | 8°    | 0°        | 8°    |
| S              | 0.25        | 0.50  | 0.010     | 0.020 |

# PDIP-8 PACKAGE DRAWING

## 8 Pin Plastic DIP Package

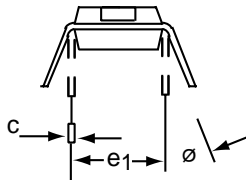
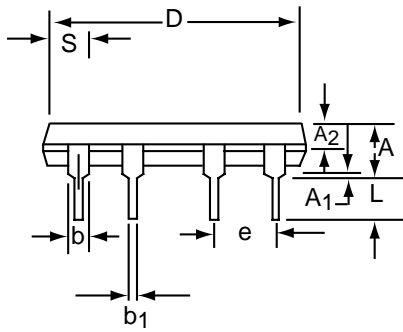
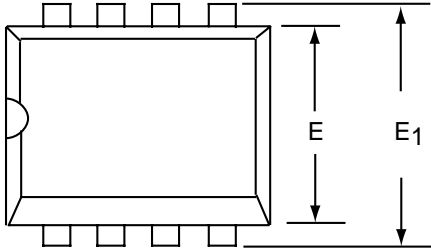

| Dim            | Millimeters |       | Inches |       |
|----------------|-------------|-------|--------|-------|
|                | Min         | Max   | Min    | Max   |
| A              | 3.81        | 5.08  | 0.105  | 0.200 |
| A <sub>1</sub> | 0.38        | 1.27  | 0.015  | 0.050 |
| A <sub>2</sub> | 1.27        | 2.03  | 0.050  | 0.080 |
| b              | 0.89        | 1.65  | 0.035  | 0.065 |
| b <sub>1</sub> | 0.38        | 0.51  | 0.015  | 0.020 |
| c              | 0.20        | 0.30  | 0.008  | 0.012 |
| D-8            | 9.40        | 11.68 | 0.370  | 0.460 |
| E              | 5.59        | 7.11  | 0.220  | 0.280 |
| E <sub>1</sub> | 7.62        | 8.26  | 0.300  | 0.325 |
| e              | 2.29        | 2.79  | 0.090  | 0.110 |
| e <sub>1</sub> | 7.37        | 7.87  | 0.290  | 0.310 |
| L              | 2.79        | 3.81  | 0.110  | 0.150 |
| S-8            | 1.02        | 2.03  | 0.040  | 0.080 |
| ∅              | 0°          | 15°   | 0°     | 15°   |

# CERDIP-8 PACKAGE DRAWING

## 8 Pin CERDIP Package

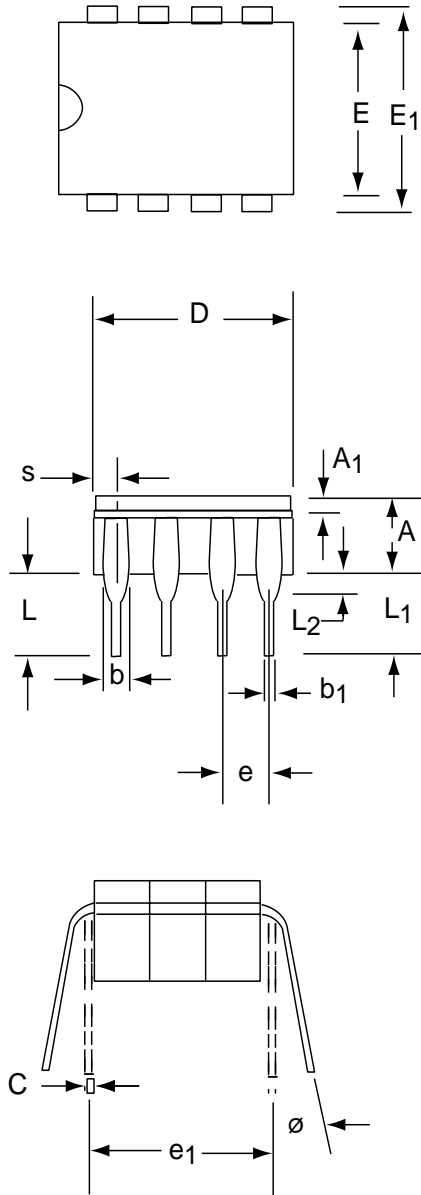

| Dim                  | Millimeters |       | Inches    |       |
|----------------------|-------------|-------|-----------|-------|
|                      | Min         | Max   | Min       | Max   |
| <b>A</b>             | 3.55        | 5.08  | 0.140     | 0.200 |
| <b>A<sub>1</sub></b> | 1.27        | 2.16  | 0.050     | 0.085 |
| <b>b</b>             | 0.97        | 1.65  | 0.038     | 0.065 |
| <b>b<sub>1</sub></b> | 0.36        | 0.58  | 0.014     | 0.023 |
| <b>C</b>             | 0.20        | 0.38  | 0.008     | 0.015 |
| <b>D-8</b>           | --          | 10.29 | --        | 0.405 |
| <b>E</b>             | 5.59        | 7.87  | 0.220     | 0.310 |
| <b>E<sub>1</sub></b> | 7.73        | 8.26  | 0.290     | 0.325 |
| <b>e</b>             | 2.54 BSC    |       | 0.100 BSC |       |
| <b>e<sub>1</sub></b> | 7.62 BSC    |       | 0.300 BSC |       |
| <b>L</b>             | 3.81        | 5.08  | 0.150     | 0.200 |
| <b>L<sub>1</sub></b> | 3.18        | --    | 0.125     | --    |
| <b>L<sub>2</sub></b> | 0.38        | 1.78  | 0.015     | 0.070 |
| <b>S</b>             | --          | 2.49  | --        | 0.098 |
| <b>∅</b>             | 0°          | 15°   | 0°        | 15°   |