





## 456 Series Fuse







### Agency Approvals

AGENCY	AGENCY FILE NUMBER	AMPERE RATING
	E10480	20A - 40A
	T50291892	20A - 30A
	NBK030308-JP1021	20A - 30A
	29862	20A - 40A

### Electrical Characteristics

% of Ampere Rating	Opening Time
100%	4 hours, Minimum
200%	60 seconds, Maximum

### Electrical Specifications

Ampere Rating (A)	Amp Code	Max Voltage Rating (V)	Interrupting Rating	Nominal Cold Resistance (Ohms)	Nominal Melting I <sup>2</sup> t (A <sup>2</sup> Sec.)	Nom Voltage Drop (mV)	Agency Approvals			
										
20	020.	125	100A @125VAC 300A @ 65VAC 300A @ 100VDC 1000A @ 32VDC 500A @ 72VDC	0.00230	18	64.7	x	x	x	x
25	025.	125	100A @ 125VAC 300A @ 65VAC 500A @ 72VDC 1000A @ 32VDC	0.00192	45	68.38	x	x	x	x
30	030.	125	100A @ 125VAC 300A @ 65VAC 1000A @ 32VDC 500A @ 72VDC	0.00132	81	69.9	x	x	x	x
40	040.	72	180A @ 72VDC 600A @ 60VDC	0.00105	191	55	x			x

Notes:  
 1. Cold resistance measured at less than 10% of rated current at 23°C.  
 2. Agency Approval Table Key: X=Approved or Certified, P=Pending.  
 3. I<sup>2</sup>t values stated for 1 msec opening time.

### Description

The High Current NANO<sup>2</sup><sup>®</sup> Fuse is a small square surface mount fuse that is designed to support higher current requirements of various applications.

### Features

- Surface mount high current fuse
- Fully compatible with lead-free solder alloys and higher temperature profiles associated with lead-free assembly
- RoHS compliant and Halogen Free
- Available in ratings of 20 to 40 Amperes

### Applications

- Voltage regulator module for PC server
- Cooling fan system for PC server
- Storage system power
- Basestation power supply

### Additional Information



Datasheet



Resources



Samples

**Temperature Re-rating Curve**

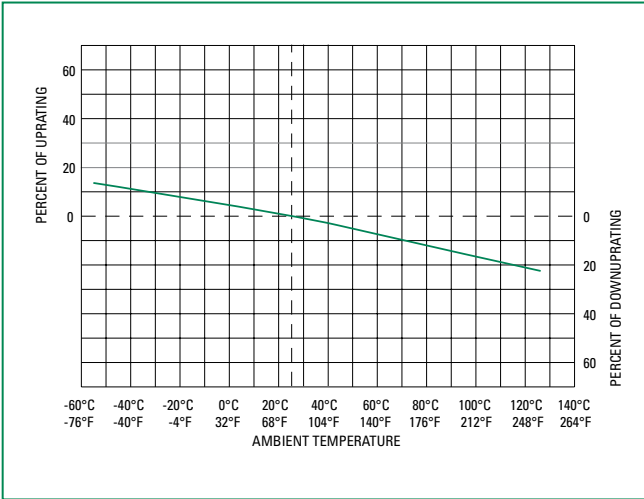

Note:  
 1. Rerating depicted in this curve is in addition to the standard derating of 25% for continuous operation.

**Average Time Current Curves**

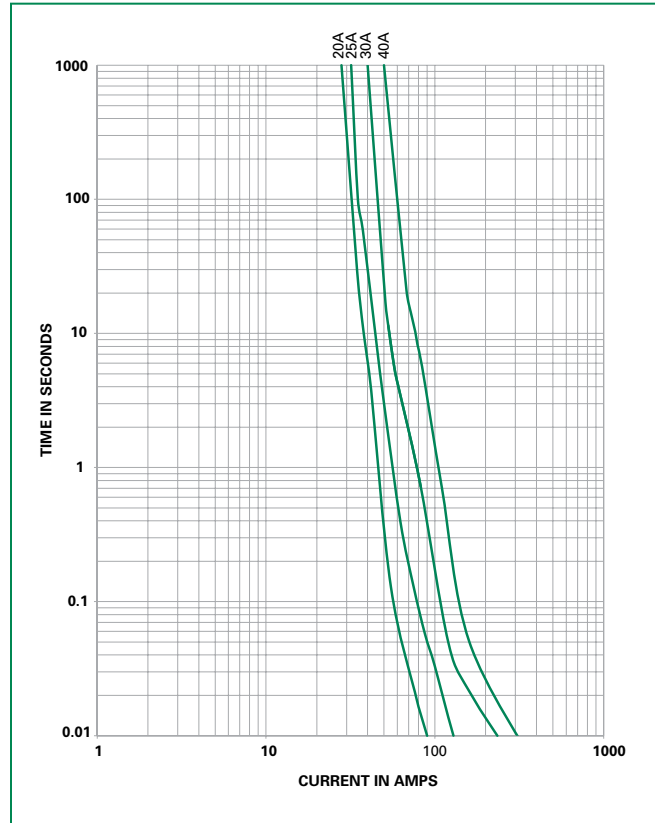

**Soldering Parameters – Reflow Soldering**

Reflow Condition		Pb – Free assembly
Pre Heat	- Temperature Min ( $T_{s(min)}$ )	150°C
	- Temperature Max ( $T_{s(max)}$ )	200°C
	- Time (Min to Max) ( $t_s$ )	60 – 180 secs
Average ramp up rate (Liquidus Temp ( $T_L$ ) to peak)		5°C/second max.
$T_{s(max)}$ to $T_L$ - Ramp-up Rate		5°C/second max.
Reflow	- Temperature ( $T_L$ ) (Liquidus)	217°C
	- Temperature ( $t_L$ )	60 – 150 seconds
Peak Temperature ( $T_p$ )		260 <sup>+0/-5</sup> °C
Time within 5°C of actual peak Temperature ( $t_p$ )		20 – 40 seconds
Ramp-down Rate		5°C/second max.
Time 25°C to peak Temperature ( $T_p$ )		8 minutes max.
Do not exceed		260°C

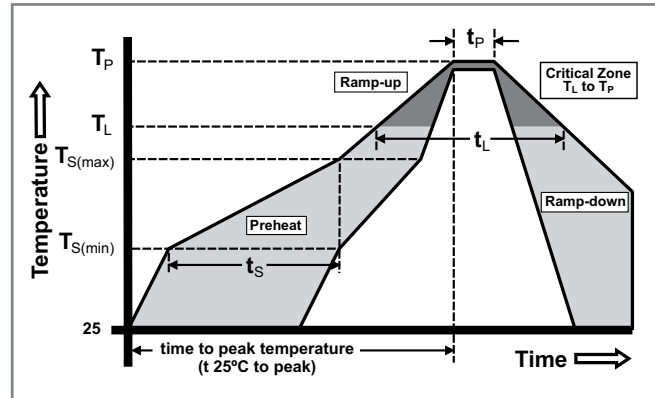

## Product Characteristics

<b>Materials</b>	Body: Ceramic Cap: Silver Plated Brass
<b>Product Marking</b>	Body: Brand Logo, Current Rating
<b>Insulation Resistance</b>	MIL-STD-202, method 302, Test Condition A (10,000 ohms, Minimum)
<b>Solderability</b>	MIL-STD-202, Method 208
<b>Resistance to Soldering Heat</b>	MIL-STD-202, Method 210, Test Condition B (10 sec at 260°C)
<b>PCB Recommendation for Thermal Management</b>	Min. copper layer thickness = 100µm Min. copper trace width = 20A, 30 10mm (20A, 30A) / 15mm (40A)  Alternate methods of thermal management may be used. In such cases, under normal operations, the maximum temperature of the fuse body should not exceed 90°C in a 25°C environment.

<b>Operating Temperature</b>	-55°C to 125°C with proper derating
<b>Thermal Shock</b>	MIL-STD-202, Method 107, Test Condition B (5 cycles -65°C to 125°C)
<b>Vibration</b>	MIL-STD-202, Method 201 (10-55 Hz)
<b>Moisture Sensitivity Level</b>	J-STD-020, Level 1
<b>Moisture Resistance</b>	MIL-STD-202 Method 106, High Humidity (90-98%RH), Heat (65°C)
<b>Salt Spray</b>	MIL-STD-202, Method 101, Test Condition B
<b>Mechanical Shock</b>	MIL-STD-202, Method 213, Test Condition I (100 G's peak for 6 milliseconds)

## Dimensions

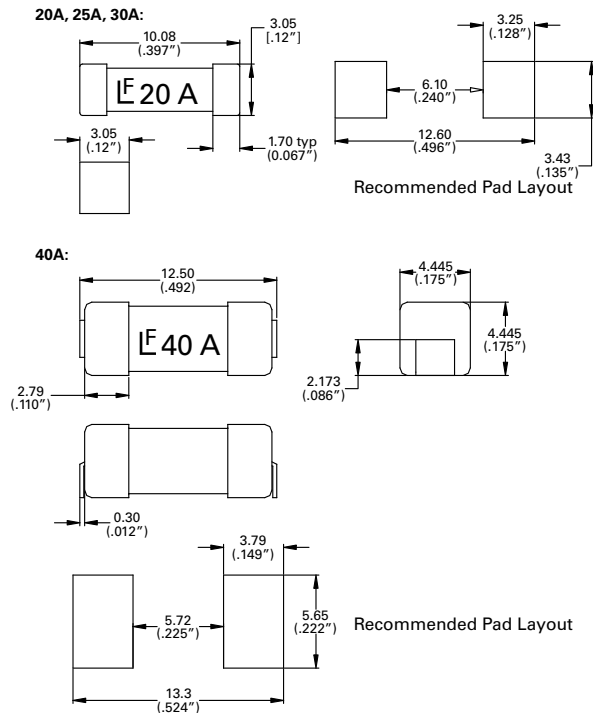

## Part Numbering System

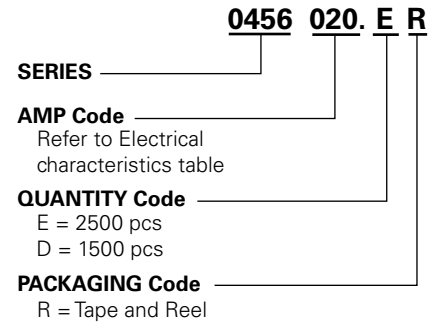

## Packaging

Rating	Packaging Option	Packaging Specification	Quantity	Quantity & Packaging Code
20A, 25A, 30A	24 mm Tape and Reel	EIA RS-481-2	2500	ER
40A	24 mm Tape and Reel	EIA RS-481-2 (IEC 286, part 3)	1500	DR