

## 3A, 45V - 60V Trench Schottky Rectifier

### FEATURES

- Patented Trench Schottky technology
- Excellent high temperature stability
- Low forward voltage
- Lower power loss/ high efficiency
- High forward surge capability
- Compliant to RoHS Directive 2011/65/EU and in accordance to WEEE 2002/96/EC
- Halogen-free according to IEC 61249-2-21

### APPLICATIONS

- Trench Schottky barrier rectifier is designed for high frequency miniature switched mode power supplies such as adapters, lighting and on-board DC/DC converters

### MECHANICAL DATA

- Case: SOD-123HE
- Molding compound meets UL 94V-0 flammability rating
- Part no. with suffix "H" means AEC-Q101 qualified
- Packing code with suffix "G" means green compound (halogen-free)
- Moisture sensitivity level: level 1, per J-STD-020
- Terminal: Matte tin plated leads, solderable per J-STD-002
- Meet JESD 201 class 2 whisker test
- Polarity: As marked
- Weight: 0.022g (approximately)

KEY PARAMETERS		
PARAMETER	VALUE	UNIT
$I_{F(AV)}$	3	A
$V_{RRM}$	45 - 60	V
$I_{FSM}$	80	A
$T_{J\ MAX}$	150	°C
Package	SOD-123HE	
Configuration	Single die	



**SOD-123HE**

ABSOLUTE MAXIMUM RATINGS ( $T_A = 25^\circ\text{C}$ unless otherwise noted)				
PARAMETER	SYMBOL	TSSE3U45	TSSE3U60	UNIT
Marking code on the device		E3U45	E3U60	
Maximum repetitive peak reverse voltage	$V_{RRM}$	45	60	V
Working Peak Reverse Voltage	$V_{RWM}$			V
DC Blocking Voltage	$V_{RM}$			V
Maximum RMS voltage	$V_{RMS}$	32	42	V
Forward current	$I_{F(AV)}$	3		A
Surge peak forward current, 8.3 ms single half sine-wave superimposed on rated load per diode	$I_{FSM}$	80		A
Junction temperature	$T_J$	-55 to +150		°C
Storage temperature	$T_{STG}$	-55 to +150		°C

<b>THERMAL PERFORMANCE</b>			
<b>PARAMETER</b>	<b>SYMBOL</b>	<b>LIMIT</b>	<b>UNIT</b>
Junction-to-lead thermal resistance per diode	$R_{\theta JL}$	23	°C/W
Junction-to-ambient thermal resistance per diode	$R_{\theta JA}$	70	°C/W

<b>ELECTRICAL SPECIFICATIONS</b> ( $T_A = 25^\circ\text{C}$ unless otherwise noted)						
<b>PARAMETER</b>		<b>CONDITIONS</b>	<b>SYMBOL</b>	<b>TYP</b>	<b>MAX</b>	<b>UNIT</b>
Forward voltage per diode <sup>(1)</sup>	TSSE3U45	$I_F = 1\text{A}, T_J = 25^\circ\text{C}$	$V_F$	0.33	-	V
		$I_F = 3\text{A}, T_J = 25^\circ\text{C}$		0.40	0.47	V
		$I_F = 1\text{A}, T_J = 125^\circ\text{C}$		0.24	-	V
		$I_F = 3\text{A}, T_J = 125^\circ\text{C}$		0.34	0.44	V
	TSSE3U60	$I_F = 1\text{A}, T_J = 25^\circ\text{C}$		0.39	-	V
		$I_F = 3\text{A}, T_J = 25^\circ\text{C}$		0.49	0.58	V
		$I_F = 1\text{A}, T_J = 125^\circ\text{C}$		0.28	-	V
		$I_F = 3\text{A}, T_J = 125^\circ\text{C}$		0.43	0.52	V
Reverse current @ rated $V_R$ per diode <sup>(2)</sup>	$T_J = 25^\circ\text{C}$		$I_R$	-	1	mA
	$T_J = 125^\circ\text{C}$			-	50	mA

**Notes:**

1. Pulse test with  $PW=0.3$  ms
2. Pulse test with  $PW=30$  ms

<b>ORDERING INFORMATION</b>					
<b>PART NO.</b>	<b>PART NO. SUFFIX</b>	<b>PACKING CODE</b>	<b>PACKING CODE SUFFIX</b>	<b>PACKAGE</b>	<b>PACKING</b>
TSSE3Uxx (Note 1, 2)	H	RV	G	SOD-123HE	3,000 / 7" Reel
		RQ		SOD-123HE	10,000 / 13" Reel

**Notes:**

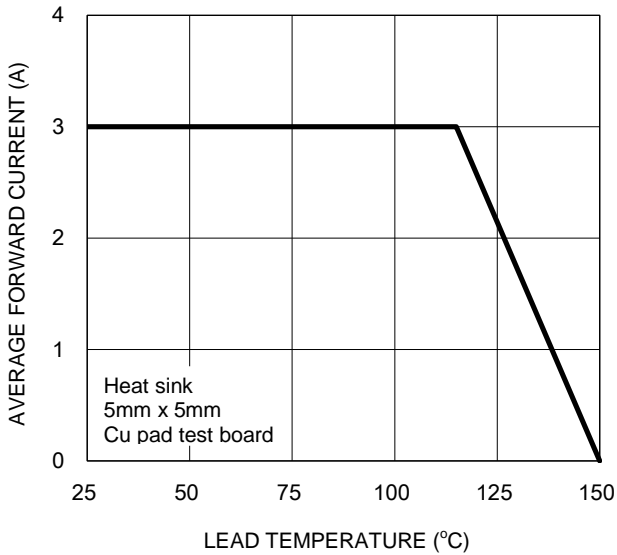
1. "x" defines voltage from 45V (TSSE3U45) to 60V (TSSE3U60)
2. Whole series with green compound (halogen-free)

<b>EXAMPLE P/N</b>					
<b>EXAMPLE P/N</b>	<b>PART NO.</b>	<b>PART NO. SUFFIX</b>	<b>PACKING CODE</b>	<b>PACKING CODE SUFFIX</b>	<b>DESCRIPTION</b>
TSSE3U45HRVG	TSSE3U45	H	RV	G	AEC-Q101 qualified Green compound

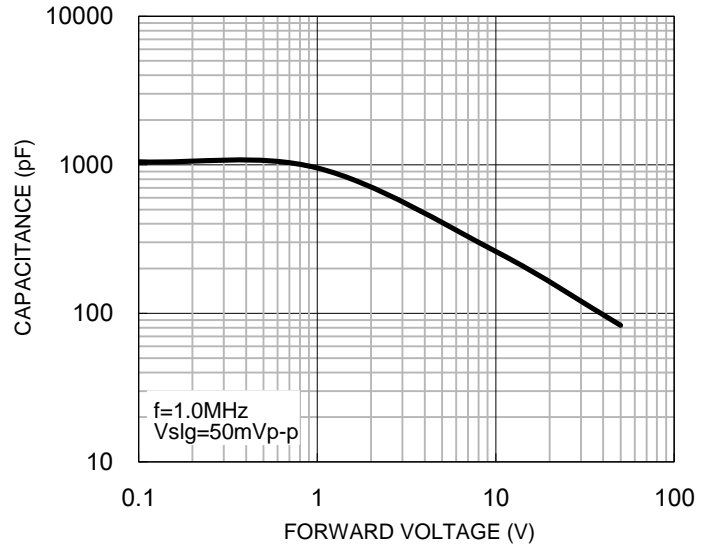
**CHARACTERISTICS CURVES**

( $T_A = 25^\circ\text{C}$  unless otherwise noted)

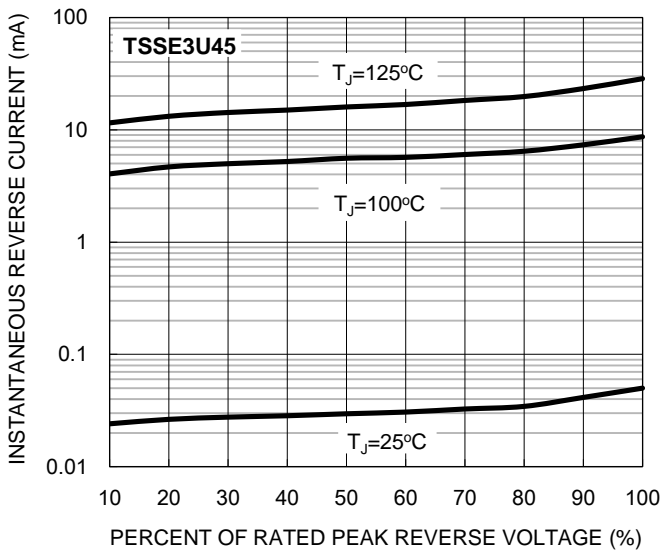
**Fig.1 Forward Current Derating Curve**



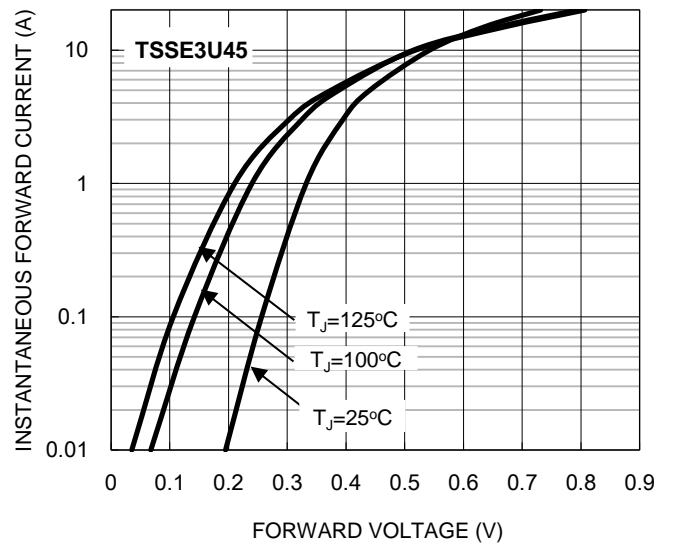
**Fig.2 Typical Junction Capacitance**



**Fig.3 Typical Reverse Characteristics**



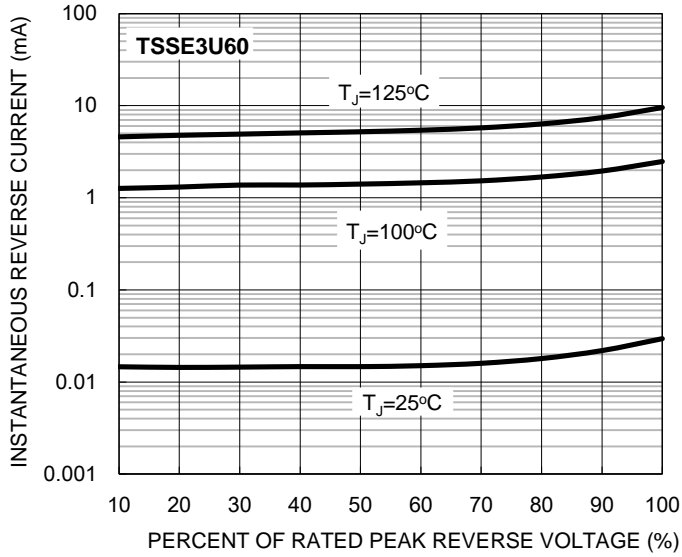
**Fig.4 Typical Forward Characteristics**



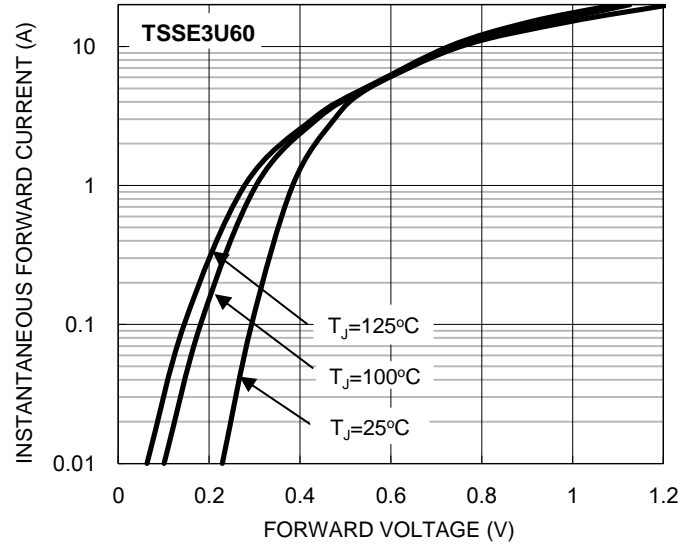
**CHARACTERISTICS CURVES**

( $T_A = 25^\circ\text{C}$  unless otherwise noted)

**Fig.5 Typical Reverse Characteristics**

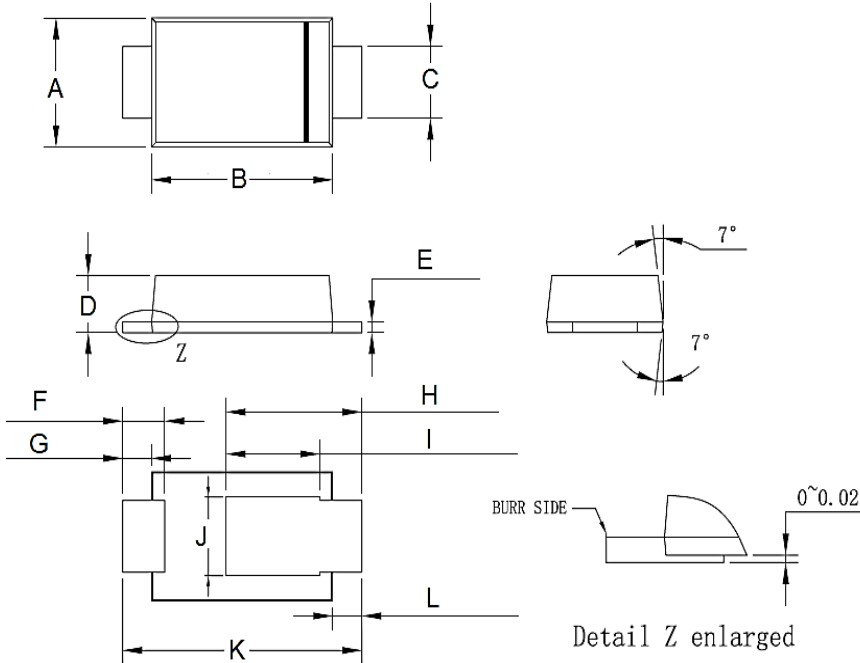


**Fig.6 Typical Forward Characteristics**



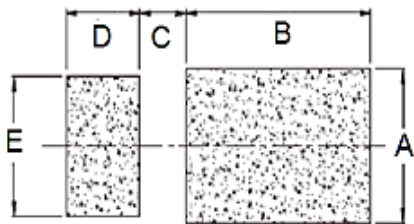
**PACKAGE OUTLINE DIMENSIONS**

**SOD-123HE**



DIM.	Unit (mm)		Unit (inch)	
	Min	Max	Min	Max
A	1.65	1.95	0.065	0.077
B	2.60	3.00	0.102	0.118
C	0.85	1.15	0.033	0.045
D	0.75	0.85	0.030	0.033
E	0.10	0.20	0.004	0.008
F	0.55	0.75	0.022	0.030
G	0.35	0.55	0.014	0.022
H	1.90	2.30	0.075	0.091
I	1.35	1.55	0.053	0.061
J	0.95	1.25	0.037	0.049
K	3.50	3.90	0.138	0.154
L	0.35	0.55	0.014	0.022

**SUGGESTED PAD LAYOUT**



Symbol	Unit (mm)	Unit (inch)
A	1.40	0.055
B	2.40	0.094
C	0.70	0.028
D	0.90	0.035
E	1.40	0.055

**MARKING DIAGRAM**



- P/N = Marking Code
- YW = Date Code
- F = Factory Code

## Notice

Specifications of the products displayed herein are subject to change without notice. TSC or anyone on its behalf, assumes no responsibility or liability for any errors or inaccuracies.

Information contained herein is intended to provide a product description only. No license, express or implied, to any intellectual property rights is granted by this document. Except as provided in TSC's terms and conditions of sale for such products, TSC assumes no liability whatsoever, and disclaims any express or implied warranty, relating to sale and/or use of TSC products including liability or warranties relating to fitness for a particular purpose, merchantability, or infringement of any patent, copyright, or other intellectual property right.

The products shown herein are not designed for use in medical, life-saving, or life-sustaining applications. Customers using or selling these products for use in such applications do so at their own risk and agree to fully indemnify TSC for any damages resulting from such improper use or sale.