

COMPACT PLCC SOCKETS

SERIES 540 • SURFACE MOUNT

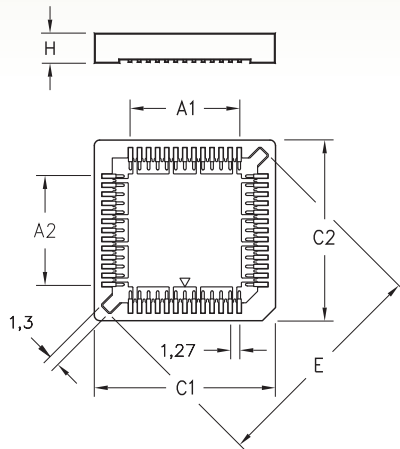

- Note: Not end stackable
- Designed for JEDEC type devices
- Open frame design in solder area improves results of IR soldering and facilitates visual inspection of solder pads
- Contacts are plated with 3,81µm tin
- The insulator is molded PPS (Ryton R-4)
- For Electrical, Mechanical and Environmental Data, see page 141 for details

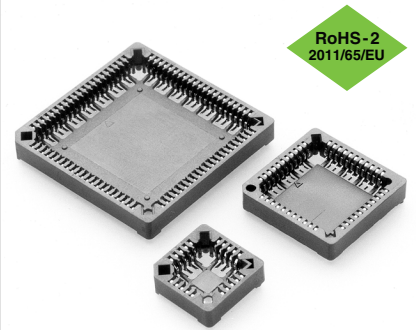

PCB LAYOUT FOR SURFACE MOUNT

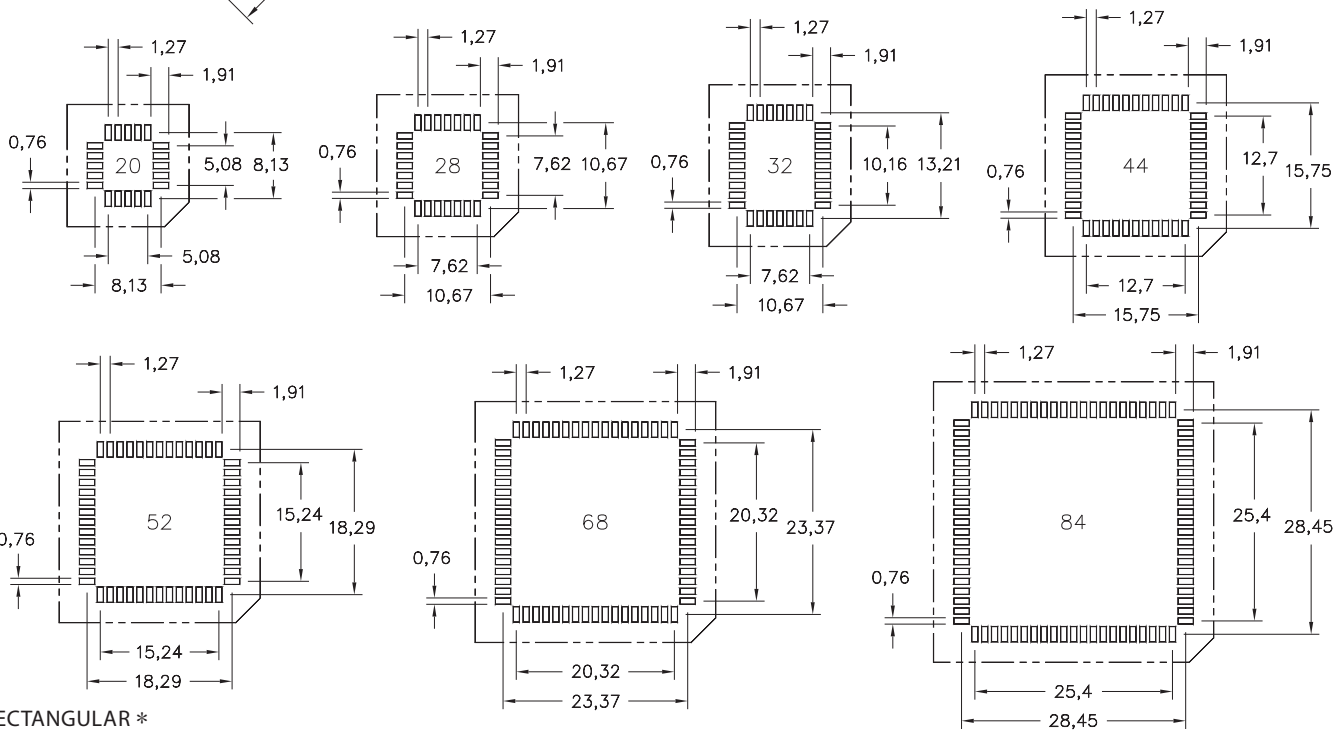

RECTANGULAR *

Number of Contacts	Ordering Information	- A1 -	- A2 -	- C1 -	- C2 -	- E -	- H -	Qty. per Tube	Tape Width mm	Qty. per Reel
20	540-44-020-17-40000X	5,08	5,08	14,86	14,86	16,69	4,57	34	24	490
28	540-44-028-17-40000X	7,62	7,62	17,4	17,4	20,29	4,57	29	32	400
32 *	540-44-032-17-40000X *	7,62	10,16	17,02	19,56	22,48	3,76	26	32	400
44	540-44-044-17-40000X	12,7	12,7	22,48	22,48	27,48	4,57	22	44	250
52	540-44-052-17-40000X	15,24	15,24	25,4	25,4	31,09	4,57	20	44	250
68	540-44-068-17-40000X	20,32	20,32	30,53	30,53	38,28	4,57	16	44	220
84	540-44-084-17-40000X	25,4	25,4	35,56	35,56	45,49	4,57	14	56	200

Packaging Codes: X = 0 (Tubes)
X = 4 (Tape & Reel)

