

1 2 3 4 5 6

A

B

C

D

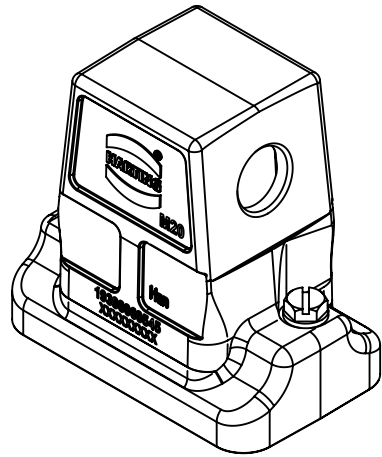

X (2:1)

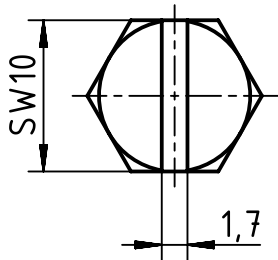

Panel cut out

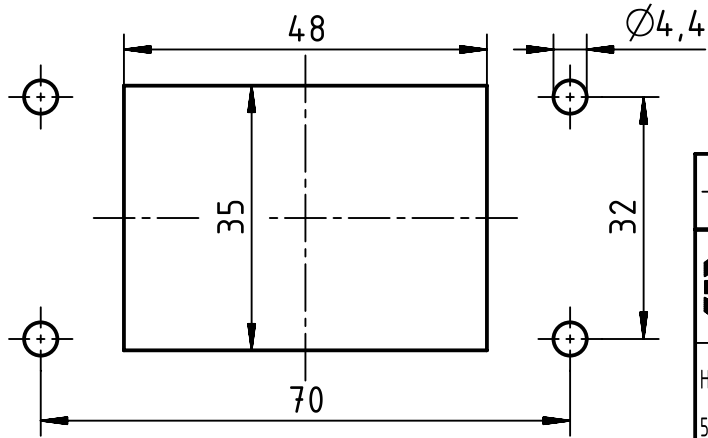
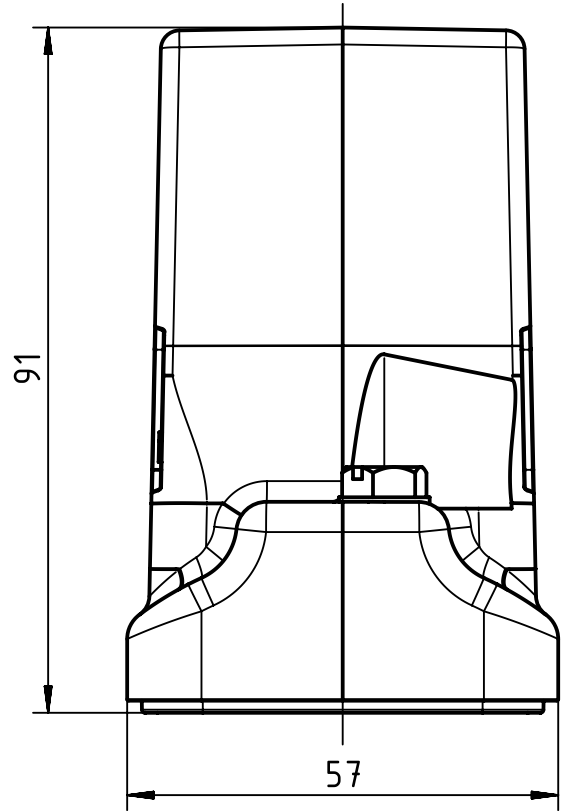
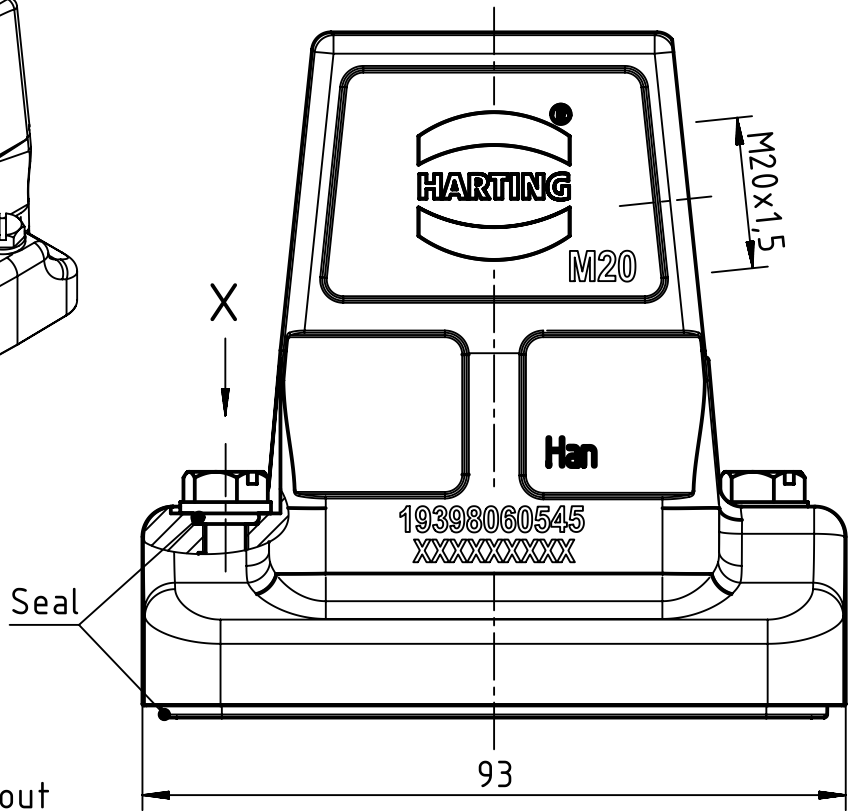

	All Dimensions in mm Original Size DIN A4		Scale 1:1	Free size tol.		Ref.	
	All rights reserved Department EL PD - CN		Created by LONGL	Inspected by WENE	Standardisation SCHMIDTM	Date 2017-03-20	State Final Release
HARTING (Zhuhai) Manufacturing Co., Ltd. 519085 Zhuhai, China			Title Han 6HP Direct/EMV-HSE-M20			Doc-Key / ECM-Nr. 100665282/UGD/003/C 500000116964	
			Type TB	Number 19 39 806 0545		Rev. C	Page 1/1