

LISA2-WW-CLIP

~45° wide beam optimized for CREE XP-E. 6.8 mm high variant with clip installation.

TECHNICAL SPECIFICATIONS:

Dimensions	Ø 9.9 mm
Height	6.8 mm
Fastening	glue, clips
Colour	black
Box size	
Box weight	1.4 kg
Quantity in Box	2000 pcs
ROHS compliant	yes ⓘ



MATERIAL SPECIFICATIONS:

Component	Type	Material	Colour
LISA2-WW	Lens	PMMA	clear
LISA2-HLD-CLIP16-XP	Holder	PC	black

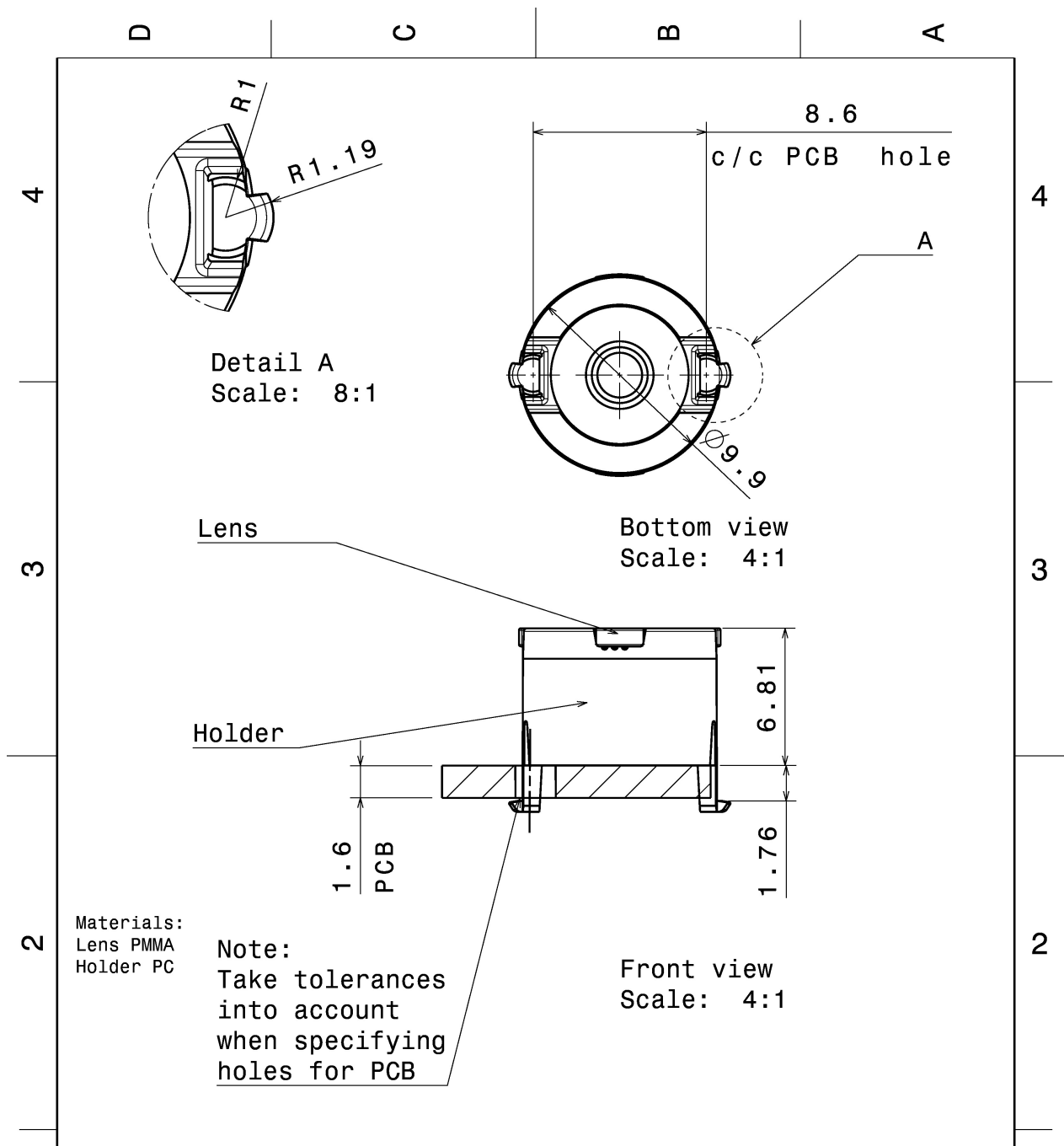

Materials:
Lens PMMA
Holder PC

Note:
Take tolerances into account when specifying holes for PCB

This drawing is our property. It can't be reproduced or communicated without our written agreement.



Ledil Oy
Salorankatu 10
FIN-24240 SALO
Finland

DRAWN BY pl		DATE 20.06.2012	DRAWING TITLE Datasheet Lisa2-clip16-XT series Assy		
CHECKED BY sn	DATE 20.7.2011	SIZE A4	DRAWING NUMBER		REV 1
DESIGNED BY pl	DATE 20.06.2012	SCALE 4:1	WEIGHT (g)	SHEET 1/1	

PHOTOMETRIC DATA (MEASURED):



LED XP-E2
FWHM 43.0°
Efficiency 88 %
Peak intensity 1.350 cd/lm
Required components:

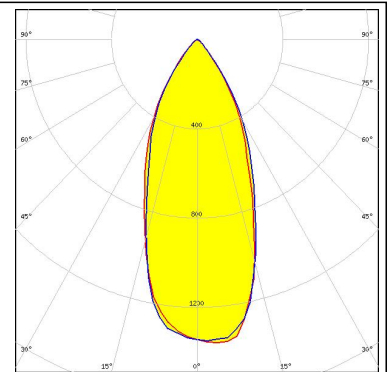
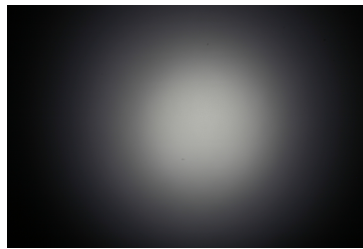

LED XP-G2
FWHM 47.0°
Efficiency 88 %
Peak intensity 1.200 cd/lm
Required components:

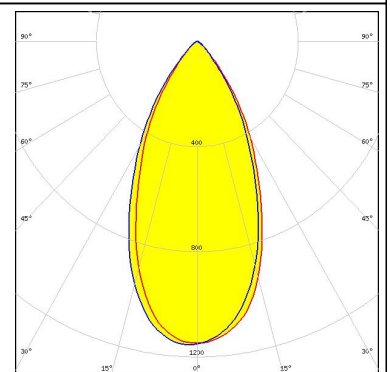

LED XP-G3
FWHM 42.0°
Efficiency 84 %
Peak intensity 1.500 cd/lm
Required components:

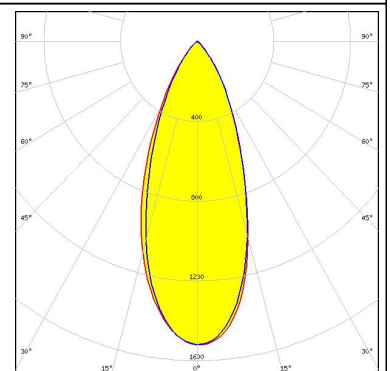
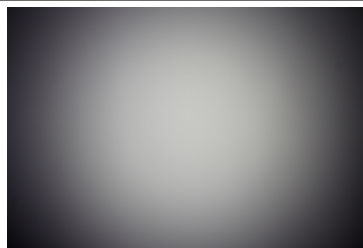

LED XT-E
FWHM 47.0°
Efficiency 84 %
Peak intensity 1.100 cd/lm
Required components:

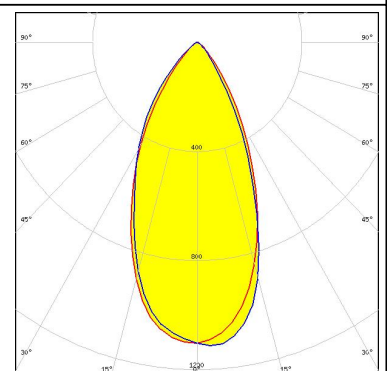

PHOTOMETRIC DATA (MEASURED):



LED NCSxx19B
 FWHM 41.0°
 Efficiency 86 %
 Peak intensity 1.500 cd/lm
 Required components:

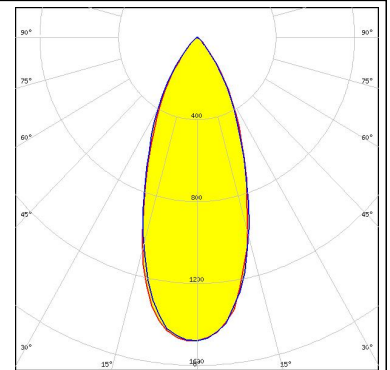

LED Oslon Square EC
 FWHM 46.0°
 Efficiency 84 %
 Peak intensity 1.600 cd/lm
 Required components:

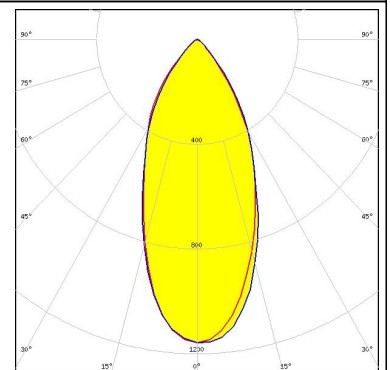
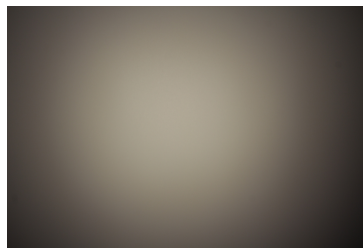

LED SFH 4715S
 FWHM 36.0°
 Efficiency 0 %
 Peak intensity 0.000 cd/lm
 Required components:

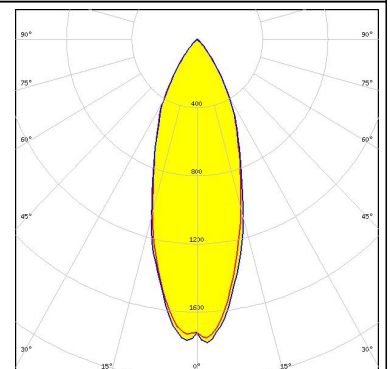

LED SFH 4725S
 FWHM 38.0°
 Efficiency %
 Peak intensity cd/lm
 Required components:

PHOTOMETRIC DATA (MEASURED):

SAMSUNG

LED LH351B
FWHM 67.0°
Efficiency 88 %
Peak intensity 0.890 cd/lm
Required components:

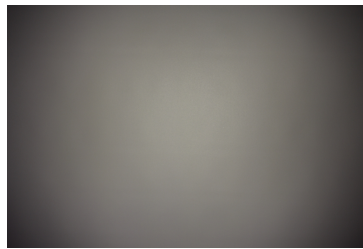

SAMSUNG

LED LH351Z
FWHM 60.0°
Efficiency 90 %
Peak intensity 0.950 cd/lm
Required components:

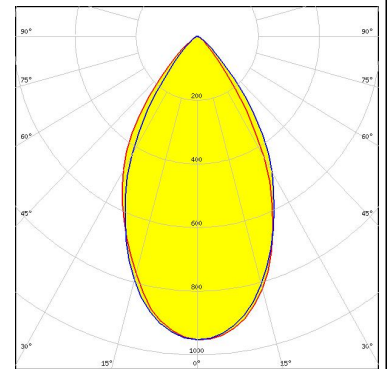
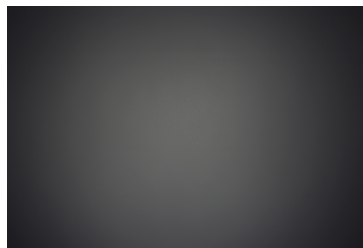

PHOTOMETRIC DATA (SIMULATED):

LUMILEDS

LED LUXEON IR Compact
FWHM 51.0°
Efficiency 84 %
Peak intensity 0.000 cd/lm
Required components:

LUMILEDS

LED LUXEON IR Domed 150
FWHM 60.0°
Efficiency 90 %
Peak intensity 0.000 cd/lm
Required components:

LUMILEDS

LED LUXEON Q
FWHM 54.0°
Efficiency 84 %
Peak intensity 1.000 cd/lm
Required components:

OSRAM Opto Semiconductors

LED SFH 4770S
FWHM 35.0°
Efficiency 91 %
Peak intensity cd/lm
Required components:

PHOTOMETRIC DATA (SIMULATED):

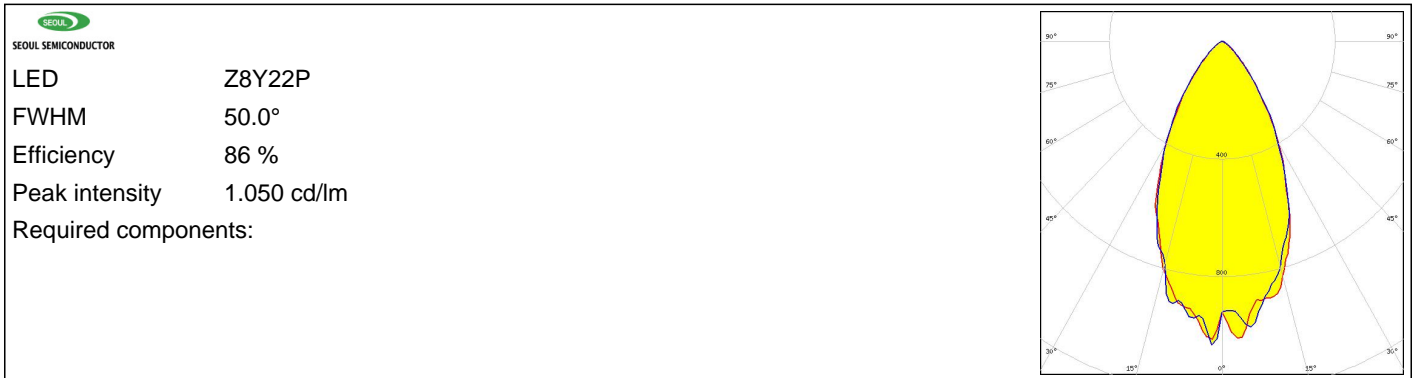

GENERAL INFORMATION:

NOTE: The typical beam angle will be changed by different color, chip size and chip position tolerance. The typical total beam angle is the full angle measured where the luminous intensity is half of the peak value.

MATERIALS:

As part of our continuous research and improvement processes, and to ensure the best possible quality and availability of our products, LEDiL reserves the right to change material grades without notice.

PRODUCT DATA USER AGREEMENT AND DISCLAIMER:

The measured data in the provided downloadable LEDiL Product Datasheets and Mechanical 2D-Drawings is rounded and provided as reference for planning. LEDiL Oy's optical specifications have been verified by conducting performance testing of the products in accordance with the company's quality system. The reported data are averaged results of multiple measurements with typical variation. LEDiL Oy reserves the right to without prior notification make changes and improvements to its products.

LEDiL Oy assumes neither warranty, nor guarantee nor any other liability of any kind for the contents and correctness of the provided data. The provided data has been generated with highest diligence but the provided data may in reality not represent the complete possible variation range of all intrinsic parameters. Therefore, in certain cases a deviation from the provided data could occur.

LEDiL Oy reserves the right to undertake technical changes of its products without further notification which could lead to changes in the provided data. LEDiL Oy assumes no liability of any kind for the possible deviation from any provided data or any other damage resulting from the usage of the provided data.

The user agrees to this disclaimer and user agreement with the download or usage of the provided files.

LEDiL Oy

Joensuunkatu 13
FI-24240 SALO
Finland

LEDiL Inc.

228 West Page Street
Suite D
Sycamore IL 60178
USA

Local sales and technical support

[www.ledil.com/
where_to_buy](http://www.ledil.com/where_to_buy)

Shipping locations

Salo, Finland
Hong Kong, China

Distribution Partners

[www.ledil.com/
where_to_buy](http://www.ledil.com/where_to_buy)