

# SNA series (1A,3A)

SNA -03 -223 -□

① ② ③ ④

- ① Model Name
- ② Rated Current
- ③ Line to ground capacitor code: See table 1.1.

table 1.1 Line to ground capacitor code

Code	Line to ground capacitor (nominal value)
000	Not Provided
223	22000pF

- ④ Options
- D: DIN rail installation type

\* The dimensions change when the option is set. Refer to External view.

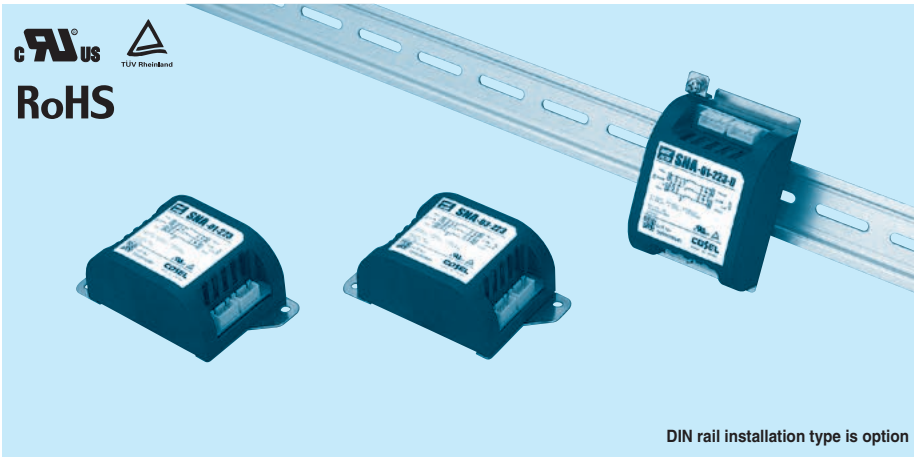

DIN rail installation type is option



## Features of SNA series (1A and 3A)

### Ripple noise attenuation type for switch mode power supplies(DC)

- ±50 VDC
- Best filter for switch mode power supplies of analog circuits (ex. power supply filter for an operational amplifier)

### Specifications

No.	Items	SNA-01-223	SNA-03-223
		Interface: Connector	
1	Rated Voltage DC[V]	±50 (+Vin - COM-in, -Vin - COM-in)	
2	Rated Current DC[A]	1	3
3	Test Voltage (Terminal-Mounting Plate)	500 VAC (Cutoff Current = 100mA), 1minute at room temperature and humidity	
4	Isolation Resistance (Terminal-Mounting Plate)	500 VDC 50MΩ min at room temperature and humidity	
5	DC resistance	190mΩ max	90mΩ max
6	Operating temperature	-40 to +71°C (Refer to Derating Curve)	
7	Operating humidity	20 to 95%RH (Non condensing)	
8	Storage temperature/humidity	-40 to +75°C/20 to 95%RH (Non condensing)	
9	Vibration	10 to 55Hz, 19.6m/s <sup>2</sup> (2G), 3min. Period, 1hour each X, Y and Z axis	
10	Impact	196.1m/s <sup>2</sup> (20G), 11ms Once each X, Y and Z axis	
11	Safety agency approvals	UL60950-1, C-UL (CSA60950-1), EN60950-1	
12	Case size (without projection) /Weight	52 X 35 X 93 mm [2.05 X 1.38 X 3.66 inches] (W X H X D) /130g max (Option : -D refer to external view)	

### Circuit Diagram

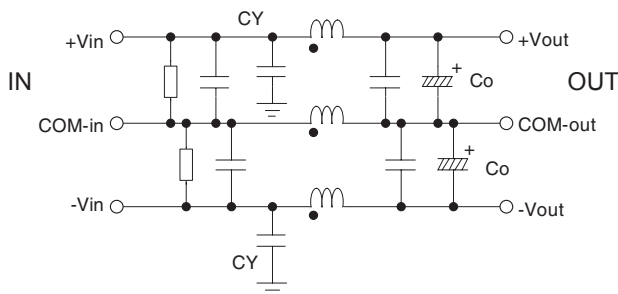

CY : Line to ground capacitor Co : Electrolytic capacitor : Mounting Plate

■ Expected life : 10 years

### Derating Curve

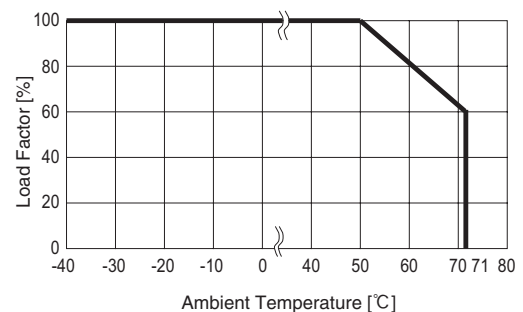

## External view

### Standard Type

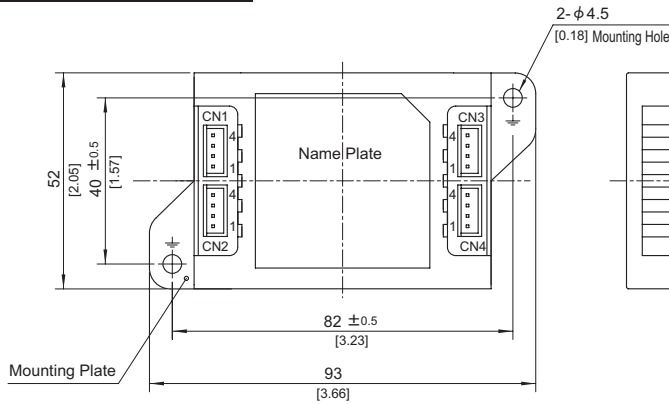

CN1	
Pin No.	Function
1,2	COM-in
3,4	+Vin

CN3	
Pin No.	Function
1,2	COM-out
3,4	+Vout

CN2	
Pin No.	Function
1,2	-Vin
3,4	COM-in

CN4	
Pin No.	Function
1,2	-Vout
3,4	COM-out

I/O Connector	Mating connector	Terminal
CN1-CN4	B4B-XH-AM	XHP-4
		Reel: SXH-001T-P0.6
		Bulk: BXH-001T-P0.6

(Mfr.: J.S.T)

Option harness : Refer to Instruction Manual 4

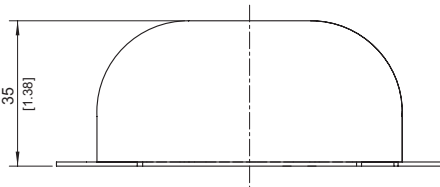

※ Tolerance : ±1 [±0.04]

※ Weight : 130g max

※ PCB Material /thickness : CEM3 /1.6mm [0.06 inches]

※ Mounting plate : Iron (surface finishing : nickel plating) t=1.0 [0.04]

※ Case : PBT

※ Dimensions in mm, [ ]=inches

※ Keeping drawing current per pin below 2A for CN1 to CN4

### DIN rail installation Type

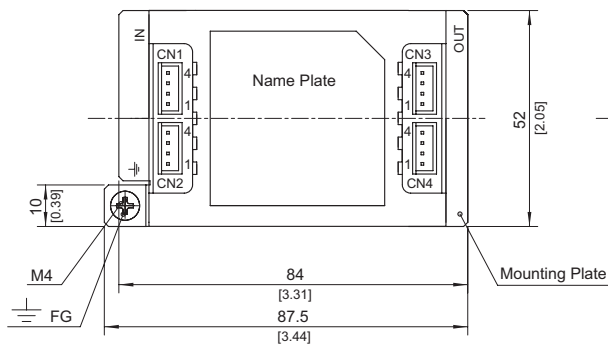

CN1	
Pin No.	Function
1,2	COM-in
3,4	+Vin

CN3	
Pin No.	Function
1,2	COM-out
3,4	+Vout

CN2	
Pin No.	Function
1,2	-Vin
3,4	COM-in

CN4	
Pin No.	Function
1,2	-Vout
3,4	COM-out

I/O Connector	Mating connector	Terminal
CN1-CN4	B4B-XH-AM	XHP-4
		Reel: SXH-001T-P0.6
		Bulk: BXH-001T-P0.6

(Mfr.: J.S.T)

Option harness : Refer to Instruction Manual 4

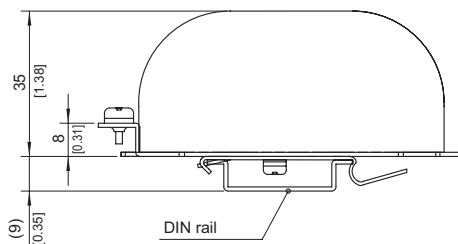

※ Tolerance : ±1 [±0.04]

※ Weight : 140g max

※ PCB Material /thickness : CEM3 /1.6mm [0.06 inches]

※ Mounting plate : Iron (surface finishing : nickel plating) t=1.0 [0.04]

※ Case : PBT

※ Dimensions in mm, [ ]=inches

※ Keeping drawing current per pin below 2A for CN1 to CN4

### ■Note when installing the EMI/EMC Filter on a DIN rail.

When the EMI/EMC Filter is grounded through the DIN rail, the proper noise attenuation may not be achieved.

Be sure to connect the FG terminal of the EMI/EMC Filter body to the earth.

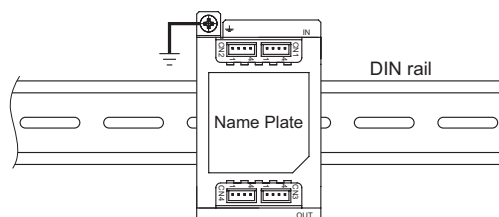

# SNA series (6A)

SNA -06 -223 -□

① ② ③ ④

- ① Model Name
- ② Rated Current
- ③ Line to ground capacitor code: See table 1.1.

table 1.1 Line to ground capacitor code

Code	Line to ground capacitor (nominal value)
000	Not Provided
223	22000pF

- ④ Options
- D :DIN rail installation type
- T :Terminal block type
- DT :Terminal block and DIN rail type

\* The dimensions change when the option is set. Refer to External view.

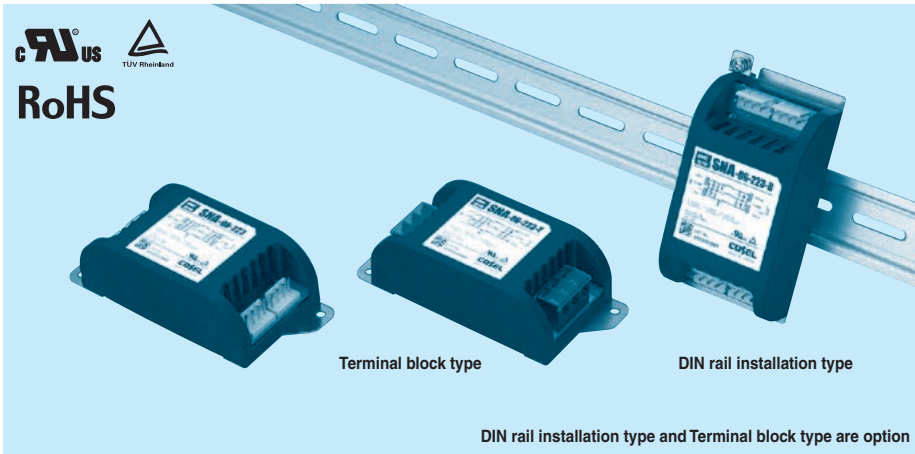

## Features of SNA series (6A)

### Ripple noise attenuation type for switch mode power supplies(DC)

- ±50 VDC
- Best filter for switch mode power supplies of analog circuits (ex. power supply filter for an operational amplifier)

### Specifications

No.	Items	SNA-06-223
		Interface:Connector
1	Rated Voltage DC[V]	±50 (+Vin - COM-in, -Vin - COM-in)
2	Rated Current DC[A]	6
3	Test Voltage (Terminal-Mounting Plate)	500 VAC (Cutoff Current = 100mA), 1minute at room temperature and humidity
4	Isolation Resistance (Terminal-Mounting Plate)	500 VDC 50MΩ min at room temperature and humidity
5	DC resistance	50mΩ max
6	Operating temperature	-40 to +71°C (Refer to Derating Curve)
7	Operating humidity	20 to 95%RH (Non condensing)
8	Storage temperature/humidity	-40 to +75°C/20 to 95%RH (Non condensing)
9	Vibration	10 to 55Hz, 19.6m/s <sup>2</sup> (2G), 3min. Period, 1hour each X, Y and Z axis
10	Impact	196.1m/s <sup>2</sup> (20G), 11ms Once each X, Y and Z axis
11	Safety agency approvals	UL60950-1, C-UL (CSA60950-1), EN60950-1
12	Case size (without projection) /Weight	52 X 35 X 117 mm [2.05 X 1.38 X 4.61 inches] (W X H X D) /150g max (Option : -D, -T, -DT refer to external view)

### Circuit Diagram

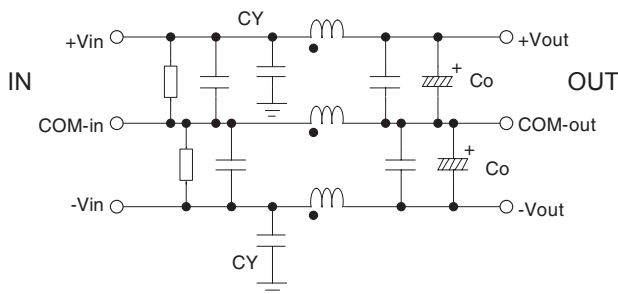

CY : Line to ground capacitor Co : Electrolytic capacitor : Mounting Plate

■ Expected life : 10 years

### Derating Curve

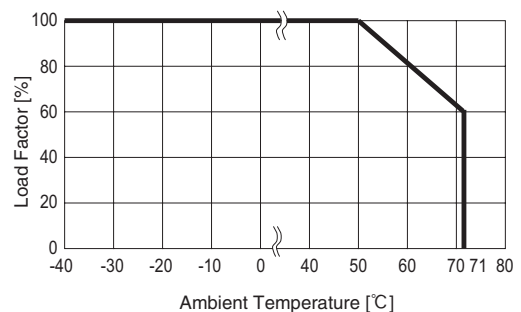

## External view

### Standard Type

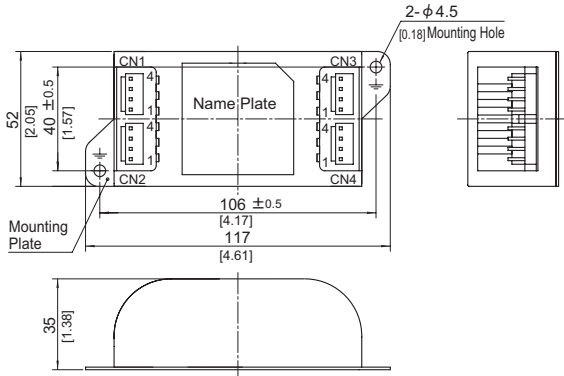

- ※ Tolerance :  $\pm 1$  [ $\pm 0.04$ ]
- ※ Weight : 150g max
- ※ PCB Material /thickness : CEM3 /1.6mm [0.06 inches]
- ※ Mounting plate : Iron (surface finishing : nickel plating)  $t=1.0$  [0.04]
- ※ Case : PBT
- ※ Dimensions in mm, [ ]=inches
- ※ Keeping drawing current per pin below 5A for CN1 to CN4

CN1		CN3	
Pin No.	Function	Pin No.	Function
1,2	COM-in	1,2	COM-out
3,4	+Vin	3,4	+Vout

CN2		CN4	
Pin No.	Function	Pin No.	Function
1,2	-Vin	1,2	-Vout
3,4	COM-in	3,4	COM-out

I/O Connector	Mating connector	Terminal
CN1-CN4	B4P-VH VHR-4N	Reel:SVH-21T-P1.1 Bulk:BVH-21T-P1.1

(Mfr:J.S.T)

Option harness : Refer to Instruction Manual 4

### Terminal block Type

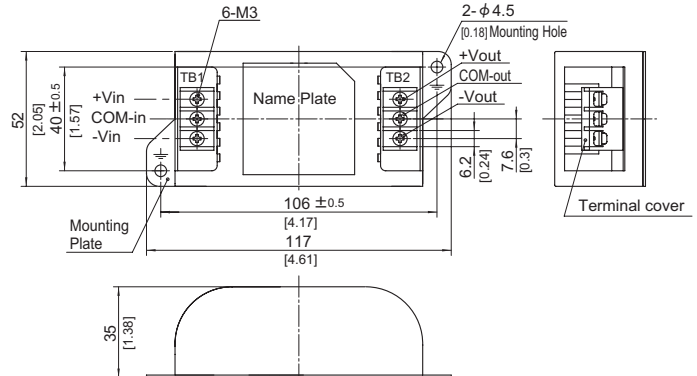

- ※ Tolerance :  $\pm 1$  [ $\pm 0.04$ ]
- ※ Weight : 160g max
- ※ PCB Material /thickness : CEM3 /1.6mm [0.06 inches]
- ※ Mounting plate : Iron (surface finishing : nickel plating)  $t=1.0$  [0.04]
- ※ Case : PBT
- ※ Dimensions in mm, [ ]=inches
- ※ Terminal block screw tightening torque M3:0.8N · m (8.5kgf · cm) max

### DIN rail installation Type

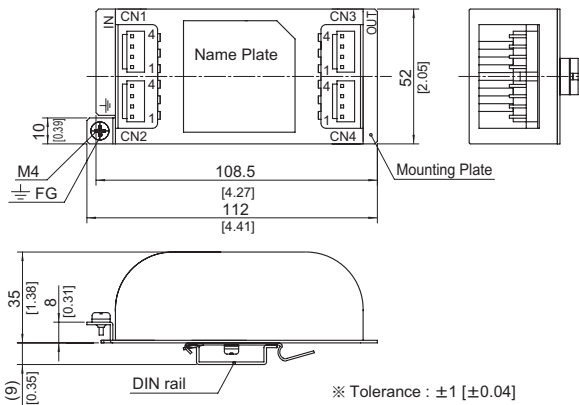

- ※ Tolerance :  $\pm 1$  [ $\pm 0.04$ ]
- ※ Weight : 160g max
- ※ PCB Material /thickness : CEM3 / 1.6mm [0.06 inches]
- ※ Mounting plate : Iron (surface finishing : nickel plating)  $t=1.0$  [0.04]
- ※ Case : PBT
- ※ Dimensions in mm, [ ]=inches
- ※ Keeping drawing current per pin below 5A for CN1 to CN4

CN1		CN3	
Pin No.	Function	Pin No.	Function
1,2	COM-in	1,2	COM-out
3,4	+Vin	3,4	+Vout

CN2		CN4	
Pin No.	Function	Pin No.	Function
1,2	-Vin	1,2	-Vout
3,4	COM-in	3,4	COM-out

I/O Connector	Mating connector	Terminal
CN1-CN4	B4P-VH VHR-4N	Reel:SVH-21T-P1.1 Bulk:BVH-21T-P1.1

(Mfr:J.S.T)

Option harness : Refer to Instruction Manual 4

### Terminal block type+DIN rail installation Type

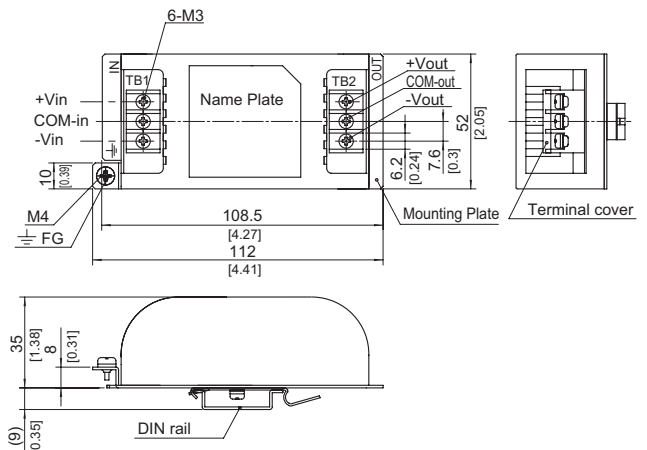

- ※ Tolerance :  $\pm 1$  [ $\pm 0.04$ ]
- ※ Weight : 170g max
- ※ PCB Material /thickness : CEM3 /1.6mm [0.06 inches]
- ※ Mounting plate : Iron (surface finishing : nickel plating)  $t=1.0$  [0.04]
- ※ Case : PBT
- ※ Dimensions in mm, [ ]=inches
- ※ Terminal block screw tightening torque M3:0.8N · m (8.5kgf · cm) max

## ■Note when installing the EMI/EMC Filter on a DIN rail.

When the EMI/EMC Filter is grounded through the DIN rail, the proper noise attenuation may not be achieved.

Be sure to connect the FG terminal of the EMI/EMC Filter body to the earth.

