

Features

- High voltage capability
- High speed

Applications

- Home appliance
- Lighting

Description

This device is a very fast IGBT developed using advanced PowerMESH™ technology. This process guarantees an excellent trade-off between switching performance and low on-state behavior. This device is well-suited for resonant or soft-switching applications.

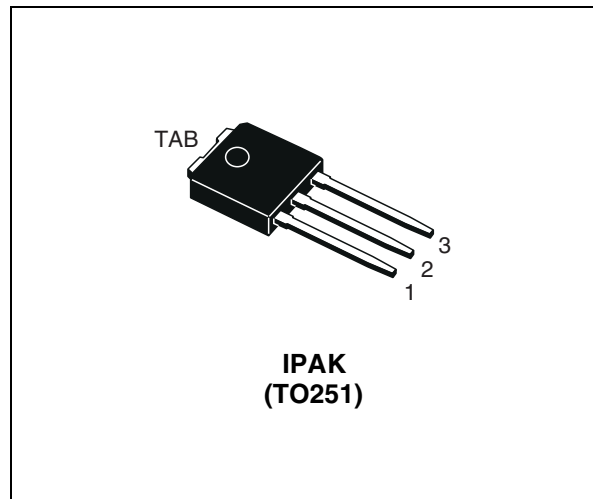

Figure 1. Internal schematic diagram

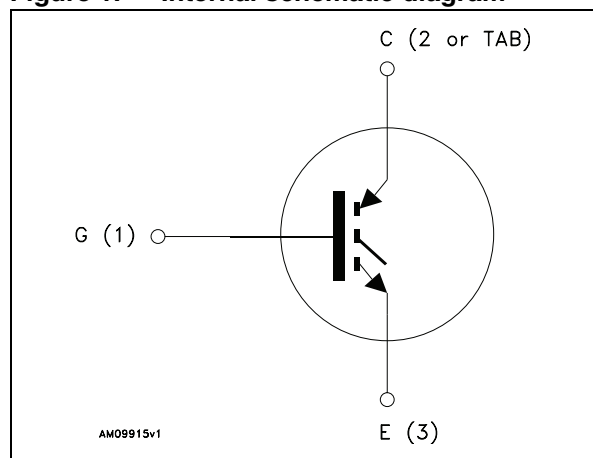

Table 1. Device summary

Order code	Marking	Package	Packaging
STGD3NC120H-1	GD3NC120H	IPAK (TO251)	Tube

Contents

1	Electrical ratings	3
2	Electrical characteristics	4
	2.1 Electrical characteristics (curves)	6
3	Test circuit	9
4	Package mechanical data	10
5	Revision history	12

1 Electrical ratings

Table 2. Absolute maximum ratings

Symbol	Parameter	Value	Unit
V_{CES}	Collector-emitter voltage ($V_{GE} = 0$)	1200	V
$I_C^{(1)}$	Continuous collector current at $T_C = 25\text{ °C}$	16	A
$I_C^{(1)}$	Continuous collector current at $T_C = 100\text{ °C}$	9	A
$I_{CL}^{(2)}$	Turn-off latching current	14	A
$I_{CP}^{(3)}$	Pulsed collector current	20	A
V_{GE}	Gate-emitter voltage	± 20	V
P_{TOT}	Total dissipation at $T_C = 25\text{ °C}$	105	W
T_J	Operating junction temperature	-55 to 150	°C

1. Calculated according to the iterative formula:

$$I_C(T_C) = \frac{T_{j(max)} - T_C}{R_{thj-c} \times V_{CE(sat)(max)}(T_{j(max)}, I_C(T_C))}$$

2. $V_{clamp} = 80\% V_{CES}$, $T_j = 150\text{ °C}$, $R_G = 10\ \Omega$, $V_{GE} = 15\text{ V}$
 3. Pulse width limited by maximum junction temperature and turn-off within RBSOA

Table 3. Thermal data

Symbol	Parameter	Value	Unit
R_{thJC}	Thermal resistance junction-case IGBT	1.2	°C/W
R_{thJA}	Thermal resistance junction-ambient	100	°C/W

2 Electrical characteristics

T_J = 25 °C unless otherwise specified.

Table 4. Static electrical characteristics

Symbol	Parameter	Test conditions	Min.	Typ.	Max.	Unit
V _{(BR)CES}	Collector-emitter breakdown voltage (V _{GE} = 0)	I _C = 1 mA	1200			V
V _{CE(sat)}	Collector-emitter saturation voltage	V _{GE} = 15 V, I _C = 3 A V _{GE} = 15 V, I _C = 3 A, T _J =125 °C		2.3 2.2	2.8	V V
V _{GE(th)}	Gate threshold voltage	V _{CE} = V _{GE} , I _C = 250 μA	2		5	V
I _{CES}	Collector cut-off current (V _{GE} = 0)	V _{CE} = 1200 V V _{CE} = 1200 V, T _J =125 °C			50 1	μA mA
I _{GES}	Gate-emitter leakage current (V _{CE} = 0)	V _{GE} = ± 20 V			± 100	nA
g _{fs} ⁽¹⁾	Forward transconductance	V _{CE} = 25 V, I _C = 3 A		4		S

1. Pulse duration: 300 μs, duty cycle 1.5%

Table 5. Dynamic

Symbol	Parameter	Test conditions	Min.	Typ.	Max.	Unit
C _{ies} C _{oes} C _{res}	Input capacitance Output capacitance Reverse transfer capacitance	V _{CE} = 25 V, f = 1 MHz, V _{GE} =0	-	470 45 6	-	pF pF pF
Q _g Q _{ge} Q _{gc}	Total gate charge Gate-emitter charge Gate-collector charge	V _{CE} = 960 V, I _C = 3 A, V _{GE} =15 V	-	24 3 10	-	nC nC nC

Table 6. Switching on/off (inductive load)

Symbol	Parameter	Test conditions	Min.	Typ.	Max.	Unit
$t_{d(on)}$	Turn-on delay time	$V_{CC} = 800\text{ V}, I_C = 3\text{ A}$	-	15	-	ns
t_r	Current rise time	$R_G = 10\ \Omega, V_{GE} = 15\text{ V},$ (see Figure 18)	-	3.5	-	ns
$(di/dt)_{on}$	Turn-on current slope			880		A/ μ s
$t_{d(on)}$	Turn-on delay time	$V_{CC} = 800\text{ V}, I_C = 3\text{ A}$	-	14.5	-	ns
t_r	Current rise time	$R_G = 10\ \Omega, V_{GE} = 15\text{ V},$ $T_J = 125\text{ }^\circ\text{C}$ (see Figure 18)	-	4	-	ns
$(di/dt)_{on}$	Turn-on current slope			770		A/ μ s
$t_r(V_{off})$	Off voltage rise time	$V_{CC} = 800\text{ V}, I_C = 3\text{ A}$	-	72	-	ns
$t_{d(off)}$	Turn-off delay time	$R_G = 10\ \Omega, V_{GE} = 15\text{ V},$ (see Figure 18)	-	118	-	ns
t_f	Current fall time			250		ns
$t_r(V_{off})$	Off voltage rise time	$V_{CC} = 800\text{ V}, I_C = 3\text{ A}$	-	132	-	ns
$t_{d(off)}$	Turn-off delay time	$R_G = 10\ \Omega, V_{GE} = 15\text{ V},$ $T_J = 125\text{ }^\circ\text{C}$ (see Figure 18)	-	210	-	ns
t_f	Current fall time			470		ns

Table 7. Switching energy (inductive load)

Symbol	Parameter	Test conditions	Min.	Typ.	Max.	Unit
$E_{on}^{(1)}$	Turn-on switching losses	$V_{CC} = 800\text{ V}, I_C = 3\text{ A}$	-	236	-	μ J
$E_{off}^{(2)}$	Turn-off switching losses	$R_G = 10\ \Omega, V_{GE} = 15\text{ V},$ (see Figure 18)	-	290	-	μ J
E_{ts}	Total switching losses			526		μ J
$E_{on}^{(1)}$	Turn-on switching losses	$V_{CC} = 800\text{ V}, I_C = 3\text{ A}$	-	360	-	μ J
$E_{off}^{(2)}$	Turn-off switching losses	$R_G = 10\ \Omega, V_{GE} = 15\text{ V},$ $T_J = 125\text{ }^\circ\text{C}$ (see Figure 18)	-	620	-	μ J
E_{ts}	Total switching losses			980		μ J

1. E_{on} is the turn-on losses when a typical diode is used in the test circuit in figure 2. If the IGBT is offered in a package with a co-pack diode, the co-pack diode is used as external diode. IGBTs & Diode are at the same temperature (25 °C and 125 °C)
2. Turn-off losses include also the tail of the collector current

2.1 Electrical characteristics (curves)

Figure 2. Output characteristics

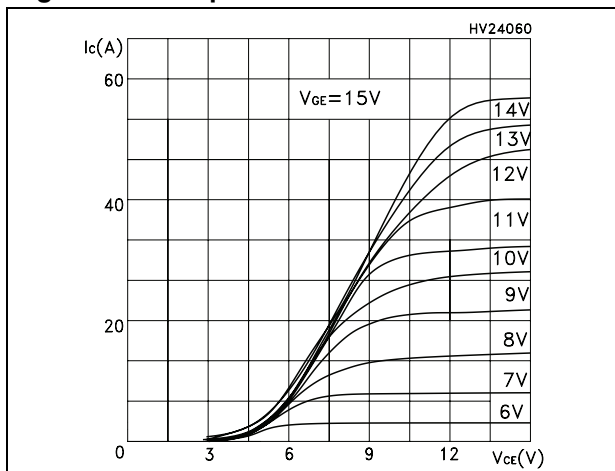

Figure 3. Transfer characteristics

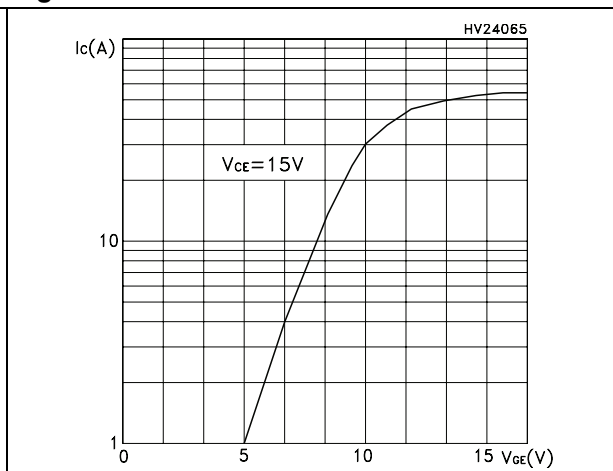

Figure 4. Transconductance

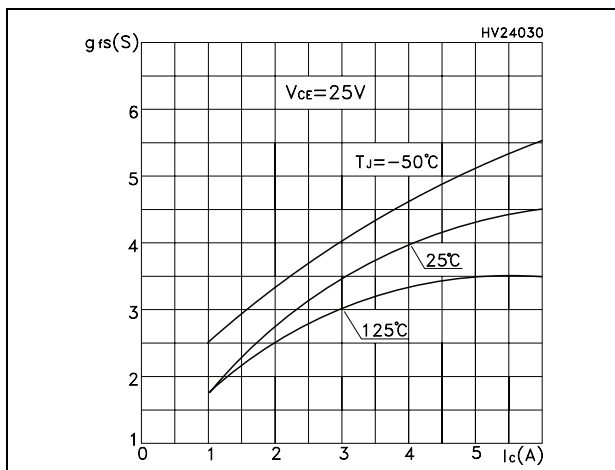

Figure 5. Collector-emitter on voltage vs. temperature

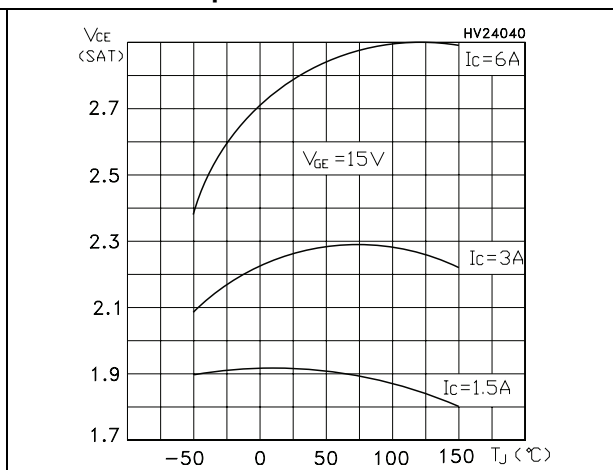

Figure 6. Collector-emitter on voltage vs. collector current

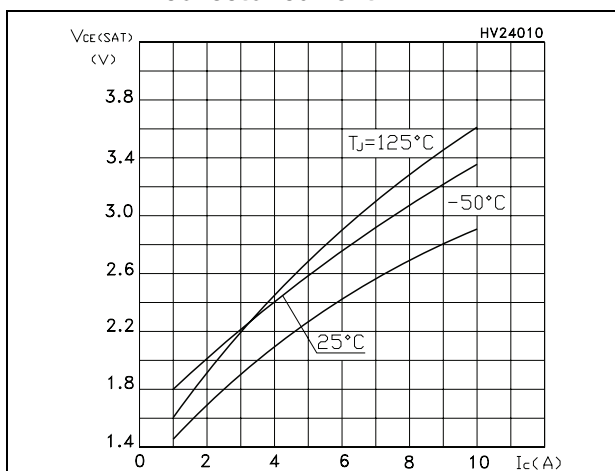

Figure 7. Normalized gate threshold voltage vs. temperature

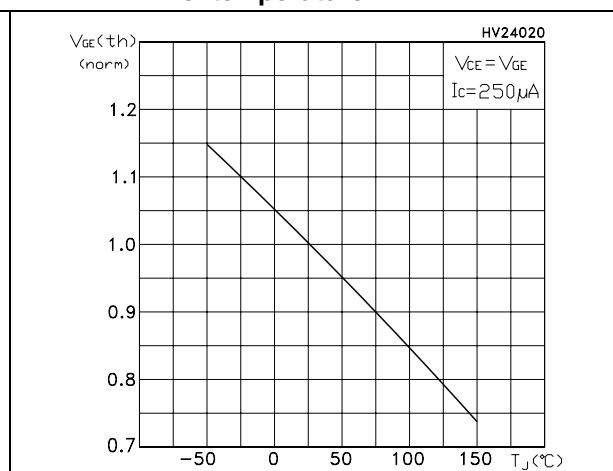

Figure 8. Normalized breakdown voltage vs. temperature

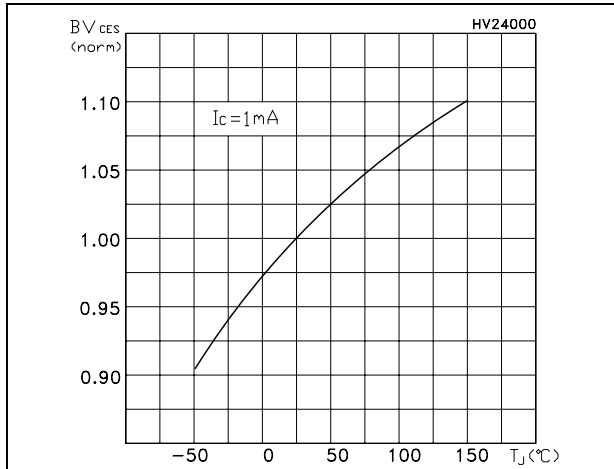

Figure 9. Gate charge vs. gate-source voltage

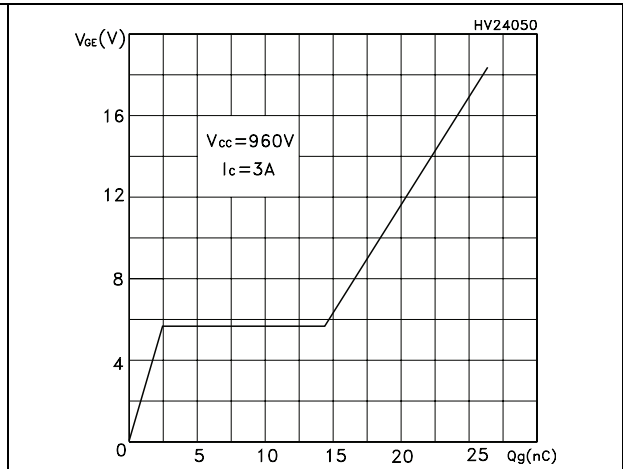

Figure 10. Capacitance variations

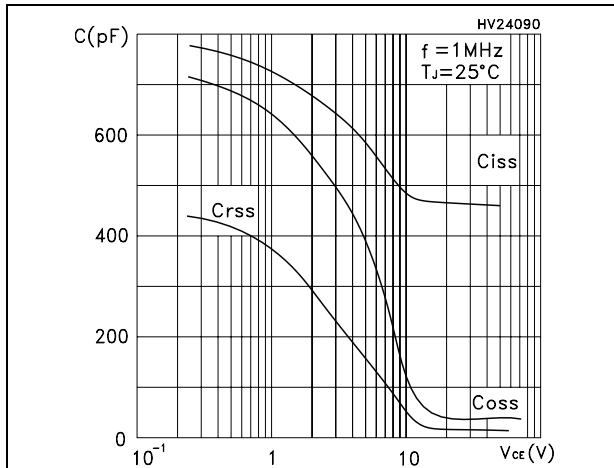

Figure 11. Switching losses vs. temperature

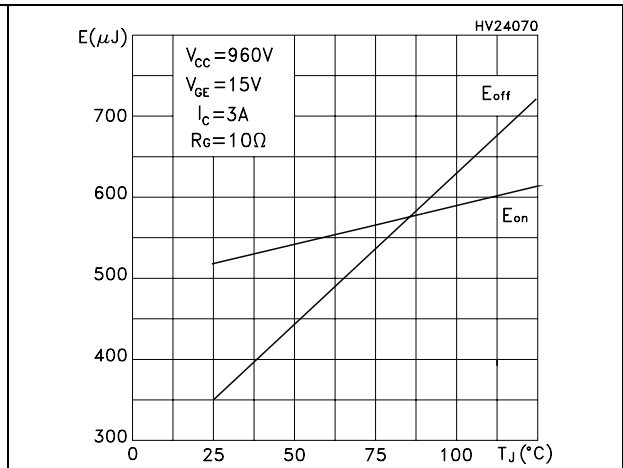

Figure 12. Switching losses vs. gate resistance

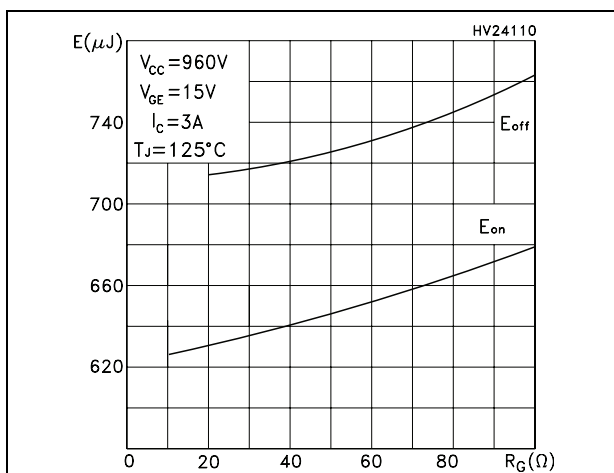

Figure 13. Switching losses vs. collector current

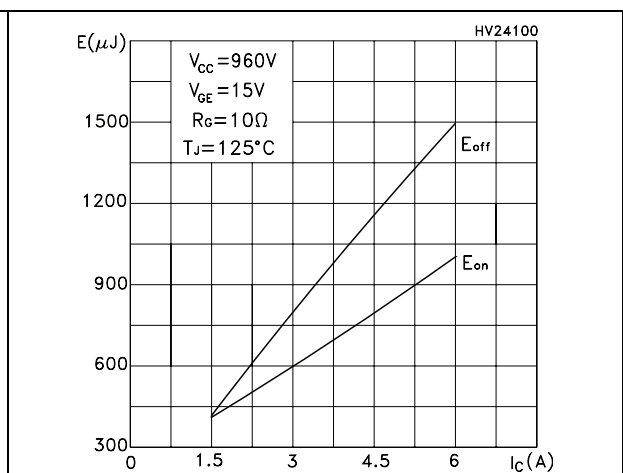

Figure 14. Power losses @ $I_C = 3\text{ A}$

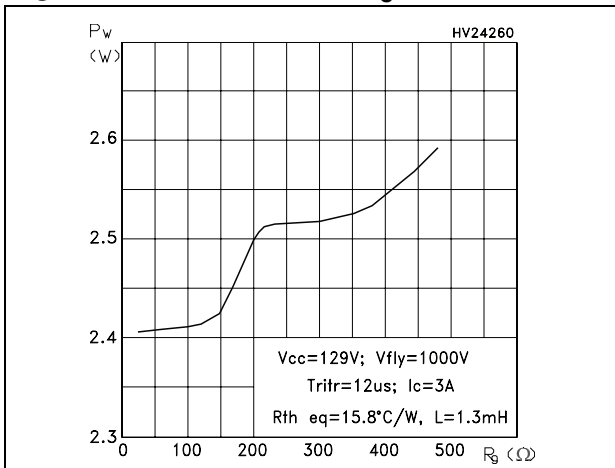

Figure 15. Power losses @ $I_C = 2\text{ A}$

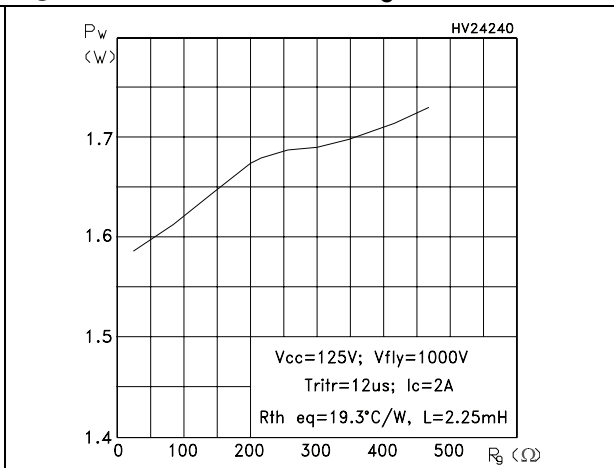

Figure 16. Turn-off SOA

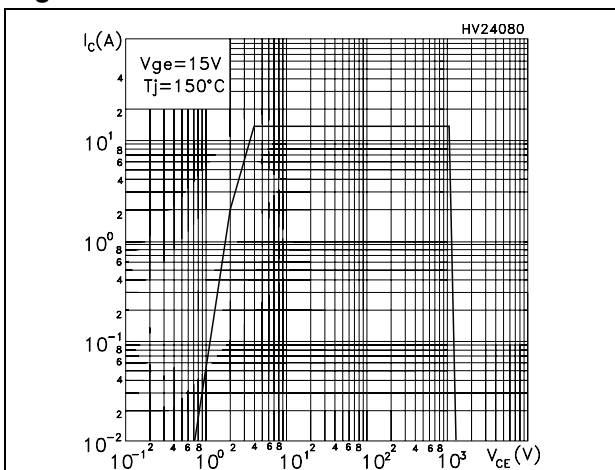
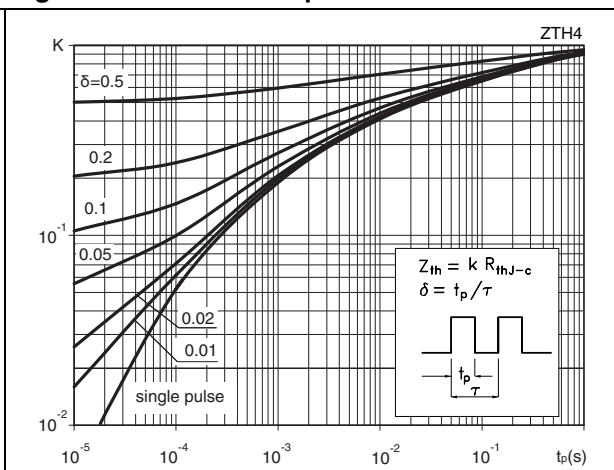

Figure 17. Thermal impedance



3 Test circuit

Figure 18. Test circuit for inductive load switching

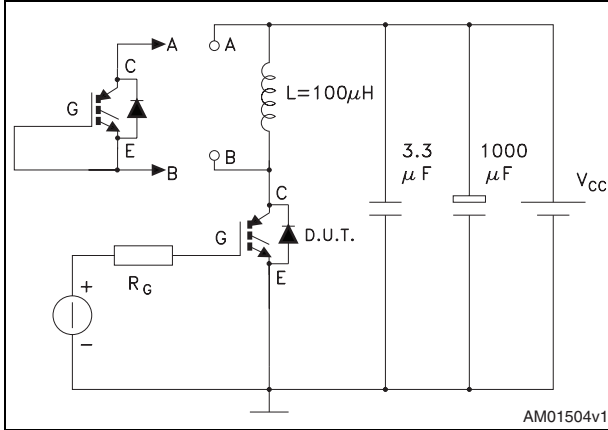

Figure 19. Gate charge test circuit

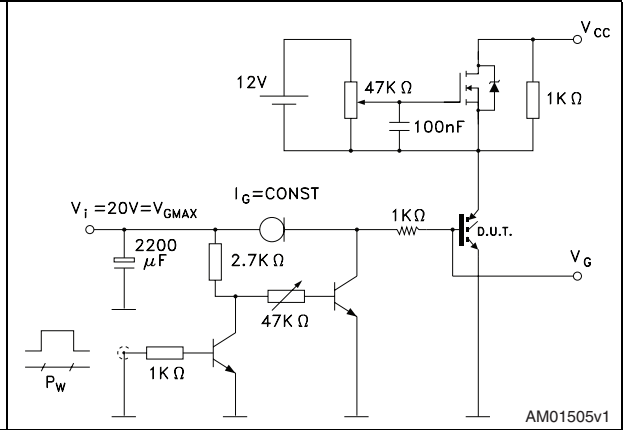
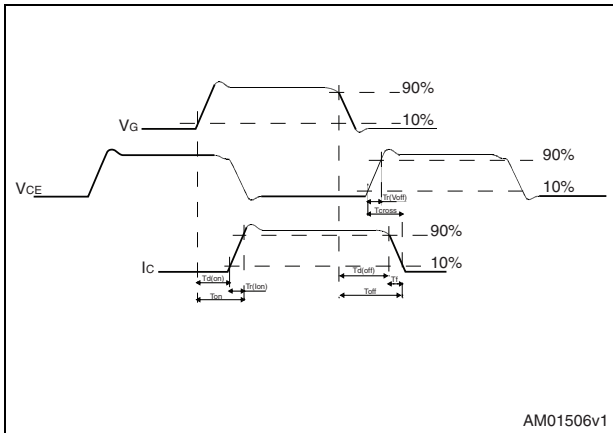

Figure 20. Switching waveform



4 Package mechanical data

In order to meet environmental requirements, ST offers these devices in different grades of ECOPACK[®] packages, depending on their level of environmental compliance. ECOPACK[®] specifications, grade definitions and product status are available at: www.st.com. ECOPACK[®] is an ST trademark.

Table 8. IPAK (TO-251) mechanical data

DIM.	mm.		
	min.	typ	max.
A	2.20		2.40
A1	0.90		1.10
b	0.64		0.90
b2			0.95
b4	5.20		5.40
B5		0.3	
c	0.45		0.60
c2	0.48		0.60
D	6.00		6.20
E	6.40		6.60
e		2.28	
e1	4.40		4.60
H		16.10	
L	9.00		9.40
L1	0.80		1.20
L2		0.80	1.00
V1		10 °	

Figure 21. IPAK (TO-251) drawing

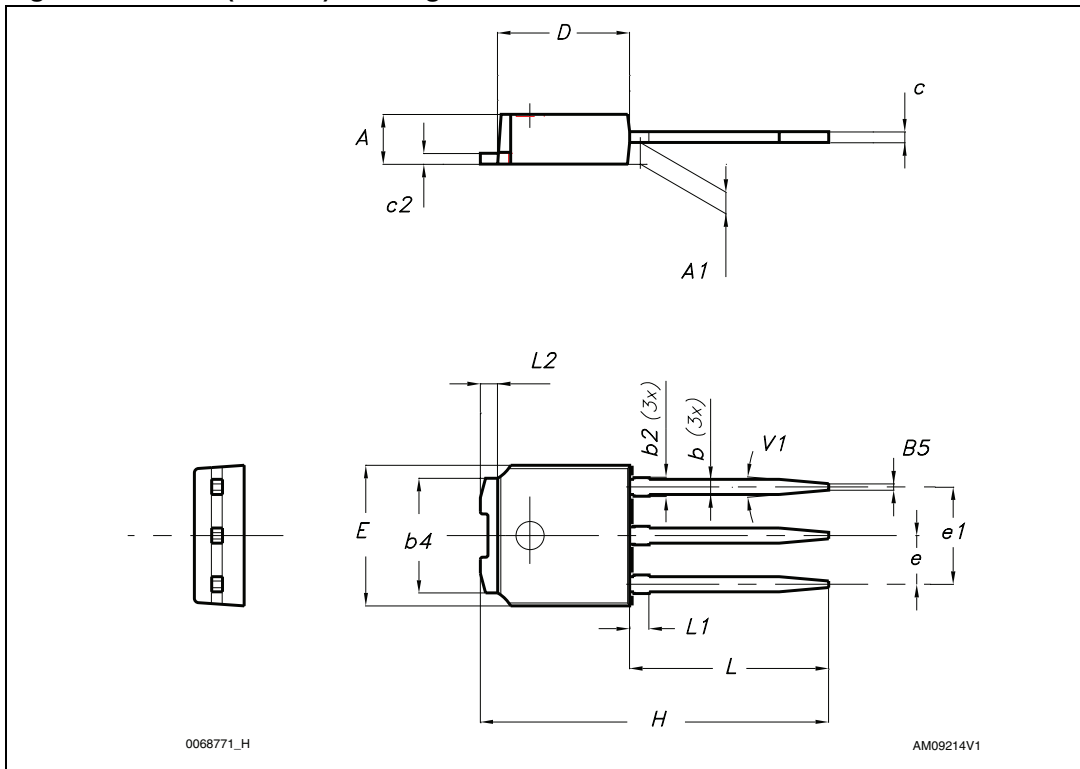

5 Revision history

Table 9. Document revision history

Date	Revision	Changes
27-Jun-2012	1	First release.

Please Read Carefully:

Information in this document is provided solely in connection with ST products. STMicroelectronics NV and its subsidiaries ("ST") reserve the right to make changes, corrections, modifications or improvements, to this document, and the products and services described herein at any time, without notice.

All ST products are sold pursuant to ST's terms and conditions of sale.

Purchasers are solely responsible for the choice, selection and use of the ST products and services described herein, and ST assumes no liability whatsoever relating to the choice, selection or use of the ST products and services described herein.

No license, express or implied, by estoppel or otherwise, to any intellectual property rights is granted under this document. If any part of this document refers to any third party products or services it shall not be deemed a license grant by ST for the use of such third party products or services, or any intellectual property contained therein or considered as a warranty covering the use in any manner whatsoever of such third party products or services or any intellectual property contained therein.

UNLESS OTHERWISE SET FORTH IN ST'S TERMS AND CONDITIONS OF SALE ST DISCLAIMS ANY EXPRESS OR IMPLIED WARRANTY WITH RESPECT TO THE USE AND/OR SALE OF ST PRODUCTS INCLUDING WITHOUT LIMITATION IMPLIED WARRANTIES OF MERCHANTABILITY, FITNESS FOR A PARTICULAR PURPOSE (AND THEIR EQUIVALENTS UNDER THE LAWS OF ANY JURISDICTION), OR INFRINGEMENT OF ANY PATENT, COPYRIGHT OR OTHER INTELLECTUAL PROPERTY RIGHT.

UNLESS EXPRESSLY APPROVED IN WRITING BY TWO AUTHORIZED ST REPRESENTATIVES, ST PRODUCTS ARE NOT RECOMMENDED, AUTHORIZED OR WARRANTED FOR USE IN MILITARY, AIR CRAFT, SPACE, LIFE SAVING, OR LIFE SUSTAINING APPLICATIONS, NOR IN PRODUCTS OR SYSTEMS WHERE FAILURE OR MALFUNCTION MAY RESULT IN PERSONAL INJURY, DEATH, OR SEVERE PROPERTY OR ENVIRONMENTAL DAMAGE. ST PRODUCTS WHICH ARE NOT SPECIFIED AS "AUTOMOTIVE GRADE" MAY ONLY BE USED IN AUTOMOTIVE APPLICATIONS AT USER'S OWN RISK.

Resale of ST products with provisions different from the statements and/or technical features set forth in this document shall immediately void any warranty granted by ST for the ST product or service described herein and shall not create or extend in any manner whatsoever, any liability of ST.

ST and the ST logo are trademarks or registered trademarks of ST in various countries.

Information in this document supersedes and replaces all information previously supplied.

The ST logo is a registered trademark of STMicroelectronics. All other names are the property of their respective owners.

© 2012 STMicroelectronics - All rights reserved

STMicroelectronics group of companies

Australia - Belgium - Brazil - Canada - China - Czech Republic - Finland - France - Germany - Hong Kong - India - Israel - Italy - Japan - Malaysia - Malta - Morocco - Philippines - Singapore - Spain - Sweden - Switzerland - United Kingdom - United States of America

www.st.com

