

IEC Appliance Inlet C14 with Filter, Line Switch 1- or 2-pole, PCB Mounting

Standard- or Medical-Filter



V-Lock



**Description**

- Panel Mount :  
Screw-on mounting on PCB from rear-side
- 3 Functions :  
Appliance Inlet Protection class I , Line Switch 1- or 2-pole , Line filter in standard and medical version
- For PCB mounting

**Approvals**

- VDE Certificate Number: 40001522
- UL File Number: E72928

**Characteristics**

- Ultra-compact design
- All single elements are already wired
- Line switch non-illuminated or illuminated
- With EMC-shield
- Especially suitable for use in switching power supplies  
Ideal for application with high transient loads
- Suitable for use in equipment according to IEC/UL 60950  
Suitable for use in medical equipment according to IEC/UL 60601-1

**Other versions on request**

- Fixing on PCB with self-tapping screws 3 mm or pre-inserted nuts M3
- Other rocker marking
- Illuminated green
- Medical version M80
- Capacitance CX1

**References**

- Alternative: version without line filter [DC21](#)
- Alternative: Standard version [DC21](#)

**Weblinks**

[pdf datasheet](#), [html-datasheet](#), [General Product Information](#), [RoHS](#), [CHINA-RoHS](#), [REACH](#), [Distributor-Stock-Check](#), [Accessories](#), [Detailed request for product](#)

Newly available variants corresponding to V-Lock mating cordset. The connector is equipped with a notch intended for use with the latching cordset. The cord latching system prevents against accidental removal of the cordset.

**Technical Data**

Ratings IEC	1 - 10A @ Ta 40 °C / 250VAC; 50Hz	appliance inlet/-outlet	C14 acc. to IEC 60320-1, UL 498 CSA C22.2 no. 42 (for cold conditions) pin-temperature 70 °C, 10A, Protection Class I
Ratings UL/CSA	1 - 10A @ Ta 40 °C / 125VAC; 60Hz	Line Switch	Rocker switch 1 or 2 pole, non-illuminated or illuminated red, acc. to IEC 61058-1 <a href="#">Technical Details</a>
Leakage Current	standard < 0.5 mA (250V / 60Hz) medical < 5 µA (250 V / 60 Hz)	Line Filter	Standard and Medical Version, IEC 60939, UL 1283, CSA C22.2 no. 8 <a href="#">Technical Details</a>
Dielectric Strength	> 1.7 kVDC between L-N > 2.7 kVDC between L/N-PE Test voltage (2 sec)	MTBF	> 2'100'000h acc. to MIL-HB-217 F
Allowable Operation Temperature	-25 °C to 85 °C		
Climatic Category	25/085/21 acc. to IEC 60068-1		
IP-Protection	from front side IP 40 acc. to IEC 60529		
Protection Class	Suitable for appliances with protection class I acc. to IEC 61140		
Terminal	For PCB mounting ; Ground terminal: Quick connect terminals 6.3 x 0.8 mm angled to pin axis		
Panel Thickness s	Screw: max 4 mm Mounting screw torque max 0.5Nm		
Material: Housing	Thermoplastic, black, UL 94V-0		

Detailed information on product approvals, code requirements, usage instructions and detailed test conditions can be looked up in [General Product Information](#)

**Dimension**

Screw-on mounting

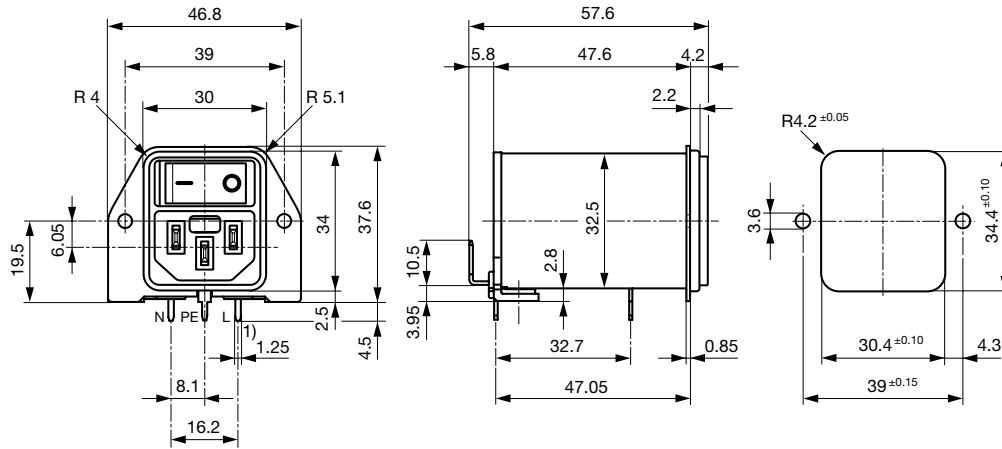

1) all pins

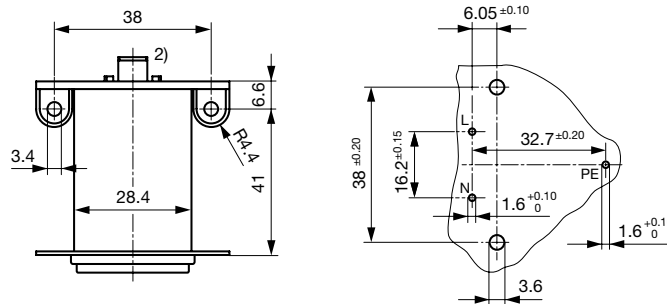

2) PE additionally as quick-connect terminal 6.3 x 0.8

**Technical Data of Filter-Components**

Rated Current [A]	Filter-Type	Inductances L [mH]	Capacitance CX [nF]	Capacitance CY [nF]	R [MΩ]
1	Standard Version	2 x 10	100	2.2	1
2	Standard Version	2 x 4	100	2.2	1
4	Standard Version	2 x 1.5	100	2.2	1
6	Standard Version	2 x 0.8	100	2.2	1
10	Standard Version	2 x 0.3	100	2.2	1
1	Medical Version (M5)	2 x 10	100	-	1
2	Medical Version (M5)	2 x 4	100	-	1
4	Medical Version (M5)	2 x 1.5	100	-	1
6	Medical Version (M5)	2 x 0.8	100	-	1
10	Medical Version (M5)	2 x 0.3	100	-	1

Diagrams

Standard filter 1-pole

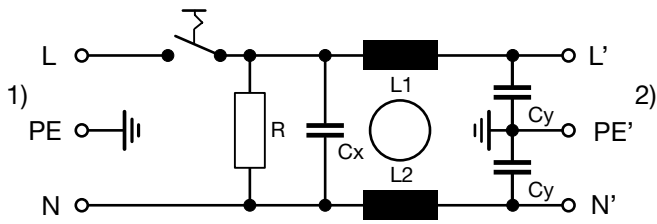

1) Line  
2) Load

Standard filter 2-pole

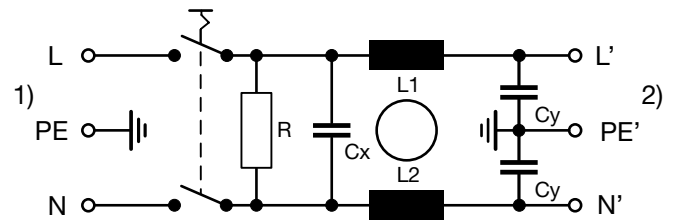

1) Line  
2) Load

Medical filter 1-pole (M5)

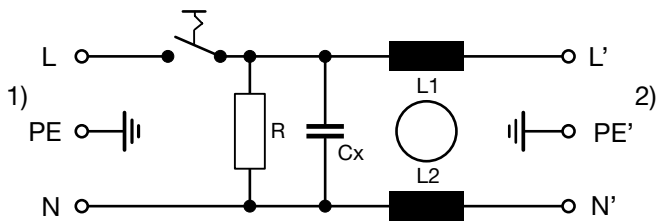

1) Line  
2) Load

Medical filter 2-pole (M5)

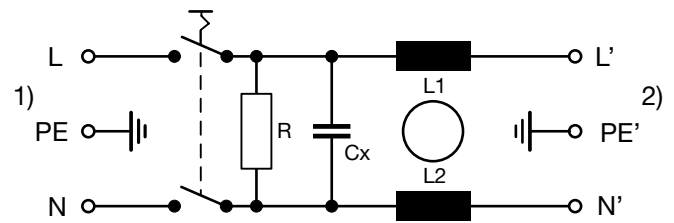

1) Line  
2) Load

Standard filter 2-pole illuminated

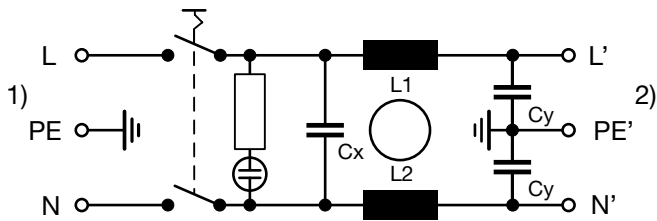

1) Line  
2) Load

Medical Filter 2-pole (M5) illuminated

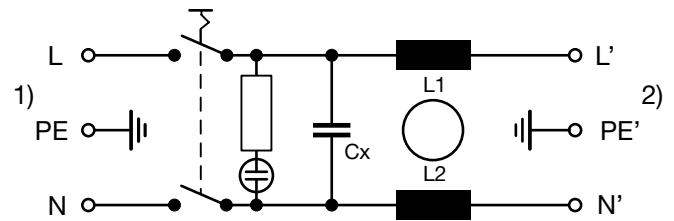

1) Line  
2) Load

**Attenuation Loss**

--- 50Ω differential mode    \_\_\_\_ 50Ω common mode

Standard version

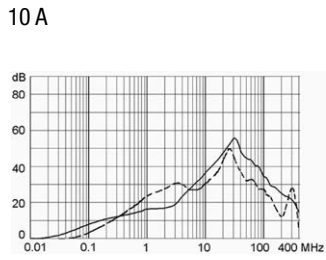
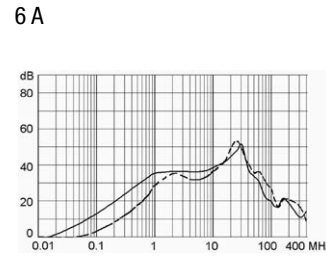
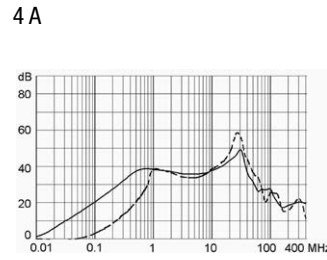
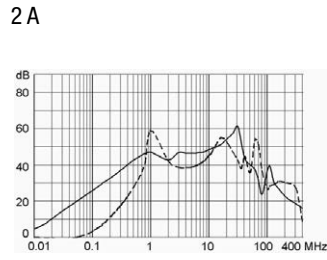
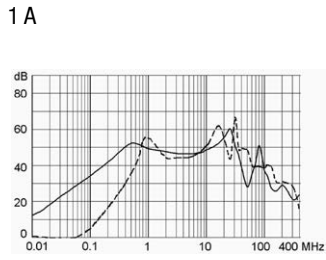

Medical version (M5)

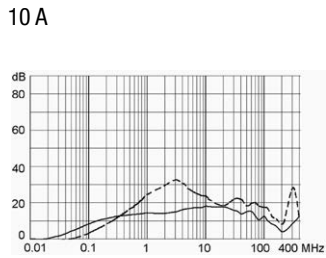
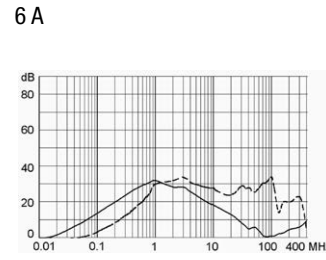
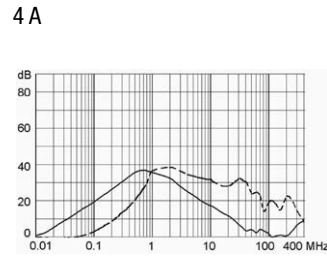
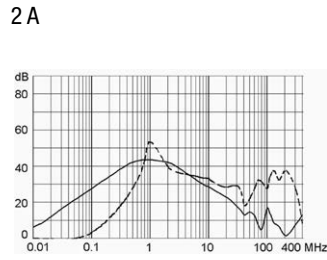
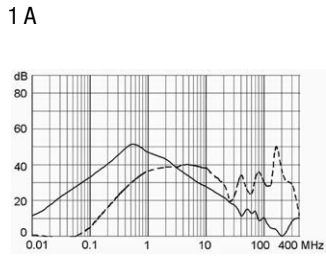

**All Variants**

Rated current	Filter-Type	Line Switch	Illumination	Color	V-Lock
1	Standard Version	1-pole		-	1
2	Standard Version	1-pole		-	1
4	Standard Version	1-pole		-	1
6	Standard Version	1-pole		-	1
10	Standard Version	1-pole		-	1
1	Standard Version	2-pole		-	1
2	Standard Version	2-pole		-	1
4	Standard Version	2-pole		-	1
6	Standard Version	2-pole		-	1
10	Standard Version	2-pole		-	1
1	Standard Version	2-pole	●	red	1
2	Standard Version	2-pole	●	red	1
4	Standard Version	2-pole	●	red	1
6	Standard Version	2-pole	●	red	1
10	Standard Version	2-pole	●	red	1

Rated current	Filter-Type	Line Switch	Illumination	Color	V-Lock
1	Medical Version (M5)	2-pole		-	1
2	Medical Version (M5)	2-pole		-	1
4	Medical Version (M5)	2-pole		-	1
6	Medical Version (M5)	2-pole		-	1
10	Medical Version (M5)	2-pole		-	1
1	Medical Version (M5)	2-pole	●	red	1
2	Medical Version (M5)	2-pole	●	red	1
4	Medical Version (M5)	2-pole	●	red	1
6	Medical Version (M5)	2-pole	●	red	1
10	Medical Version (M5)	2-pole	●	red	1

Availability for all products can be searched real-time: <http://www.schurter.com/en/Stock-Check/Stock-Check-SCHURTER>

**Packaging unit** 10 Pcs

### Accessories

#### Description



[Cord retaining kits](#)  
Cord retaining strain relief

Flat head, H

4700.0008

### Mating Outlets/Connectors

#### Category / Description

#### [Appliance Outlet Overview complete](#)



IEC Appliance Outlet F, Screw-on Mounting, Front Side, Solder Terminal

4787

IEC Appliance Outlet F, Snap-in Mounting, Front Side, Solder or Quick-connect Terminal

4788

IEC Appliance Outlet F or H, Screw-on Mounting, Front Side, Solder, PCB or Quick-connect Terminal

5091

[Appliance Outlet further types to DC22](#)

#### [Connector Overview complete](#)



4782 Mounting: Power Cord, 3 x 1 mm<sup>2</sup> / 3 x 18 AWG, Cable, Connector: IEC C13

4782

4022 Mounting: Power Supply Cord, 3 x 1.5 mm<sup>2</sup>, Screw clamps, Connector: IEC C13

4022

4785 Mounting: Power Cord, 3 x 1 mm<sup>2</sup> / 3 x 18 AWG, Cable, Connector: IEC C13

4785

4300-06 Mounting: Power Cord, 3 x 1 mm<sup>2</sup> / 3 x 18 AWG, Cable, Connector: IEC C13

4300-06

4012 Mounting: Power Supply Cord, 3 x 1.5 mm<sup>2</sup>, Screw clamps, Connector: IEC C13

4012

[Connector further types to DC22](#)

...

Mating Outlets/Connectors shuttered



[Power Cord Overview complete](#)

[VAC13KS, Overview, diverse Connector IEC C13, cord end:](#)

[VAC13KS](#)

[Power Cord further types to DC22](#)