

Monolithic Dual Tracking 3A Step-Down Switching Regulator

DESCRIPTION

The demo circuit 1537A is a dual current mode PWM step-down DC/DC converter featuring LT[®]3992. The demo circuit is designed for 5V and 3.3V outputs from a 7V to 60V input. The current capability of each channel is up to 3A when running individually and 2A when both are sourcing the same current without special heat sinking. Individual soft-start, current limit, comparator, input voltage for each output as well as frequency division and synchronous and clock output functions simplify the complex design of dual-output power converters.

Both converters are synchronized to either a common external clock input or a resistor programmable 250kHz to 2MHz internal oscillator. At all frequencies, a 180° phase shift between channels is maintained, reducing voltage ripple. Programmable frequency allows optimization between efficiency and external component size. Each output can be independently disabled using its own SHDN pin and be placed in a low quiescent current shutdown mode.

The LT3992 data sheet gives complete description of the device, operation and application information. The data

sheet must be read in conjunction with this quick start guide for demo circuit 1537A.

Design files for this circuit board are available at <http://www.linear.com/demo>

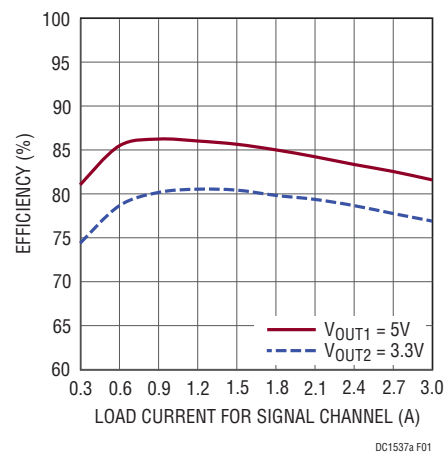

Figure 1. Single Channel Efficiency at $V_{IN} = 24V$, $f = 300kHz$

LT, LT, LTC, LTM, Linear Technology and the Linear logo are registered trademarks of Linear Technology Corporation. All other trademarks are the property of their respective owners.

PERFORMANCE SUMMARY Specifications are at $T_A = 25^\circ C$.

PARAMETER	CONDITIONS	VALUE
Minimum Input Voltage		7V
Maximum Input Voltage		60V (For Transient. Continuous Operation if D3 and D4 Are Replaced with Higher Voltage Rated Schottky Diodes)
Output Voltage V_{OUT1}	$V_{IN} = 7 \sim 60V$	5.0V $\pm 3\%$
Output Voltage V_{OUT2}	$V_{IN} = 7 \sim 60V$	3.3V $\pm 3\%$
Switching Frequency		300kHz $\pm 10\%$
Maximum Output Current I_{OUT1}	$V_{IN} = 7 \sim 60V$	3A Individually, 2A Both Running
Maximum Output Current I_{OUT2}	$V_{IN} = 7 \sim 60V$	3A Individually, 2A Both Running
Voltage Ripple V_{OUT1}	$V_{IN} = 12V, I_{OUT1} = 3A$	<20mV
Voltage Ripple V_{OUT2}	$V_{IN} = 12V, I_{OUT2} = 3A$	<20mV

DESCRIPTION

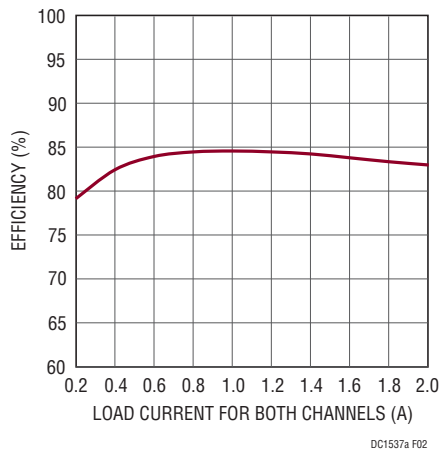

Figure 2. Dual Channel Efficiency at $V_{IN} = 24V$, $f = 300kHz$

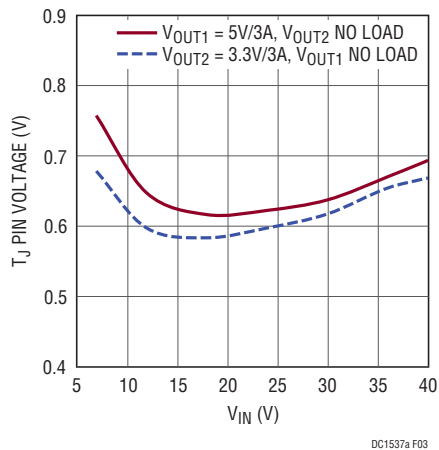

Figure 3. DC1537A T_J Pin Voltage When Channels Running Individually at 3A Load ($T_A = 25^\circ C$)

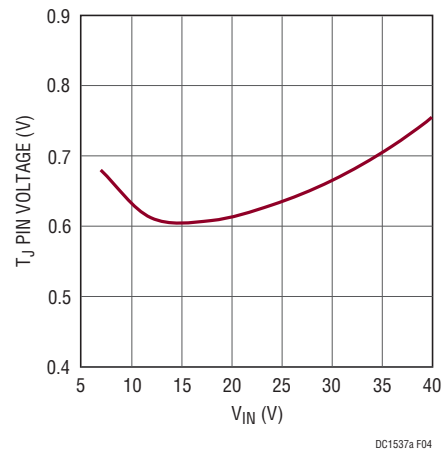

Figure 4. DC1537A T_J Pin Voltage When Both Channels Sourcing 2A Current at Meantime ($T_A = 25^\circ C$)

QUICK START PROCEDURE

Demo circuit 1537A is easy to set up to evaluate the performance of the LT3992. Refer to Figure 5 for proper measurement equipment setup and follow the procedure below:

NOTE. When measuring the input or output voltage ripple, care must be taken to avoid a long ground lead on the oscilloscope probe. Measure the input or output voltage ripple by touching the probe tip directly across the VIN or VOUT and GND terminals. See Figure 6 for proper scope probe technique.

1. Place JP1 on the SINGLE position.
2. With power off, connect the input power supply to VIN1 and GND. (Connect another input power supply to VIN2 and GND if DUAL is selected.)
3. Turn on the power at the input.

NOTE. Make sure that the input voltage does not exceed 60V (Due to part selection on D3 and D4, 60V is for transient purpose. Continuous operation can be available after D3 and D4 are replaced with higher voltage rated schottky diodes).

4. Check for the proper output voltages.

NOTE. If there is no output, temporarily disconnect the load to make sure that the load is not set too high.

5. Once the proper output voltages are established, adjust the load within the operating range and observe the output voltage regulation, ripple voltage, efficiency and other parameters.

ADDITIONAL NOTES

If an EMI filter is desirable on VIN1, it can be feasibly installed on the back of the board in the optional circuit area. However, a trace cut is required for the insertion of the optional circuit. See Figure 7 for the cut line.

QUICK START PROCEDURE

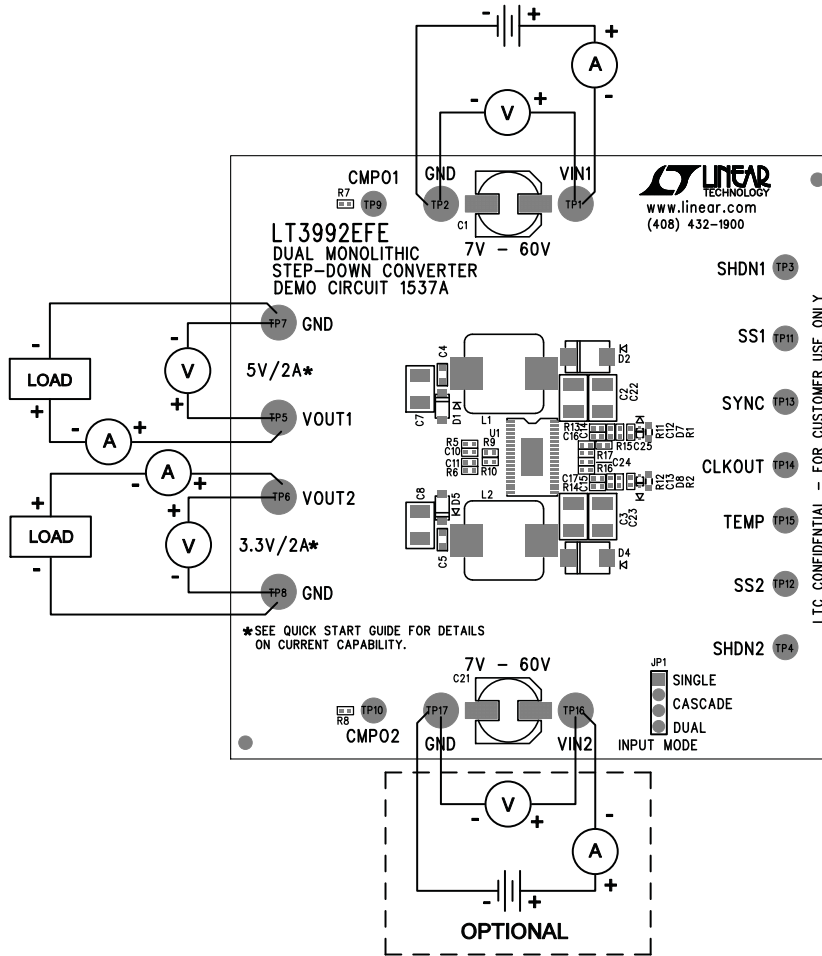

Figure 5. DC1537A Proper Equipment Setup

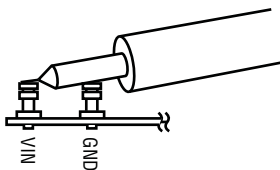

Figure 6. Measuring Input or Output Ripple

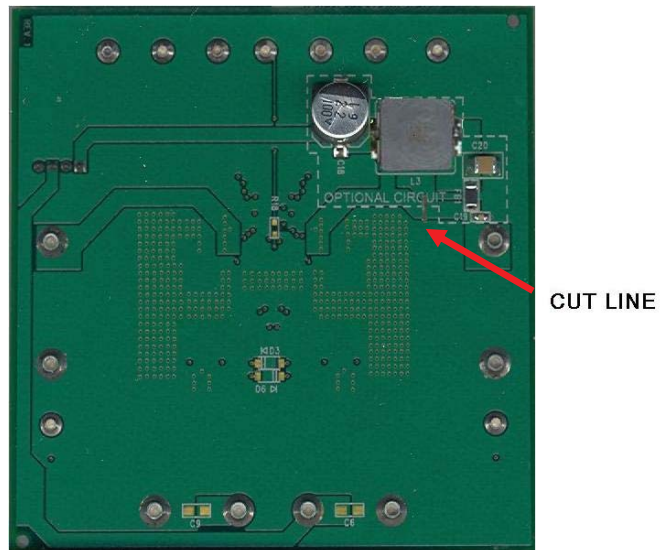

Figure 7. Cut Line for the EMI Filter Installation

DEMO MANUAL DC1537A

PARTS LIST

ITEM	QTY	REFERENCE	PART DESCRIPTION	MANUFACTURER/PART NUMBER
Required Circuit Components				
1	4	C2, C3, C22, C23	CAP, 1210 2.2 μ F 10% 100V X7R	AVX 12101C225KAT2A
2	2	C4, C5	CAP, 0603 0.47 μ F 10% 25V X7R	MURATA GRM188R71E474KA12D
3	2	C7, C8	CAP, 1210 100 μ F 20% 10V X5R	TAIYO YUDEN LMK325ABJ107MM-T
4	2	C10, C11	CAP, 0402 22pF 10% 25V NPO	AVX 04023A220KAT2A
5	2	C12, C13	CAP, 0402 0.1 μ F 10% 16V X7R	TDK C1005X7R1C104K
6	2	C14, C15	CAP, 0402 680pF 10% 25V X7R	AVX 04023C681KAT2A
7	2	C16, C17	CAP, 0402 33pF 10% 25V NPO	AVX 04023A330KAT
8	1	C24	CAP, 0402 10nF 10% 16V X7R	MURATA GRM155R71C103KA01D
9	2	D1, D5	DIODE, SCHOTTKY BARRIER SOD123	ON SEMICONDUCTOR MMSD701T1G
10	2	D2, D4	DIODE, SCHOTTKY RECTIFIER SMB	DIODES INC. B360B
11	1	L1	IND, 22 μ H	NIC NPIM104B220MTRF
12	1	L2	IND, 10 μ H	NIC NPIM104B100MTRF
13	2	R1, R2	RES, 0603 1k Ω 1% 1/16W	NIC NRC06F1001TRF
14	1	R5	RES, 0402 42.2k Ω 1% 1/16W	VISHAY CRCW040242K2FKED
15	1	R6	RES, 0402 24.9k Ω 1% 1/16W	VISHAY CRCW040224K9FKED
16	2	R7, R8	RES, 0402 100k Ω 5% 1/16W	VISHAY CRCW0402100KJNED
17	2	R9, R10	RES, 0402 8.06k Ω 1% 1/16W	VISHAY CRCW04028K06FKED
18	2	R11, R12	RES, 0402 100k Ω 1% 1/16W	VISHAY CRCW0402100KFKED
19	2	R13, R14	RES, 0402 30k Ω 1% 1/16W	NIC NRC04F3002TRF
20	1	R15	RES, 0402 7.32k Ω 1% 1/16W	VISHAY CRCW04027K32FKED
21	1	R16	RES, 0402 20k Ω 1% 1/16W	VISHAY CRCW040220K0FKED
22	1	R17	RES, 0402 40.2k Ω 1% 1/16W	VISHAY CRCW040240K2FKED
23	1	U1	IC, STEP-DOWN REGULATOR	LINEAR TECHNOLOGY LT3992EFE
Additional Demo Board Circuit Components				
1	2	C1, C21	CAP, 22 μ F 20% 100V OSCON	SUNCON 100CE22BS
2	0	C6, C9	CAP, 0805 10 μ F 10% 16V X5R OPTION	MURATA GRM21BR61C106KE15L OPTION
3	0	C18	CAP, 22 μ F 20% 100V OSCON OPTION	SANYO 100CE22BS OPTION
4	0	C19	CAP, 0603 0.01 μ F 10% 100V X7R OPTION	AVX 06031C103KAT OPTION
5	0	C20	CAP, 1210 2.2 μ F 10% 100V X7R OPTION	AVX 12101C225KAT2A OPTION
6	0	C25	CAP, 0402 10nF 10% 16V X7R OPTION	MURATA GRM155R71C103KA01D OPTION
7	0	D3, D6	DIODE, SCHOTTKY BARRIER SOD123 OPTION	ON SEMICONDUCTOR MMSD701T1G OPTION
8	0	D7, D8	DIODE, OPT	OPTION
9	0	R18	RES, 0603 0 Ω JUMPER OPTION	VISHAY CRCW06030000Z0EA OPTION
10	0	FB1	FERRITE BEAD OPTION	TAIYO YUDEN FBMJ3216HS800 OPTION
11	0	L3	IND, 22 μ H OPTION	VISHAY IHLP4040DZ-01 OPTION
Hardware/Components (For Demo Board Only)				
1	1	JP1	HEADER, 4-PIN	SAMTEC TMM-104-02-L-S
2	8	TP1, TP2, TP5 TO TP8, TP16, TP17	TURRET	MILL-MAX 2501-2-00-80-00-00-07-0
3	9	TP3, TP4, TP9 TO TP15	TURRET	MILL-MAX 2308-2-00-80-00-00-07-0
4	1	JP1	SHUNT, 2mm	SAMTEC 2SN-BK-G

SCHEMATIC DIAGRAM

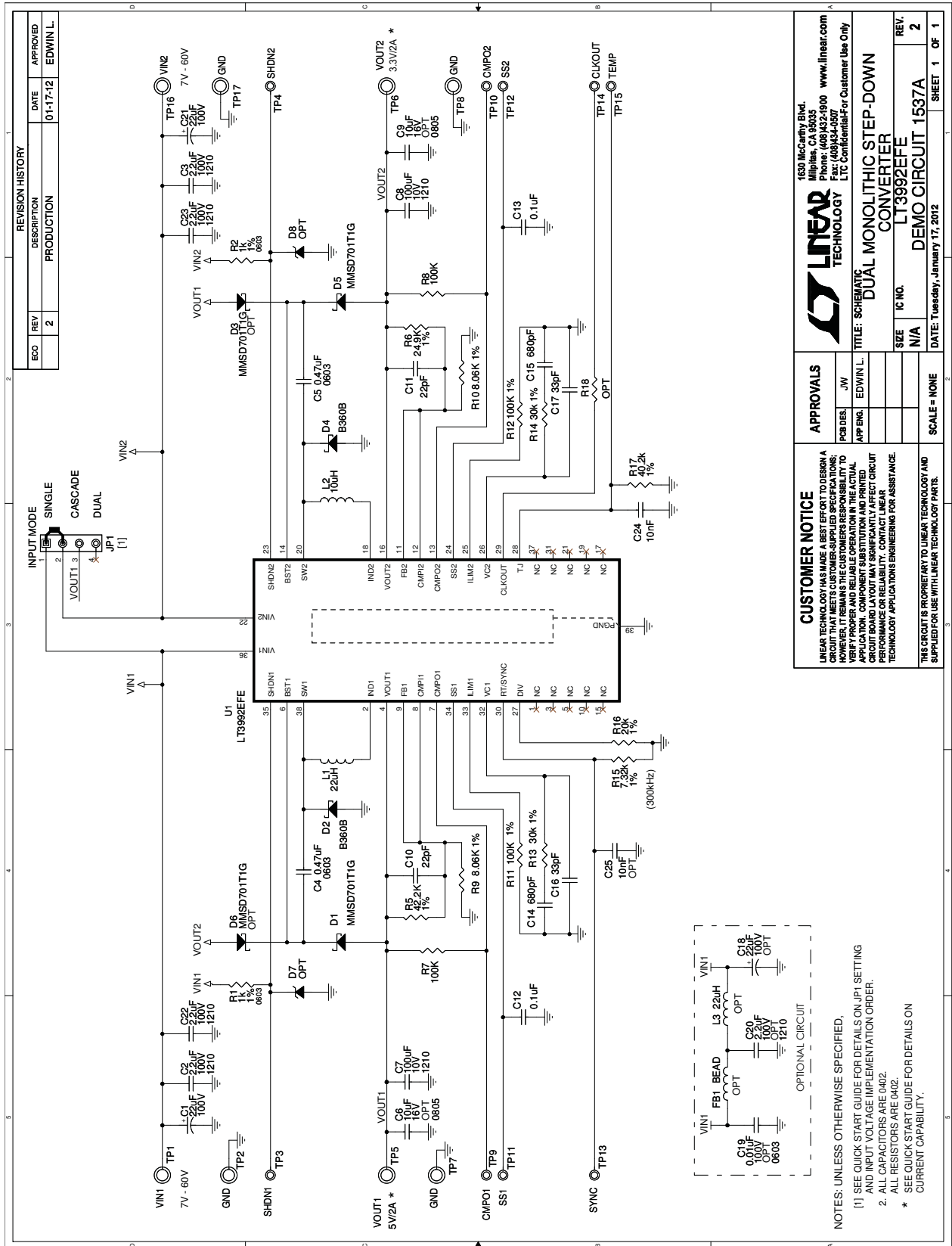

DEMO MANUAL DC1537A

DEMONSTRATION BOARD IMPORTANT NOTICE

Linear Technology Corporation (LTC) provides the enclosed product(s) under the following **AS IS** conditions:

This demonstration board (DEMO BOARD) kit being sold or provided by Linear Technology is intended for use for **ENGINEERING DEVELOPMENT OR EVALUATION PURPOSES ONLY** and is not provided by LTC for commercial use. As such, the DEMO BOARD herein may not be complete in terms of required design-, marketing-, and/or manufacturing-related protective considerations, including but not limited to product safety measures typically found in finished commercial goods. As a prototype, this product does not fall within the scope of the European Union directive on electromagnetic compatibility and therefore may or may not meet the technical requirements of the directive, or other regulations.

If this evaluation kit does not meet the specifications recited in the DEMO BOARD manual the kit may be returned within 30 days from the date of delivery for a full refund. **THE FOREGOING WARRANTY IS THE EXCLUSIVE WARRANTY MADE BY THE SELLER TO BUYER AND IS IN LIEU OF ALL OTHER WARRANTIES, EXPRESSED, IMPLIED, OR STATUTORY, INCLUDING ANY WARRANTY OF MERCHANTABILITY OR FITNESS FOR ANY PARTICULAR PURPOSE. EXCEPT TO THE EXTENT OF THIS INDEMNITY, NEITHER PARTY SHALL BE LIABLE TO THE OTHER FOR ANY INDIRECT, SPECIAL, INCIDENTAL, OR CONSEQUENTIAL DAMAGES.**

The user assumes all responsibility and liability for proper and safe handling of the goods. Further, the user releases LTC from all claims arising from the handling or use of the goods. Due to the open construction of the product, it is the user's responsibility to take any and all appropriate precautions with regard to electrostatic discharge. Also be aware that the products herein may not be regulatory compliant or agency certified (FCC, UL, CE, etc.).

No License is granted under any patent right or other intellectual property whatsoever. **LTC assumes no liability for applications assistance, customer product design, software performance, or infringement of patents or any other intellectual property rights of any kind.**

LTC currently services a variety of customers for products around the world, and therefore this transaction **is not exclusive**.

Please read the DEMO BOARD manual prior to handling the product. Persons handling this product must have electronics training and observe good laboratory practice standards. **Common sense is encouraged.**

This notice contains important safety information about temperatures and voltages. For further safety concerns, please contact a LTC application engineer.

Mailing Address:

Linear Technology
1630 McCarthy Blvd.
Milpitas, CA 95035

Copyright © 2004, Linear Technology Corporation