

THIS DOCUMENT IS THE PROPERTY OF KEYSTONE ELECTRONICS CORP. AND SHALL NOT BE REPRODUCED, DISTRIBUTED OR USED AS A BASIS FOR MANUFACTURE WITHOUT PRIOR WRITTEN PERMISSION FROM KEYSTONE ELECTRONICS CORP.

ACTUAL SIZE

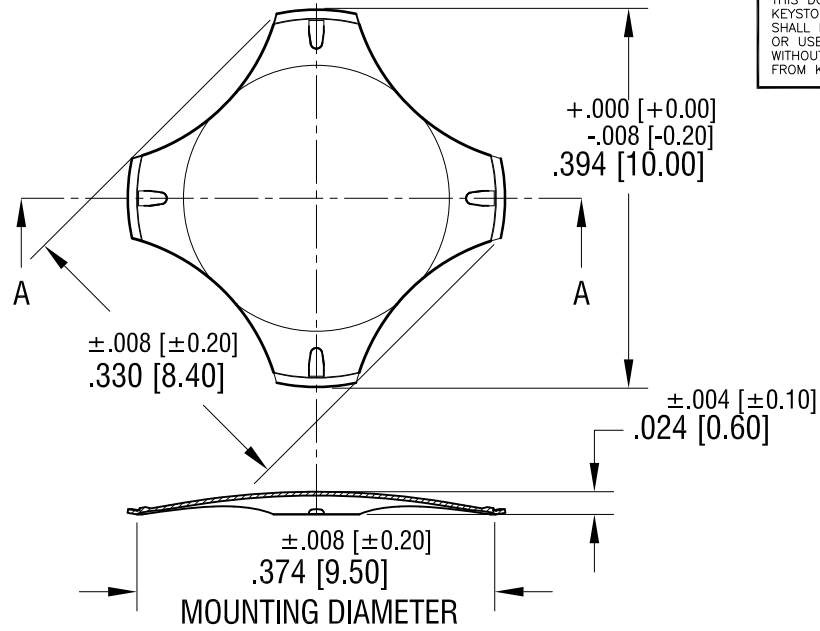

MTG DETAILS

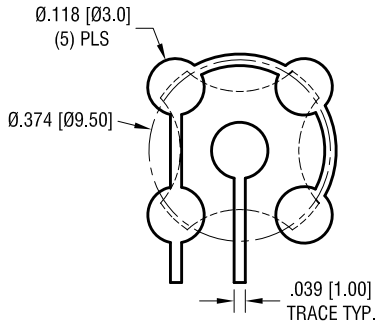

SECTION A-A

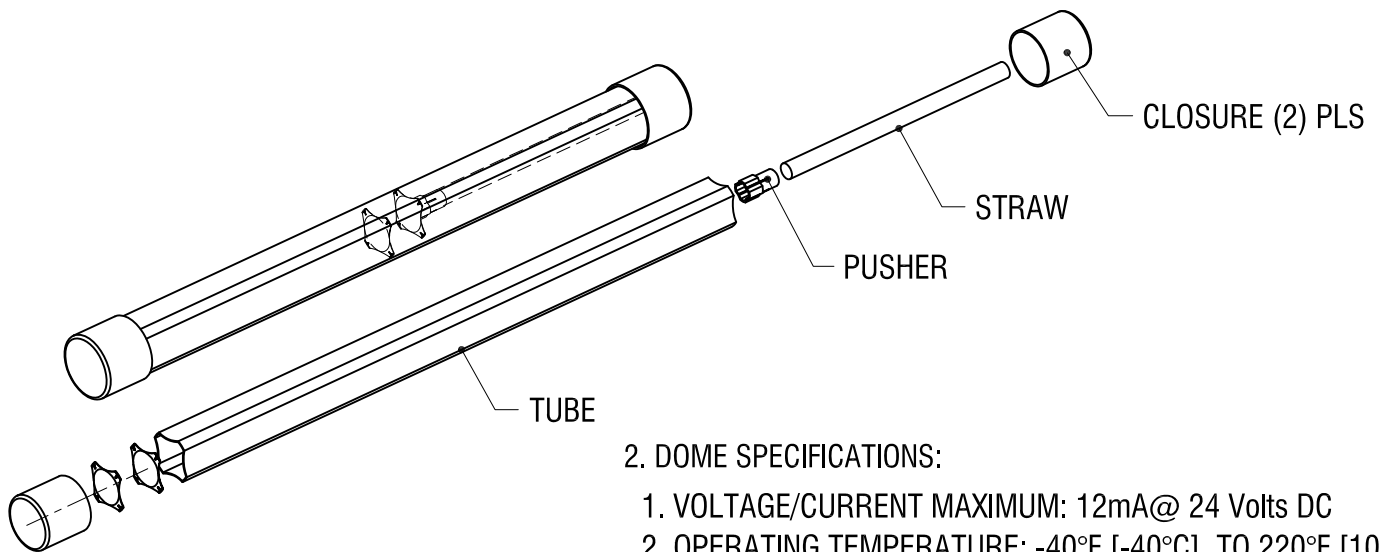

2. DOME SPECIFICATIONS:

1. VOLTAGE/CURRENT MAXIMUM: 12mA@ 24 Volts DC
2. OPERATING TEMPERATURE: -40°F [-40°C] TO 220°F [105°C]
3. STORAGE TEMPERATURE: -65°F [-55°C] TO 250°F [125°C]
4. MAT'L: .004 [0.10] STAINLESS STEEL
5. FINISH: NICKEL PLATE
6. TRIP FORCE: 400g

NOTES: SUPPLIED IN TUBES

1. TUBE SPECIFICATIONS: 7.50 [190.40] LONG
800 DOMES PER TUBE

KEYSTONE ELECTRONICS CORP.			
www.keyelco.com • ASTORIA, N.Y. 11105-2017 • Tel (718) 956-8900			
PART NAME		COMPACT 4 LEG DOME	
MATERIAL		AS NOTED	
FINISH	AS NOTED	DRN BY	NT
		DATE	3.30.17
		APP'D	LN
		SCALE	5X; N/A
TOLERANCES	INCH [MM]	CODE	DWG NO.
DECIMAL	± .005 [± 0.13]	C	5156
ANGULAR	± 1°		
UNLESS OTHERWISE SPECIFIED			

DATE	DESCRIPTION	REV.	
------	-------------	------	--