

300V HYPERFAST RECTIFIER

MAJOR PRODUCT CHARACTERISTICS

$I_{F(AV)}$	8 A
V_{RRM}	300 V
I_{RM} (typ.)	4A
T_j (max)	175 °C
V_F (max)	1.3 V
t_{rr} (max)	30 ns

FEATURES AND BENEFITS

- Designed for high frequency applications.
- Hyperfast recovery competes with GaAs devices.
- Allows size decrease of snubbers and heatsinks.

DESCRIPTION

The TURBOSWITCH "R" is an ultra high performance diode. This TURBOSWITCH family, which drastically cuts losses in associated MOSFET when run at high dI_F/dt , is suited for HF OFF-Line SMPS and DC/DC converters.

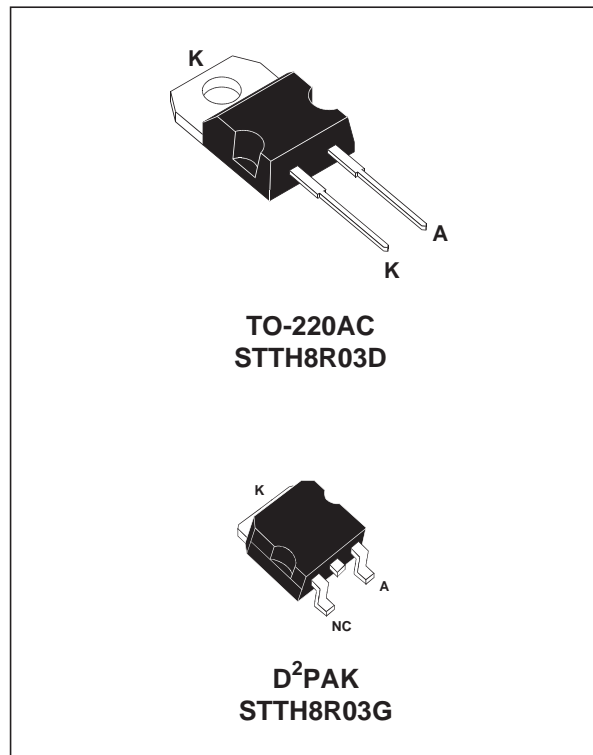

ABSOLUTE RATINGS (limiting values, per diode)

Symbol	Parameter		Value	Unit
V_{RRM}	Repetitive peak reverse voltage		300	V
$I_{F(RMS)}$	RMS forward current		20	A
$I_{F(AV)}$	Average forward current	$T_c = 140^\circ\text{C} \quad \delta = 0.5$	8	A
I_{FSM}	Surge non repetitive forward current	$t_p = 10 \text{ ms sinusoidal}$	80	A
T_{stg}	Storage temperature range		- 65 + 175	°C
T_j	Maximum operating junction temperature		+ 175	°C

STTH8R03G/D

THERMAL AND POWER DATA

Symbol	Parameter	Value	Unit
$R_{th(j-c)}$	Junction to case	2.5	°C/W

STATIC ELECTRICAL CHARACTERISTICS

Symbol	Parameter	Tests conditions	Min.	Typ.	Max.	Unit	
I_R^*	Reverse leakage current	$V_R = V_{RRM}$	$T_j = 25^\circ\text{C}$			10	μA
			$T_j = 125^\circ\text{C}$		15	100	
V_F^{**}	Forward voltage drop	$I_F = 8\text{ A}$	$T_j = 25^\circ\text{C}$			1.8	V
			$T_j = 125^\circ\text{C}$		1.05	1.3	

Pulse test : * $t_p = 5\text{ ms}$, $\delta < 2\%$

** $t_p = 380\ \mu\text{s}$, $\delta < 2\%$

To evaluate the maximum conduction losses use the following equation :

$$P = 0.9 \times I_{F(AV)} + 0.05 I_{F(RMS)}^2$$

RECOVERY CHARACTERISTICS

Symbol	Tests conditions	Min.	Typ.	Max.	Unit
t_{rr}	$I_F = 0.5\text{ A}$ $I_{rr} = 0.25\text{ A}$ $I_R = 1\text{ A}$		13	30	ns
	$I_F = 1\text{ A}$ $dI_F/dt = -50\text{ A}/\mu\text{s}$ $V_R = 30\text{ V}$				
I_{RM}	$V_R = 200\text{ V}$ $I_F = 8\text{ A}$ $dI_F/dt = -200\text{ A}/\mu\text{s}$		4	5.5	A
S factor			0.4		

TURN-ON SWITCHING CHARACTERISTICS

Symbol	Tests conditions	Min.	Typ.	Max.	Unit
t_{tr}	$T_j = 25^\circ\text{C}$ $I_F = 8\text{ A}$ $dI_F/dt = 100\text{ A}/\mu\text{s}$ measured at $1.1 \times V_{Fmax}$			200	ns
V_{FP}	$T_j = 25^\circ\text{C}$ $I_F = 8\text{ A}$ $dI_F/dt = 100\text{ A}/\mu\text{s}$			3.5	V

Fig. 1: Conduction losses versus average current

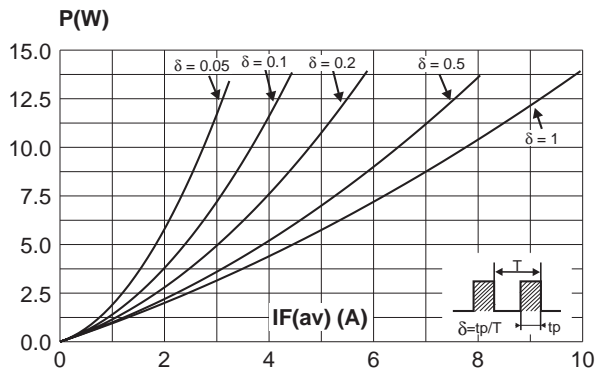

Fig. 2: Forward voltage drop versus forward current.

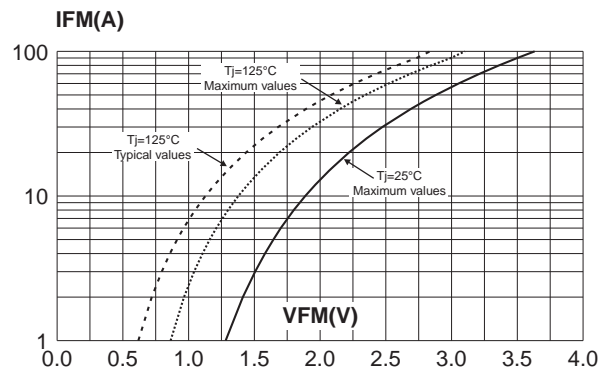

Fig. 3: Relative variation of thermal impedance junction to case versus pulse duration.

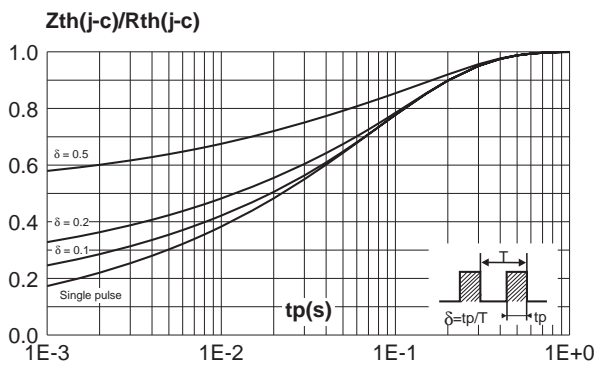

Fig. 4: Peak reverse recovery current versus dIF/dt (90% confidence).

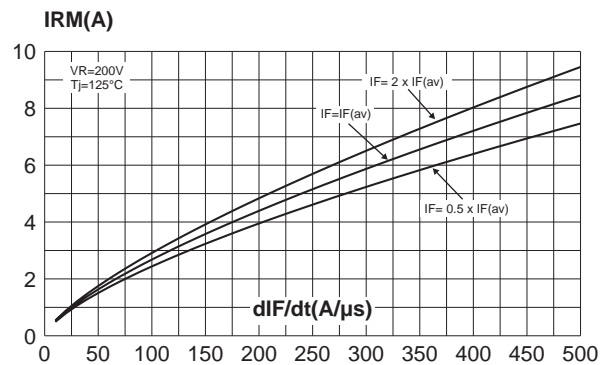

Fig. 5: Reverse recovery time versus dIF/dt (90% confidence).

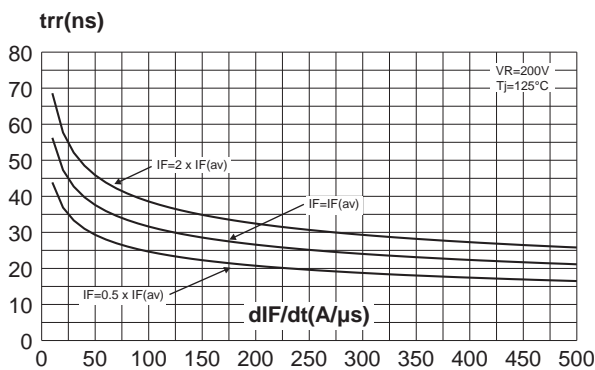
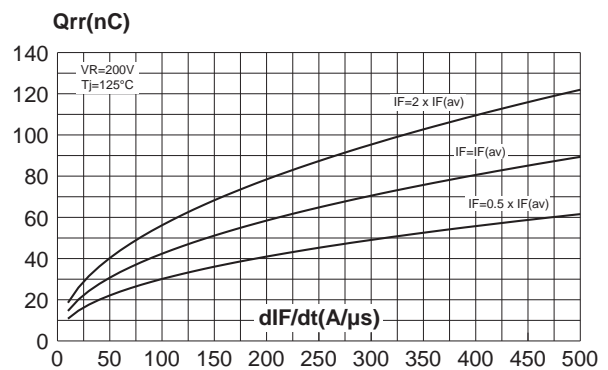

Fig. 6: Reverse recovery charges versus dIF/dt (90% confidence).



STTH8R03G/D

Fig. 7: Softness factor (tb/ta) versus dIF/dt (typical values).

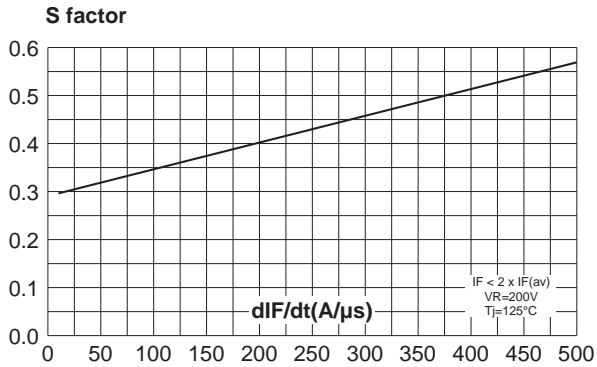

Fig. 8: Relative variation of dynamic parameters versus junction temperature (Reference: Tj=125°C).

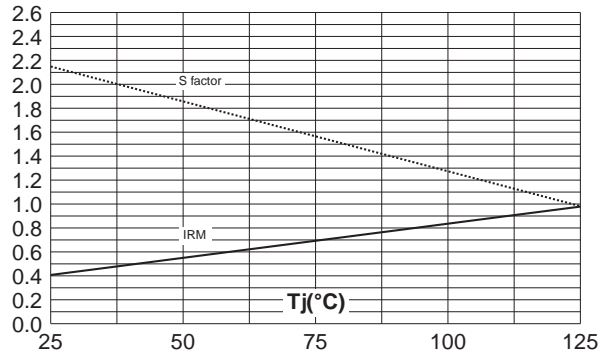

Fig. 9: Transient peak forward voltage versus dIF/dt (90% confidence).

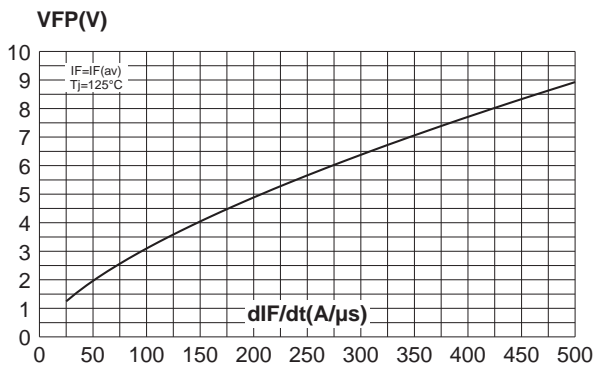

Fig. 10: Forward recovery time versus dIF/dt (90% confidence).

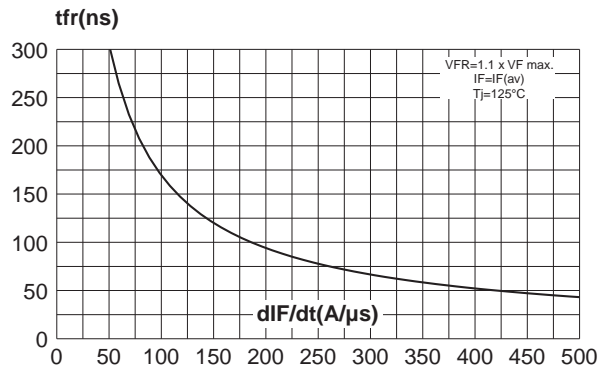
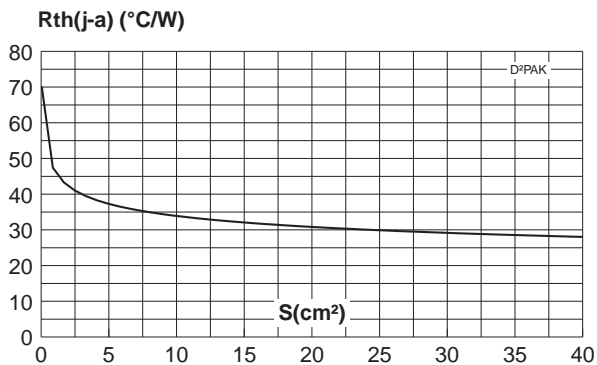
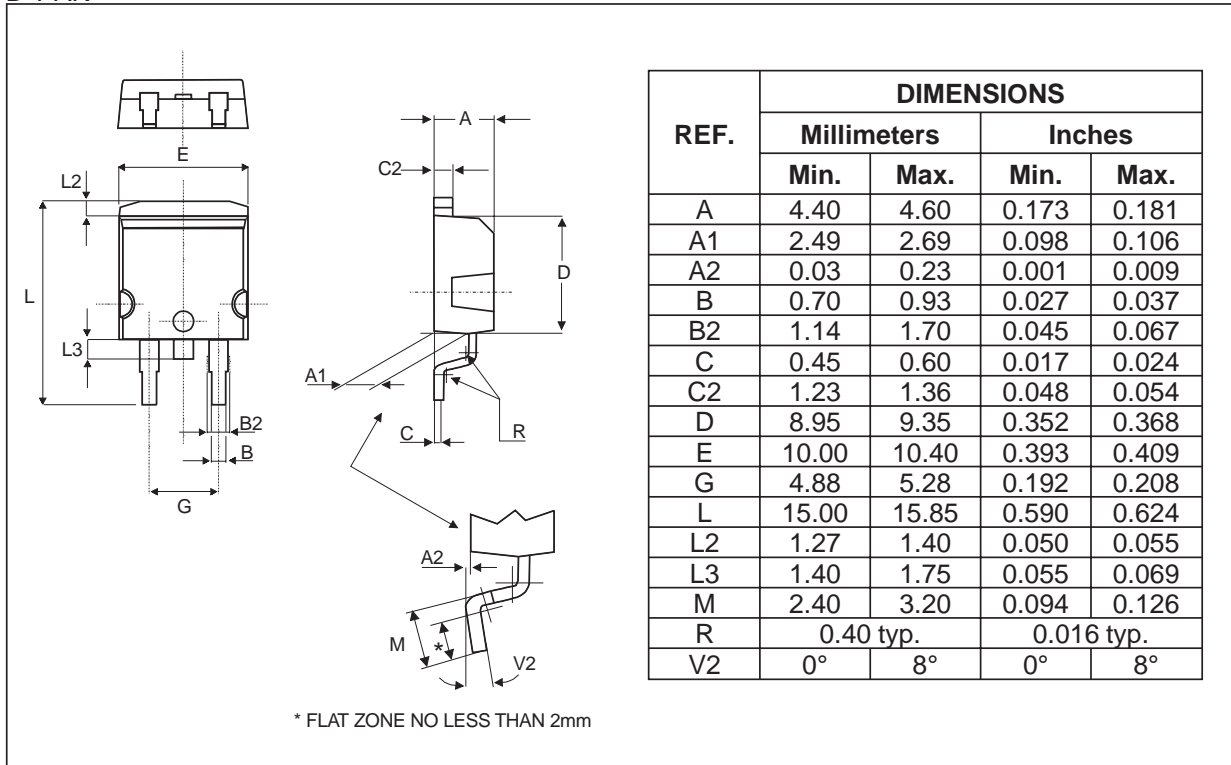

Fig. 11: Thermal resistance junction to ambient versus copper surface under tab (Epoxy printed circuit board FR4, copper thickness: 35μm)(D²PAK)



PACKAGE MECHANICAL DATA

D²PAK



FOOTPRINT

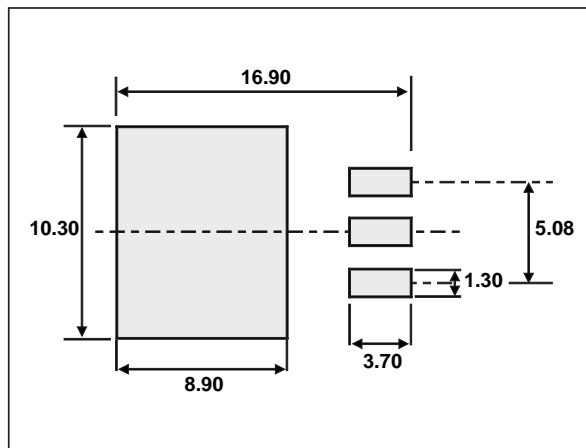

STTH8R03G/D

PACKAGE MECHANICAL DATA

TO-220AC

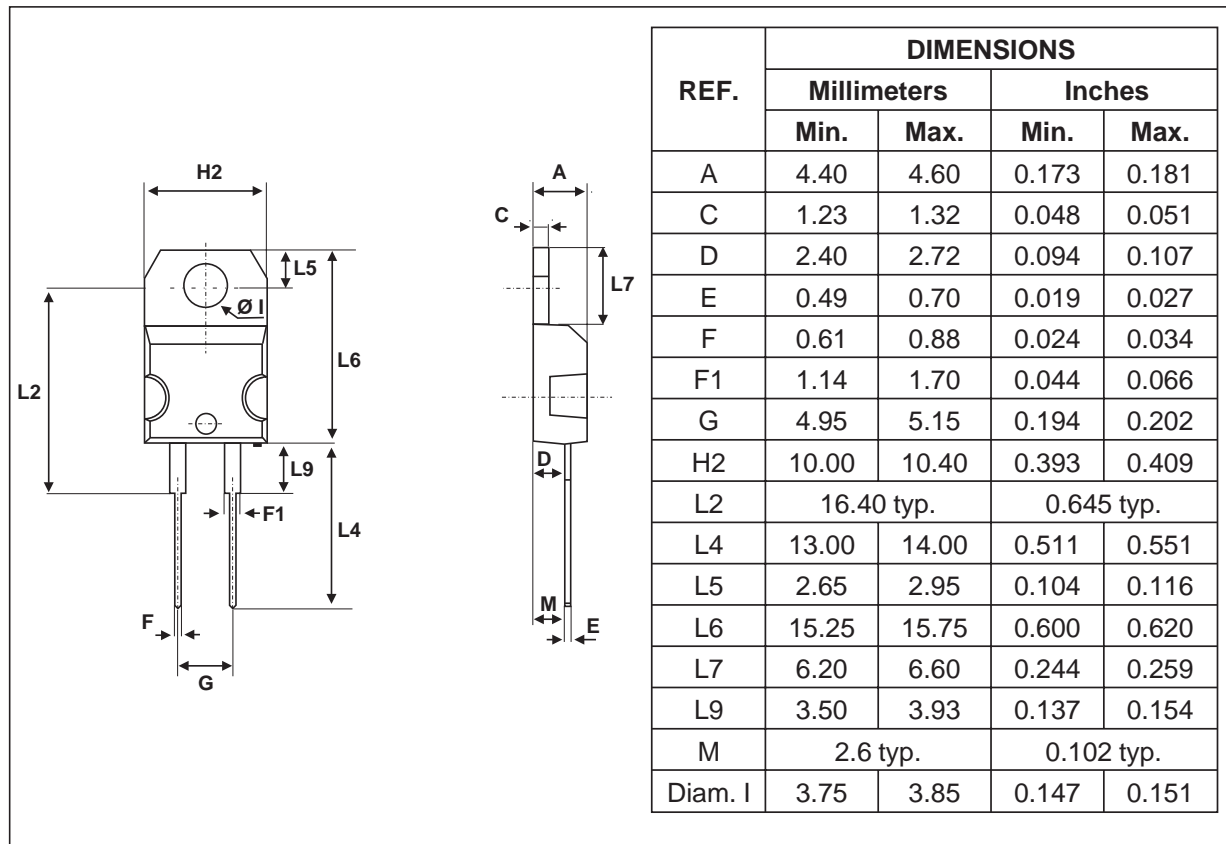

Ordering code	Marking	Package	Weight	Base qty	Delivery mode
STTH8R03D	STTH8R03D	TO-220AC	1.86g	50	Tube
STTH8R03G	STTH8R03G	D ² PAK	1.48g	50	Tube
STTH8R03G-TR	STTH8R03G	D ² PAK	1.48g	1000	Tape & Reel

- Cooling method: by conduction (C)
- Recommended torque value (TO-220AC): 0.55 N.m.
- Maximum torque value (TO-220AC): 0.7 N.m.
- Epoxy meets UL 94,V0

Information furnished is believed to be accurate and reliable. However, STMicroelectronics assumes no responsibility for the consequences of use of such information nor for any infringement of patents or other rights of third parties which may result from its use. No license is granted by implication or otherwise under any patent or patent rights of STMicroelectronics. Specifications mentioned in this publication are subject to change without notice. This publication supersedes and replaces all information previously supplied. STMicroelectronics products are not authorized for use as critical components in life support devices or systems without express written approval of STMicroelectronics.

The ST logo is a registered trademark of STMicroelectronics

© 2001 STMicroelectronics - Printed in Italy - All rights reserved.

STMicroelectronics GROUP OF COMPANIES

Australia - Brazil - China - Finland - France - Germany - Hong Kong - India - Italy - Japan - Malaysia
Malta - Morocco - Singapore - Spain - Sweden - Switzerland - United Kingdom - U.S.A.

<http://www.st.com>