

CS1600 120W, High-efficiency PFC Demonstration Board

Features

- Line Voltage Range: 108 to 305 VACrms
- Output Voltage (V_{LINK}): 460V
- Rated P_{out} : 115W
- Efficiency: 95% @ 115W
- Spread Spectrum Switching Frequency
- Integrated Digital Feedback Control
- Low Component Count

General Description

The CDB1600-120W board demonstrates the performance of the CS1600 digital PFC controller as a stand-alone unit. This board is 95% efficient at full load, and has been tailored for use with a resonant second stage to power up to two T5 fluorescent lamps for a maximum output power of 108W. A resonant second stage driver efficiency of 94% is assumed for this application.

ORDERING INFORMATION

CDB1600-120W Customer Demonstration Board

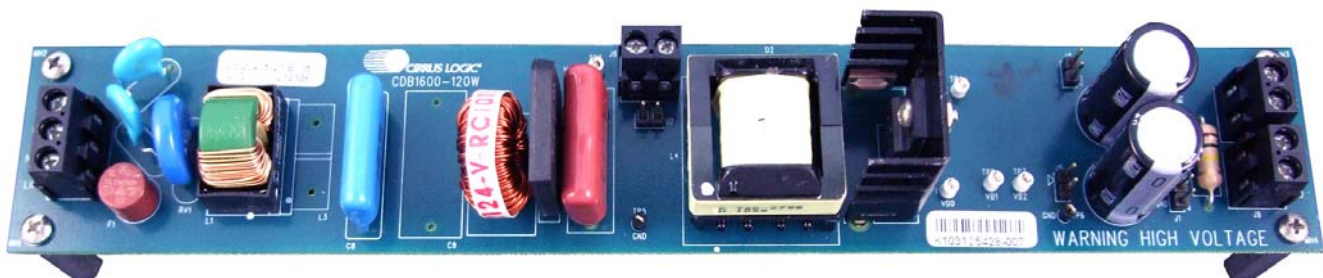

Actual Size:
223 mm x 38 mm
8.75 in x 1.5 in

 **IMPORTANT SAFETY INSTRUCTIONS**

Read and follow all safety instructions prior to using this demonstration board.

This Engineering Evaluation Unit or Demonstration Board must only be used for assessing IC performance in a laboratory setting. This product is not intended for any other use or incorporation into products for sale.

This product must only be used by qualified technicians or professionals who are trained in the safety procedures associated with the use of demonstration boards.

 **DANGER Risk of Electric Shock**

- The direct connection to the AC power line and the open and unprotected boards present a serious risk of electric shock and can cause serious injury or death. Extreme caution needs to be exercised while handling this board.
- Avoid contact with the exposed conductor or terminals of components on the board. High voltage is present on exposed conductor and it may be present on terminals of any components directly or indirectly connected to the AC line.
- Dangerous voltages and/or currents may be internally generated and accessible at various points across the board.
- Charged capacitors store high voltage, even after the circuit has been disconnected from the AC line.
- Make sure that the power source is off before wiring any connection. Make sure that all connectors are well connected before the power source is on.
- Follow all laboratory safety procedures established by your employer and relevant safety regulations and guidelines, such as the ones listed under, OSHA General Industry Regulations - Subpart S and NFPA 70E.

 **WARNING** Suitable eye protection must be worn when working with or around demonstration boards. Always comply with your employer's policies regarding the use of personal protective equipment.

 **WARNING** All components, heat sinks or metallic parts may be extremely hot to touch when electrically active.

 **WARNING** Heatsinking is required for Q1. The end product should use tar pitch or an equivalent compound for this purpose. For lab evaluation purposes, a fan is recommended to provide adequate cooling.

Contacting Cirrus Logic Support

For all product questions and inquiries contact a Cirrus Logic Sales Representative. To find the one nearest to you go to www.cirrus.com

IMPORTANT NOTICE

Cirrus Logic, Inc. and its subsidiaries ("Cirrus") believe that the information contained in this document is accurate and reliable. However, the information is subject to change without notice and is provided "AS IS" without warranty of any kind (express or implied). Customers are advised to obtain the latest version of relevant information to verify, before placing orders, that information being relied on is current and complete. All products are sold subject to the terms and conditions of sale supplied at the time of order acknowledgment, including those pertaining to warranty, indemnification, and limitation of liability. No responsibility is assumed by Cirrus for the use of this information, including use of this information as the basis for manufacture or sale of any items, or for infringement of patents or other rights of third parties. This document is the property of Cirrus and by furnishing this information, Cirrus grants no license, express or implied under any patents, mask work rights, copyrights, trademarks, trade secrets or other intellectual property rights. Cirrus owns the copyrights associated with the information contained herein and gives consent for copies to be made of the information only for use within your organization with respect to Cirrus integrated circuits or other products of Cirrus. This consent does not extend to other copying such as copying for general distribution, advertising or promotional purposes, or for creating any work for resale.

CERTAIN APPLICATIONS USING SEMICONDUCTOR PRODUCTS MAY INVOLVE POTENTIAL RISKS OF DEATH, PERSONAL INJURY, OR SEVERE PROPERTY OR ENVIRONMENTAL DAMAGE ("CRITICAL APPLICATIONS"). CIRRUS PRODUCTS ARE NOT DESIGNED, AUTHORIZED OR WARRANTED FOR USE IN PRODUCTS SURGICALLY IMPLANTED INTO THE BODY, AUTOMOTIVE SAFETY OR SECURITY DEVICES, LIFE SUPPORT PRODUCTS OR OTHER CRITICAL APPLICATIONS. INCLUSION OF CIRRUS PRODUCTS IN SUCH APPLICATIONS IS UNDERSTOOD TO BE FULLY AT THE CUSTOMER'S RISK AND CIRRUS DISCLAIMS AND MAKES NO WARRANTY, EXPRESS, STATUTORY OR IMPLIED, INCLUDING THE IMPLIED WARRANTIES OF MERCHANTABILITY AND FITNESS FOR PARTICULAR PURPOSE, WITH REGARD TO ANY CIRRUS PRODUCT THAT IS USED IN SUCH A MANNER. IF THE CUSTOMER OR CUSTOMER'S CUSTOMER USES OR PERMITS THE USE OF CIRRUS PRODUCTS IN CRITICAL APPLICATIONS, CUSTOMER AGREES, BY SUCH USE, TO FULLY INDEMNIFY CIRRUS, ITS OFFICERS, DIRECTORS, EMPLOYEES, DISTRIBUTORS AND OTHER AGENTS FROM ANY AND ALL LIABILITY, INCLUDING ATTORNEYS' FEES AND COSTS, THAT MAY RESULT FROM OR ARISE IN CONNECTION WITH THESE USES.

Cirrus Logic, Cirrus, and the Cirrus Logic logo designs are trademarks of Cirrus Logic, Inc. All other brand and product names in this document may be trademarks or service marks of their respective owners.

1. INTRODUCTION

The CS1600 is a high-performance Variable Frequency Discontinuous Conduction Mode (VF-DCM), active Power Factor Correction (PFC) controller, optimized to deliver the lowest PFC system cost for electronic ballast applications. The CS1600 uses a digital control algorithm that is optimized for high efficiency and near unity power factor over a wide input voltage range (108-305 VAC).

The CS1600 uses an adaptive digital control algorithm. Both the ON time and the switching frequency are varied on a cycle-by-cycle basis over the entire AC line to achieve close to unity power factor. The variation in switching frequency also provides a spread frequency spectrum, thus minimizing the conducted EMI filtering requirements.

The feedback loop is closed through an integrated digital control system within the IC. Protection features such as overvoltage, overcurrent, overpower, open circuit, overtemperature, and brownout help protect the device during abnormal transient conditions. Details of these features are provided in the CS1600 data sheet.

The CDB1600-120W board demonstrates the performance of the CS1600 over a wide input voltage range of 108 to 305 VAC, typically seen in universal input ballast applications. This board has been designed for a 460 V, 115 W full load output application.

Extreme caution needs to be exercised while handling this board. This board is to be powered up by trained professionals only.

Prior to applying AC power to the CDB1600-120W board, the CS1600 needs to be biased using an external 13 VDC power supply, applied across pins 1 and 2 of terminal block J9. Terminal block J6 is used to connect the AC line. The load is connected to J7. As a safety measure, jumper J1 is provided as a means to apply a small resistive load (200 k Ω minimum) to rapidly discharge the output capacitors. Other jumpers and test points are provided to evaluate the behavior of the IC and the various sections of the design.

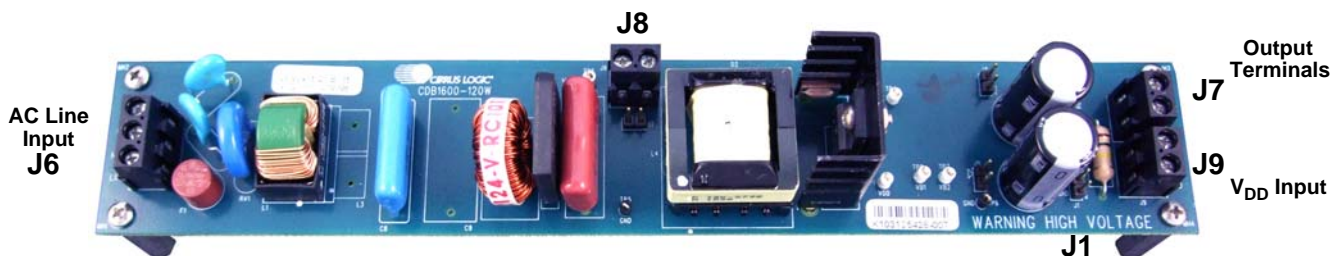

Figure 1. Board Connections

2. SCHEMATIC

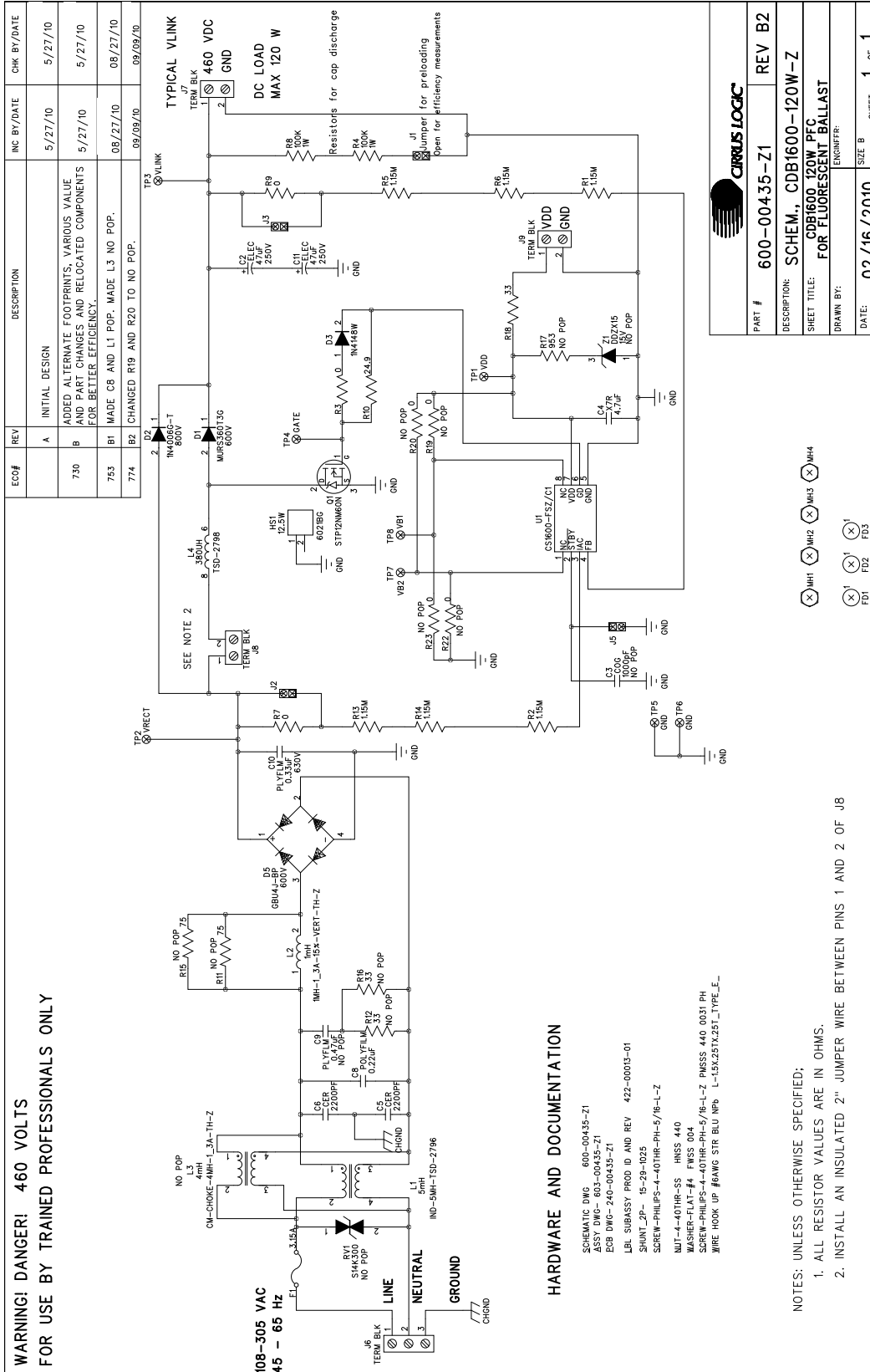

Figure 2. Schematic

3. BILL OF MATERIALS
BILL OF MATERIAL (Page 1 of 2)
**CIRRUS LOGIC
CDB1600-120W_REV_B_6_4_10_1418**

Item	Cirrus PIN	Rev	Description	Qty	Reference Designator	MFG	MFG PIN
1	012-00186-Z1	A	CAP 47UF ±20% 250V ELEC NPb RAD	2	C2 C11	NICHICON	UVZ2E470MHD
2	001-06034-Z1	A	CAP 1000PF ±5% 50V COG NPb 1206	0	C3	KEMET	C1206C102J5GAC
3	001-10233-Z1	A	CAP 4.7UF ±20% 25V X7R NPb 1206	1	C4	TDK	C3216X7R1E475M
4	011-00049-Z1	A	CAP 2200PF ±20% DISC 500V RAD NPb	2	C5 C6	VISHAY	VY1222M47Y5JG63V0
5	011-00055-Z1	A	CAP 0.22uF ±20% 305V PLY FILM NPb TH	1	C8	EPCOS	B32923C3224M
6	013-00031-Z1	A	CAP 0.47uF ±10% 400V POLY NPb RAD	0	C9	WIMA	MKP10-47/400/10P27
7	013-00034-Z1	A	CAP 0.33uF ±10% 630V POLY NPb RAD	1	C10	PANASONIC	ECQE6334KF
8	070-00166-Z1	A	DIODE RECT 600V 4A ULT NPb SMC	1	D1	ON SEMICONDUCTOR	MURS360T3G
9	070-00132-Z1	A	DIODE RECT 800V 1A 200mA NPb DO-41	1	D2	DIODES INC	1N4006G-T
10	070-00007-Z1	A	DIODE FAST SW 75V 350mA NPb SOD123	1	D3	DIODES INC	1N4148W-7-F
11	070-00157-Z1	A	DIODE RECT BRIDGE 600V 4A NPb GBU	1	D5	MICRO COMMERCIAL CO	GBU4J-BP
12	180-00022-Z1	A	FUSE 3.15A TLAG IEC NPb SHORT TR5	1	F1	LITTLE FUSE	37213150411
14	311-00019-Z1	A	HTSNK W LOCK TAB .5" TO220 NPb	1	HS1	AAVID THERMALLOY	6021BG
15	115-00014-Z1	A	HDR 2x1 ML .1" 062BD ST GLD NPb TH	4	J1 J2 J3 J5	SAMTEC	TSW-102-07-G-S
16	110-00301-Z1	A	CON 3POS TERM BLK 5.08mm SPR NPb RA	1	J6	WEIDMULLER	1716030000
17	110-00302-Z1	A	CON 2POS TERM BLK 5.08mm SPR NPb RA	3	J7 J8 J9	WEIDMULLER	1716020000
18	050-00039-Z1	A	XFMR 5mH 1:1 1500Vrms 4PIN NPb TH	1	L1	PREMIER MAGNETICS	TSD-2796
19	040-00127-Z1	A	IND 1mH 1.3A ±15% TOR VERT NPb TH	1	L2	BOURNS	2124-V-RC
20	050-00047-Z1	A	XFMR COMMON MODE CHOKE 1.3 A TH NPb	0	L3	RENCO	RL-4400-2-4.00
21	050-00041-Z1	A	XFMR 380uH .30 500Vrms 8PIN NPb TH	1	L4	PREMIER MAGNETICS	TSD-2798
22	304-00001-Z1	A	SPCR STANDOFF 4-40 THR .875L AL NPb	4	MH1 MH2 MH3 MH4	KEYSTONE	1809
23	070-00165-Z1	A	TRAN MOSFET nCH 10A 600V NPb TO220	1	Q1	ST	STP12NM60N
24	020-06356-Z1	A	RES 1.15M OHM 1/4W ±1% NPb 1206	6	R1 R2 R5 R6 R13 R14	MICROELECTRONICS	CRCW12061M15FKEA
25	020-02273-Z1	A	RES 0 OHM 1/4W NPb 1206 FILM	3	R3 R7 R9	DALE	CRCW12060000Z0EA
26	030-00080-Z1	A	RES 100K 1W ±5% MTL FILM NPb AXL	2	R4 R8	XICON	294-100K-RC
27	020-06337-Z1	A	RES 24.9 OHM 1/4W ±1% NPb 1206 FILM	1	R10	DALE	CRCW120624R9FKEA
28	020-02488-Z1	A	RES 75 OHM 1/4W ±1% NPb 1206 FILM	0	R11 R15	DALE	CRCW120675R0FKEA
29	021-00544-Z1	A	RES 33 OHM 1/4W ±5% NPb 1206 FILM	0	R12 R16	DALE	CRCW120633R0JNEA
30	020-01014-Z1	A	RES 953 OHM 1/10W ±1% NPb 0603 FILM	0	R17	DALE	CRCW0603953R3FKEA
31	021-00375-Z1	A	RES 33 OHM 1/8W ±5% NPb 0805 FILM	1	R18	DALE	CRCW080533R0JNEA
32	020-02273-Z1	A	RES 0 OHM 1/4W NPb 1206 FILM	0	R19 R20 R22 R23	DALE	CRCW12060000Z0EA
33	036-00015-Z1	A	VARIATOR 470V RMS 14MM NPb RAD	0	RV1	EPCOS	S14K300
34	110-00025-Z1	A	CON TEST PT .1" TIN PLATE WHT NPb	6	TP1 TP2 TP3 TP4 TP7 TP8	KEYSTONE	5002
35	110-00045-Z1	A	CON TEST PT .1"CTR TIN PLAT NPb BLK	2	TP5 TP6	KEYSTONE	5001
36	065-00319-Z2	C1	IC CRUS PFC CNTR BALLAST NPb SOIC8	1	U1	CIRRUS LOGIC	CS1600-FSZ/C1
37	300-00025-Z1	A	SCREW 4-40X5/16" PH MACH SS NPb	5	XXMH1 XXMH2 XXMH3 XXMH4 XHS1	BUILDING FASTENERS	PMSSS 440 0031 PH
38	070-00170-Z1	A	DIODE ZEN SGL 300MW 15V NPb SOT23	0	Z1	DIODES INC	DDZX15
39	603-00435-Z1	B	ASSY DWG CDB1600-120W	REF		CIRRUS LOGIC	603-00435-Z1
40	422-00013-01	B	LBL SUBASSY PRODUCT ID AND REV	1		CIRRUS LOGIC	422-00013-01
41	240-00435-Z1	B	PCB CDB1600-120W-Z-NPb	1		CIRRUS LOGIC	240-00435-Z1
42	600-00435-Z1	B2	SCHEM CDB1600-120W	REF		CIRRUS LOGIC	600-00435-Z1
43	110-00013-Z1	D	CON SHUNT 2P .1"CTR BLK NPb	0	XJ1 XJ2 XJ3 XJ5	MOLEX	15-29-1025
44	302-00007-Z1	A	NUT STEEL 4-40THR HEX SS NPb	1	XHS1	KEYSTONE	HNS5 440

BILL OF MATERIAL (Page 2 of 2)
**CIRRUS LOGIC
CDB1600-120W_REV_B_6_4_10_1418**

Item	Cirrus P/N	Rev	Description	Qty	Reference Designator	MFG	MFG P/N
45	301-00013-Z1	A	WSHR FLAT #4 NPb SS	1	XHS1	BUILDING FASTENERS	FWSS 004
46	080-00003-Z1	A	WIRE BPOST 1.5X.25 24/19 GA BLU NPb	1	XJ8	SQUIRES	L- 1.5X.25TX.25T_TYPE_ E

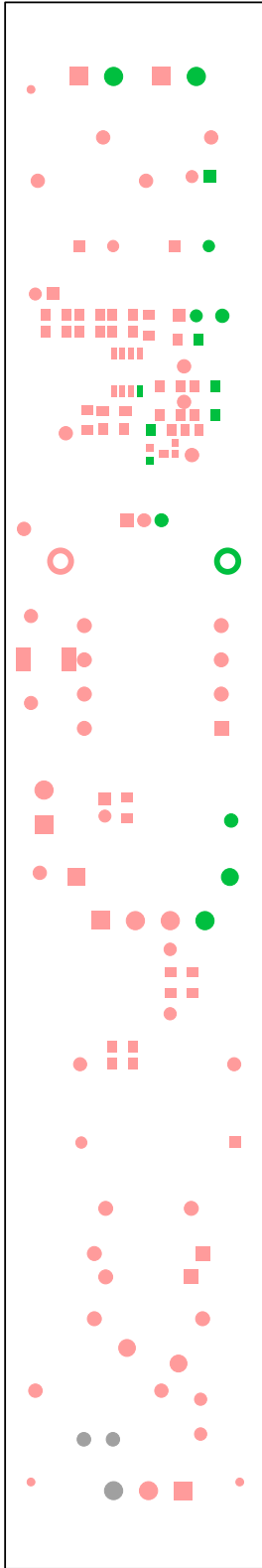
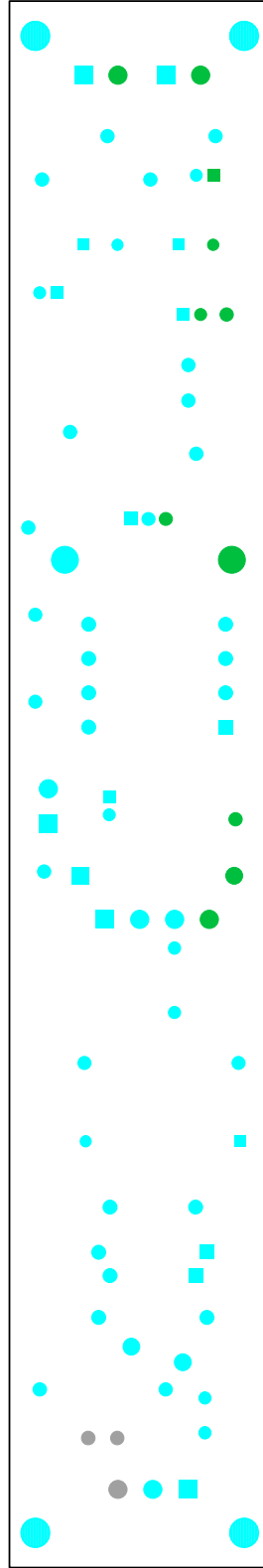
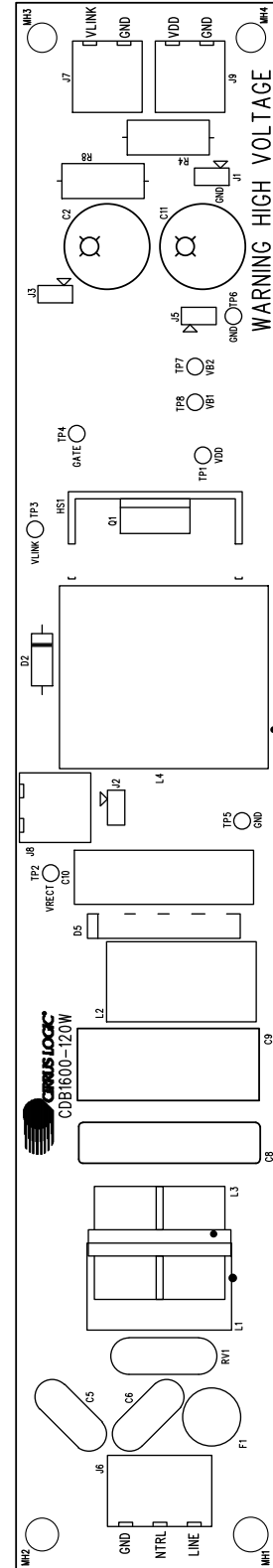
4. BOARD LAYOUT

Figure 3. Solder Mask (Bottom)

Figure 4. Solder Mask (Top)

Figure 5. Silkscreen (Top)

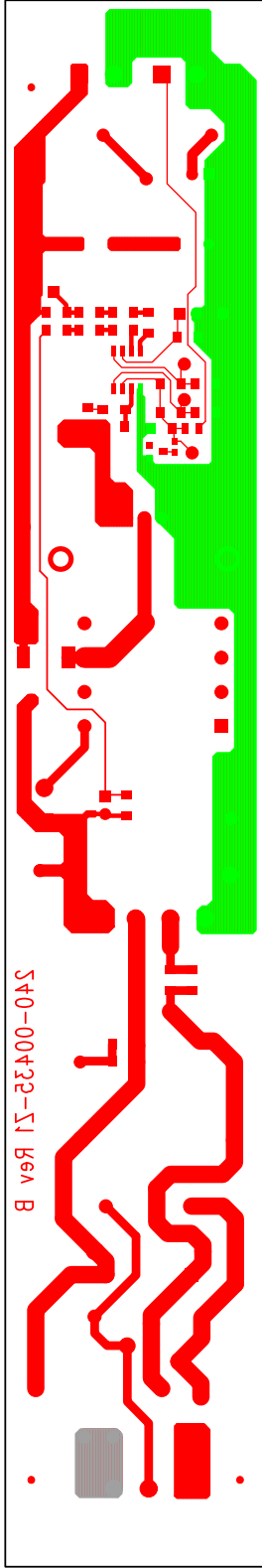

Figure 6. Circuit Routing (Bottom)

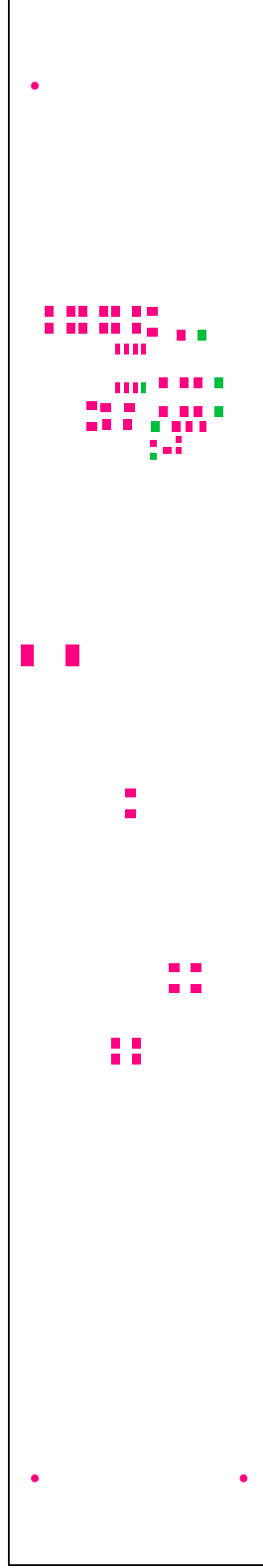

Figure 7. Solder Paste Mask (Bottom)

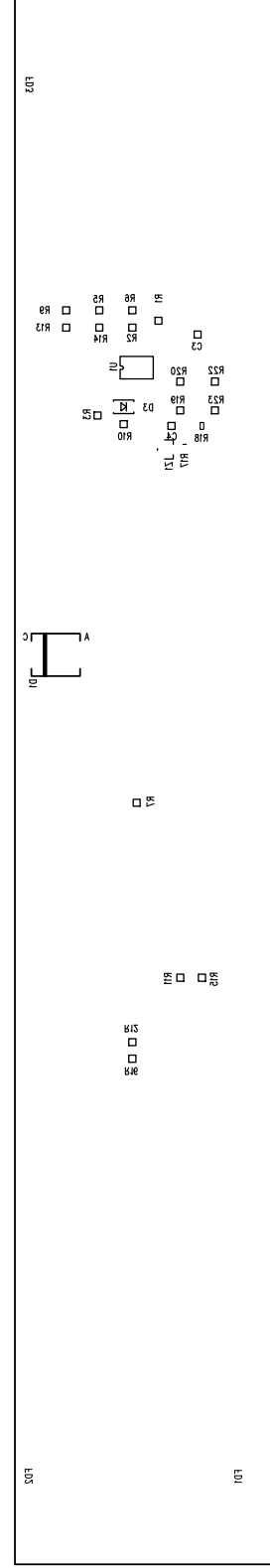
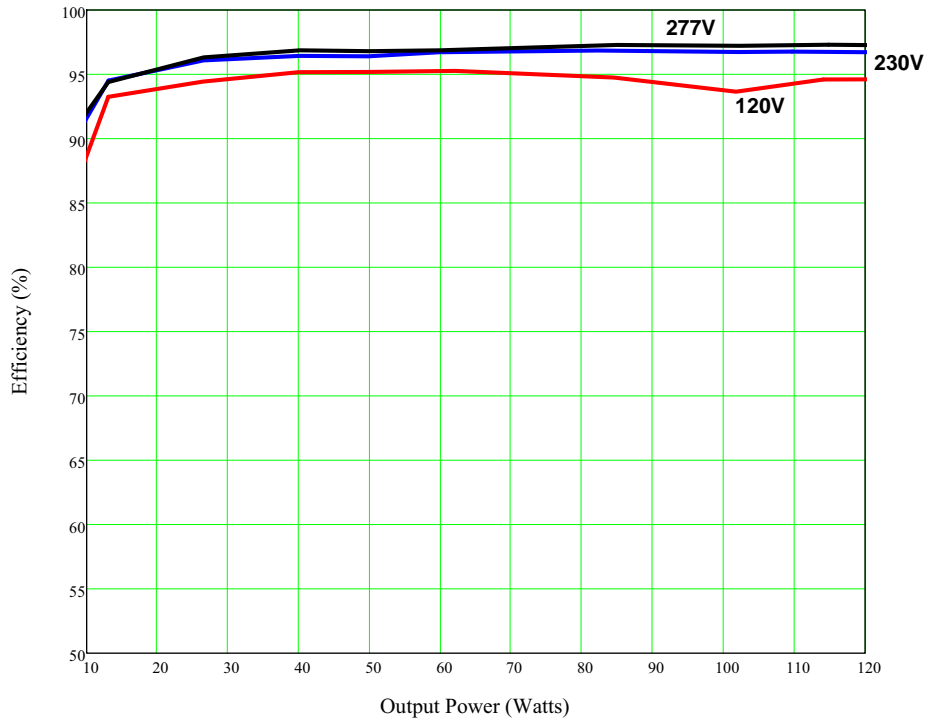
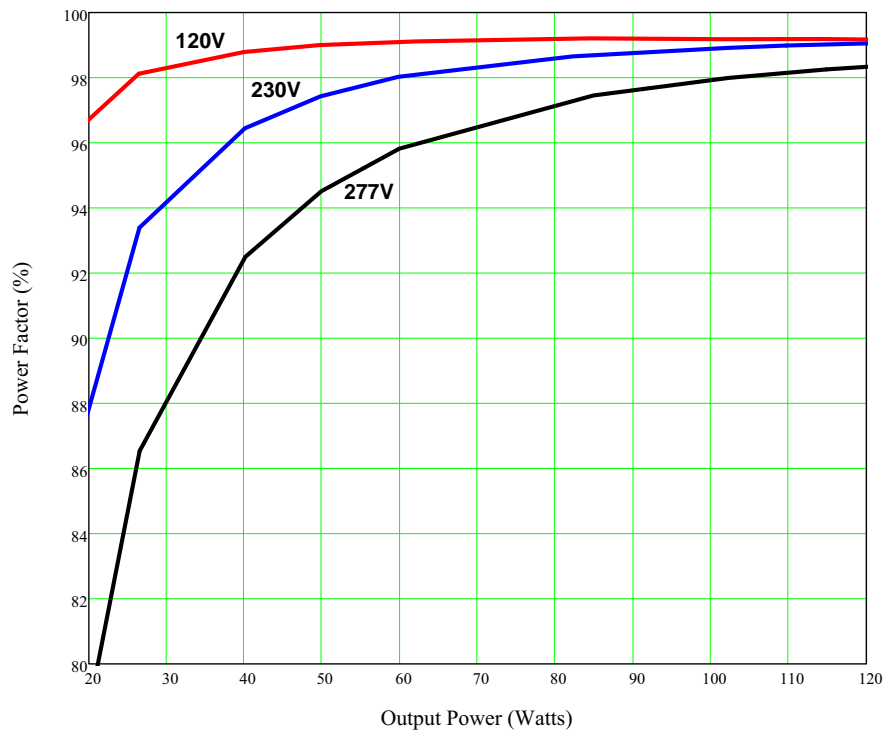

Figure 8. Silkscreen (Bottom)

5. TYPICAL PERFORMANCE PLOTS

Figure 9. Efficiency vs. Output Power

Figure 10. Power Factor vs. Output Power

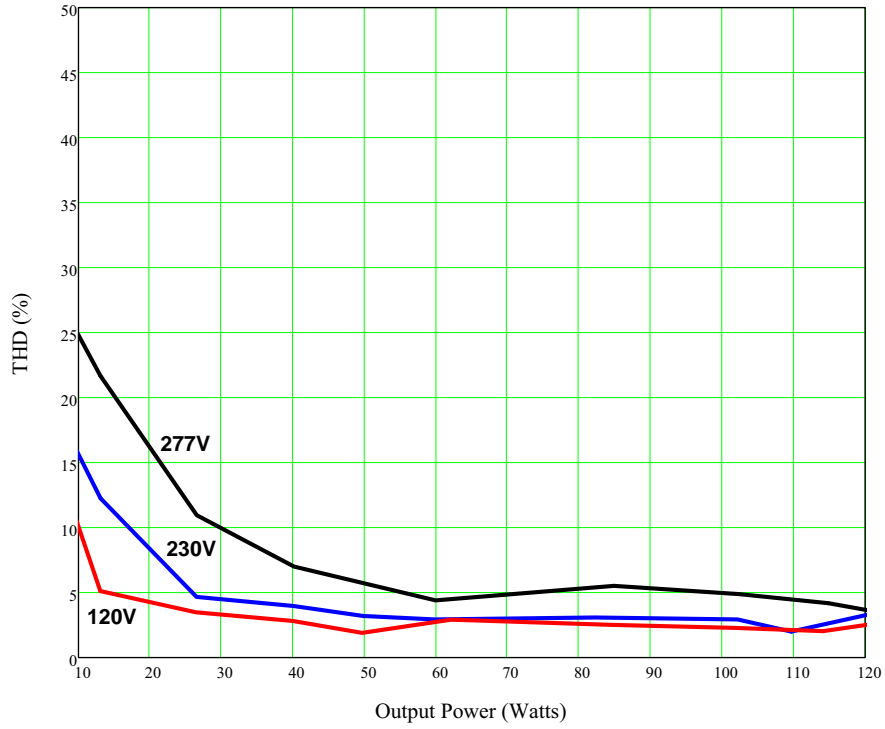

Figure 11. THD vs. Output Power

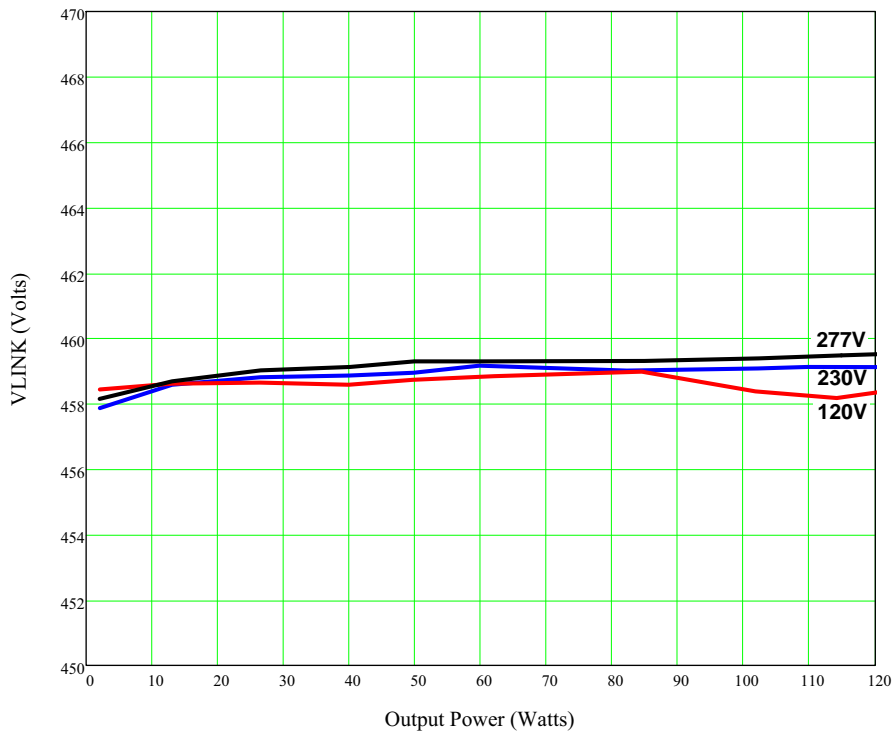
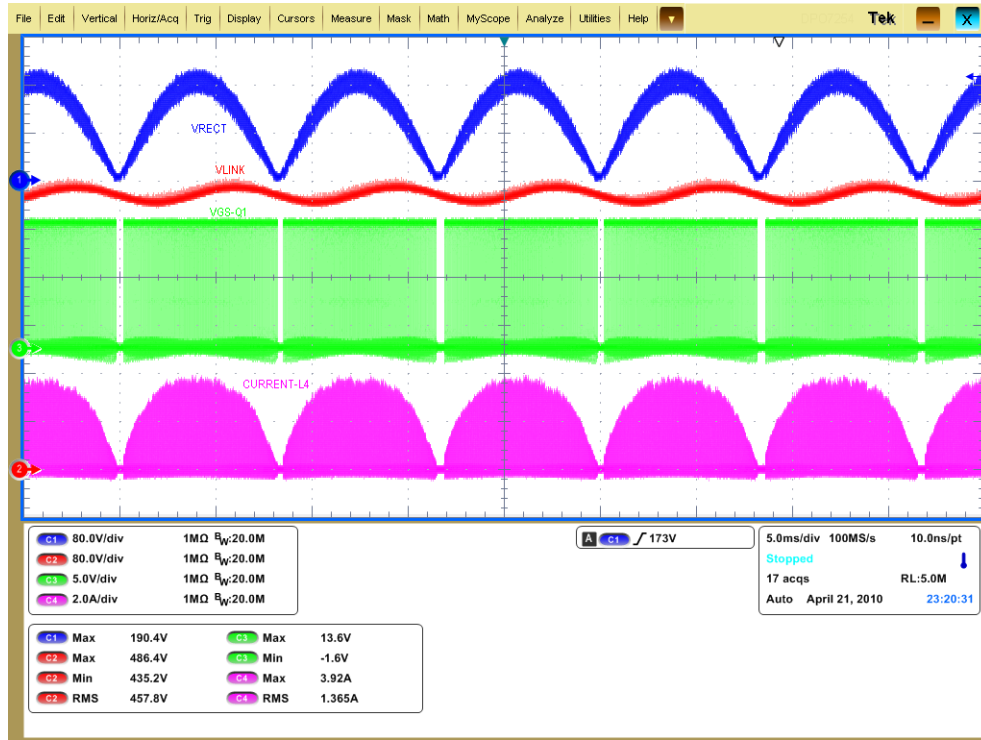
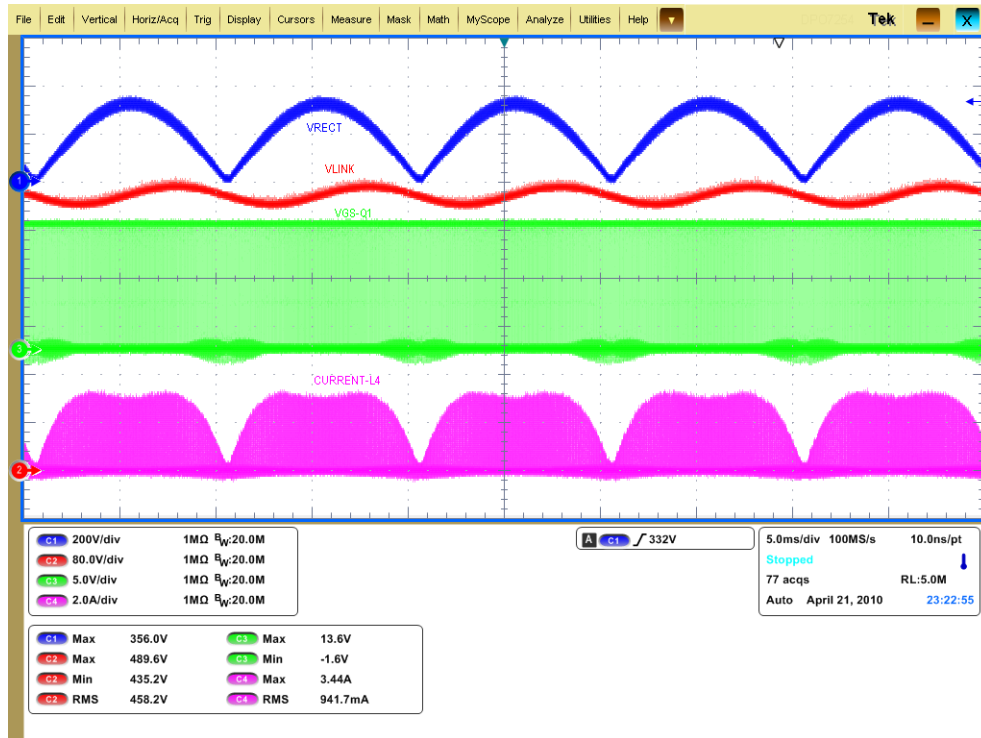

Figure 12. V_{link} Voltage vs. Output Power

Figure 13. Steady State Waveforms — 120 VAC

Figure 14. Steady State Waveforms — 230 VAC

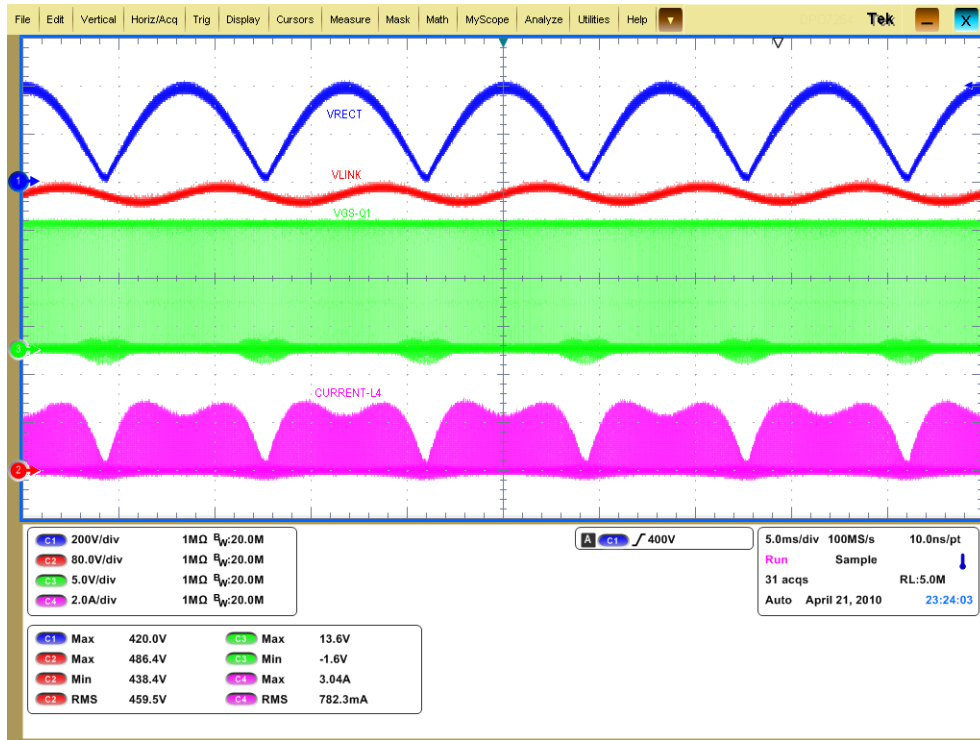

Figure 15. Steady State Waveforms — 277 VAC

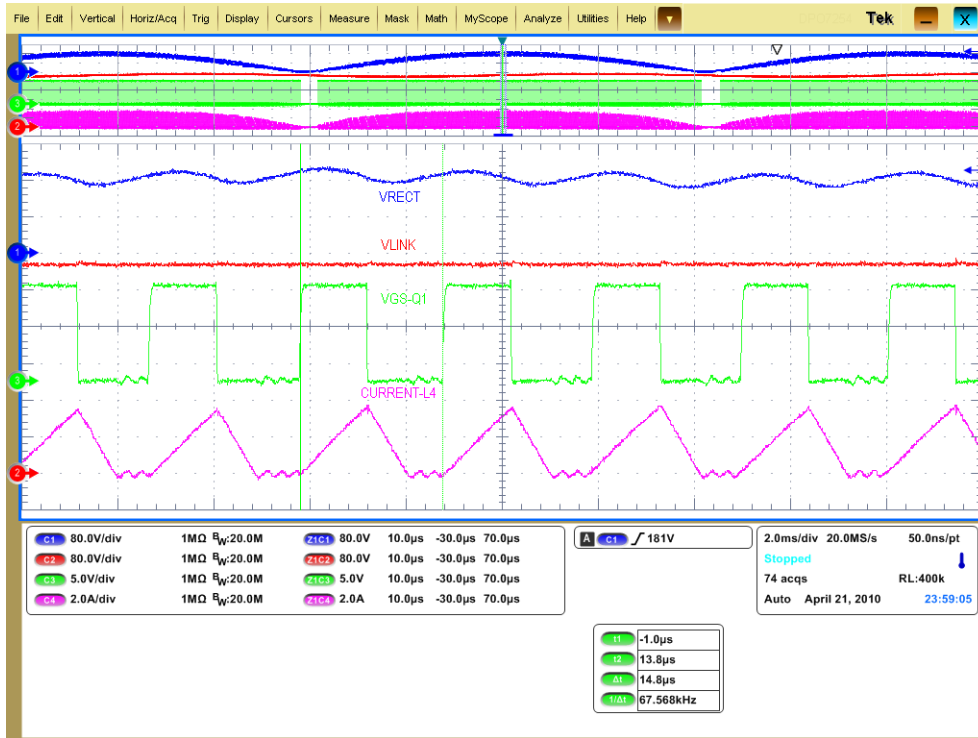

Figure 16. Switching Frequency Profile at Peak of AC Line Voltage — 120 VAC

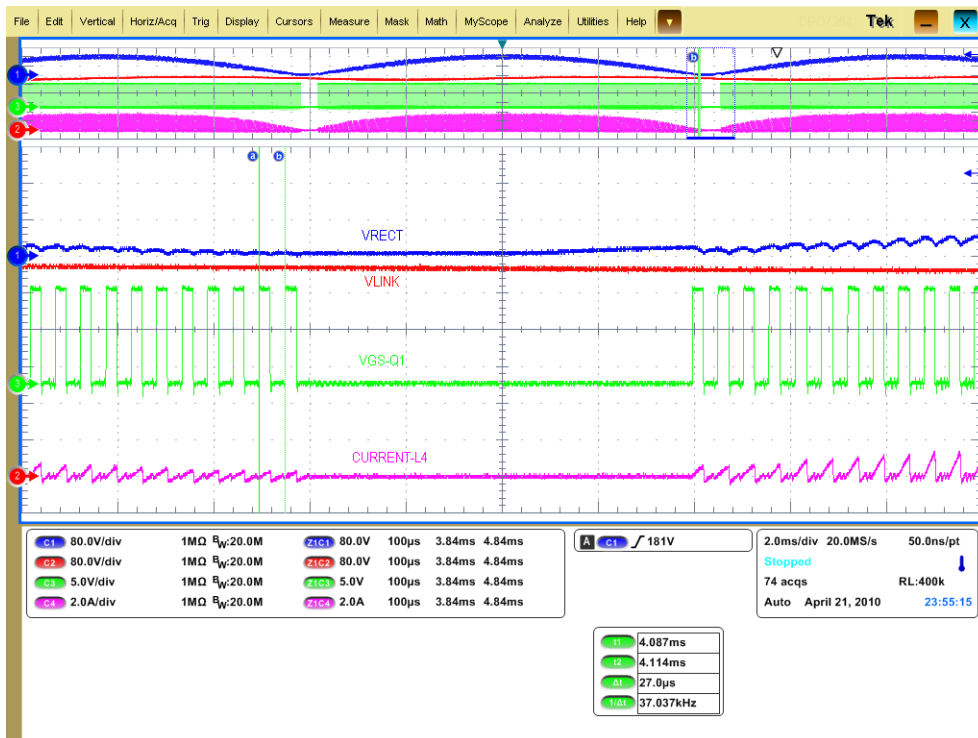

Figure 17. Switching Frequency Profile at Trough of AC Line Voltage — 120 VAC

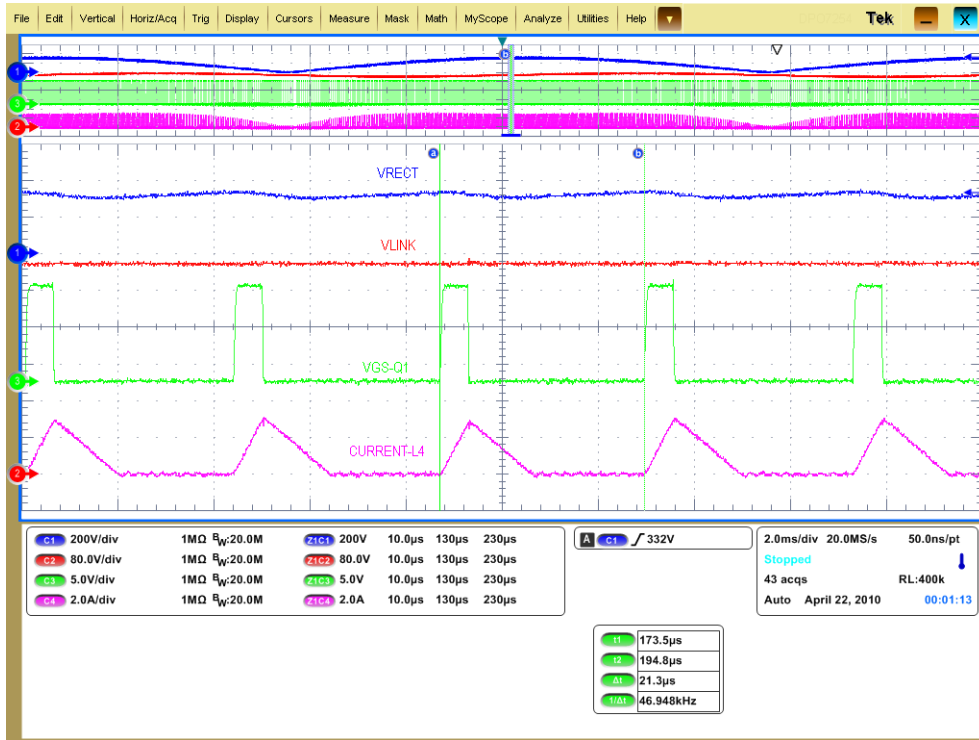

Figure 18. Switching Frequency Profile at Peak of AC Line Voltage — 230 VAC

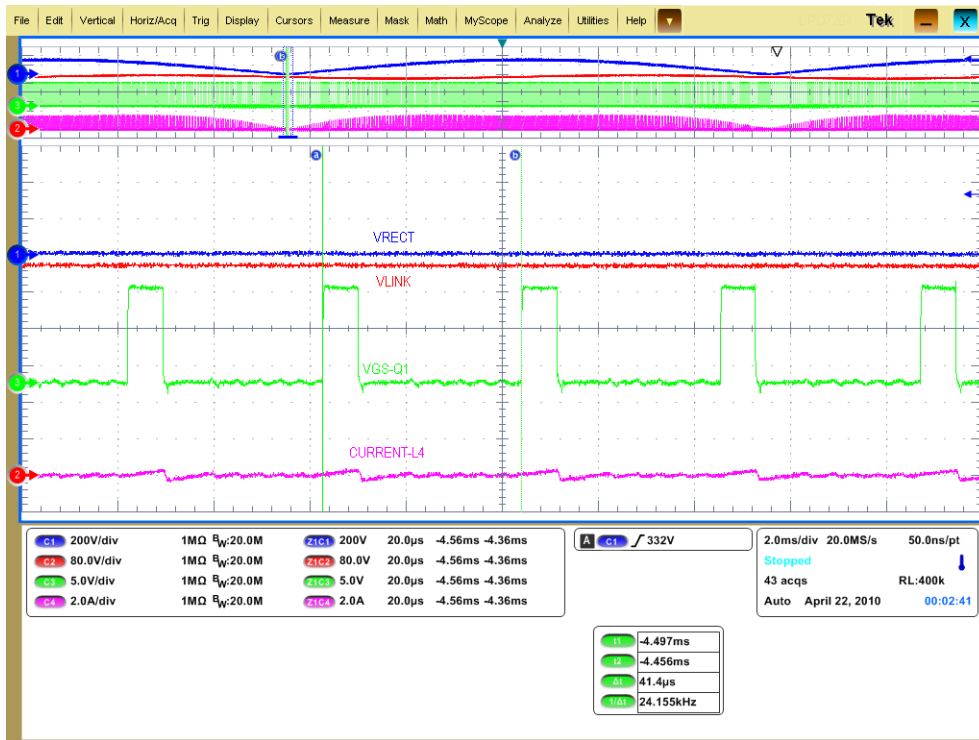

Figure 19. Switching Frequency Profile at Trough of AC Line Voltage — 230 VAC



Figure 20. Switching Frequency Profile at Peak of AC Line Voltage — 277 VAC

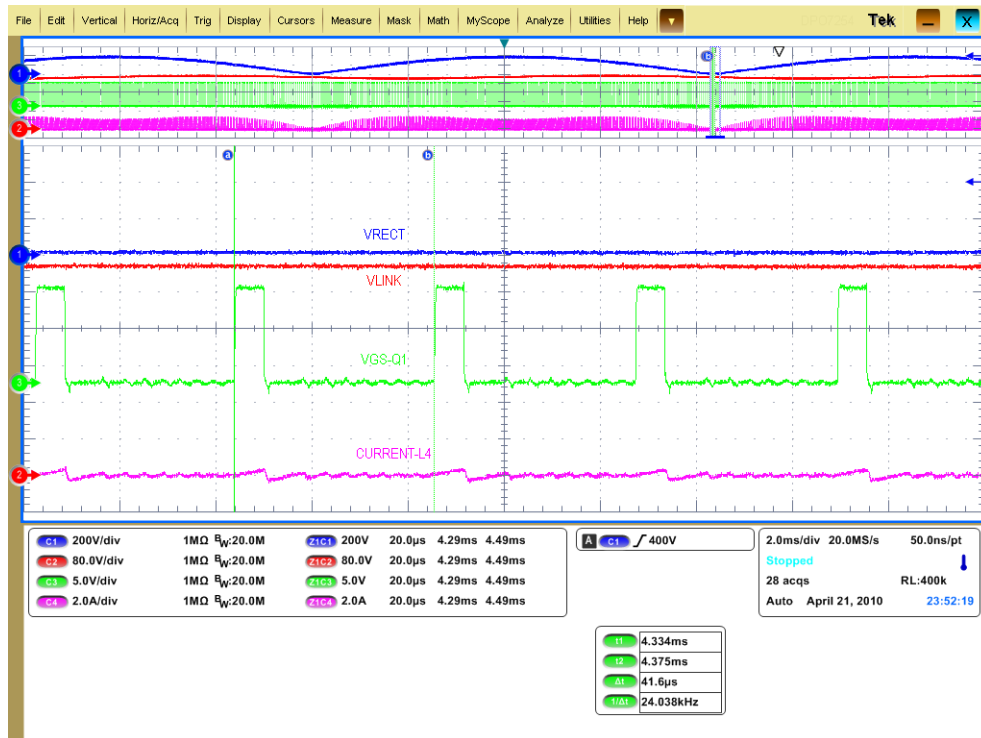

Figure 21. Switching Frequency Profile at Trough of AC Line Voltage — 277 VAC

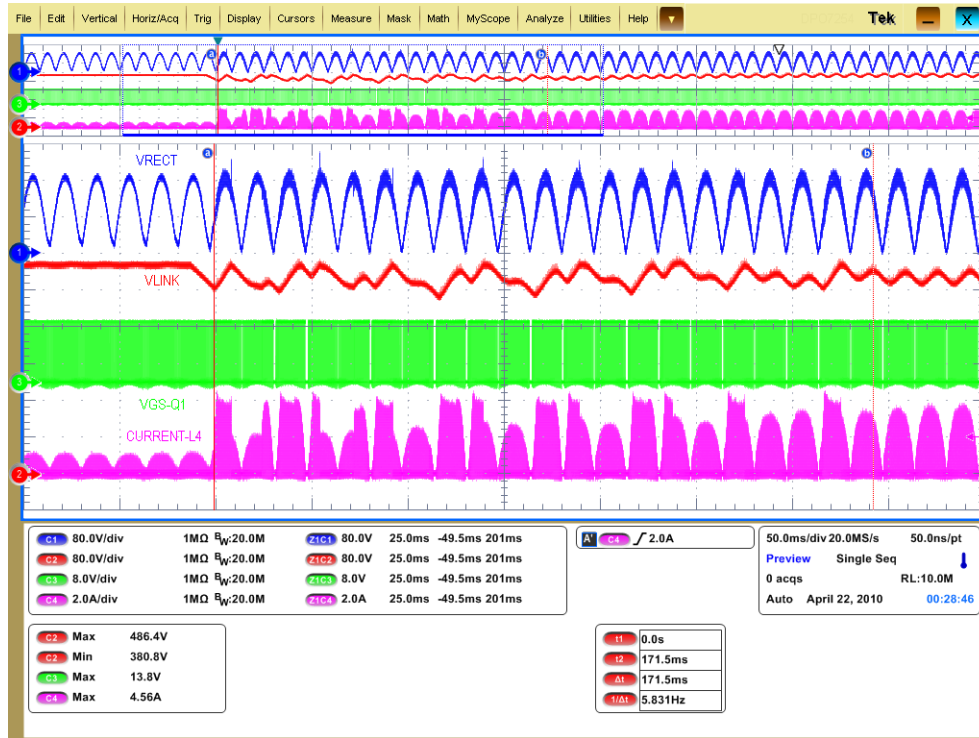

Figure 22. Transient — 10W to 115W Load at 10W/μs, Vin = 120VAC

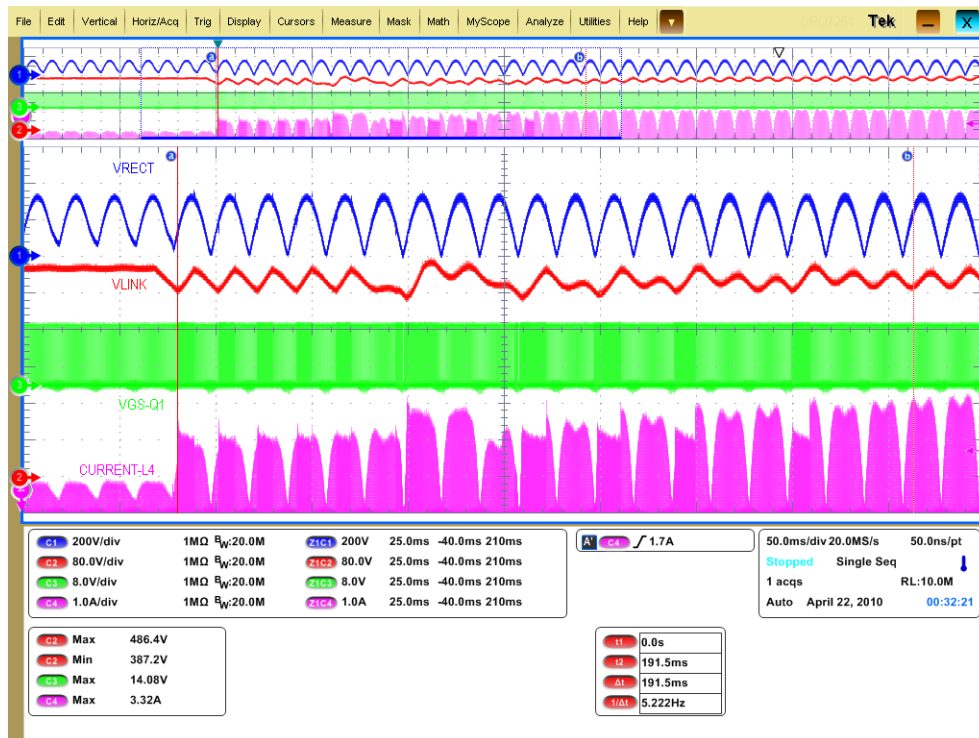

Figure 23. Transient — 10W to 115W Load at 10W/μs, Vin = 230VAC

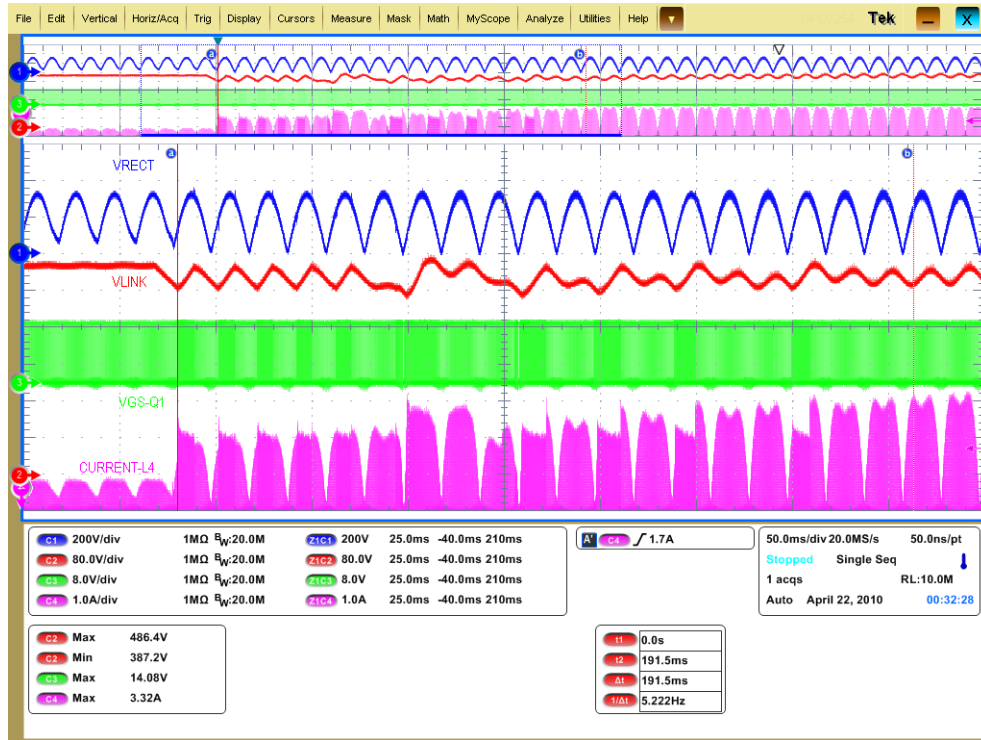

Figure 24. Transient — 10W to 115W Load at 10W/μs, Vin = 230VAC

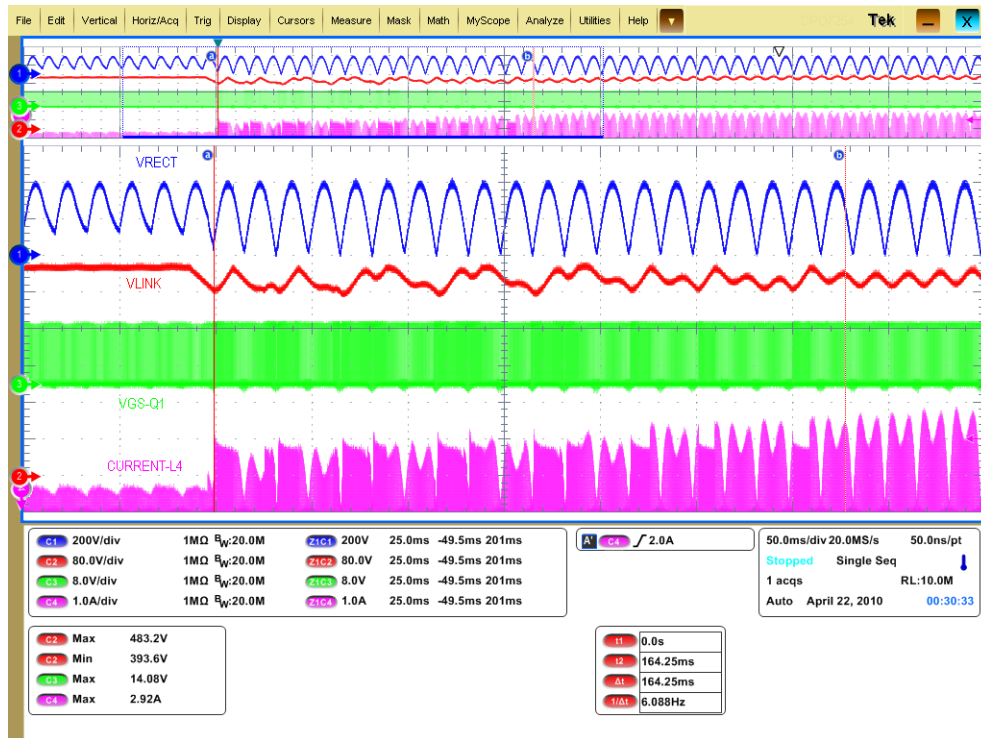

Figure 25. Transient — 10W to 115W Load at 10W/μs, Vin = 277VAC

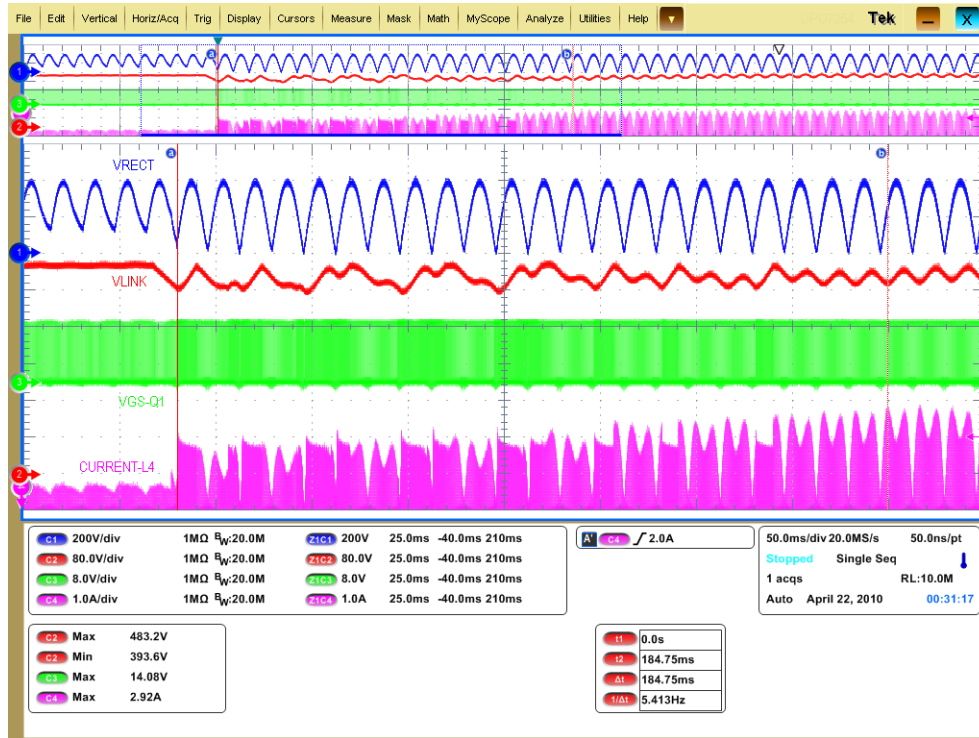

Figure 26. Transient — 10W to 115W Load at 10W/μs, Vin = 277VAC

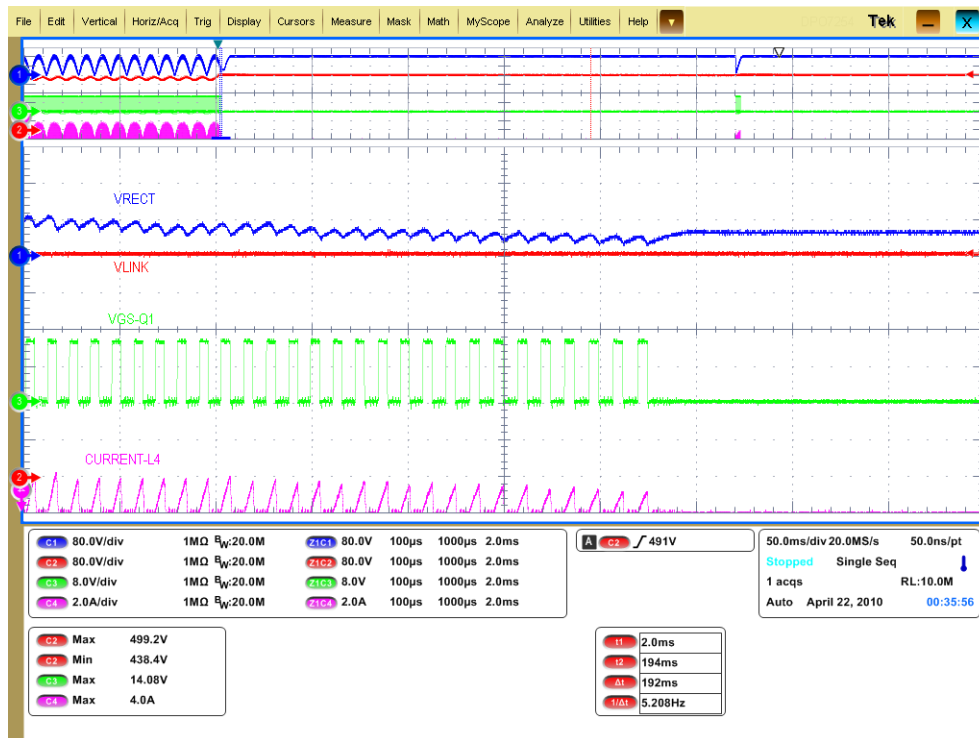

Figure 27. Transient — 115W to Zero Load at 10W/μs, Vin = 120VAC

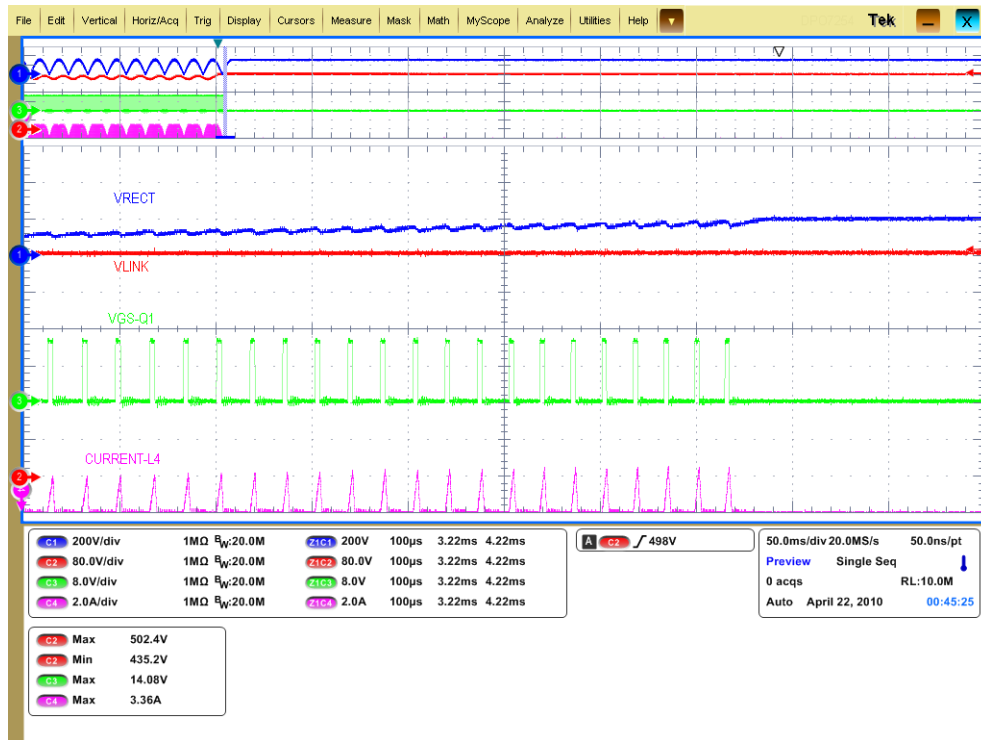

Figure 28. Transient — 115W to Zero Load at 10W/μs, Vin = 230VAC



Figure 29. Transient — 115W to Zero Load at 10W/μs, Vin = 277VAC

6. REVISION HISTORY

Revision	Date	Changes
DB1	APR 2010	Initial Release.
DB2	MAY 2010	Updated for rev C1 silicon. Added Fig 22-29.
DB3	JUL 2010	Updated with Rev B schematic, BOM, and layer plots.
DB4	NOV 2010	Updated with Rev B2 schematic, BOM, and layer plots.