

MGA-412P8

GaAs Enhancement-mode pHEMT Power Amplifier
optimized for IEEE 802.11b/g applications



Data Sheet

Description

Avago Technologies's MGA-412P8 linear power amplifier is designed for applications in the (1.7-3) GHz frequency range. The amplifier is optimized for IEEE 802.11b/g WLAN applications and has a best-in-class efficiency (PAE) of 25.5% (54Mbps OFDM) achieved through the use of Avago Technologies' proprietary GaAs Enhancement-mode pHEMT process.

The MGA-412P8 is housed in a miniature 2.0 x 2.0 x 0.75mm³ 8-lead leadless-plastic-chip-carrier (LPCC) package. The compact footprint, low profile and excellent thermal efficiency of the LPCC package makes the MGA-412P8 an ideal choice as a power amplifier for mobile IEEE 802.11b/g WLAN applications.

It achieves +19.0 dBm linear output power that meets 3% EVM at 54Mbps data rate (OFDM Modulation), and 23dBm at 11Mbps (CCCK modulation).

Component Image

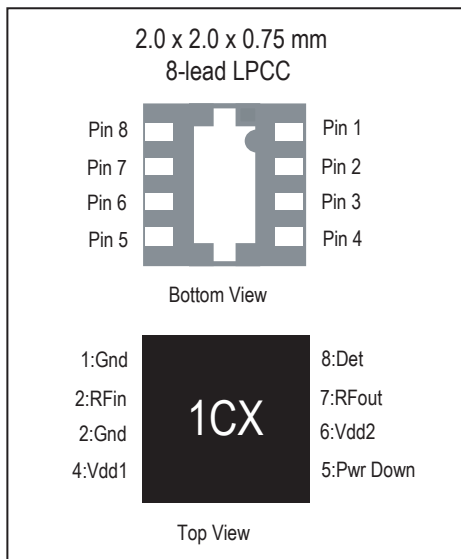

Note:
Package marking provides Orientation and Identification
"1C" = Product Code
"X" = Date code indicates month of manufacture

Features

- Advanced GaAs E-pHEMT
- Integrated power detector & power down functions
- High efficiency
- Single +3.3V Supply
- Small Footprint: 2x2mm²
- Low Profile: 0.8mm max.

Specifications

- At 2.452 GHz; 3.3V (Typ.) :
- Gain: 25.5 dB
- P1dB: 25.3 dBm
- Pout linear with IEEE 802.11g OFDM modulation @54Mbps data rate: 19.0 dBm @ 3% EVM.
- Current @19dBm linear Pout: (54Mbps) : 95mA
- Reverse Isolation (typ): > 40dB
- Quiescent current (typ): 40mA
- Meets IEEE 802.11b @11Mbps (CCCK modulation) with Pout: 23dBm while consuming 200mA.

Applications

- Power Amplifier for IEEE 802.11b/g WLAN applications
- Bluetooth Power Amplifier
- 2.4GHz ISM band applications



Attention: Observe precautions for handling electrostatic sensitive devices.

ESD Machine Model = 50 V
ESD Human Body Model = 200 V
Refer to Avago Technologies Application Note A004R: *Electrostatic Discharge, Damage and Control.*

Absolute Maximum Rating^[1] Tc=25°C

Symbol	Parameter	Units	Absolute Max.
V _{dd}	Device Voltage, RF output to ground	V	5
P _{in}	CW RF Input Power (V _{dd} = 3.3V)	dBm	10
P _{diss}	Total Power Dissipation ^[2]	W	0.8
T _j	Junction Temperature	°C	150
T _{STG}	Storage Temperature	°C	-65 to 150

Thermal Resistance^[3] (V_{dd} = 3.3V), θ_{jc} = 33.3 °C/W

Notes:

1. Operation of this device in excess of any of these limits may cause permanent damage.
2. Board (package belly) temperature, T_b is 25 °C. Derate 30mW/°C for T_b>123.36 °C.
3. Thermal resistance measured using 150 °C Liquid Crystal Measurement Technique.

Product Consistency Distribution Charts^[4,5]

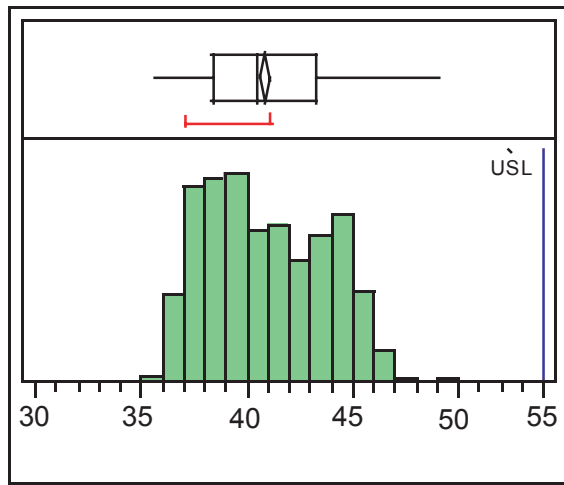

Figure 1. Id@ 2.452GHz; Nominal = 40mA, USL: 55mA

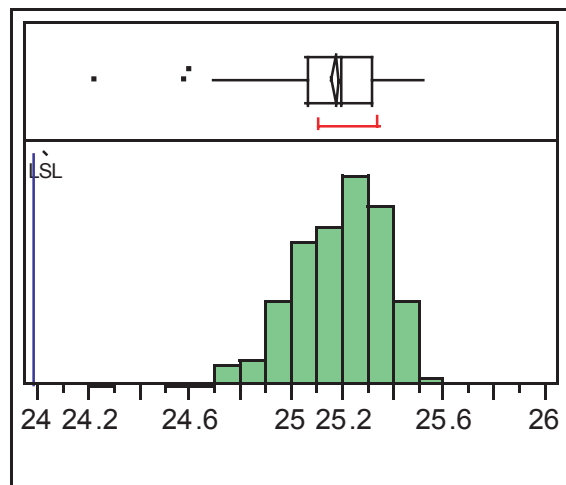

Figure 2. P1dB @ 2.452GHz; Nominal = 25.3dBm, LSL: 24dBm

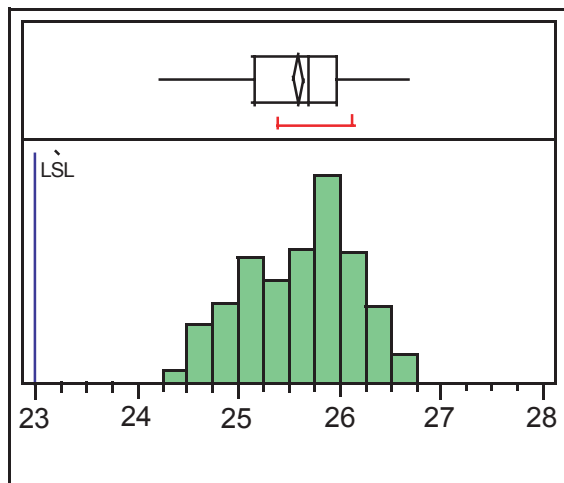

Figure 3. Gain@ 2.452GHz; Nominal = 25.5dB, LSL: 23 dB

Notes:

4. Distribution data sample size is 500 samples taken from 3 different wafers and 3 different lots. Future wafers allocated to this product may have nominal values anywhere between the upper and lower limits.
5. Measurements are made on production test board, which represents a trade-off between optimal Gain and P1dB. Circuit losses have been de-embedded from actual measurements.

Electrical Specifications [6]

T_c = 25 °C, 2.452 GHz [typical, measured on demo board]. DC bias for RF parameters V_{dd} = V_{sd} = 3.3V

Unless otherwise specified, all data are taken with OFDM 64-QAM modulated signal per IEEE802.11g specifications at 54Mbps data rate.

Symbol	Parameter	Units	MIN	TYP	MAX
I _{dq}	Quiescent current	mA		40	55
I _{sd}	Current drawn by Shutdown pin	mA		0.5	
I _{leak}	Total current consumption at shutdown(V _{sd} =0V)	uA		5	
G	Gain	dB	23	25.5	
P _{sat}	Saturated Power	dBm		27	
P _{1dB}	1 dB Compression Point	dBm	24	25.3	
	Gain Flatness (2.4 - 2.5GHz)	dB		1	
P _{outn}	Max P _{out} per IEEE 802.11b mask (CCCK modulation)	dBm		23	
I _{dn}	Current @ 23dBm 802.11b BPSK	mA		200	
P _{outl}	Linear Power @ 3% EVM, 54Mbps OFDM	dBm		19	
I _{dl}	Current @ 3% EVM	mA		95	
S ₁₁	Input Return Loss	dB		-5.5	
S ₂₂	Output Return Loss	dB		-11.5	
S ₁₂	Isolation	dB		>40	
OIP ₃	Large Signal, Output IP ₃ (2-tone at ± 10MHz from carrier freq)	dBm		38	

Notes:

6. Measurements taken on demo board as shown on Figure 4. Excess circuit losses have been de-embedded from actual measurements. Standard deviation and typical data based on at least 500 parts sample size from 2 wafer lots. Future wafers allocated to this product may have nominal values any where within the upper and lower spec limits.

Demo board Diagram

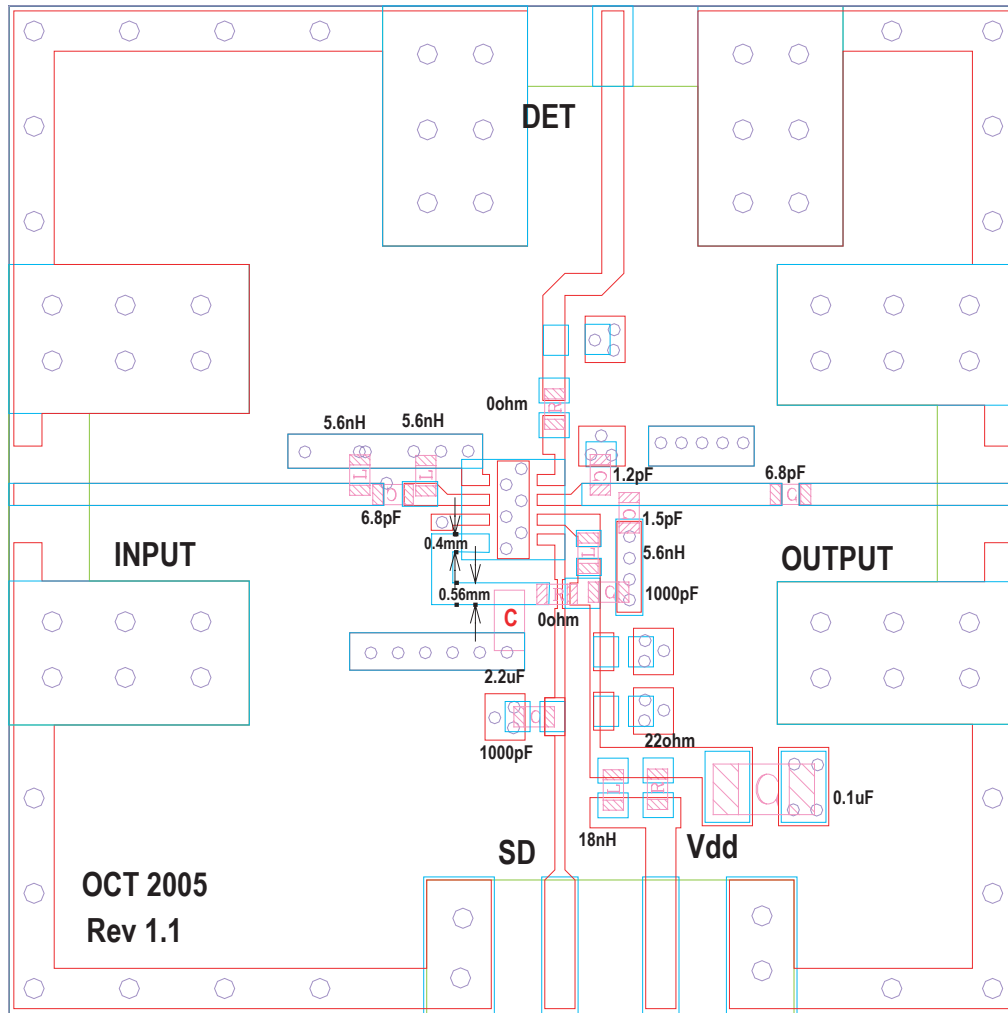

Figure 4. Demo board and Application Circuit Components

Schematic Diagram

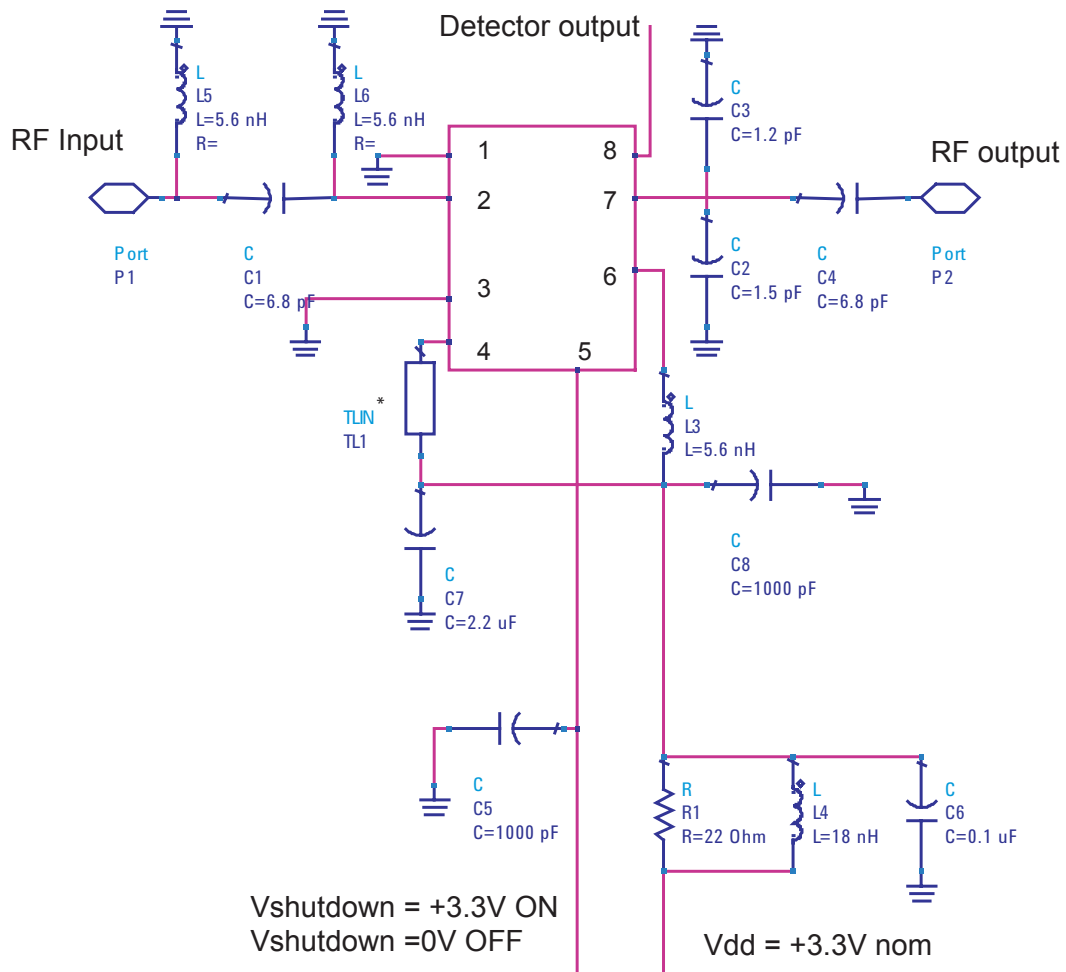

Figure 5. Demo Board Schematic Diagram

- * 0.56mm wide on 10mil thick Rogers RO4350 board
 - Components L6, C2 and C3 should be located as close to the packaged device pins as possible.
 - Components R1 and L4 are used to isolate the test board from Power Supply effects.
 - Recommended PCB material is Roger, RO4350.
 - Suggested component values may vary according to layout and PCB material.

MGA-412P8 Typical Performance I

Tc = +25 °C, Vdd = 3.3V Input Signal=CW unless stated otherwise.

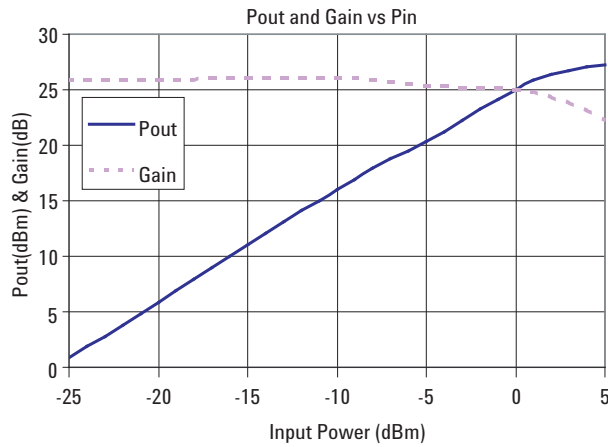

Figure 6. Output Power and Gain vs Input Power

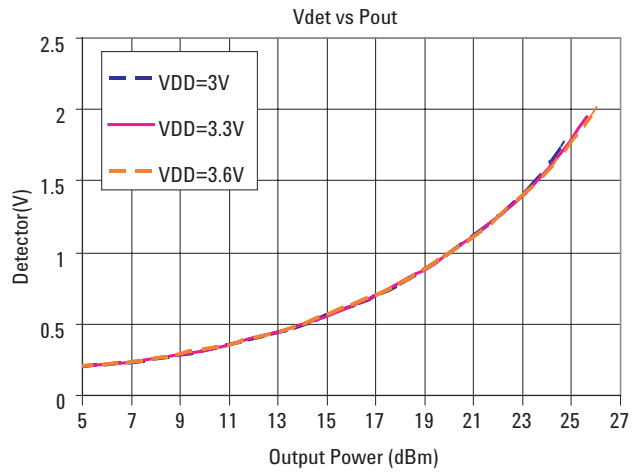

Figure 7. Detector vs Output Power

MGA-412P8 Typical Performance II

Tc = +25 °C, Vdd = 3.3V Input Signal=OFDM signal with 54Mbps, Modulation=64QAM unless stated otherwise.

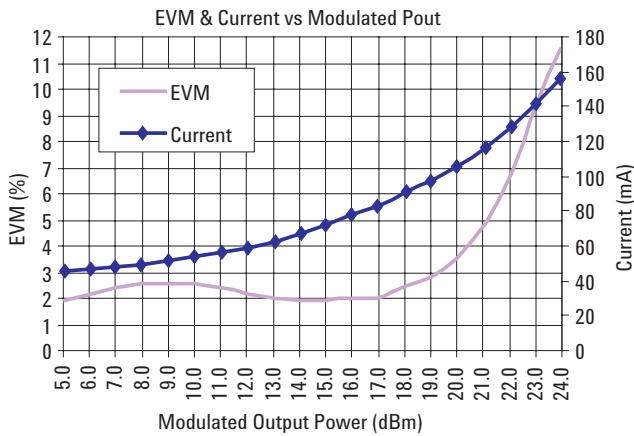

Figure 8. EVM & Current vs Output Power

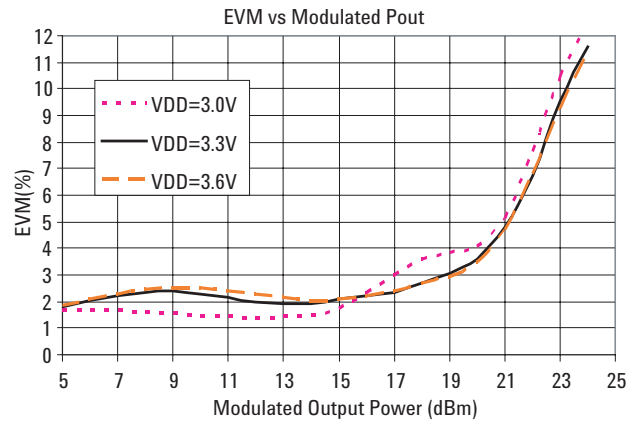

Figure 9. EVM vs Modulated Output Power

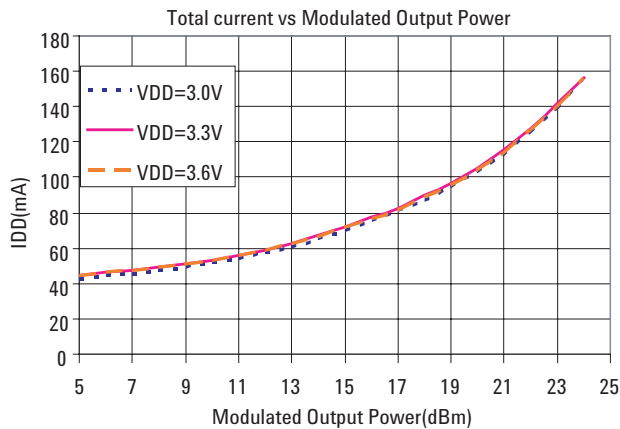

Figure 10. Total Current vs Modulated Output Power

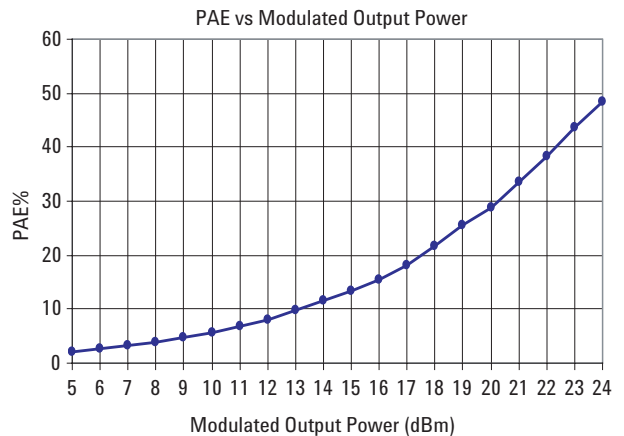

Figure 11. PAE vs Modulated Output Power

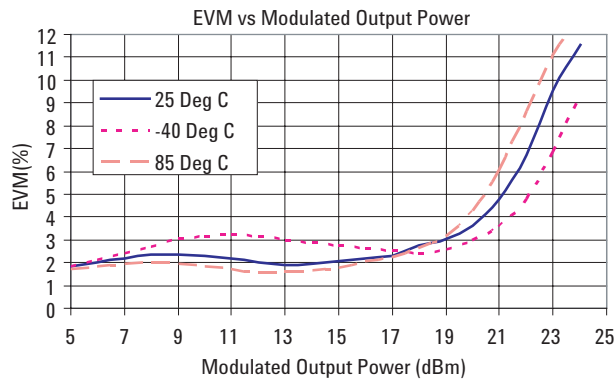

Figure 12. EVM vs Modulated Output Power at different Temperature

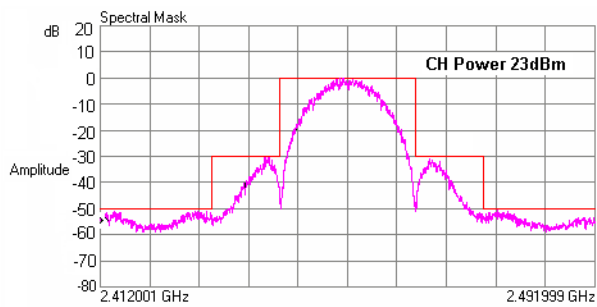

Figure 13. Typical Spectral Plot conforming compliance to IEEE 802.11b 11Mbps CCCK modulation mask at 23dBm output power

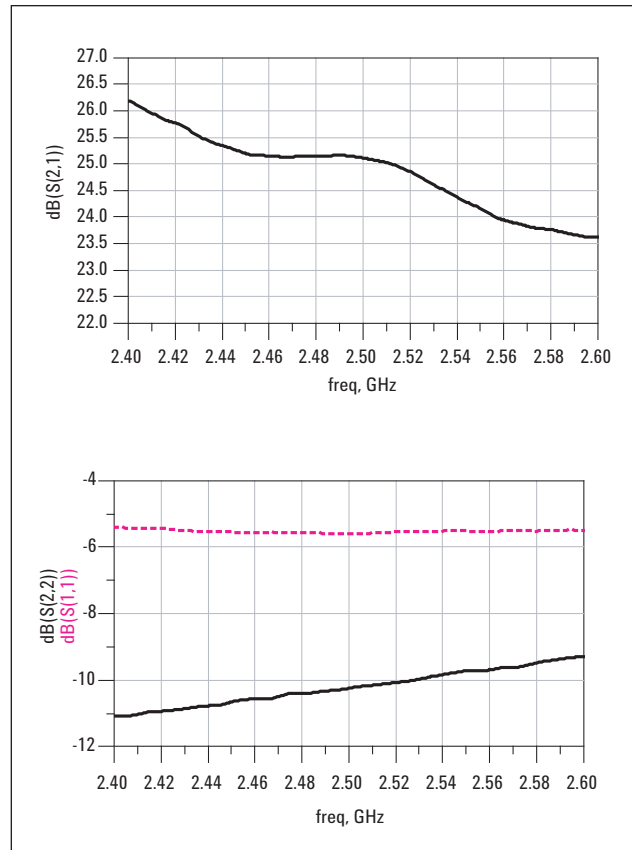
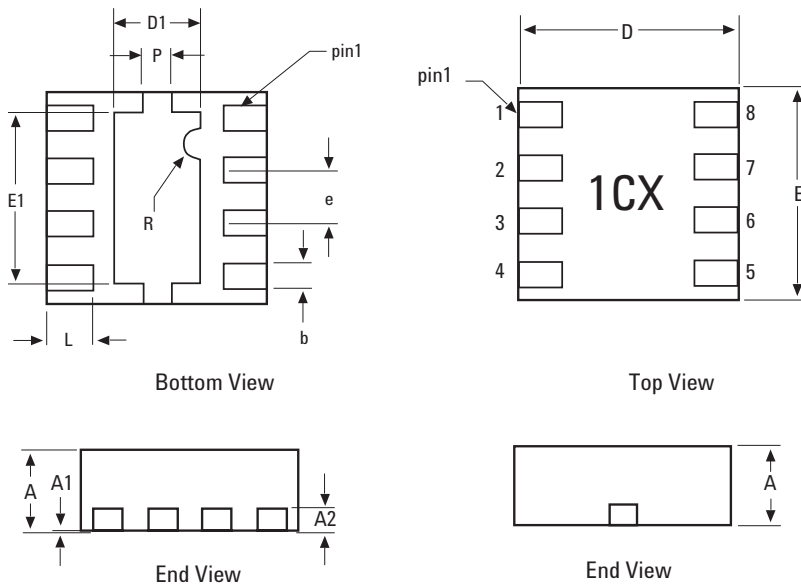

Figure 14. Typical Scattering Parameter Plots

2 x 2LPCC (JEDEC DFP-N) Package Dimensions



SYMBOL	DIMENSIONS		
	MIN.	NOM.	MAX.
A	0.70	0.75	0.80
A1	0	0.02	0.05
A2		0.203 REF	
b	0.225	0.25	0.275
D	1.9	2.0	2.1
D1	0.65	0.80	0.95
E	1.9	2.0	2.1
E1	1.45	1.6	1.75
e		0.50 BSC	
P	0.2	0.25	0.3
L		0.4 REF	

DIMENSIONS ARE IN MILLIMETERS

PCB Land Pattern and Stencil Design

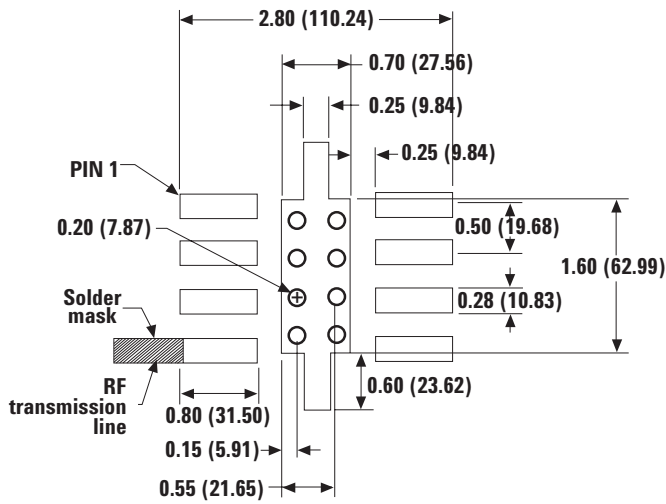

PCB Land Pattern (top view)

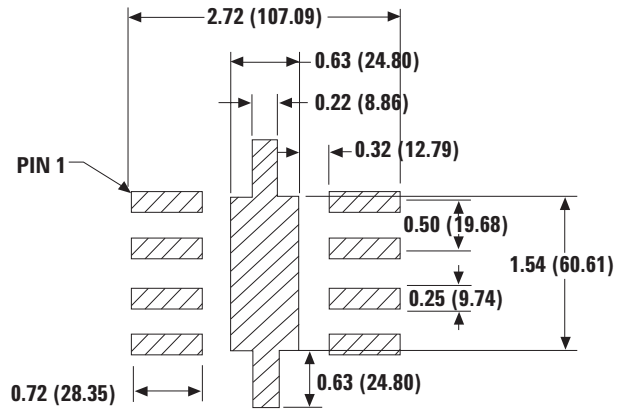

Stencil Layout (top view)

Device Orientation

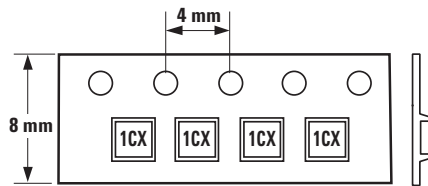
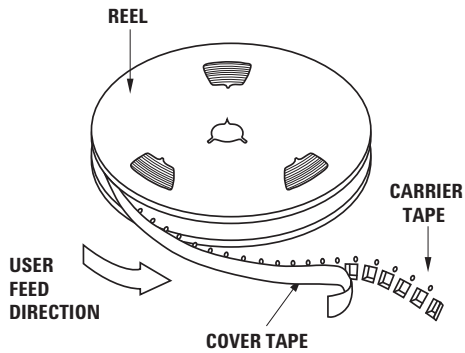

Part Number Ordering Information

Part Number	No. of Devices	Container
MGA-412P8-TR1G	3000	7" Reel
MGA-412P8-TR2G	10000	13" Reel
MGA-412P8-BLKG	100	antistatic bag

For product information and a complete list of distributors, please go to our web site:

www.avagotech.com

Avago, Avago Technologies, and the A logo are trademarks of Avago Technologies in the United States and other countries. Data subject to change. Copyright © 2005-2008 Avago Technologies. All rights reserved. Obsoletes AV01-0236EN AV02-0848EN - August 26, 2008

Avago
TECHNOLOGIES