

SPECIFICATIONS

(RoHS Compliant)



Model Number: MSD48K3E2X-E3

Version: 00

Part Number: 17001161A

Jun 12, 2018

Mechanical Drawing:

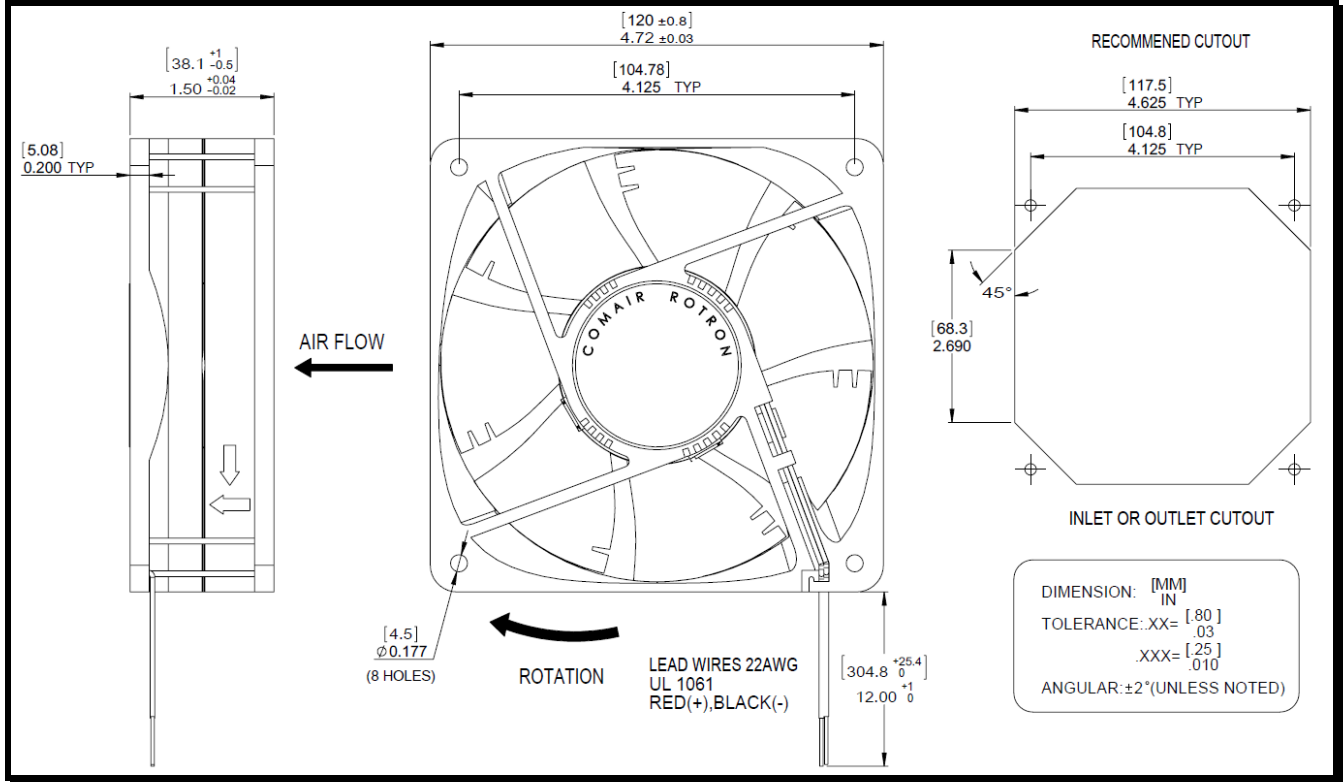

Motor:

Nominal Voltage	= 48 vdc
Operating Voltage Range	= 36 - 60 vdc
Nominal Running Current	= 0.22 amps
Max. Locked Rotor Current	= 1.20 amps
Running Power	= 10.6 watts
Average Speed	= 3400 RPM
Bearings	= Ball
Air Flow	= 120 CFM
Acoustic	= 51.8 dBA

Construction:

Venturi: Plastic, Black, UL 94V-0
Propeller: Plastic, Black, UL 94V-0

Life Expectancy:

This fan is designed for continuous duty life of 45,000 hours at 70°C.

Termination:

12"±1"(304.8±25.4mm) 22AWG UL1061 Leadwires
Red = Power(+)
Black = Return(-)
Blue/White = Tach output
Yellow = PWM control

Additional Features:

Brushless DC Motor
Automatic Restart Capability
Electronic Locked Rotor Protection
Polarity Protected
Operating Temperature: -10°C to 70°C
Storage Temperature: -40°C to 85°C
Environmental Protection: Type 3(IP68)

TACHOMETER:

Output: Open Collector
Ic: 20 mA max.
Vcc: 60 Vdc max.
Pulses per Revolution: 2
Isolated: No

Speed Control:

PWM: 200 ~ 2 KHz, Open Collector
<10% Duty: Off
10%~95% Duty: Linear Ramp
>95% Duty or Open Lead Wire: Full Speed

Agencies:

UL, CUL, CE

PQ Curve:

