

LC05511XA, LC05512XA

Battery Protection IC, OTP Function, 1-Cell Lithium-Ion Battery

Overview

LC05511XA/LC05512XA is a protection IC for 1 cell lithium-ion or lithium-polymer battery with built-in OTP. It provides highly accurate adjustable over-charge, over-discharge, over-current protection with adjustable detection delay by OTP. Current is detected by high precision external chip resistor. Which realizes accurate current detection over temperature.

Function

- Highly Accurate Detection Voltage/Current at $T_A = 25^\circ\text{C}$, $V_{CC} = 3.8\text{ V}$
- Over-charge Detection Voltage: 4.1 V to 4.55 V (5 mV steps)
- Over-charge Release Hysteresis: 0 V, 0.1 V, 0.15 V, 0.2 V
- Over-discharge Detection Voltage: 2.0 V to 3.3 V (50 mV step)
- Over-discharge Release Hysteresis: 0 V to 0.075 V (25 mV step)
- Over-discharge Release Hysteresis2: 0 V, 0.2 V, 0.3 V, 0.4 V
- Discharge Over-current Detection Voltage1: 3 mV to 30 mV (0.3 mV step)
- Discharge Over-current Detection Voltage2: 3 mV to 30 mV (0.6 mV step)
- Short Current Detection Voltage: 20 mV to 70 mV (5 mV step)
- Charge Over-current Detection Voltage: -30 mV to -3 mV (-0.6 mV step)
- Over-charge Detection Delay Time: 512 ms, 1024 ms, 2048 ms, 4096 ms
- Over-discharge Detection Delay Time: 32 ms, 64 ms, 128 ms, 256 ms
- Discharge Over-current Detection Delay Time1: 32 ms, 64 ms, 128 ms, 256 ms, 512 ms, 1024 ms, 2048 ms, 3482 ms
- Discharge Over-current Detection Delay Time2: 4 ms, 8 ms, 16 ms, 32 ms
- Short-current Detection Delay Time: 250 μs , 450 μs
- Charge Over-current Detection Delay Time: 4 ms, 8 ms, 16 ms, 128 ms
- 0 V Battery Charging: "Permission (LC05511XA)", "Inhibit (LC05512XA)"
- Auto Wake-up Function: "Permission (LC05511XA)", "Inhibit (LC05512XA)"

Typical Applications

- Smart Phone
- Tablet
- Wearable Device



ON Semiconductor®

www.onsemi.com



WLCSP6
0.85 x 1.17 x 0.40
CASE 567TL

PART MARKING

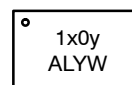

1x0y = Specific Device Code
x = 1 or 2
y = 1, 2, 3 or 4
A = Assembly Location
L = Wafer Lot
Y = Year
W = Work Week

ORDERING INFORMATION

Device	Package	Shipping†
LC05511Z01XA	WLCSP6 (Pb-Free)	5000 / Tape & Reel
LC05511Z02XA	WLCSP6 (Pb-Free)	5000 / Tape & Reel
LC05511Z03XA	WLCSP6 (Pb-Free)	5000 / Tape & Reel
LC05511Z04XA	WLCSP6 (Pb-Free)	5000 / Tape & Reel
LC05512Z01XA	WLCSP6 (Pb-Free)	5000 / Tape & Reel

†For information on tape and reel specifications, including part orientation and tape sizes, please refer to our Tape and Reel Packaging Specification Brochure, BRD8011/D.

LC05511XA, LC05512XA

SPECIFICATIONS

ABSOLUTE MAXIMUM RATINGS

Parameter	Symbol	Conditions	Ratings	Unit
Supply Voltage	VCC		-0.3 to 12.0	V
CS Terminal Input Voltage	VCS		-0.3 to 7	V
VM Terminal Input Voltage	VVM		VCC - 24.0 to VCC + 0.3	V
CO Terminal Voltage	VCO		VCC - 24.0 to VCC + 0.3	V
DO Terminal Voltage	VDO		-0.3 to 7	V
Storage Temperature	T _{stg}		-55 to +125	°C
Operating Ambient Temperature	T _{opr}		-40 to +85	°C
Allowable Power Dissipation	P _d	Glass epoxy two-layer board. Board size 42 mm × 30 mm × 1.6 mm	0.55	W
Junction Temperature	T _j		125	°C

Stresses exceeding those listed in the Maximum Ratings table may damage the device. If any of these limits are exceeded, device functionality should not be assumed, damage may occur and reliability may be affected.

EXAMPLE OF APPLICATION CIRCUIT

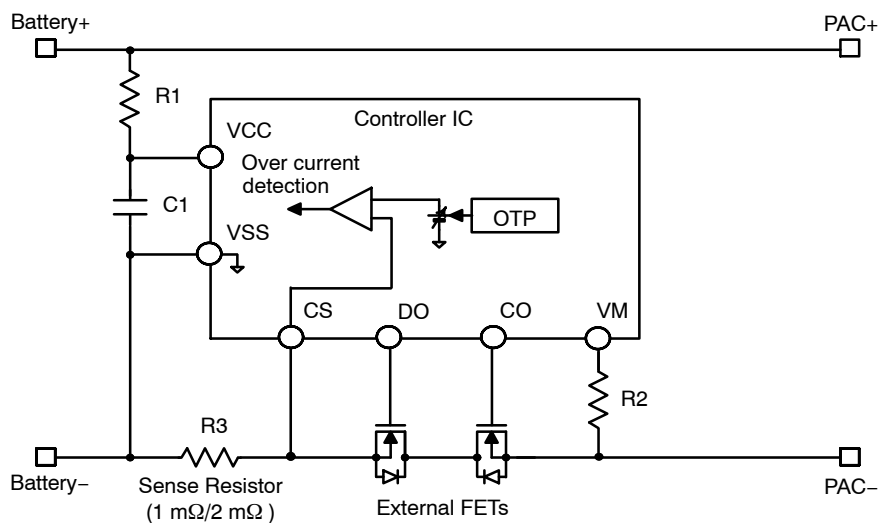

Figure 1. Example of Application Circuit

Components	Min	Recommended Value	Max	unit	Description
R1	0.68	1	1.2	kΩ	Battery+ is filtered to VCC by R1 and C1
R2	0.1	1	2	kΩ	Protection from reverse connection of charger
C1	0.01	0.1	1.0	μF	Battery+ is filtered to VCC by R1 and C1
R3	1		20	mΩ	Sense resistor for over-current detection

LC05511XA, LC05512XA

ELECTRICAL CHARACTERISTICS (R1 = 1 kΩ, R2 = 1 kΩ, VCC = 3.8 V (Note 1))

Parameter	Symbol	Conditions	Min	Typ	Max	Unit	TEST Circuit	
DETECTION VOLTAGE								
Over-charge Detection Voltage	Vov	R1 = 1 kΩ	T _A = 25°C	Vov_set - 15	Vov_set	Vov_set + 15	mV	B
			T _A = -20 to 60°C	Vov_set - 20	Vov_set	Vov_set + 20		
Over-charge Release Voltage	Vovr1	R1 = 1 kΩ VM < Vccocr & CS = 0	T _A = 25°C	Vovr_set - 30	Vovr_set	Vovr_set + 30	mV	B
			T _A = -20 to 60°C	Vovr_set - 55	Vovr_set	Vovr_set + 40		
	Vovr2	R1 = 1 kΩ VM > Vccocr & CS = 0	T _A = 25°C	Vov_set - 20	Vov_set	Vov_set + 15	mV	I
			T _A = -20 to 60°C	Vov_set - 25	Vov_set	Vov_set + 20		
Over-discharge Detection Voltage	Vuv	R1 = 1 kΩ	T _A = 25°C	Vuv_set - 35	Vuv_set	Vuv_set + 35	mV	B
			T _A = -20 to 60°C	Vuv_set - 55	Vuv_set	Vuv_set + 55		
Over-discharge Release Voltage1	Vuvr1	R1 = 1 kΩ VM = 0 V	T _A = 25°C	Vuvr1_set - 50	Vuvr1_set	Vuvr1_set + 50	mV	B
			T _A = -20 to 60°C	Vuvr1_set - 80	Vuvr1_set	Vuvr1_set + 80		
Over-discharge Release Voltage2	Vuvr2	R1 = 1 kΩ VM = Open	T _A = 25°C	Vuvr2_set - 100	Vuvr2_set	Vuvr2_set + 100	mV	D
			T _A = -20 to 60°C	Vuvr2_set - 110	Vuvr2_set	Vuvr2_set + 110		
Discharge Over-current Detection Voltage (Primary Protection)	Vdoc1	R2 = 1 kΩ	T _A = 25°C	Vdoc1 - 0.9	Vdoc1_set	Vdoc1 + 0.9	mV	F
			T _A = -20 to 60°C	Vdoc1 - 1.0	Vdoc1_set	Vdoc1 + 1.0		
Discharge Over-current Detection Voltage2 (Secondary Protection)	Vdoc2	R2 = 1 kΩ	T _A = 25°C	Vdoc1 - 1.8	Vdoc2_set	Vdoc1 + 1.8	mV	F
			T _A = -20 to 60°C	Vdoc1 - 2.0	Vdoc2_set	Vdoc1 + 2.0		
Discharge Over-current Detection Voltage (Short circuit)	Vshrt	R2 = 1 kΩ	T _A = 25°C	Vshrt_set - 5	Vshrt_set	Vshrt_set + 5	mV	F
			T _A = -20 to 60°C	Vshrt_set - 6	Vshrt_set	Vshrt_set + 6		
Discharge Over-current (Short) Release Voltage	Vdocr	R2 = 1 kΩ CS = 0 V	T _A = 25°C	VCC - 1.1	VCC - 0.65	VCC - 0.2	V	A
			T _A = -20 to 60°C	VCC - 1.2	VCC - 0.65	VCC - 0.1		
Charge Over-current Detection Voltage	Vcoc	R2 = 1 kΩ	T _A = 25°C	Vcoc_set - 1.8	Vcoc_set	Vcoc_set + 1.8	mV	F
			T _A = -20 to 60°C	Vcoc_set - 2.0	Vcoc_set	Vcoc_set + 2.0		
Charge Over-current Release Voltage	Vccocr	R2 = 1 kΩ CS = 0 V	T _A = 25°C	0.08	0.2	0.32	V	A
			T _A = -20 to 60°C	0.05	0.2	0.35		

INPUT VOLTAGE

0 V Battery Charge Permission Charger Voltage (LC05511XA)	Vchg	VCC - VM VCC = VSS = 0 V	25°C			1.4	V	A
0 V Battery Charging Inhibition Battery Voltage (LC05512XA)	Vinh	VM = -2 V		0.85	1.0	1.15		

CURRENT CONSUMPTION

Operating Current	Icc	At normal state	25°C VCC = 3.8 V		3	6	μA	J
Stand-by Current (LC05511XA)	Istb	At Stand-by state Auto wake-up = enable	25°C VCC = 2.0 V			0.95	μA	J
Shutdown Current (LC05512XA)	Ishut	At Shutdown state				0.1		

RESISTANCE

Internal Resistance (VCC-VM)	Rvmu	VCC = 2.0 V VM = 0 V	25°C	150	300	600	kΩ	E
Internal Resistance (VSS-VM)	Rvmd	VCC = 3.8 V VM = 0.1 V	25°C	5	10	20	kΩ	E
CO Output Resistance (High)	Rcoh	VCC = 3.8 V CO = 3.3 V CS = 0 V	25°C	6	12	24	kΩ	H
CO Output Resistance (Low)	Rcol	VCC = 4.5 V CO = 0.5 V CS = 0 V	25°C	0.35	0.7	1.4	kΩ	H
DO Output Resistance (High)	Rdoh	VCC = 3.8 V DO = 3.3 V CS = 0 V	25°C	0.8	1.6	3.2	kΩ	G

LC05511XA, LC05512XA

ELECTRICAL CHARACTERISTICS (R1 = 1 kΩ, R2 = 1 kΩ, VCC = 3.8 V (Note 1))

Parameter	Symbol	Conditions	Min	Typ	Max	Unit	TEST Circuit
-----------	--------	------------	-----	-----	-----	------	--------------

RESISTANCE

DO Output Resistance (Low)	Rdol	VCC = 2.0 V CS = 0 V DO = 0.5 V	25°C	0.1	0.3	0.6	kΩ	G
----------------------------	------	---------------------------------------	------	-----	-----	-----	----	---

DETECTION AND RELEASE DELAY TIME

Over-charge Detection Delay Time	Tov	VCC = Vovr1_min to Vovr1_max VM = CS = 0 V	25°C	Tov_set × 0.8	Tov_set	Tov_set × 1.2	ms	B
			T _A = -20 to 60°C	Tov_set × 0.7	Tov_set	Tov_set × 1.3		
Over-charge Release Delay Time	Tovr	VCC = Vovr1_max to Vovr1_min VM = CS = 0 V	25°C	12.8	16	19.2	ms	B
			T _A = -20 to 60°C	11.2	16	20.8		
Over-discharge Detection Delay Time	Tuv	VCC = Vuvr1_max to Vuvr1_min VM = CS = 0 V	25°C	Tuv_set × 0.8	Tuv_set	Tuv_set × 1.2	ms	B
			T _A = -20 to 60°C	Tuv_set × 0.65	Tuv_set	Tuv_set × 1.35		
Over-discharge Release Delay Time	Tuvr	VCC = Vuvr1_min to Vuvr1_max VM = CS = 0 V	25°C	0.84	1.05	1.26	ms	B
			T _A = -20 to 60°C	0.68	1.05	1.42		
Discharge Over-current Detection Delay Time 1	Tdoc1	CS = 0 V to Vdoc1_max VM = 0 V	25°C	Tdoc1_set × 0.8	Tdoc1_set	Tdoc1_set × 1.2	ms	F
			T _A = -20 to 60°C	Tdoc1_set × 0.7	Tdoc1_set	Tdoc1_set × 1.3		
Discharge Over-current Detection Delay Time 2	Tdoc2	VM = 0 V to Vdoc2_max VM = 0 V	25°C	Tdoc2_set × 0.8	Tdoc2_set	Tdoc2_set × 1.2	ms	F
			T _A = -20 to 60°C	Tdoc2_set × 0.7	Tdoc2_set	Tdoc2_set × 1.3		
Discharge Over-current Release Delay Time	Tdocr	VM = 3.8 V to 2.7 V CS = 0 V	25°C	3.2	4	4.8	ms	A
			T _A = -20 to 60°C	2.8	4	5.2		
Short-current Detection Delay Time	Tshrt	CS = 0 V to Vshrt_max VM = 0 V	25°C	Tshrt_set × 0.7	Tshrt_set	Tshrt_set × 1.3	μs	F
			T _A = -20 to 60°C	Tshrt_set × 0.6	Tshrt_set	Tshrt_set × 1.4		
Charge Over-current Detection Delay Time	Tcoc	CS = 0 V to Vcoc_min VM = 0 V	25°C	Tcoc_set × 0.8	Tcoc_set	Tcoc_set × 1.2	ms	F
			T _A = -20 to 60°C	Tcoc_set × 0.7	Tcoc_set	Tcoc_set × 1.3		
Charge Over-current Release Delay Time	Tcocr	VM = 0 V to Vcocr_max CS = 0 V	25°C	3.2	4	4.8	ms	F
			T _A = -20 to 60°C	2.8	4	5.2		

Product parametric performance is indicated in the Electrical Characteristics for the listed test conditions, unless otherwise noted. Product performance may not be indicated by the Electrical Characteristics if operated under different conditions.

1. The specification in high temperature and low temperature are guaranteed by design.

LC05511XA, LC05512XA

TEST CIRCUITS

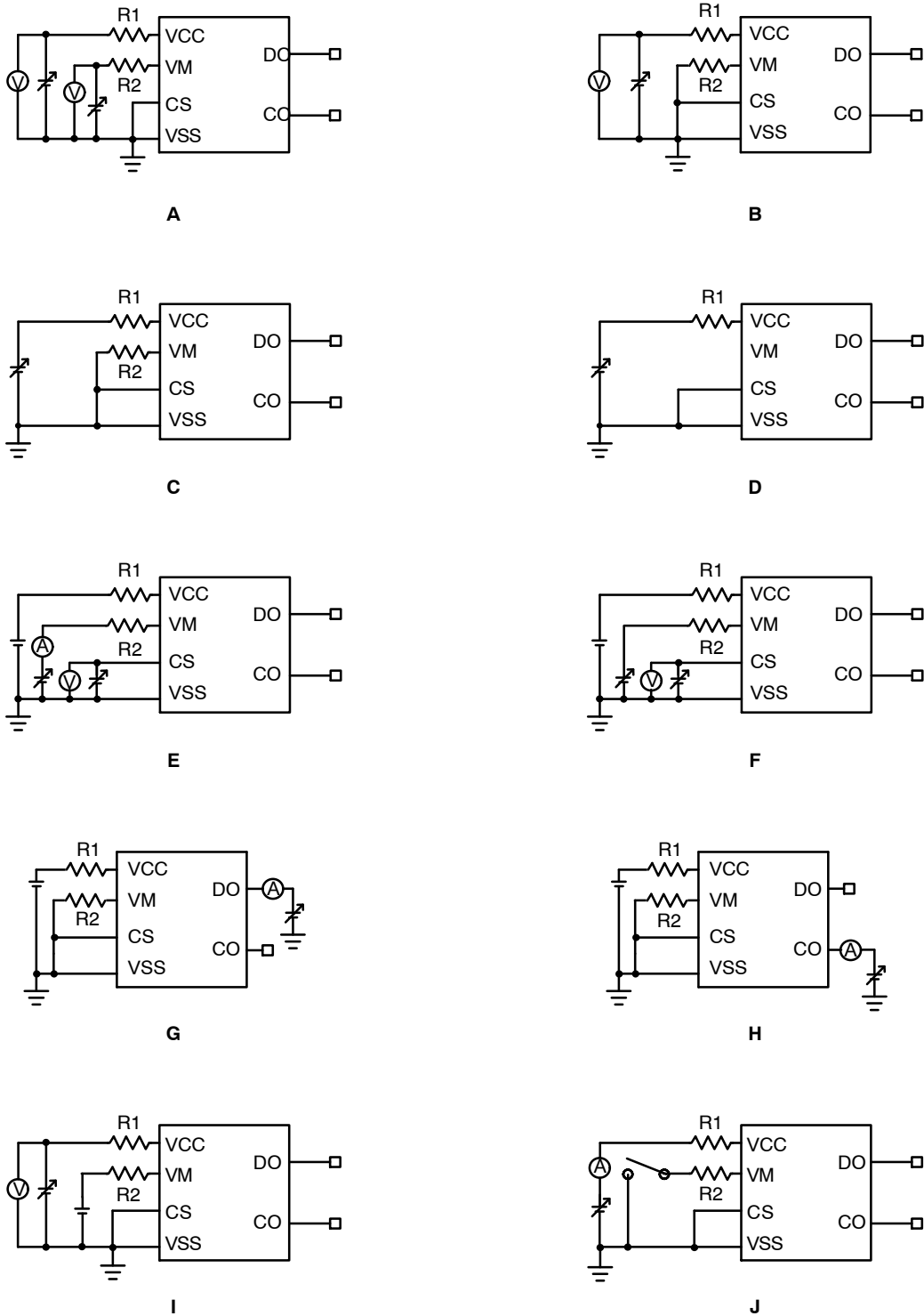

Figure 2. Test Circuits

LC05511XA, LC05512XA

Table 1. ADJUSTABLE PARAMETERS

Parameter	Unit	Range	Typical Value Setting Guide
Vov	mV	4100~4550	5 mV step
Vovr	mV	Vov – Vovr_Hy	Vovr_Hy: 0, 100, 150, 200 (4 steps)
Vuv	mV	2000~3300	50 mV step
Vuvr1	mV	Vuv + Vuvr1_Hy	Vuvr1_Hy: 0, 25, 50, 75 (4 steps)
Vuvr2	mV	Vuv + Vuvr2_Hy	Vuvr2_Hy: 0, 200, 300, 400 (4 steps)
Vdoc1	mV	3 to 30	0.3 mV step
Vdoc2	mV	3 to 30	0.6 mV step
Vshrt	mV	20 to 70	5 mV step
Vcoc	mV	-30 to -3	0.6 mV step

Parameter	Unit	Typical Value Setting Guide
Tov	ms	512, 1024, 2048, 4096
Tuv	ms	32, 64, 128, 256
Tdoc1	ms	32, 64, 128, 256, 512, 1024, 2048, 3482
Tdoc2	ms	4, 8, 16, 32
Tshrt	μs	250, 450
Tcoc	ms	4, 8, 16, 128

Table 2. SELECTION GUIDE

Device	Vov (mV)	Vovr1 (mV)	Vovr2 (mV)	Vuv (mV)	Vuvr1 (mV)	Vuvr2 (mV)	Vdoc1 (mV)	Vdoc2 (mV)	Vshrt (mV)	Vcoc (mV)	Tov (ms)	Tuv (ms)	Tdoc1 (ms)	Tdoc2 (ms)	Tshrt (μs)	Tcoc (ms)
LC05511Z01XA	4475	4325	4475	2500	2500	2900	14.0	20.0	50.0	-14.0	1024	64	3482	16	250	16
LC05511Z02XA	4530	4380	4530	2350	2350	2550	14.0	20.0	50.0	-20.0	1024	64	3482	16	250	16
LC05511Z03XA	4475	4325	4475	2500	2500	2900	7.5	10.0	25.0	-10.0	1024	64	3482	16	250	16
LC05511Z04XA	4530	4380	4530	2350	2350	2550	7.5	10.0	25.0	-12.5	1024	64	3482	16	250	16
LC05512Z01XA	4475	4325	4475	2300	2300	-	15	20.0	30	-10.2	1024	64	32	8	250	16

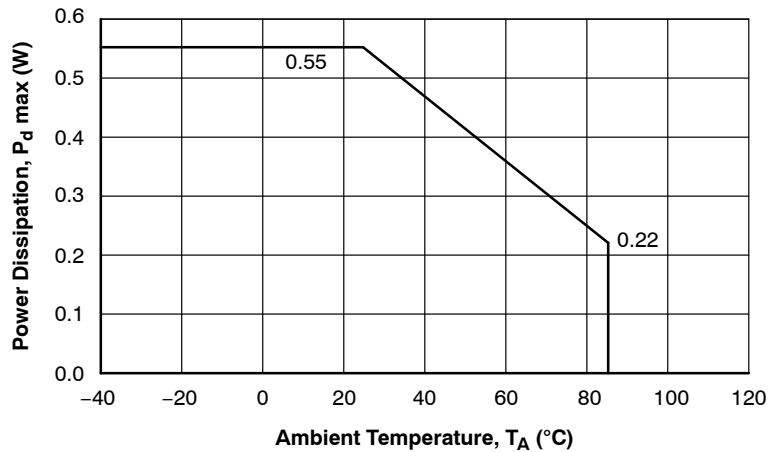

Figure 3. P_d max- T_A Graph

LC05511XA, LC05512XA

Table 3. PIN FUNCTION

Pin No.	Symbol	Pin Function
A1	VSS	VSS terminal
A2	VCC	VCC terminal
A3	CS	Over-current detection input terminal
B1	DO	Discharge FET control terminal
B2	CO	Charge FET control terminal
B3	VM	Charger negative voltage input terminal

BLOCK DIAGRAM

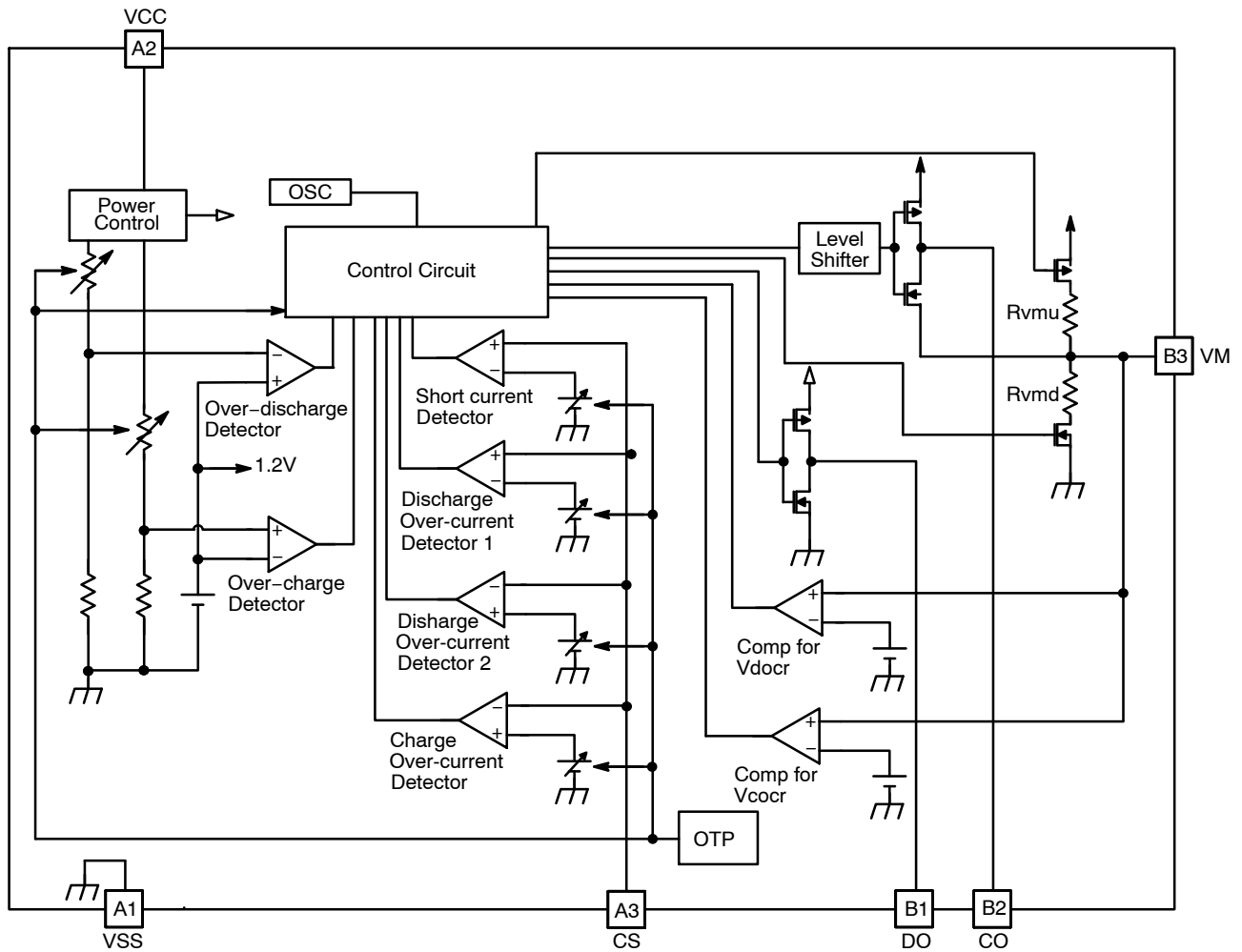

Figure 4. Block Diagram

DESCRIPTION OF OPERATION

The battery voltage is detected between VCC pin and VSS pin and the battery current is detected between VSS pin and CS pin.

(1) Normal State

- “VCC voltage” is between “over-discharge detection voltage (Vuv)”, “over-charge detection voltage (Vov)”, and “CS voltage” is between “charge over-current detection voltage (Vcoc)”, “discharge over-current detection voltage (Vdoc)”, and “VM voltage” is lower than “dicharge over-current (short) release voltage (Vdocr)”.

This is the normal state. Both CO and DO are high level output. Charge and discharge is allowed.

(2) Over-charging State

- “VCC voltage” is higher than or equal to “over-charge detection voltage (Vov)” for longer than “over-charge detection delay time (Tov)”.

This is the over-charging state, CO is low level output. Charge is prohibited.

- Release from Over-charging State 1

“VM voltage” is lower than “charge over-current (short) release voltage (Vcocr)”. Then “VCC voltage” is lower than “over-charge release voltage1 (Vovr1)” for longer than “over-charging release delay time (Tovr)”.

- Release from Over-charging State 2

“VM voltage” is higher than “charge over-current (short) release voltage (Vcocr)”. Then “VCC voltage” is lower than “over-charge release voltage2 (Vovr2)” for longer than “over-charge release delay time (Tovr)”.

(3) Over-discharging State

- “VCC voltage” is lower than “over-discharge detection voltage (Vuv)” for longer than “over-discharge delay time (Tuv)”.

This is the over-discharging state, DO is low level output. Discharge is prohibited.

During over-discharging state, VM pin is pulled up to Vcc by internal resistor (Rvmu) and circuits are shut down. The low power consumption is kept.

- Release from Over-discharging State 1

Charger is connected, then “VCC voltage” goes higher than “over-discharge release voltage1 (Vuvr1)” for longer than “over-discharge release delay time (Tuvr)”.

- Release from Over-discharging State

(with Auto Wake-up Feature) 2 (LC05511XA)
 “VCC voltage” is higher than “over-discharge release voltage2 (Vuvr1)” without charger for longer than “over-discharge release delay time (Tuvr)”.

(4) Discharging Over-current State

- Discharge Over-current Detection 1

CS terminal is higher than or equal to “discharge over-current detection voltage (Vdoc1)” for longer than “discharge over-current detection delay time (Tdoc1)”. DO is low level output. Discharge is prohibited.

- Discharge Over-current Detection 2

CS terminal is higher than or equal to “discharge over-current detection voltage2 (Vdoc2)” for longer than “discharge over-current detection delay time 2 (Tdoc2)”.

DO is low level output. Discharge is prohibited.

- Discharge Over-current Detection (Short Circuit)

CS terminal is higher than or equal to “discharge over-current detection voltage (Short circuit) (Vshrt)” for longer than “short-current detection delay time (Tshrt)”.

DO is low level output. Discharge is prohibited.

During discharging over-current state, VM pin is pulled down to Vss by internal resistor (Rvmd).

- Release from Discharging Over-current State

“CS voltage” goes lower than “discharge over-current detection voltage (Vdoc1)” and VM voltage goes lower than “discharge over-current (short) release voltage (Vdocr)” for longer than “discharge over-current release delay time (Tdocr)”.

(5) Charging Over-current State

- “CS voltage” goes lower than or equal to “charge over-current detection voltage (Vcoc) for longer than “charge over-current detection delay time (Tcoc)”.

This is the charging over-current state, CO is low level output. Charge is prohibited.

- Release from charging over-current state

“CS voltage” goes lower than “charge over-current detection voltage (Vcoc)” and “VM voltage” goes lower than “charge over-current release voltage (Vcocr)” for longer than “charge over-current release delay time (Tcocr)”.

(6) 0 V Battery Charging (LC05511XA)

- When the Battery voltage is lower than or equal to “0 V battery charge permission voltage (Vchg)”, charge is allowed if charger voltage is higher than or equal “0 V battery charge permission voltage (Vchg)”. CO is fixed by the “VCC voltage”.

(7) 0 V Battery Protection Function (LC05512XA)

- This function protects the battery when a short circuit in the battery (0 V battery) is detected, at which point charging will be prohibited.

When the voltage of a battery is below “0 V battery charging inhibition battery voltage (Vinh)”, CO is low level output. Charge is prohibited.

TIMING CHARTS

Over Charge Voltage and Charge Over Current

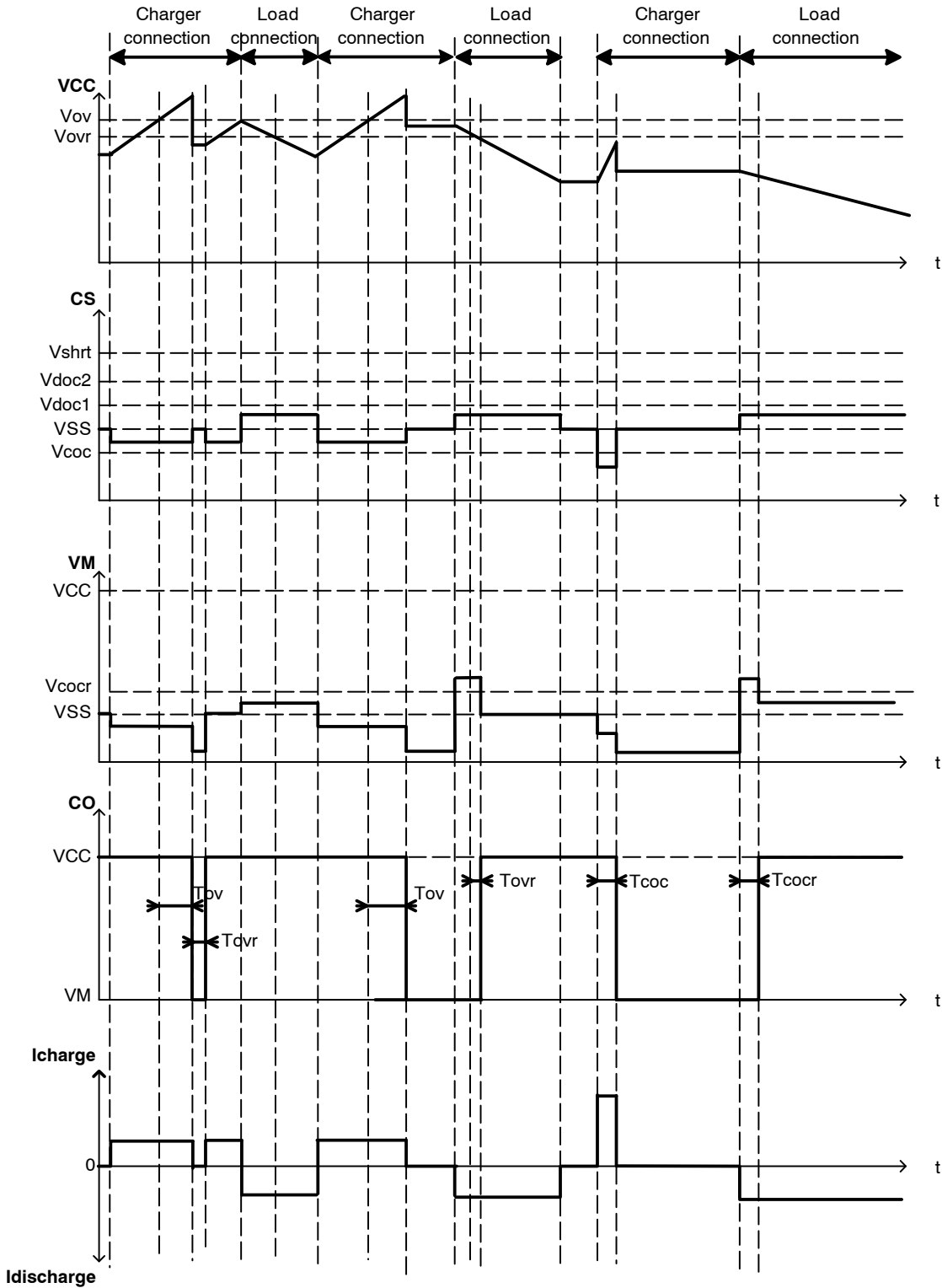

Figure 5. Over Charge Voltage and Charge Over Current

LC05511XA, LC05512XA

Over Discharge Detection and Release (with/without Charger)

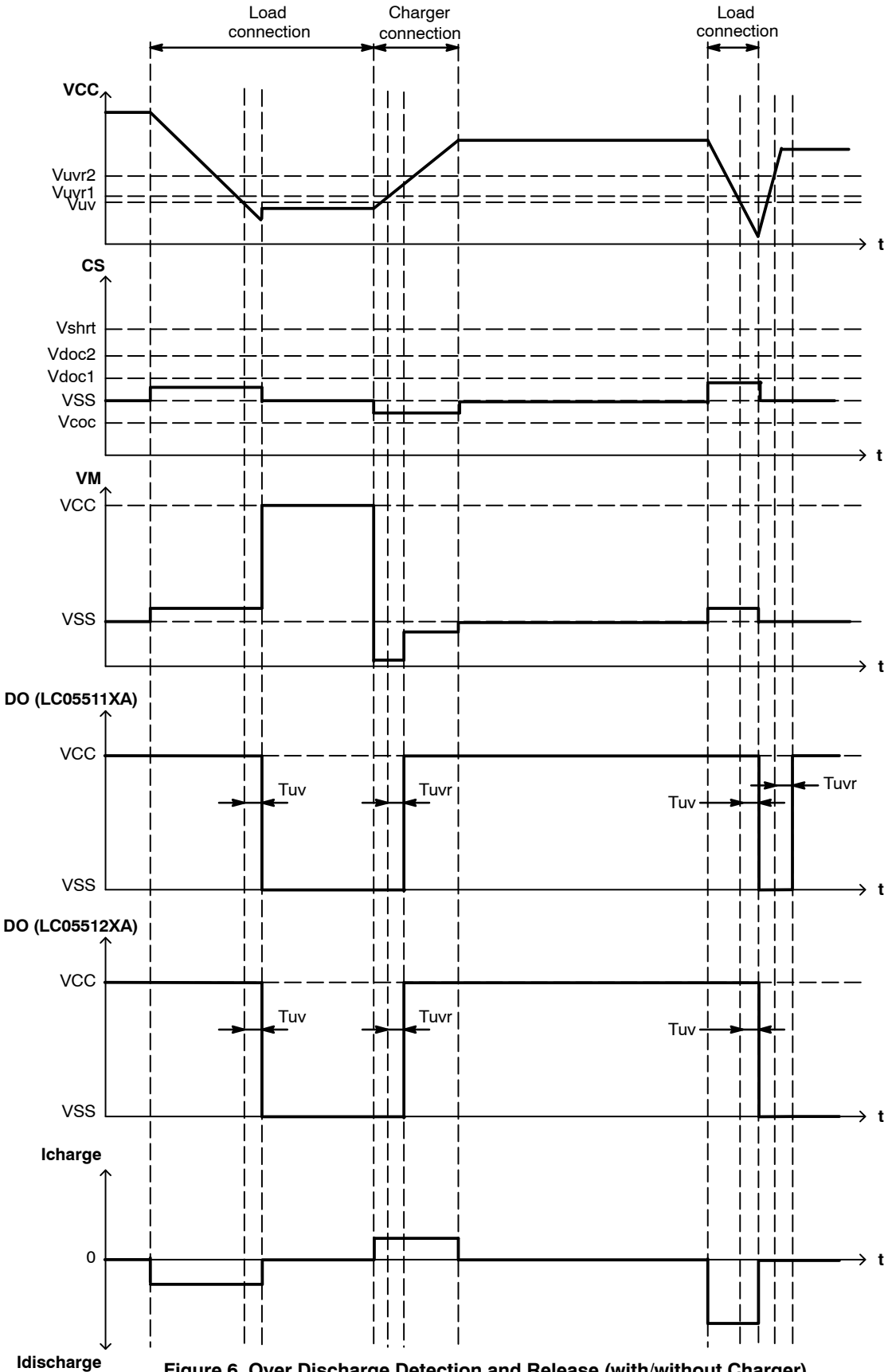

Figure 6. Over Discharge Detection and Release (with/without Charger)

LC05511XA, LC05512XA

Discharge Over Current and Short Current Detection and Release

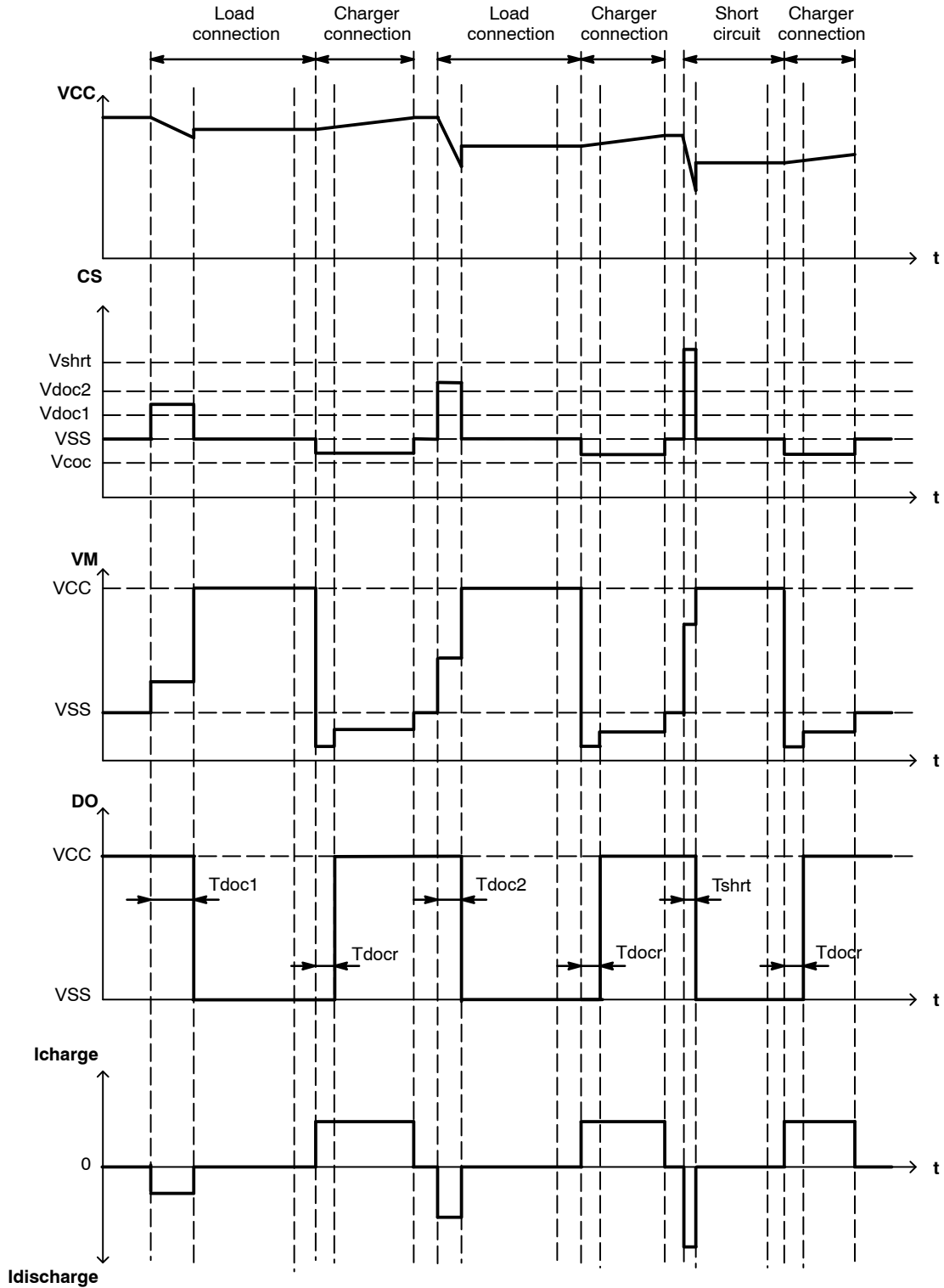

Figure 7. Discharge Over Current and Short Current Detection and Release

LC05511XA, LC05512XA

CHARACTERISTICS OF LC05511Z04XA (TYPICAL DATA)

(1) Current Consumption and Protection Detection Voltage

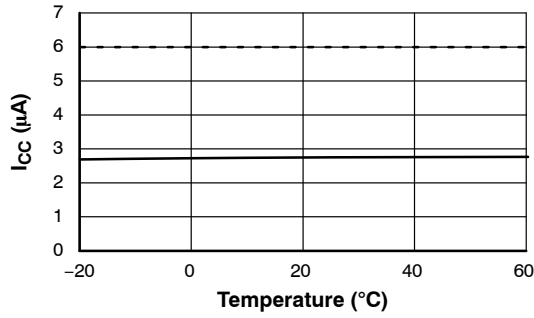

Figure 8. I_{CC} vs. Temperature

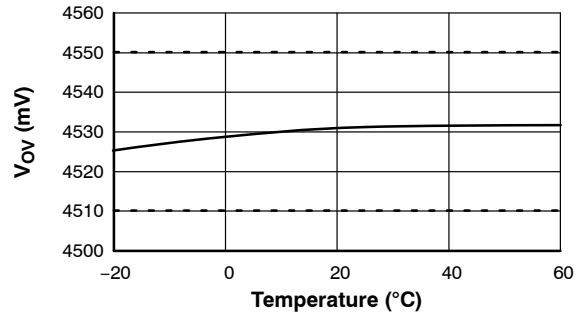

Figure 9. V_{OV} vs. Temperature

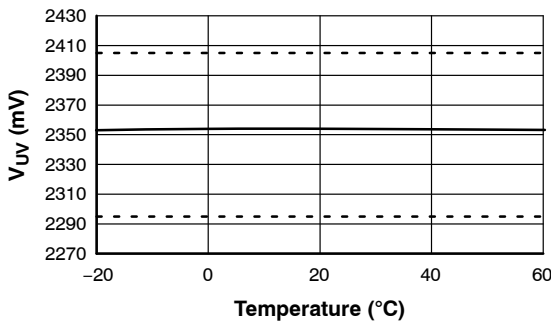

Figure 10. V_{UV} vs. Temperature

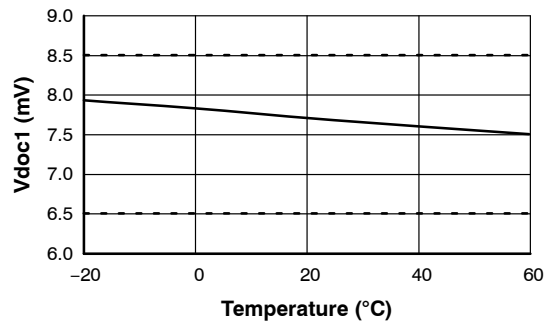

Figure 11. V_{doc1} vs. Temperature

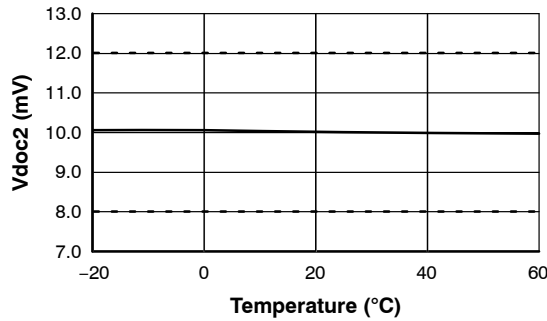

Figure 12. V_{doc2} vs. Temperature

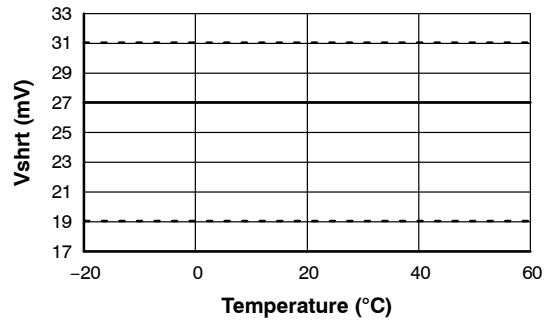

Figure 13. V_{shrt} vs. Temperature

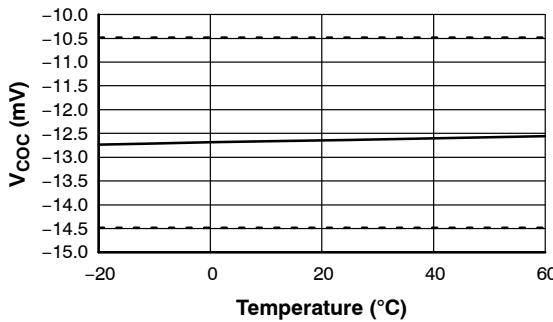

Figure 14. V_{COC} vs. Temperature

CHARACTERISTICS OF LC05511Z04XA (TYPICAL DATA)

(2) Protection Detection Delay Time

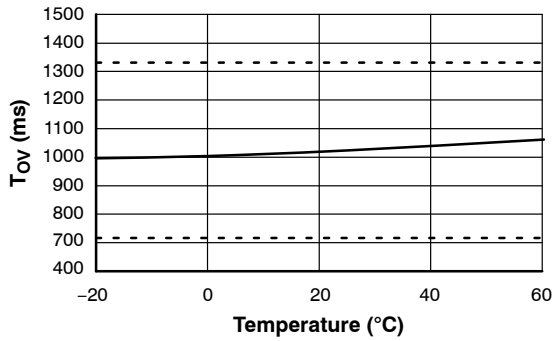

Figure 15. T_{OV} vs. Temperature

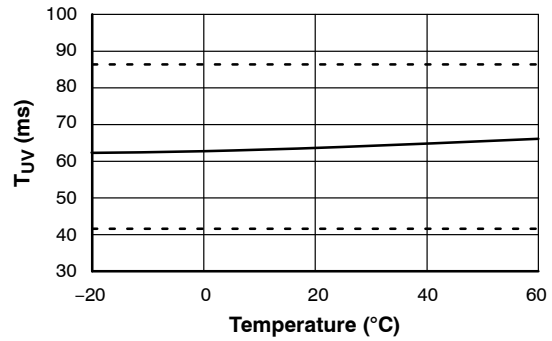

Figure 16. T_{UV} vs. Temperature

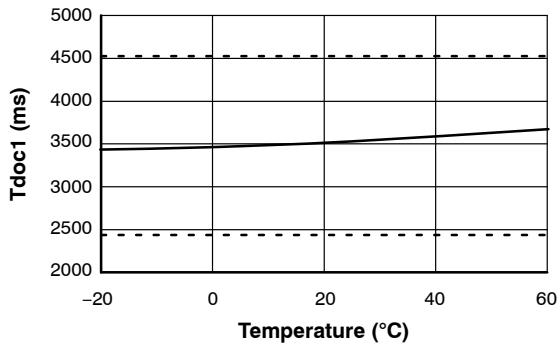

Figure 17. T_{doc1} vs. Temperature

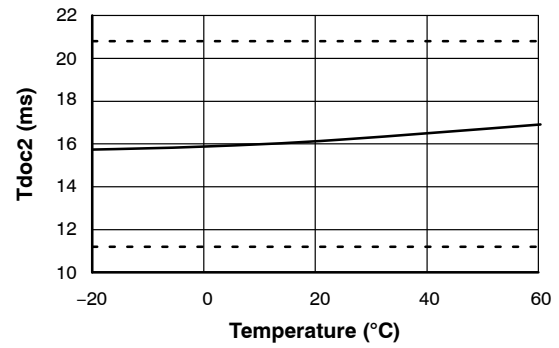

Figure 18. T_{doc2} vs. Temperature

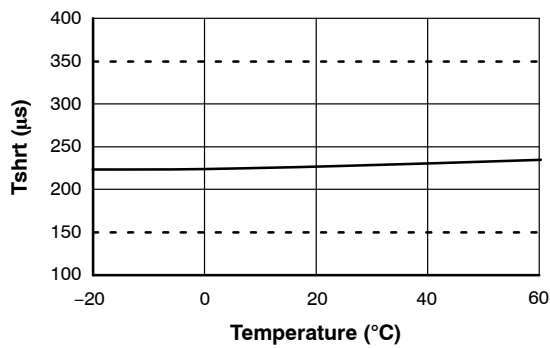

Figure 19. T_{shrt} vs. Temperature

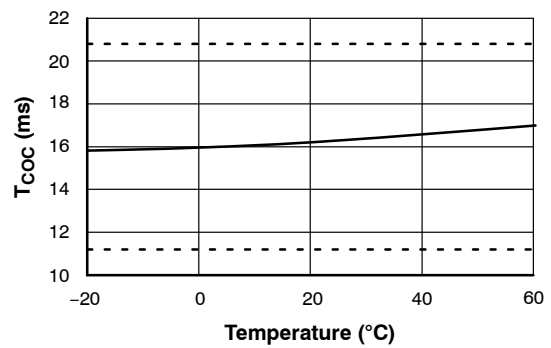

Figure 20. T_{COV} vs. Temperature

MECHANICAL CASE OUTLINE

PACKAGE DIMENSIONS

ON Semiconductor®



SCALE 4:1

WLCSP6 0.85x1.17x0.40
CASE 567TL
ISSUE O

DATE 14 MAR 2017

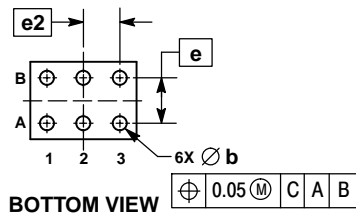
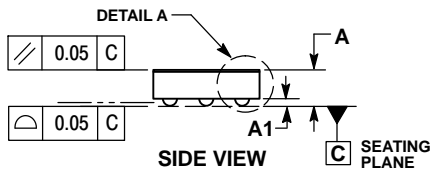
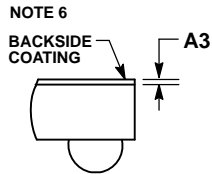
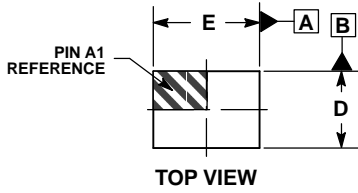

NOTES:

1. DIMENSIONING AND TOLERANCING PER ASME Y14.5M, 1994.
2. CONTROLLING DIMENSION: MILLIMETERS.
3. DATUM C, THE SEATING PLANE, IS DEFINED BY THE SPHERICAL CROWNS OF THE CONTACT BALLS.
4. COPLANARITY APPLIES TO THE SPHERICAL CROWNS OF THE SOLDER BALLS.
5. DIMENSION b IS MEASURED AT THE MAXIMUM CONTACT BALL DIAMETER PARALLEL TO DATUM C.
6. BACKSIDE COATING IS OPTIONAL.

DIM	MILLIMETERS		
	MIN	NOM	MAX
A	---	---	0.40
A1	0.05	0.08	0.11
A3	0.025 REF		
b	0.11	0.16	0.21
D	0.80	0.85	0.90
E	1.12	1.17	1.22
e	0.50 BSC		
e2	0.40 BSC		

RECOMMENDED SOLDERING FOOTPRINT*

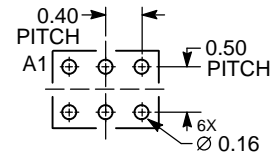

DIMENSIONS: MILLIMETERS

*For additional information on our Pb-Free strategy and soldering details, please download the ON Semiconductor Soldering and Mounting Techniques Reference Manual, SOLDERRM/D.

DOCUMENT NUMBER:	98AON29812G	Electronic versions are uncontrolled except when accessed directly from the Document Repository. Printed versions are uncontrolled except when stamped "CONTROLLED COPY" in red.
STATUS:	ON SEMICONDUCTOR STANDARD	
NEW STANDARD:		
DESCRIPTION:	WLCSP6 0.85X1.17X0.40	PAGE 1 OF 2



ISSUE	REVISION	DATE
O	RELEASED FOR PRODUCTION. REQ. BY M. MACARAIG.	14 MAR 2017

ON Semiconductor and are registered trademarks of Semiconductor Components Industries, LLC (SCILLC). SCILLC reserves the right to make changes without further notice to any products herein. SCILLC makes no warranty, representation or guarantee regarding the suitability of its products for any particular purpose, nor does SCILLC assume any liability arising out of the application or use of any product or circuit, and specifically disclaims any and all liability, including without limitation special, consequential or incidental damages. "Typical" parameters which may be provided in SCILLC data sheets and/or specifications can and do vary in different applications and actual performance may vary over time. All operating parameters, including "Typicals" must be validated for each customer application by customer's technical experts. SCILLC does not convey any license under its patent rights nor the rights of others. SCILLC products are not designed, intended, or authorized for use as components in systems intended for surgical implant into the body, or other applications intended to support or sustain life, or for any other application in which the failure of the SCILLC product could create a situation where personal injury or death may occur. Should Buyer purchase or use SCILLC products for any such unintended or unauthorized application, Buyer shall indemnify and hold SCILLC and its officers, employees, subsidiaries, affiliates, and distributors harmless against all claims, costs, damages, and expenses, and reasonable attorney fees arising out of, directly or indirectly, any claim of personal injury or death associated with such unintended or unauthorized use, even if such claim alleges that SCILLC was negligent regarding the design or manufacture of the part. SCILLC is an Equal Opportunity/Affirmative Action Employer. This literature is subject to all applicable copyright laws and is not for resale in any manner.

ON Semiconductor and  are trademarks of Semiconductor Components Industries, LLC dba ON Semiconductor or its subsidiaries in the United States and/or other countries. ON Semiconductor owns the rights to a number of patents, trademarks, copyrights, trade secrets, and other intellectual property. A listing of ON Semiconductor's product/patent coverage may be accessed at www.onsemi.com/site/pdf/Patent-Marking.pdf. ON Semiconductor reserves the right to make changes without further notice to any products herein. ON Semiconductor makes no warranty, representation or guarantee regarding the suitability of its products for any particular purpose, nor does ON Semiconductor assume any liability arising out of the application or use of any product or circuit, and specifically disclaims any and all liability, including without limitation special, consequential or incidental damages. Buyer is responsible for its products and applications using ON Semiconductor products, including compliance with all laws, regulations and safety requirements or standards, regardless of any support or applications information provided by ON Semiconductor. "Typical" parameters which may be provided in ON Semiconductor data sheets and/or specifications can and do vary in different applications and actual performance may vary over time. All operating parameters, including "Typicals" must be validated for each customer application by customer's technical experts. ON Semiconductor does not convey any license under its patent rights nor the rights of others. ON Semiconductor products are not designed, intended, or authorized for use as a critical component in life support systems or any FDA Class 3 medical devices or medical devices with a same or similar classification in a foreign jurisdiction or any devices intended for implantation in the human body. Should Buyer purchase or use ON Semiconductor products for any such unintended or unauthorized application, Buyer shall indemnify and hold ON Semiconductor and its officers, employees, subsidiaries, affiliates, and distributors harmless against all claims, costs, damages, and expenses, and reasonable attorney fees arising out of, directly or indirectly, any claim of personal injury or death associated with such unintended or unauthorized use, even if such claim alleges that ON Semiconductor was negligent regarding the design or manufacture of the part. ON Semiconductor is an Equal Opportunity/Affirmative Action Employer. This literature is subject to all applicable copyright laws and is not for resale in any manner.

PUBLICATION ORDERING INFORMATION

LITERATURE FULFILLMENT:

Literature Distribution Center for ON Semiconductor
19521 E. 32nd Pkwy, Aurora, Colorado 80011 USA
Phone: 303-675-2175 or 800-344-3860 Toll Free USA/Canada
Fax: 303-675-2176 or 800-344-3867 Toll Free USA/Canada
Email: orderlit@onsemi.com

N. American Technical Support: 800-282-9855 Toll Free
USA/Canada
Europe, Middle East and Africa Technical Support:
Phone: 421 33 790 2910

ON Semiconductor Website: www.onsemi.com

Order Literature: <http://www.onsemi.com/orderlit>

For additional information, please contact your local
Sales Representative